TECHNICAL CATALOG

Baldor-Reliance® Integral horsepower DC motors

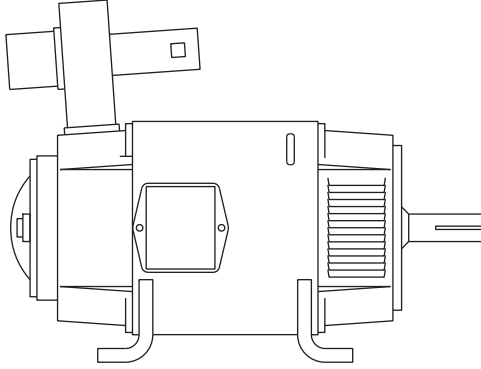



Table of contents

04	Enclosure types	30–42	Round Frame Modifications and Accessories
05	Drip Proof Fully Guarded (DPFG) and Totally Enclosed Non Vented (TENV)	43–46	Drip Proof Guarded
06	Drip Proof Blower Vented DC Motors	47–52	Drip Proof Guarded Force Ventilated
07–11	Drip Proof Fully Guarded and Drip Proof Blower Vented DC Motors	53	Totally Enclosed Fan Cooled
12–14	Totally Enclosed Motors	54–58	Totally Enclosed Non Ventilated
15–16	Totally Enclosed Air Over Motors	59–61	Totally Enclosed Explosion Proof
17–22	Drip Proof Fully Guarded Short Time Rated Motors	62–68	Paper Mill Service Motors
23–25	Totally Enclosed Non Vented Short Time Rated Motors	69	Range Drive Motors
25	Metric Frame and Elevator Rated DC Motors Drip Proof Blower Vented -Less Blower	70	Extruder Duty Motors
26	Paper Mill and Carriage Drive Motors	71	IEC DC Motors
27–28	DC Generators	72–95	Laminated Frame DC Modifications and Accessories
29	Lifting Magnet Generators		

Enclosure types



DPBV
Drip Proof Blower Vented

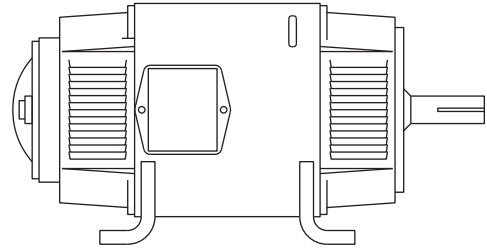

DPFG
Drip Proof Fully Guarded

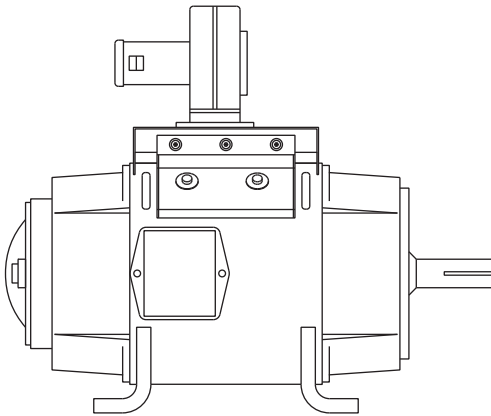

TEAO
Totally Enclosed Air Over

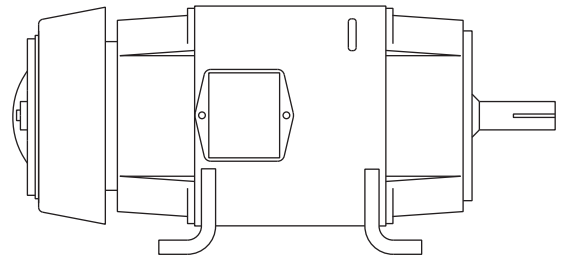

TEFC
Totally Enclosed Fan Cooled

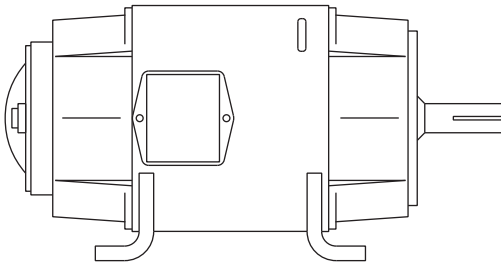

TENV
Totally Enclosed Non Vented

Drip Proof Fully Guarded (DPFG) and Totally Enclosed Non Vented (TENV)

DC Motors 180 Volt, Single Phase, 1-10 Hp

For 230 VAC, single phase, 50/60 hertz, full wave power supply, NEMA Type K, 180V armature, and 100/200 volt field.



Features:

- 20:1 constant torque speed range
- Class F temperature rise
- Accessory mounting face
- Locked bearing on commutator end
- 40°C ambient

HP	RPM	DPFG	Mult. Sym.	TENV	Mult. Sym.
1	1750	L182AT	N1	L186AT	N1
	1150	L182AT	N1	L186AT	N1
1.5	2500	L182AT	N1	L186AT	N1
	1750	L186AT	N1	L186AT	N1
	1150	L186AT	N1	L186AT	N1
2	2500	L182AT	N1	L186AT	N1
	1750	L186AT	N1	L186AT	N1
	1150	L186AT	N1	219AT	N1
3	2500	L186AT	N1	L186AT	N1
	1750	L186AT	N1	1810AT	N1
	1150	L186AT	N1	258AT	N1
5	2500	L186AT	N1	258AT	N1
	1750	1810AT	N1	259AT	N1
	1150	2110AT	N1	288AT	N1
7.5	2500	219AT	N1	258AT (TEFC)	N1
	1750	2110AT	N1	288AT	N1
10	1150	2110AT (DPBV)	N1	328AT (TEFC)	N1
	1750	259AT	N1	328AT (TEFC)	N1

Note: 180AT frame motors are available with a choice of two optional c-faces. Refer to dimension sheets in Section C for details. Specify G-lace and shaft when ordering.

Constant torque speed range to 60% of base speed is available. Contact ABB for frame size and pricing. Refer to the Modifications Section for available options.

Drip Proof Blower Vented DC Motors

240 & 500 Volt, 1-3 Hp

For 230V or 460V, three phase, 60 hertz, full wave power supply, NEMA Type C, 240V or 500V armature, 150/300V or 120/240V field.

Refer to Modification Section for available options, and Section D for constant torque speed range for drip proof fully guarded and drip proof blower vented motors.

Features

- Class F temperature rise
- Accessory mounting face
- Locked bearing on commutator end
- 40°C ambient



Hp	Base RPM	Std/Rated Top RPM	Fully Guarded		Blower Vented Less Blower		Mult. Sym.
			240V Frame	500V Frame	240V Frame	500V Frame	
1	3500	3500			L182AT		N1
	2500	3000			L182AT		N1
	1750	2300	L182AT		L182AT		N1
	1150	2000	L182AT		L182AT		N1
	850	1700	L186AT		L186AT		N1
1.5	3500	3500	L182AT		L182AT		N1
	2500	3000	L182AT		L182AT		N1
	1750	2300	L182AT		L182AT		N1
	1150	2000	L186AT		L186AT		N1
	850	1700	L186AT		L186AT		N1
2	3500	3500	L182AT	L182AT	L182AT	L182AT	N1
	2500	3000	L182AT	L182AT	L182AT	L182AT	N1
	1750	2300	L182AT	L186AT	L182AT	L186AT	N1
	1150	2000	L186AT	L186AT	L186AT	L186AT	N1
	850	1700	L186AT	L186AT	L186AT	L186AT	N1
3	3500	3500	L182AT	L182AT	L182AT	L182AT	N1
	2500	3000	L182AT	L186AT	L182AT	L186AT	N1
	1750	2300	L186AT	L186AT	L186AT	L186AT	N1
	1150	2000	L186AT	L186AT	L186AT	L186AT	N1
	850	1700	L18AT	218AT	218AT	218AT	N1
	650	1600	2110AT		2110AT		N1
	500	1500	259AT		259AT		N1
	400	1200	288AT		288AT		N1
	300	900	288AT		288AT		N1

Note: DPBV motors do not include blowers. See Modification Section for the price adder.



Drip Proof Fully Guarded and Drip Proof Blower Vented DC Motors

240 & 500 Volt, 5-15 Hp

Refer to Modification Section for available options, and Section D for constant torque speed range for drip proof fully guarded and drip proof blower vented motors.



Hp	Base RPM	Std/Rated Top RPM	Fully Guarded		Blower Vented Less Blower		Mult. Sym.
			240V Frame	500V Frame	240V Frame	500V Frame	
5	3500	3500	L186AT	L186AT	L186AT	L186AT	N2
	2500	3000	L186AT	L186AT	L186AT	L186AT	N2
	1750	2300	L186AT	L186AT	L186AT	L186AT	N2
	1150	2000	218AT	219AT	218AT	219AT	N2
	1150	2000	1810AT	1810AT	1810AT	1810AT	N2
	850	1700	2110AT	2110AT	2110AT	2110AT	N2
	650	1600	259AT		259AT		N2
	500	1500	288AT		288AT		N2
	400	1200	328AT		328AT		N2
	300	900	365AT		365AT		N2
7.5	3500	3500	L186AT	L186AT	L186AT	L186AT	N2
	2500	3000	L186AT	L186AT	L186AT	L186AT	N2
	1750	2300	1810AT	218AT	1810AT	218AT	N2
	1750	2300		1810AT		1810AT	N2
	1150	2000	2110AT	2110AT	2110AT	2110AT	N2
	850	1700	259AT	259AT	259AT	259AT	N2
	650	1600	288AT	288AT	288AT	288AT	N2
	500	1500	328AT	328AT	328AT	328AT	N2
	400	1200	365AT	366AT	365AT	366AT	N2
	300	900	368AT	368AT	368AT	368AT	N2
10	3500	3500	218AT		218AT		N2
	3500	3500			L186AT	L186AT	N2
	2500	3000	218AT	218AT	218AT	218AT	N2
	2500	3000			1810AT	1810AT	N2
	1750	2300	219AT	219AT	219AT	219AT	N2
	1150	2000	258AT	258AT	258AT	258AT	N2
	850	1700	288AT	288AT	288AT	288AT	N2
	850	1700			2510AT	2510AT	N2
	650	1600	328AT	328AT	328AT	328AT	N2
	500	1500	328AT	328AT	328AT	328AT	N2
15	400	1200	366AT	366AT	366AT	366AT	N2
	300	900	368AT	407AT	368AT	407AT	N2
	300	900				368AT	N2
	3500	3500	218AT	218AT	218AT	218AT	N2
	2500	3000	219AT	219AT	219AT	219AT	N2
	1750	2300	258AT	258AT	258AT	258AT	N2
	1150	2000	288AT	288AT	288AT	288AT	N2
	850	1700	328AT	328AT	328AT	328AT	N2
	650	1600	365AT	365AT	365AT	365AT	N2
	500	1500	368AT	368AT	368AT	368AT	N2
15	400	1200	407AT	407AT	407AT	407AT	N2
	300	900	409AT	409AT	409AT	409AT	N2
	300	900			368AT	368AT	N2
	300	900					N2

Note: DPBV motors do not include blowers. See Modification Section for the price adder.

Drip Proof Fully Guarded and Drip Proof Blower Vented DC Motors

240 & 500 Volt, 20-30 Hp

Refer to Modification Section for available options, and Section D for constant torque speed range for drip proof fully guarded and drip proof blower vented motors.



Hp	Base RPM	Std/Rated Top RPM	Fully Guarded		Blower Vented Less Blower		
			240V Frame	500V Frame	240V Frame	500V Frame	Mult. Sym.
20	3500	3500	219AT	219AT	219AT	219AT	N2
	2500	3000	2110AT	2110AT	2110AT	2110AT	N2
	1750	2300	259AT	259AT	259AT	259AT	N2
	1150	2000	328AT	328AT	328AT	328AT	N2
	850	1700	328AT	328AT	328AT	328AT	N2
	650	1600	366AT	366AT	366AT	366AT	N2
	500	1500	368AT	407AT	366AT	366AT	N2
	400	1200	407AT	407AT	368AT	368AT	N2
	300	900	504AT	508AT	504AT	407AT	N2
	300	900			3610AT	3610AT	N2
25	3500	3500	258AT	258AT	258AT	258AT	N2
	2500	3000	258AT	258AT	258AT	258AT	N2
	1750	2300	288AT	287-288AT	288AT	287-288AT	N2
	1750	2300			2510AT	2510AT	N2
	1150	2000	328AT	328AT	328AT	328AT	N2
	850	1700	365AT	366AT	365AT	366AT	N2
	850	1700			329AT	329AT	N2
	650	1600	368AT	368AT	366AT	366AT	N2
	500	1500	407AT	409AT	368AT	368AT	N2
	400	1200	409AT	409AT	409AT	409AT	N2
30	400	1200			3610AT	368AT	N2
	300	900	504AT	508AT	504AT	508AT	N2
	3500	3500	288AT	259AT	288AT	259AT	N2
	2500	3000	288AT	288AT	288AT	259AT	N2
	1750	2300	288AT	288AT	288AT	288AT	N2
	1750	2300			2513AT	2513AT	N2
	1150	2000	365AT	365AT	328AT	328AT	N2
	850	1700	366AT	366AT	365AT	365-6AT	N2
	650	1600	407AT	407AT	365AT	366AT	N2
	500	1500	407AT	407AT	368AT	407AT	N2
	500	1500				368AT	N2
	400	1200	504AT	506AT	504AT	506AT	N2
	400	1200			3610AT	3610AT	N2
	300	900	506AT	506AT	506AT	506AT	N2

Note: DPBV motors do not include blowers. See Modification Section for the price adder.

Drip Proof Fully Guarded and Drip Proof Blower Vented DC Motors

240 & 500 Volt, 40-60 Hp

Refer to Modification Section for available options, and Section D for constant torque speed range for drip proof fully guarded and drip proof blower vented motors.



Hp	Base RPM	Std/Rated Top RPM	Fully Guarded		Blower Vented Less Blower		Mult. Sym.	
			240V Frame	500V Frame	240V Frame	500V Frame		
40	3500	3500	288AT	288AT	288AT	288AT	N2	
	2500	3000	288AT	288AT	288AT	288AT	N2	
	1750	2300	328AT	328AT	328AT	328AT	N2	
	1750	2300			2810AT	2810AT	N2	
	1150	2000	366AT	366AT	366AT	365AT	N2	
	1150	2000			329AT	329AT	N2	
	850	1700	368AT	368AT	366AT	366AT	N2	
	650	1600	409AT	407AT	368AT	368AT	N2	
	500	1500	504AT	504AT	504AT	504AT	N2	
	500	1500			3610AT	3610AT	N2	
	400	1200	504AT	504AT	504AT	504AT	N2	
	300	900	508AT	508AT	508AT	508AT	N2	
	50	3500	3500				288AT	N2
2500		2700	327AT	288AT	327AT	288AT	N2	
1750		2100	328AT	328AT	328AT	328AT	N2	
1750		2100			2813AT	2813AT	N2	
1150		2000	368AT	368AT	366AT	366AT	N2	
850		1700	407AT	407AT	368AT	368AT	N2	
650		1600	504AT	409AT	504AT	409AT	N2	
650		1600			3610AT	3610AT	N2	
500		1500	506AT	506AT	506AT	506AT	N2	
500		1500			3610AT	3610AT	N2	
400		1200	508AT	508AT	506AT	506AT	N2	
60		3500	3500				328AT	N2
		2500	2700	328AT	328AT	328AT	328AT	N2
	1750	2100	366AT	365-366AT	366AT	365-366AT	N2	
	1750	2100			329AT	329AT	N2	
	1150	2000	407AT	368AT	368AT	368AT	N2	
	850	1700	409AT	407AT	368AT	368AT	N2	
	650	1600	504AT	504AT	504AT	504AT	N2	
	650	1600			3610AT	3610AT	N2	
	500	1500	506AT	506AT	506AT	506AT	N2	
	400	1200			506AT	506AT	N2	
	300	900			506AT	506AT	N2	

Note: DPBV motors do not include blowers. See Modification Section for the price adder.

Drip Proof Fully Guarded and Drip Proof Blower Vented DC Motors

240 & 500 Volt, 75-125 Hp

Refer to Modification Section for available options, and Section D for constant torque speed range for drip proof fully guarded and drip proof blower vented motors.



Hp	Base RPM	Std/Rated Top RPM	Fully Guarded				Blower Vented Less Blower	
			240V Frame	500V Frame	240V Frame	500V Frame	Mult. Sym.	Special Blower
75	3500	3500				328AT	N2	
	2500	2700	365AT	329AT	365AT	329AT	N2	
	1750	2100	366AT	366AT	366AT	366AT	N2	
	1750	2100			365AT		N2	
	1150	2100	407AT	407AT	368AT	368AT	N2	
	850	1700	504AT	409AT	407AT	407AT (1)	N2	
	850	1700			3610AT	3610AT	N2	
	650	1600	506AT	506AT	504AT	504AT	N2	
	500	1500	508AT	508AT	506AT	506AT	N2	LM9
	400	1200			506AT	506AT	N2	
100	3500	3500				366AT	N2	
	2500	2700				366AT	N2	
	1750	2000	368AT	368AT	368AT	368AT	N2	
	1150	2000	409AT	409AT	409AT	407AT	N2	
	1150	2000			3610AT	3610AT	N2	
	850	1700	504AT	506AT	504AT	409AT	N2	
	650	1600	508AT	508AT	506AT	506AT	N2	
	500	1500			508AT	508AT	N2	
	400	1200			5010AT	5010AT	N2	
	125	3500	3500				366AT	N2
2500		2700				368AT	N2	
1750		2000	L407AT	407AT	L407AT	368AT	N2	
1150		2000	504AT	506AT	L409AT	409AT	N2	
1150		2000				3612AT	N2	LM9
850		1700	506AT	506AT	506AT	506AT	N2	
650		1600	508AT	506AT	508AT	506AT	N2	
500		1500			508AT	508AT	N2	
400		1200			5010AT	5010AT	N2	

Note: DPBV motors do not include blowers. See Modification Section for the price adder.

(1) Power Code C



Drip Proof Fully Guarded and Drip Proof Blower Vented DC Motors

240 & 500 Volt, 150-500 Hp

Refer to Modification Section for available options, and Section D for constant torque speed range for drip proof fully guarded and drip proof blower vented motors.



Hp	Base RPM	Std/Rated Top RPM	Fully Guarded				Blower Vented Less Blower	
			240V Frame	500V Frame	240V Frame	500V Frame	Mult. Sym.	Special Blower
150	3500	3500				366AT	N2	
	2500	2700				407AT	N2	
	2500	2700				368AT	N2	
	1750	2000	L409AT	409AT	L409AT	407AT	N2	
	1750	2000				368AT	N2	LM9
	1150	2000	506AT	506AT	506AT	506AT	N2	
	850	1700	508AT	508AT	506AT	506AT	N2	
	650	1600			506AT	506AT	N2	LM9
	500	1500			5010AT	508AT	N2	
	400	1200			5011AT	5010AT	N2	
200	2500	2875				409AT	N2	
	1750	2000	504AT	504AT	504AT	409AT	N2	
	1750	2000				3610AT	N2	LM9
	1150	1800	508AT	508AT	506AT	506AT	N2	LM9
	850	1700				508AT	N2	
	650	1600			5010AT	508AT	N2	
	500	1500			5011AT	5011AT	N2	
250	1750	1900	506AT	506AT		504AT	N2	
	1150	1700				506AT	N2	
	850	1600				5010AT	N2	
	650	1600				5011AT	N2	
300	1750	1900				506AT	N2	
	1150	1600				508AT	N2	
	850	1500				5010AT	N2	
	650	1500				5011AT	N2	
400	1750	1900				508AT	N2	
	1150	1500				5010AT	N2	
500	1750	1900				5010AT	N2	
	1150	1500				5011AT	N2	

Totally Enclosed Motors

240 & 500 Volt, 1-3 Hp

For 230 and 460 volt, three phase, 60 hertz, full wave power supply, NEMA Type C, 240V or 500V armature, and 150/300V or 120/240V field.

- TENV (Totally Enclosed Non-Vented)
- TEFC (Totally Enclosed Fan Cooled)

Features

- Class F temperature rise
- Accessory mounting face
- Locked bearing on commutator end
- 40°C ambient



Hp	Base RPM	Std/Rated Top RPM	240V Frame	500V Frame	Enclosure Type	Mult. Sym.
1	1750	2300	L182AT		TENV	N1
	1150	2000	L182AT		TENV	N1
	850	1700	L186AT		TENV	N1
	650	1600	218AT		TENV	N1
	500	1500	219AT		TENV	N1
	400	1200	219AT		TENV	N1
1.5	3500	3850	L182AT		TENV	N1
	2500	3000	L182AT		TENV	N1
	1750	2300	L186AT		TENV	N1
	1150	2000	L186AT		TENV	N1
	850	1700	L1810AT		TENV	N1
	650	1600	219AT		TENV	N1
2	500	1500	258AT		TENV	N1
	400	1200	258AT		TENV	N1
	3500	3850	L186AT		TENV	N1
	2500	3000	L186AT	L186AT	TENV	N1
	1750	2300	L186AT	L186AT	TENV	N1
	1150	2000	1810AT	1810AT	TENV	N1
3	850	1700	219AT	219AT	TENV	N1
	650	1600	2110AT		TENV	N1
	500	1500	258AT		TENV	N1
	400	1200	259AT		TENV	N1
	300	900	328AT		TENV	N1
	3500	3850	L186AT		TENV	N1
3	2500	3000	L186AT	L186AT	TENV	N1
	1750	2300	L186AT	L186AT	TENV	N1
	1150	2000	1810AT	1810AT	TEFC	N1
	850	1700	2110AT	2110AT	TENV	N1
	650	1600	259AT		TENV	N1
	500	1500	288AT		TENV	N1
3	400	1200	288AT		TENV	N1
	300	900	328AT		TENV	N1

Note: Refer to Modification Section for available options and CA608D for constant torque speed range.

Totally Enclosed Motors

240 & 500 Volt, 5-20 Hp

Enclosure types

- TENV (Totally Enclosed Non-Vented)
- TEFC (Totally Enclosed Fan Cooled)



Hp	Base RPM	Std/Rated Top RPM	240V Frame	500V Frame	Enclosure Type	Mult. Sym.
5	3500	3850	L186AT		TENV	N2
	2500	3000	L186AT	L186AT	TEFC	N2
	1750	2300	1810AT	1810AT	TEFC	N2
	1150	2000	258AT	258AT	TENV	N2
	850	1700	259AT	259AT	TENV	N2
	650	1600	288AT		TENV	N2
	500	1500	328AT		TENV	N2
	400	1200	365AT		TEFC	N2
	300	900	368AT		TEFC	N2
7.5	3500	3500	L186AT		TEFC	N2
	2500	3000	1810AT	1810AT	TEFC	N2
	1750	2300	2110AT	2110AT	TEFC	N2
	1150	2000	259AT	259AT	TEFC	N2
	850	1700	288AT	288AT	TEFC	N2
	650	1600	328AT	328AT	TEFC	N2
	500	1500	365AT		TEFC	N2
	400	1200	368AT		TEFC	N2
	300	900	407AT		TEFC	N2
10	3500	3500	219AT		TEFC	N2
	2500	3000	2110AT	2110AT	TEFC	N2
	1750	2300	259AT	259AT	TEFC	N2
	1150	2000	288AT	288AT	TEFC	N2
	850	1700	328AT	328AT	TEFC	N2
	650	1600	365AT	365AT	TEFC	N2
	500	1500	368AT		TEFC	N2
	400	1200	407AT		TEFC	N2
	3500	3500	258AT		TEFC	N2
15	2500	3000	259AT	259AT	TEFC	N2
	1750	2300	288AT	288AT	TEFC	N2
	1150	2000	328AT	328AT	TEFC	N2
	850	1700	365AT	365AT	TEFC	N2
	650	1600	368AT	368AT	TEFC	N2
	500	1500	407AT	407AT	TEFC	N2
	400	1200	409AT	409AT	TEFC	N2
	3500	3500	288AT	288AT	TEFC	N2
	2500	3000	288AT	288AT	TEFC	N2
20	1750	2300	328AT	328AT	TEFC	N2
	1150	2000	366AT	366AT	TEFC	N2
	850	1700	368AT	368AT	TEFC	N2
	650	1600	407AT	407AT	TEFC	N2
	500	1500	409AT	409AT	TEFC	N2

Note: Refer to Modification Section for available options and CA608D for constant torque speed range.

Totally Enclosed Motors

240 & 500 Volt, 25-75 Hp

Enclosure types

- TENV (Totally Enclosed Non-Vented)
- TEFC (Totally Enclosed Fan Cooled)



Hp	Base RPM	Std/Rated Top RPM	240V Frame	500V Frame	Enclosure Type	Mult. Sym.
25	2500	3000	328AT	328AT	TEFC	N2
	1750	2300	328AT	328AT	TEFC	N2
	1150	2000	368AT	368AT	TEFC	N2
	850	1700	407AT	407AT	TEFC	N2
	650	1600	409AT	409AT	TEFC	N2
30	2500	3000	365AT	365AT	TEFC	N2
	1750	2300	366AT	366AT	TEFC	N2
	1150	2000	407AT	368AT	TEFC	N2
	850	1700	409AT	409AT	TEFC	N2
40	2500	3000	366AT	366AT	TEFC	N2
	1750	2100	368AT	368AT	TEFC	N2
	1150	2000	407AT	407AT	TEFC	N2
	850	1700	409AT	409AT	TEFC	N2
50	1750	2100	407AT	407AT	TEFC	N2
	1150	2000	409AT	409AT	TEFC	N2
60	1750	2100	409AT	409AT	TEFC	N2
75	1750	2100	409AT	409AT	TEFC	N2

Note: Refer to Modification Section for available options and CA608D for constant torque speed range.

Totally Enclosed Air Over Motors

240 & 500 Volt, 5-15 Hp

For 230 and 460 volt, three phase,
60 hertz, full wave power supply,
NEMA Type C, 240V or 500V armature,
and 150/300V or 120/240V field.

Enclosure types

- Class F temperature rise
- Accessory mounting Face
- Locked bearing on commutator end
- 40°C ambient
- Pricing includes TEAO blower

Hp	Base RPM	Std/Rated Top RPM	240V Frame	500V Frame	Mult. Sym.
5	1750	2300	2110AT	2110AT	N2
	1150	2000	258AT	258AT	N2
	850	1700	259AT	259AT	N2
	650	1600	288AT		N2
	500	1500	328AT		N2
	400	1200	365AT		N2
	300	900	368AT		N2
7.5	1750	2300	2110AT	2110AT	N2
	1150	2000	259AT	259AT	N2
	850	1700	288AT	288AT	N2
	650	1600	328AT	328AT	N2
	500	1500	365AT		N2
	400	1200	368AT		N2
	300	900	407AT		N2
10	2500	3000	2110AT	2110AT	N2
	1750	2300	259AT	259AT	N2
	1150	2000	288AT	288AT	N2
	850	1700	328AT	328AT	N2
	650	1600	365AT	365AT	N2
	500	1500	368AT		N2
	400	1200	407AT		N2
15	3500	3500	258AT		N2
	2500	3000	259AT	259AT	N2
	1750	2300	288AT	288AT	N2
	1150	2000	328AT	328AT	N2
	850	1700	365AT	365AT	N2
	650	1600	368AT	368AT	N2
	500	1500	407AT	407AT	N2
	400	1200	409AT	409AT	N2

Note: Refer to Modification Section for available options and CA608D for constant torque speed range.

Totally Enclosed Air Over Motors

240 & 500 Volt, 20-100 Hp

For 230 and 460 volt, three phase,
60 hertz, full wave power supply,
NEMA Type C, 240V or 500V armature,
and 150/300V for 120/240V field.

Enclosure types

- Class F temperature rise
- Accessory mounting face
- Locked bearing on commutator end
- 40°C ambient
- Pricing includes TEAO blower

Hp	Base RPM	Std/Rated Top RPM	240V Frame	500V Frame	Mult. Sym.
20	2500	3000	288AT	288AT	N2
	1750	2300	328AT	328AT	N2
	1150	2000	366AT	366AT	N2
	850	1700	368AT	368AT	N2
	650	1600	407AT	407AT	N2
25	500	1500	409AT	409AT	N2
	2500	3000	328AT	328AT	N2
	1750	2300	328AT	328AT	N2
	1150	2000	368AT	368AT	N2
	850	1700	407AT	407AT	N2
30	650	1600	409AT	409AT	N2
	2500	3000	365AT	365AT	N2
	1750	2300	366AT	366AT	N2
	1150	2000	407AT	368AT	N2
	850	1700	409AT	409AT	N2
40	650	1600	409AT	409AT	N2
	2500	3000	366AT	366AT	N2
	1750	2100	368AT	368AT	N2
	1150	2000	407AT	407AT	N2
	850	1700	409AT	409AT	N2
50	650	1600	504AT	504AT	N2
	1750	2100	407AT	407AT	N2
	1150	2000	409AT	409AT	N2
	850	1700	506AT	506AT	N2
	650	1600	508AT	506AT	N2
60	1750	2100	409AT	409AT	N2
	1150	2000	504AT	504AT	N2
	850	1700	506AT	506AT	N2
	650	1600	508AT	508AT	N2
	1750	2100	409AT	409AT	N2
75	1150	2000	504AT	506AT	N2
	850	1700	506AT	508AT	N2
100	1750	2100		506AT	N2

Note: Refer to Modification Section for available options and CA608D for constant torque speed range.

Drip Proof Fully Guarded Short Time Rated Motors

240 Volt

The NEMA definition for short time rated motors is as follows: "All short time ratings are based upon corresponding short time load tests which shall commence only when the windings and other parts of the machine are within 5°C of the ambient temperature at the time of starting the test".

This also means that the field voltage should be removed when the motor is not operating.

240V - Drip proof fully guarded short time rated - shunt wound DC motors for operation from three phase, NEMA type C or D, rectified power supply with 230V nominal AC input voltage or MG set power supplies.



Base Speed	240V Frame Size	Cont. Hp	Short Time Rated Hp						Mult. Sym.
			DPFG			DPBV (Less Blower)			
			1 Hr	30 Min.	15 Min.	1 Hr	30 Min.	15 Min.	
1750	L186AT	3	3	3	5	3	3	5	N2
	L186AT	5	5	5	7.5	5	5	7.5	N2
	218AT	7.5	7.5	7.5	10	7.5	7.5	10	N2
	219AT	10	10	10		10	10		N2
	258AT	15	15	15	20	15	15	20	N2
	259AT	20	20	25	30	20	20	30	N2
	288AT	30	30	40	40	30	30	40	N2
	328AT	40	40	50	50	40	40	50	N2
	328AT	50	60	60	75	60	60	75	N2
	366AT	60		75			75		N2
	366AT	75	75	100	100	75	100	100	N2
	368AT	100	100		125	100		125	N2
	L407AT	125	125	125	150	125	125	150	N2
	L409AT	150	150	150	200	150	150	200	N2
	504AT	200	250	300	300	250	300	300	N2
	506AT	250			400			400	N2
508AT	300	300	400	500	300	400	500	N2	
1150	L186AT	3	3	3	5	3	3	5	N1
	218AT	5	5	5	7.5	5	5	7.5	N2
	2110AT	7.5	7.5	10	10	7.5	10	10	N2
	258AT	10	10		15	10		15	N2
	288AT	15	15	20	20	15	20	25	N2
	328AT	20	25	25	30	25	25	30	N2
	328AT	25	30	30	40	30	30	40	N2
	365AT	30	40	40	50	40	50	50	N2
	366AT	40	50	50	60	50	60	60	N2
	368AT	50	60	60	75	60	75	75	N2
	407AT	60	75	75	100	75		100	N2
	407AT	75	100	100	125	100	100	125	N2
	409AT	100		125			125	150	N2
	504AT	125	150	200	250	150	200	250	N2
	506AT	150	200	250	300	200	250	300	N2
	508AT	200	250	300	400	250	300	400	N2

Drip Proof Fully Guarded Short Time Rated Motors

240 Volt

240V - Drip proof fully guarded short time rated - shunt wound DC motors for operation from three phase, NEMA type C or D, rectified power supply with 230V nominal AC input voltage or MG set power supplies.



Base Speed	240V Frame Size	Cont. Hp	Short Time Rated Hp						Mult. Sym.
			DPFG			DPBV (Less Blower)			
			1 Hr	30 Min.	15 Min.	1 Hr	30 Min.	15 Min.	
850	218AT	3	3	3	5	3	3	5	N1
	2110AT	5	5	5	7.5	5	7.5	7.5	N1
	259AT	7.5	10	10	10	10	10	15	N2
	288AT	10			15		15	20	N2
	328AT	15	20	20	25	20	20	25	N2
	328AT	20	25	25	30	25	30	30	N2
	365AT	25	30	30	40	40	40	50	N2
	366AT	30	40	40	50	50	50	60	N2
	368AT	40	50	50	60	60	60	75	N2
	407AT	50	60	60	75	75	75	75	N2
	409AT	60	75	75	100		100	100	N2
	504AT	75	100	125	125	100	125	125	N2
	504AT	100	125	150	150	125	150	150	N2
	506AT	125	150	200	200	150	200	200	N2
	508AT	150	200	250	250	200	250	250	N2
650	2110AT	3	3	3	5	3	5	5	N2
	259AT	5	5	7.5	7.5	7.5	7.5	7.5	N2
	288AT	7.5	10	10	15	10	10	15	N2
	328AT	10		15		15	15		N2
	365AT	15	20	25	25	25	25	30	N2
	366AT	20	25	30	30	30	40	40	N2
	368AT	25	30	40	40	40	40	50	N2
	407AT	30	40	50	50		50	60	N2
	409AT	40	50	60	60	60	60	75	N2
	504AT	50	60	75	100	75	75	100	N2
	504AT	60	75	100	125	100	100	125	N2
	506AT	75	100	125	150		125	150	N2
	508AT	100	150	150	200	150	150	200	N2

Drip Proof Fully Guarded Short Time Rated Motors

240 Volt

240V - Drip proof fully guarded short time rated - shunt wound DC motors for operation from three phase, NEMA type C or D, rectified power supply with 230V nominal AC input voltage or MG set power supplies.



Base Speed	240V Frame Size	Cont. Hp	Short Time Rated Hp						Mult. Sym.
			DPFG			DPBV (Less Blower)			
			1 Hr	30 Min.	15 Min.	1 Hr	30 Min.	15 Min.	
500	259AT	3	5	5	5	5	5	5	N2
	288AT	5	7.5	7.5	10	7.5	7.5	10	N2
	328AT	7.5	10	10		10	10	15	N2
	328AT	10		15	15	15	15	20	N2
	368AT	15	20	25	25	25	25	30	N2
	368AT	20	25	30	30	30	30	40	N2
	407AT	25			40		40	50	N2
	407AT	30	30	40	50	40	50	60	N2
	504AT	40	60	60	75	60	75	75	N2
	506AT	50							N2
	506AT	60	75	75	100	75	100	100	N2
	508AT	75	100	125	150	125	150	150	N2
400	288AT	3	3	5	5	5	5	5	N2
	328AT	5	7.5	7.5	10	7.5	7.5	10	N2
	365AT	7.5	10	10	15	10	15	15	N2
	366AT	10	15	15	20	15	20	20	N2
	407AT	15	20	25	25	25	25	30	N2
	407AT	20	25	30	30	30	30	40	N2
	409AT	25	30	40	40	40	40	50	N2
	504AT	30	50	50	60	50	60	60	N2
	506AT	40	60	60	75	60	75	75	N2
	508AT	50		75		75		100	N2
	508AT	60	75	100	100	100	100	125	N2
	365AT	5	7.5	7.5	10	7.5	10	10	N2
300	368AT	7.5		10		10	15	15	N2
	368AT	10	10	15	15	15	20	20	N2
	409AT	15	25	25	30	25	30	30	N2
	504AT	20		30	40	30		40	N2
	504AT	25	30	40	50	40	40	50	N2
	506AT	30	40	50	60	50	60	60	N2

Drip Proof Fully Guarded Short Time Rated Motors

500 Volt

The NEMA definition for short time rated motors is as follows: "All short time ratings are based upon corresponding short time load tests which shall commence only when the windings and other parts of the machine are within 5°C of the ambient temperature at the time of starting the test".

This also means that the field voltage should be removed when the motor is not operating.

500V - Drip proof fully guarded short time rated - shunt wound DC motors for operation from three phase, NEMA type C or D, rectified power supply with 460V nominal AC input voltage or MG set power supplies.



Base Speed	240V Frame Size	Cont. Hp	Short Time Rated Hp						Mult. Sym.
			DPFG			DPBV (Less Blower)			
			1 Hr	30 Min.	15 Min.	1 Hr	30 Min.	15 Min.	
1750	L186AT	3	3	3	5	3	3	5	N1
	L186AT	5	5	5	7.5	5	5	7.5	N2
	218AT	7.5	7.5	7.5	10	7.5	7.5	10	N2
	219AT	10	10	10		10	10		N2
	258AT	15	15	15	20	15	15	20	N2
	259AT	20	20	20	25	20	20	25	N2
	288AT	25	25	30	30	25	30	30	N2
	288AT	30	30		40	30		40	N2
	328AT	40	40	40	50	40	40	50	N2
	328AT	50	50	60	60	50	60	60	N2
	366AT	60	60	75	75	60	75	75	N2
	366AT	75	75	100	100	75	100	100	N2
	368AT	100	100	125	125	100	125	125	N2
	407AT	125	125	150	150	125	150	150	N2
	409AT	150	150		200	150		200	N2
504AT	200	250	300	300	250	300	300	N2	
506AT	250	300						N2	
506AT	300		400	500	300	400	500	N2	
1150	L186AT	3	3	3	5	3	3	5	N1
	219AT	5	5	5		5	5	7.5	N2
	2110AT	7.5	7.5	10	10	7.5	10	10	N2
	258AT	10	10		15	10		15	N2
	288AT	15	15	20	20	15	20	20	N2
	328AT	20	25	25	30	25	25	30	N2
	328AT	25	30	30	40	30	30	40	N2
	365AT	30	40	40	50	40	40	50	N2
	366AT	40	50	50	60	50	60	60	N2
	368AT	50	60	60	75	60	75	75	N2
	368AT	60		75		75			N2
	407AT	75	100	100	100	100	100	100	N2
	409AT	100	125	125	150	125	125	150	N2
	506AT	125	150	200	250	150	200	250	N2
	506AT	150	200	250	300	200	250	300	N2
508AT	200						400	N2	
508AT	250	250	300	300	250	300		N2	

Drip Proof Fully Guarded Short Time Rated Motors
500 Volt continued...

Base Speed	240V Frame Size	Cont. Hp	Short Time Rated Hp						Mult. Sym.
			DPFG			DPBV (Less Blower)			
			1 Hr	30 Min.	15 Min.	1 Hr	30 Min.	15 Min.	
850	218AT	3	3	3	5	3	3	5	N1
	2110AT	5	5	5	7.5	5	7.5	7.5	N2
	259AT	7.5	10	10	10	10	10	10	N2
	288AT	10			15			15	N2
	328AT	15	20	20	25	20	20	25	N2
	328AT	20	25	25	30	25	30	30	N2
	366AT	25	30	30	40	40	40	50	N2
850	366AT	30	40	40	50	50	50	60	N2
	368AT	40	50	50	60	60	60	75	N2
	407AT	50	60	75	75		75		N2
	409AT	60	75		100	75		100	N2
	409AT	75		100	125	100	100	125	N2
	506AT	100	150	150	200	150	150	200	N2
	508AT	125		200	250		200	250	N2
650	508AT	150	200	250	300	200	250	300	N2
	2110AT	3	3	3	5	3	5	5	N2
	259AT	5	5	7.5	7.5	7.5	7.5	7.5	N2
	288AT	7.5	10	10	10	10	10	10	N2
	328AT	10		15	15	15	15	15	N2
	365AT	15	20	25	25	25	25	25	N2
	366AT	20	25	30	30	30	30	40	N2
	368AT	25	30	40	40	40	40	50	N2
	407AT	30	40	50	50		50	60	N2
	407AT	40	60	60	60	60	75		N2
	409AT	50		75	75	75	75	75	N2
	504AT	60	100	100	125	100	100	125	N2
	506AT	75		125		125	125		N2
	508AT	100	150	150	200	150	150	200	N2

Drip Proof Fully Guarded Short Time Rated Motors

500 Volt continued...

Base Speed	240V Frame Size	Cont. Hp	Short Time Rated Hp						Mult. Sym.
			DPFG			DPBV (Less Blower)			
			1 Hr	30 Min.	15 Min.	1 Hr	30 Min.	15 Min.	
500	259AT	3	5	5	5	5	5	5	N2
	288AT	5	7.5	7.5		7.5	7.5	10	N2
	328AT	7.5	10	10	10	10		15	N2
	328AT	10		15	15	15	15	20	N2
	368AT	15	25	25	30	25	30	30	N2
	407AT	20	30						N2
	409AT	25	40	40	50	40	50	50	N2
	409AT	30	50	50	60	50	60	60	N2
	504AT	40	60	60	75	60	75	75	N2
	506AT	50		75					N2
	506AT	60	75	100	100	75	100	100	N2
	508AT	75	125	125	150	125	150	150	N2
	400	288AT	3	3	5	5	5	5	5
328AT		5	7.5	7.5	10	7.5	7.5	10	N2
366AT		7.5	10	10	15	10	15	15	N2
366AT		10	15	15		15	20	20	N2
407AT		15	20	25	25	25	30	30	N2
407AT		20	25	30	30	30	40	40	N2
409AT		25	30	40	40	40		50	N2
506AT		30	50	50	60	50	60	60	N2
506AT		40	60	60	75	60	75	75	N2
508AT		50	75	75	100	75		100	N2
300	508AT	60	100	100	125	100	125	125	N2
	365AT	5	7.5	7.5	10	7.5	10	10	N2
	368AT	7.5	10	10	15	10	15	15	N2
	407AT	10	15	15	20	15	20	20	N2
	409AT	15	25	25	30	25	30	30	N2
	508AT	20	30	30	40	30	40	40	N2
	508AT	25	40	40	50	40	50	50	N2
	508AT	30		50		50		60	N2
	508AT	40	50	60	60	60	60	75	N2

Totally Enclosed Non Vented Short Time Rated Motors

240 or 500 Volt

The NEMA definition for short time rated motors is as follows: "All short time ratings are based upon corresponding short time load tests which shall commence only when the windings and other parts of the machine are within 5ac of the ambient temperature at the time of starting the test." This also means that the field voltage should be removed when the motor is not operating.

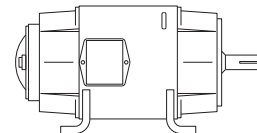

240 or 500V - TENV short time rated-shunt wound DC motors for operation from three phase NEMA type C or D. Rectified power supply with 230V or 460V nominal AC input voltage or MG set power supplies.

Base Speed	Frame	Cont. Hp	1 Hr	30 Min.	Mult. Sym.
2500	L182AT	1.5	2	3	N2
	L186AT	2			N2
	L186AT	3	3	5	N2
	219AT	5	7.5	7.5	N2
	258AT		10	15	N2
	259AT	7.5			N2
	288AT		15	25	N2
	328AT	10	20	30	N2
	365AT		30	50	N2
1750	L182AT	0.75	1	1	N2
	L182AT	1	2	2	N2
	L186AT	1.5	3	3	N2
	L186AT	2			N2
	1810AT	3	5	5	N2
	2110AT	5	7.5	10	N2
	258AT		10		N2
	259AT	7.5		15	N2
	288AT		15	20	N2
	328AT	10	20	25	N2
	328AT	15	25	30	N2
	365AT		30	50	N2
	366AT	20	50	75	N2
	366AT	20	50	75	N2
	368AT	25	75	100	N2
L407AT	40	100	125	N2	
L409AT	50	125	150	N2	
504AT	60		200	N2	
506AT	75	150	300	N2	
1150	L182AT	0.75	1	1.5	N2
	L182AT	1	1.5		N2
	L186AT	1.5	2	2	N2
	1810AT	2	3	3	N2
	258AT	3		5	N2
	258AT	5	5	7.5	N2
	259AT		10	10	N2
	288AT	7.5		15	N2
	328AT	10	15	20	N2
	365AT		25	30	N2

Totally Enclosed Non Vented Short Time Rated Motors

240 or 500 Volt continued...

240 or 500V - TENV short time rated-shunt wound DC motors for operation from three phase NEMA type C or D. Rectified power supply with 230V or 460V nominal AC input voltage or MG set power supplies.

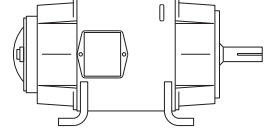

Base Speed	Frame	Cont. Hp	1 Hr	30 Min.	Mult. Sym.	
1150	366AT		40	50	N2	
	368AT	15	50	60	N2	
	407AT		60	75	N2	
	L407AT		75	100	N2	
	L409AT		100	125	N2	
	504AT		125	150	N2	
	506AT		150	200	N2	
	508AT		200	300	N2	
	L186AT	0.75	1	1	N2	
	L186AT	1	1.5	1.5	N2	
850	1810AT	1.5	2	2	N2	
	219AT	2	3	3	N2	
	2110AT	3		5	N2	
	259AT	5	5	7.5	N2	
	288AT		10	10	N2	
	328AT	7.5		15	N2	
	365AT		20	25	N2	
	366AT	10	30	40	N2	
	368AT		40	50	N2	
	407AT		50	60	N2	
	L409AT	25	60	75	N2	
	504AT		75	100	N2	
	506AT	30	125	150	N2	
	508AT		150	200	N2	
	L186AT	0.75	1	1	N2	
	650	218AT	1	1.5	2	N2
		219AT	1.5	2		N2
		2110AT	2	3	3	N2
259AT		3	5	5	N2	
288AT		5		7.5	N2	
328AT			10	10	N2	
365AT			15	20	N2	
366AT			20	25	N2	
368AT			25	30	N2	
407AT			40	50	N2	
409AT			50	60	N2	
504AT			60	75	N2	
506AT			75	100	N2	
508AT			125	150	N2	

Totally Enclosed Non Vented Short Time Rated Motors

240 or 500 Volt continued...

Base Speed	Frame	Cont. Hp	1 Hr	30 Min.	Mult. Sym.
500	219AT	1	1.5	2	N2
	258AT	2		3	N2
	288AT	3	3	5	N2
	328AT	5	5	7.5	N2
400	219AT	1	1.5	2	N2
	258AT	1.5	2		N2
	259AT	2	3	3	N2
	288AT	3		5	N2
300	328AT	2	3	3	N2
	328AT	3		5	N2

Metric Frame and Elevator Rated DC Motors Drip Proof Blower Vented - Less Blower

Metric Frame Motors

Features

- Class F temperature rise
- Accessory mounting face
- Locked bearing on commutator end
- 40°C ambient

Refer to Modification Section for available options, and Section D for constant torque speed range on drip proof-blower vented motors. DPBV motors do not include blowers. See Modification Section for the price adder.

kW	Equiv. Hp	Base Speed RPM	Rated Top Speed RPM	Metric Frame	Baldor Type	Voltage		Mult. Sym.
						Armature	Field	
4.7	6.3	1750	2300	132	218	460	360	N2
7	9.4	1750	2300	132	219	460	360	N2
11.4	15.3	1750	2300	132	2112	460	360	N2
18.5	24.8	1750	2300	160	2513	460	360	N2
29.4	39.4	1750	2300	180	2810	460	360	N2
33.6	45	1750	2100	180	2813	460	360	N2
40.3	54	1750	2100	200	329	460	360	N2
50.7	68	1750	2100	200	329	460	360	N2
74.6	100	1750	2000	200	3212	460	360	N2
93.2	125	1750	2000	225	368	460	360	N2
112	150	1750	2000	225	368	460	360	N2
149.2	200	1750	2000	225	3610	460	360	N2
186.5	250	1750	1900	250	4011	460	360	N2

Paper Mill and Carriage Drive Motors

Paper Mill Motors

Special DC motors designed for use in paper mills are available from ABB. Since these are made to order, you may choose the popular options that you require for your facility.

These are commonly added to our Totally Enclosed Non-vented (TENV), Totally Enclosed Fan-cooled (TEFC), Totally Enclosed Air-over, (TEAO), or Totally Enclosed Pipe-vented, (TEPV) designs. These motors typically have a Class F temperature rise (standard Class H+ insulation), or choose a design with only a Class B rise. Contact your local ABB Sales Office for further details.

Common paper mill options are:

- 8.2 Oversize conduit box
- 10.2 Transparent brush covers to allow brush inspection without disassembly of the motor
- 11 .8 Baldor-Reliance Dirty Duty construction
- 25.2 Inpro® shaft seal on the drive or commutator end
- 27.1 Shaft grounding brush
- 38.0 Thermostat on interpole coil
- 38.1 . Warning thermostat on interpole coil
- Special brushes as required for the application if chlorine is present.

Carriage Drive Motors

ABB offers a line of low inertia DC motors specifically designed to meet the demanding applications in the lumber industry. The motors' inherent low inertia allows the load to be rapidly accelerated and decelerated at rates faster than typical industry standard designs. These rugged motors have been application proven over several years. Designs are Drip Proof Blower-Vented (DPBV) and have a 500V armature and 150/300V field. Some typical designs are listed below. If the rating needed is not shown, contact your local ABB Sales Office.

kW	Speed	Frame	Inertia
15	1150/2000	2510AT	3.8
25	1150/2000	2811AT	7.6
30	1150/2000	2810AT	6.8
40	1150/2000	2810AT	6.8
60	1750/2100	2810AT	6.8
100	1150/2000	407AT	35.5
125	1150/2000	3612AT	31.6
200	1150/1800	506AT	98.7
250	1150/1700	506AT	98.7
300	1150/1600	508AT	121.8
400	1150/1500	5010AT	156
400	1750/2400	508AT	121.8
500	1750/2400	5010AT	156

DC Generators

120 Volts

Features

- Drip proof fully guarded enclosures
- Fields separately excited
- Locked bearing on commutator end
- 1.15 Service factor
- Shunt wound
- Class F temperatures rise
- 40°C ambient
- Other voltages to 600 VDC available



kW	RPM	Frame	Mult. Sym.	kW	RPM	Frame	Mult. Sym.
3/4	1750	L182AT	N1	13	1750	288AT	N2
	1450	L182AT	N1		1450	288AT	N2
	1150	L186AT	N1		1150	328AT	N2
	850	L186AT	N1		850	328AT	N2
1	3450	L182AT	N1	17	1750	288AT	N2
	1750	L182AT	N1		1450	328AT	N2
	1450	L186AT	N1		1150	328AT	N2
	1150	L186AT	N1		850	329AT	N2
	850	L186AT	N1		1750	328AT	N2
1.5	3450	L182AT	N1	21	1450	328AT	N2
	1750	L186AT	N1		1150	365AT	N2
	1450	L186AT	N1		850	366AT	N2
	1150	L186AT	N1		1750	328AT	N2
	850	218AT	N1		1450	328AT	N2
2	3450	L182AT	N1	25	1150	366AT	N2
	1750	L186AT	N1		850	368AT	N2
	1450	L186AT	N1		1750	366AT	N2
	1150	218AT	N1		1450	366AT	N2
	850	219AT	N1		1150	366AT	N2
3	3450	L186AT	N1	33	850	368AT	N2
	1750	L186AT	N1		1750	366AT	N2
	1450	218AT	N1		1450	366AT	N2
	1150	219AT	N1		1150	366AT	N2
	850	2110AT	N1		850	409AT	N2
4.5	3450	L186AT	N1	40	1750	366AT	N2
	1750	L186AT	N1		1450	366AT	N2
	1450	218AT	N1		1150	366AT	N2
	1150	219AT	N1		850	409AT	N2
	850	2110AT	N1		1750	L407AT	N2
6.5	1750	218AT	N1	50	1450	L407AT	N2
	1450	219AT	N1		1150	L407AT	N2
	1150	2110AT	N1		850	L409AT	N2
	850	259AT	N1		1750	L407AT	N2
	1750	219AT	N2		1450	L407AT	N2
9	1450	2110AT	N2	65	1150	L409AT	N2
	1150	259AT	N2		850	504AT	N2
	850	288AT	N2		1750	L407AT	N2
	1750	258AT	N2		1450	L407AT	N2
	1450	259AT	N2		1150	L409AT	N2
9	1150	288AT	N2	65	850	504AT	N2
	850	328AT	N2				

Note: Refer to Modifications Section for available options

DC Generators

250 Volts

Features

- Drip proof fully guarded enclosures
- Fields separately excited
- Locked bearing on commutator end
- 1.15 Service factor
- Shunt wound
- Class F temperatures rise
- 40°C ambient
- Other voltages to
- 600 VDC available



kW	RPM	Frame	Mult. Sym.	kW	RPM	Frame	Mult. Sym.	
3/4	1750	L182AT	N1	21	3450	259AT	N2	
	1450	L182AT	N1		1750	328AT	N2	
	1150	L186AT	N1		1450	328AT	N2	
	850	L186AT	N1		1150	365AT	N2	
1	3450	L182AT	N1		850	366AT	N2	
	1750	L182AT	N1		25	3450	288AT	N2
	1450	L186AT	N1			1750	328AT	N2
	1150	L186AT	N1			1450	328AT	N2
	850	L186AT	N1	1150		366AT	N2	
3450	L182AT	N1	850	368AT		N2		
1.5	1750	L186AT	N1	33	3450	288AT	N2	
	1450	L186AT	N1		1750	328AT	N2	
	1150	L186AT	N1		1450	366AT	N2	
	850	218AT	N1		1150	366AT	N2	
	3450	L182AT	N1		850	368AT	N2	
2	1750	L186AT	N1	40	3450	328AT	N2	
	1450	L186AT	N1		1750	366AT	N2	
	1150	218AT	N1		1450	366AT	N2	
	850	219AT	N1		1150	368AT	N2	
	3450	L186AT	N1		850	409AT	N2	
3	1750	L186AT	N1	50	3450	329AT	N2	
	1450	218AT	N1		1750	368AT	N2	
	1150	219AT	N1		1450	368AT	N2	
	850	2110AT	N1		1150	407AT	N2	
	3450	L186AT	N1		850	409AT	N2	
4.5	1750	218AT	N1	65	1750	368AT	N2	
	1450	219AT	N1		1450	407AT	N2	
	1150	2110AT	N1		1150	L409AT	N2	
	850	259AT	N1		850	504AT	N2	
	3450	218AT	N2		85	1750	L407AT	N2
1750	219AT	N2	1450	L407AT		N2		
1450	2110AT	N2	1150	504AT		N2		
1150	259AT	N2	850	506AT		N2		
850	288AT	N2	100	1750		L409AT	N2	
3450	218AT	N2		1450	504AT	N2		
1750	258AT	N2		1150	506AT	N2		
1450	259AT	N2		850	506AT	N2		
1150	288AT	N2		125	1750	L409AT	N2	
8500	328AT	N2	1450		504AT	N2		
3450	219AT	N2	1150		506AT	N2		
1750	259AT	N2	850		508AT	N2		
1450	288AT	N2	170		1750	506AT	N2	
1150	328AT	N2		1450	506AT	N2		
850	328AT	N2		200	1750	506AT	N2	
3450	258AT	N2			1750	506AT	N2	
1750	288AT	N2			1750	506AT	N2	
1450	328AT	N2	1450		506AT	N2		
1150	328AT	N2	850		365AT	N2		
850	365AT	N2						

Note: Refer to Modifications Section for available options

Lifting Magnet Generators

Features

- Drip proof fully guarded enclosure
- 230 VDC output
- Class h insulation - class F rise
- Double sealed ball bearings
- 2 Pole, compound wound with drooping voltage characteristics
- Weather resistant epoxy paint
- F-2 conduit box location (except 180 frame)
- Available from stock

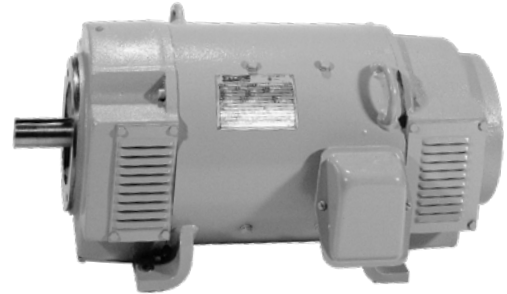

kW	Base Speed	NEMA Frame	Voltage Direct Current		Full Load Amperage		Catalog Number	Mult. Sym.	Field Control Rheostat	
			Armature	Field	Armature	Field			(Ohms)	Amps Max
5	2500	1810AT	230	230	21.7	0.61	DMG2305	N2	300	0.85
7 1/2	2500	219AT	230	230	32.6	1.14	DMG2307	N2	150	1.6
10	2500	219AT	230	230	43.5	0.72	DMG2310	N2	200	1.4
10	2500	219ATC	230	230	43.5	0.72	CDMG2310	N2	200	1.4
15	1750	259AT	230	230	65	1.3	DMG2315	N2	200	1.82
15	1750	259ATC	230	230	65	1.3	CDMG2315	N2	200	1.82
20	1750	288AT	230	230	87	1.8	DMG2320	N2	125	2.52
20	1750	288ATC	230	230	87	1.8	CDMG2320	N2	125	2.52
25	1750	328AT	230	230	109	2.13	DMG2325	N2	100	3.0
25	1750	328ATC	230	230	109	2.13	CDMG2325	N2	100	3.0
33	1750	328AT	230	230	144	2.13	DMG2333	N2	100	3.0
33	1750	328ATC	230	230	144	2.13	CDMG2333	N2	100	3.0
40	1750	329AT	230	230	174	3.7	DMG2340	N2	50	5.2

Note: Field control rheostat and meters are not included in price or available from ABB.

Round Frame Modifications and Accessories

Modifications which can be manufactured as part of a custom motor design.

Common Modifications

Modification Number	Mechanical Modifications
1.0-1 .1	Altitude
2.0-2.1 Ambient	Temperature
3.0-3.2	Balance
4.0	Bases - Sliding
4.1	Base - Adapter Rails
4.2	Base - Soleplate
4.5	Bearing Insulated
5.0-5.2	Belted Loads
5.3	Belted Drives
6.0	Brakes - AC Coil
6.1	Brakes - DC Coil
6.2	Brakes - Vertical - Standard
6.3	Brakes - Dust Tight - Waterproof
6.4	Brakes - Accessory Face
6.5	Brakes - Space Heater
6.6	Brake Mounting Provisions
7.1	Brush - Low Current Density
7.2	Brush - PVC Environment
8.0-8.3	Conduit Boxes
9.0	Coupling or Brake Wheel Mounting
10.0	Covers - DPFG
10.1	Covers - SPFG
10.2	Covers - Transparent
11.0	Enclosure - DPBV - Less Filter
11.1-11.2	Enclosure - DPBV - With Filter
11.3	Enclosure - DPSV
11.4	Enclosure - TEPV
11.5	Enclosure - TEAO
11.6	Enclosure - Weather Proof
11.7	Enclosure - Dust-Proof
11.8	Enclosure - Dirty Duty
11.9	Transit Duty
12.0	Drain Holes - with Plugs
12.1	Automatic Breather Drain
14.0	End Brackets - C Face
14.1	End Brackets - D Flange
14.2	End Brackets - P Base
15.0	Feet - Special NEMA ATY
15.1	Footless Frame
16.0-16.2	Field Voltage - Special
16.3	Fields - Shunt Wound
16.4	Fields - Stabilized Shunt Wound
16.5	Fields - Compound
16.6	Fields - Series
17.0	Grease - Standard
17.1	Grease - Special Cold Ambient
17.2	Grease Fittings with Reliefs
18.0	Insulation Class "F"

Modification Number	Mechanical Modifications
18.1	Insulation Class "H"
18.2	Insulation VPI
19.0	Leads - Extra Length
19.1	Leads - Lugs
20.0	Marine Motors and Generators
21.1-21.4	Paint
22.0	Differential Pressure Switch
22.5	Packaging - Standard
22.6	Packaging - Open Slat
22.7	Packaging - Enclosed Crate
23.0	Service Factor
24.0	Shaft Extension Commutator End
24.1	Special Shaft - Dimensions
24.2	Special Shaft - Configuration
24.3	Special Shaft- Runout Tolerance
24.4	Shaft Guard
24.5-24.6	Special Shaft Material
25.0-25.4	Shaft Seals
26.0-26.1	Space Heaters
27.0	Speed Limit Switch
27.1	Shaft Grounding Brush
28.0	Speed Range - Extended
29.0	Speed Limitations
30.0-30.1	Speed - Special Base
30.2	Speed - Base Speed 3500 RPM
31.0-31.12	Tachometers
32.0-32.3	Tach Adapter
33.0	Tach Supplied by Customer
33.1	Tach & Adapter Supplied by Customer
34.0	Dimensions, Connections, Electrical Data and Maintenance
35.0-35.3	Tests - Certified and Witnessed
36.0	Tropical Protection
37.0	Terminal Board Connections
38.0	Thermostat on Interpole Coil
38.1	Thermostat on Field Coil
38.2-38.3	Warning Thermostats
39.0	Thermistors - Interpole Coil
39.1	Thermistors - Field Coil
39.2-39.4	Warning Thermistors
40.0-40.1	Resistance Temperature Detectors
41.0	Vertical Mount - Drip Proof
41.1	Vertical Mounting Drip Cover
41.2	Vertical Lifting Provisions
42.0	Voltage - Special Armature
43.0	Warranty - Three Year Mod Express Section

Round Frame Modifications and Accessories

No.	Modification	Description
1.0	Altitude-Standard	Standard ratings are based upon the motors or generators operating at altitude from sea level to 3300 feet per NEMA MG1-14.04.
1.1	Altitude-Special	For motors or generators operating over 3300 feet, refer to the derating chart in the CA608D. Select the appropriate motor frame and rating based on this chart. Use this higher HP motor frame and list price.
2.0	Ambient-Temperature Standard	Standard ratings are based upon the motors or generators operating in ambient up to 40°C.
2.1	Ambient-Temperature Special	For motors or generators operating over 40°C, refer to the derating chart in the CA608D. Select the appropriate motor frame and rating based on this chart. Use this higher HP frame and list price.
3.0	Balance-Standard	Meets the dynamic balance limits of the NEMA Standard MG1-12.05 for maximum amplitude (peak-to-peak displacement) in inches at the highest rated speed. Does not apply to brakes, tachometer generators, sheaves, etc.
NOTE: The ripple currents associated with rectified power supplies produce high frequency forces that may cause vibration similar to that of mechanical unbalance.		
3.1	Ultra Standard	For applications which require a higher degree of balance. Other specs per above option 3.0.
3.2	Balance-Precision	For applications requiring our highest degree of balance. Other specs per above option 3.0.
4.0	Bases-Sliding	Allows adjusting of motor position for belt tensioning or alignment. For horizontal mounting only. Two bolt adjustment-all frame sizes.
4.1	Base-Adapter Rails	Provides adapter rails to permit using a current design motor with its smaller "D" dimension. This provides rails only and is normally used for coupled applications only.
4.2	Base Soleplates	Provides two steel plates for customer installation between motor and foundation.
4.5	Bearing Insulated	For single insulated bearing 180AT-500AT frame.
5.0	Belted Loads, Standard Ball Bearings	Standard ball bearings are suitable for either direct drive or belted applications. Contact a local ABB Sales Office for assistance with load calculations. Refer to CA608D for Radial Load Data.
5.1	Belted Loads, Maximum Capacity Ball Bearings (Drive End)	Maximum capacity ball bearings are suitable for belted applications. Contact a local ABB Sales Office for assistance with load calculations. These bearings have a greater capacity for supporting heavier radial loads. Should not be used with thrust loading. Includes grease fittings and reliefs (except 180 frame).

Round Frame Modifications and Accessories

No.	Modification	Description
5.2	Belted Loads, Roller Bearing (Cylindrical Type-Drive End)	Roller bearings are suitable for high radial belted applications when used within the limits given in Application Section D or contact a local ABB Sales Office for assistance with load calculations. These roller bearings give high radial capacity. When roller bearings are required, includes grease fittings and reliefs (except 180 frame). Refer to CA608D for Radial Load Data.
5.3	Belted Drives, Over Length Roller Bearing (Drive End)	Over length cylindrical roller bearings are suitable for very high belted applications. Contact a local ABB Sales Office for assistance with load calculations. These roller bearings give very high radial capacity. When roller bearings are required, includes grease fittings and reliefs (except 180 frame).
6.0	Brakes, Disc Type, Motor Mounted, AC Coil	These brakes are continuously rated, non-adjustable, electrically released and spring set. Applicable for both holding and stopping if within the normal torque ratings. Applications which require frequent stops or other severe duties may exceed the thermal limits of the brake and should be referred to ABB. Pricing includes addition for commutator end shaft extension. Manual release is standard on 25 ft. lbs. and above. Designed to mount to standard accessory face. Contact a local ABB Sales Office for availability of brakes on TEFC motors. Standard brake coils: 115 VAC SINGLE PHASE 230 VAC SINGLE PHASE 460 VAC SINGLE PHASE SPECIFY ONE OF THE ABOVE AT TIME OF ORDER If a tachometer is required, add for option 6.5, Accessory Mounting Face.
6.5	Brakes, Space Heaters For Brake	Whenever a space heater is to be used in a motor, a heater should also be used in the brake. Does not include brake.
		Brake size 3-105 lb-ft 125-500 lb-ft
6.6	Brake Mounting Provision	Provides flange and motor shaft extension on opposite drive end for customer mounting of brake. Not available for TEFC enclosure.
7.1	Brush-Low Current Density	Special brush grade to allow motor to be operated below 50% of rated current and retain good commutation and brush life.
7.2	Brush PVC Environment	Special brush grade to allow motor to be operated in an environment where PVC is present.
8.0	Conduit Box Location - Standard	Baldor-reliance motors can be supplied with either F1 or F2 conduit box location. Unless otherwise specified the motor will be supplied with an F1 conduit box location. No standard external conduit box on 180 frame motors. Standard 180 frame conduit box is internal.
8.1	Conduit Box Location Top Mounted	Conduit box is mounted on the top of the motor. Standard location for this option is on the commutator end of the motor.
8.2	Conduit Box - Oversized	Conduit box is one size larger than standard.
8.3	Conduit Box - Cast Iron	Conduit box is of a cast construction versus the standard deep drawn steel construction.
9.0	Coupling Or Brake Wheel Mounting (Finished)	Mounting charge for coupling or brake wheel supplied by the customer with a finish bore and keyseat to factory dimensions.

Round Frame Modifications and Accessories

No.	Modification	Description
10.0	Covers-DPFG (Standard)	These covers are designed for horizontal DPFG motors which permits the free exchange of air between the inside and outside of the motor but prevents liquid or solid particles from entering the motor at angles less than 15 degrees from vertical.
10.1	Covers-SPFG (Splash Proof Fully Guarded)	These covers are designed for horizontal SPFG motors which permits the free exchange of air between the inside and outside of the motor but prevents liquid or solid particles from entering the motor at angles less than 100 degrees from vertical.
10.2	Cover - Transparent	One solid transparent Lexan® cover replaces a solid or louvered cover. This cover allows visual inspection of the brushes and other internal components in the commutator end. When more than one cover is required, multiply the number required times this option.
Enclosures		
11.0	Enclosure - Drip Proof Blower Vent (DPBV) - Less Filter	For use on drip proof fully guarded motors. See speed-torque curves in the application section. Blowers can not be mounted on the same side as the conduit box unless a special stand-off adapter is purchased 1Ø Blower 3Ø Blower 3Ø LM9 Blower
11.1	Enclosure- Drip Proof Blower Vent (DPBV)-With Filter	Same as 11.0, with filter. 1Ø Blower 3Ø Blower 3Ø LM9 Blower
11.2	Enclosure- Drip Proof Blower Vent (DPBV)-With Filter, High Capacity For Extruders	Higher flow blower for extruder duty with ambient to 65°C, includes higher flow blower, low restriction louvers, washable filter, differential pressure switch (For detection of a failed blower motor - will not monitor filter conditions). PVC brushes (if required). 3Ø Blower
11.3	Enclosure- Drip Proof Separately Vented (DPSV)	For applications where contaminated atmospheres are present and/or constant torque is required below base speeds (see speed torque curves). A flat surface with drilled and tapped bolt holes (except for the 180AT frames) are provided for attachment of inlet air piping. Specify at time of order the location of air inlet (3, 6, 9 or 12 o'clock facing commutator end).
11.4	Enclosure- Totally Enclosed Pipe Vented (TEPV)	Same as above option (11.3) except air is piped in and out.
11.5	Enclosure- Totally Enclosed Air Over (TEAO)	This design consists of a motor mounted AC blower attached to a sheet metal shroud which is mounted on the top of the motor frame. The output air is directed over the frame of the motor, allowing higher torques at lower speeds. Should be considered when noise levels become excessive and/or when brakes with tachometers need to be added to TEFC motors. Add to base price of TEFC motor (except 500 frame).
11.6	Enclosure- Weather Proof- Outdoor Duty	This modification allows a TENV, TEPV, TEFC or TEAO motor to operate where the motor is exposed to weather. Do not use TEFC or TEAO motors in outdoor applications where ice could form on the external fan blades. Outdoor motors must have either space heaters or their fields energized at 50% of rated voltage at stand still to guard against condensation forming inside the motor. Includes: Epoxy Paint on motors and all accessories Epoxy Primer on Armature, Shaft and inside Endplates Double sealed Ball Bearings Corrosion resistant hardware Gasketed covers & Conduit Box Threaded inlet on Conduit Box Sealed Endplate joints & External Bolts Shaft Slinger Drain Holes
11.7	Enclosure- Dust-Proof/ Taconite Features	For totally enclosed machines which require protection against fine abrasive dust (ie.-taconite). Design incorporates special sealant on all fits, special gaskets, fittings with reliefs and a labyrinth seal on the drive end. This option applies only to TENV, TEFC and TEPV motors.

Round Frame Modifications and Accessories

No.	Modification	Description
11.8	Enclosure-Dirty Duty	The Baldor-Reliance Dirty Duty motor is similar to construction for AC motors and designed for operation in damp locations and corrosive environments. Dirty Duty motors are available only on TENV, TEFC, TEAO, TEPV and TEUC enclosures. The TEUC motor has exposed aluminum heat exchanger tubes. If a severe corrosive is present, this aluminum heat exchanger should be replaced with one made of stainless steel. (1) Dirty Duty motors must have either space heaters or their fields energized at 50% of rated voltage at standstill to guard against condensation forming inside the motor. Includes: Epoxy Paint on motor and all accessories Epoxy Primer on Armature, Shaft and inside Endplates Greases and Reliefs Epoxy coating on external aluminum parts Corrosion resistant hardware Gasketed covers & Conduit Box Threaded inlet on Conduit Box Sealed Endplate joints & External Bolts Shaft Slinger b) Same as above except with stainless steel shaft.
11.9	Transit Duty	Contact a local ABB Sales Office for application assistance.
12.0	Drain Holes	Drain holes are located at the lowest point of the motor to drain condensation.
12.1	Automatic Breather Drain Stainless Steel	A self-acting drain to allow condensation collected at the lowest point of the motor to exit.
14.0	End Brackets-NEMA C-Face	See dimensional drawings. When oil is present it is recommended that a shaft seal is added to this option (See shaft seal option 25.0, 25.1, 25.3 or 25.3).500 frame endplate is fabricated - allow extra lead time.
14.1	End Brackets-NEMA D-Flange	See dimensional drawings. When oil is present it is recommended that a shaft seal is added to this option (See shaft seal option 25.0 or 25.1)
14.2	End Brackets NEMA P-Base	Since there is not a NEMA standard for DC P-Base motors, customer dimensions must be supplied to ABB with the order. An adapter will be added to our D-Flange to give the desired P-Base mounting. Also add for special shaft, footless frame and vertical mounting if required. Consider Dirty Duty features.
15.0	Feet-Special NEMA Aty	When the foot dimensions are required to be longer or shorter for the 2F dimension - use this adder.
15.1	Footless Frame	The feet are removed from the frame; however, a C-Face or a D-Flange must be added to this option.
16.0	Field Voltage-Standard	The standard field voltages are as follows: For 180v arm - 100/200; for 240 or 500v armature - 120/240 or 150/300
16.1	Field Voltage-Special (37.5-360 Volts)	The standard field voltages between 37.5 - 500 use the following adders:
16.2	Fields-Shunt Wound	Stock motors in Frames 180AT - 500AT are wound as straight shunt.
16.3	Fields-Stabilized Shunt Wound	Frames 360AT - 500AT were wound as stabilized shunt until 3rd Quarter 2006. On regenerative drives, it is necessary to wind the motor as a straight shunt; otherwise, the series winding would oppose the shunt winding when the motor is reversed or during regeneration. There is no additional charge for shunt wound option; however, it is necessary to inform order entry that the application is regenerative.

Round Frame Modifications and Accessories

No.	Modification	Description
16.4	Fields-Compound	Standard compound wound motors will have a speed regulation of approximately 15-25%. Compound wound motors are not usually suited to applications requiring speed control by field weakening. The maximum field weakening that a compound motor will accept is 125% with the approval of ABB's engineering department.
16.5	Fields-Series	WARNING: Series wound motors must be connected to a positive load which is never less than 25% of the rated load otherwise destructive high speeds will occur.
17.0	Grease-Standard	The standard grease is Exxon Polyrex EM which is rated for an operating temperature range of a -29°C to +177°C.
17.1	Grease-Special Cold Ambient	Ambient temperatures below -30°C Aeroshell #7 grease would be used which has an operating range of -100°F to +250°F. It is recommended that a space heater or a field economy circuit be used in cold environments to prevent condensation inside the motor. It is also recommended that a field current regulator be installed in the control, because without it, the motor will never reach its rated speed. Brush grade may also need to be changed.
17.2	Grease Fittings With Reliefs	This option allows the bearing to be purged of any contaminant and allows the proper amount of grease to be maintained in the grease cavity. *Note: On all 180AT frames, a C face or a D flange must be added to provide for grease pathway – add for fittings and optional (required) face or flange.
18.0	Insulation Class "F"	Our standard motors incorporate Class H insulation as standard with the exception of the lead wires.
18.1	Insulation Class "H"	Total insulation system is of a Class H design, motor is Class F temperature rise for longer insulation life.
18.2	Insulation VPI	VPI insulation system provided on armature and stationary coils. Standard on 360AT-500AT frames.
19.0	Leads-Extra Length	This option is per foot length and is provided without a terminal box or lead terminals.
19.1	Leads, Burndy Lugs	Crimp type lead lugs provided as standard for armature and any series field leads. For Burndy crimp type lead lugs.
20.0	Marine Motors & Generators-Below Deck	These motors are designed to meet IEEE 45 Marine Standards, American Bureau of Shipping, U.S. Coast Guard Marine Service for below deck service only.
21.0	Paint-Customer Supplied	Customer supplied paint must be compatible with the standard factory installed air dry primer, otherwise additional charges will be added. Material Safety Data Sheet per OSHA must accompany the paint.
21.1	Paint- Factory Supplied	Special color or type of paint will be furnished as long as the paint is compatible with our standard air dry primer.
21.2	Two-Coat Epoxy	2 coat epoxy/Omega Plus is a paint system that provides protection for moderate chemical environments and UV exposure, ISO C-3.
21.3	Extreme Paint System	Extreme duty paint system for marine duty/offshore or highly corrosive atmospheres, requires a sand blast surface preparation, ISO C-5.
21.4	Custom	Custom paint system requires customer to supply specification for sales/ engineering review.
22.0	Differential Press. Switch (Air Flow)	This device is pressure sensitive and is mounted to the output side of the blower housing. Includes its own NEMA 4 conduit box (IP55). May be used to detect a blower motor failure, will not monitor filter conditions.
22.5	Packaging Standard Or Euro Pallet	Standard packaging.

Round Frame Modifications and Accessories

No.	Modification	Description
22.6	Packaging Open Crate	Provides additional protection for air and land shipment.
22.7	Packaging Enclosed Crate	Provides enhanced protection and required for ocean shipment. Does not provide for any overseas fees, documentation, etc.
23.0	Service Factor	All of the motors listed in the pricing section carry a 1.0 service factor. When there is a requirement for a higher service factor multiply the HP required by the appropriate service factor (ie; 10 HP times 1.15 = 11.5 HP), since this is not a cataloged motor the next higher horsepower motor would be used which has the same RPM's and enclosure for the list price. If the calculation equals a catalog motor with the same enclosure and RPM's then that list price would be used.
24.0	Shaft Extension Commutator End	The standard double shaft extensions are shown in the dimensional drawings.
24.1	Special Shaft- Dimensions	A) For shaft length shorter than standard dimensions. B) For shaft length longer than standard dimensions. C) For shaft diameter smaller than standard dimensions. D) For shaft diameter larger than standard dimensions. See Chart on page 37 for dimensions.
24.2	Special Shaft- Configuration	A) Splined shaft per customers drawing. B) Tapered type shaft per customers drawing. C) Tapered NEMA AC shaft (Tapered 1.25" or 1.50" per foot) D) Shaft threads - Class 2A right hand thread.
24.3	Special Shaft- Runout Tolerance	A) Standard shaft runouts (at the tip of the motor shaft for std. shaft lengths) per NEMA STANDARDS: 180AT - 250AT -----0.002" 280AT - 500AT -----0.003" B) Special shaft runouts (at the tip of the motor shaft for std. shaft lengths): 180AT - 250AT -----0.0010" 280AT - 500AT -----0.0015" See Chart on page 37 for Special Shaft tolerances.
24.4	Shaft Guard	Provides protective cover over opposite drive end (commutator end) shaft extension. WARNING: To prevent injury, shaft guard must be specified or supplied by customer for exposed shaft extensions.
24.5	Special Shaft Material Aisi 4150	Standard shaft material is AISI 1045. Add for AISI 4140/4150 material.
24.6	Special Shaft Material 316 Stainless	Standard shaft material is AISI 1045 for 180 thru 500. Add for 316 stainless.

* Contact sales.

Round Frame Modifications and Accessories

Shaft Diameter length and Runout Availability

Frame	Min. Shaft diameter.	Std. Shaft diameter.	Max. Shaft diameter ¹	Max. Shaft length, runout
180	.625	1.125	1.125	'V' = 4.50", .003" When 'v' is longer than 4.50" Contact ABB
210	.875	1.375	1.375	'V' = 4.50", .003" When 'v' is longer than 4.50" Contact ABB
250	1.125	1.625	1.625	'V' = 5.00", .003" When 'v' is longer than 5.00" Contact ABB
280	1.375	1.875	1.875	'V' = 5.50", .005" When 'v' is longer than 5.50" Contact ABB
320	1.625	2.125	2.125	'V' = 6.00", .005" When 'v' is longer than 6.00" Contact ABB
360	1.875	2.375	2.375	'V' = 6.50", .005" When 'v' is longer than 6.50" Contact ABB
400	2.125	2.625	2.625	'V' = 7.00", .005" When 'v' is longer than 7.00" Contact ABB
500	2.750	3.250	3.250	'V' = 8.32", .005" When 'v' is longer than 8.32" Contact ABB

Note: 1. Larger Shaft diameters may be available with oversize bearings and special fabricated endplates. Contact a local ABB Sales Office for feasibility and adder.
 2. 2.375 Diameter. with special shaft end bracket – Contact a local ABB Sales Office for adder.

No.	Modification	Description
25.0	Shaft-Lip Seal (For Splashing Conditions)	This modification protects either bearing from oil splashing into the bearing cavity. Without this option the oil would cause premature bearing failure. Seals when operated dry for long periods will be damaged. Add per seal.
25.1	Shaft-Face Seal (For Head Pressures)	This modification protects the drive end bearing when there is a head pressure of oil against the shaft (ie: gear box connected directly to the motor). Seals when operated dry for long periods will be damaged.
25.2	Shaft Seal Inpro®	This option provides an Inpro/Seal® on either bearing of the motor. It protects against liquids, solids, steam and slurry. Add per seal.
25.3	Shaft Face Seal-Forsheda®	This modification helps protect either bearing from oil and dust contamination. Add per seal.
25.4	Dustproof/Taconite	Provides non-magnetic labyrinth seals on all exposed shafts. This modification is intended for totally enclosed machines only for protection against fine abrasive dust such as taconite.
26.0	Space Heaters-In Motors	This option prevents condensation from occurring when the motor is not energized. When the control has a field economy circuit, this option is not necessary as long as the field economy is energized. Must specify the A.C. input at the time of the order (120, 230 or 460 volts - single phase - 50/60 Hz.)
26.1	Space Heaters-Additional Conduit Box	This option allows for an additional conduit box (For the space heater leads) mounted on the opposite side of the motor conduit box.
27.0	Speed Limit Switch	This device is an Electro-Sensors LRB-1000 having a single relay output with 1-100 and 10-1000 RPM set point ranges. If required, double set point model available at extra cost.
27.1	Shaft Grounding Brush	A shaft grounding brush is mounted externally on the drive end of the motor. It eliminates possible bearing failures caused by shaft voltages. It includes a labyrinth seal.

Round Frame Modifications and Accessories

No.	Modification	Description
30.0	Speed-Special Base (Standard)	Special base speed motors can be obtained by selecting a motor with the next lower base speed and then field weakening the motor by the means of a fixed field resistor. This method is allowable up to the top rated speed of the motor (See electrical specifications)
30.1	Speed-Special Base (Special)	If the above method is unacceptable, ABB can usually design a special base speed motor to the customer's requirements by taking the next lower base speed and adding:
30.2	Speed-Base Speed 3500 RPM	For 3500 RPM base speed designs listed on the basic rating pages, make the following adder to the basic list price:
TACHS NO. 31.0 THROUGH 31.12 INCLUDE TACHOMETER, ADAPTER AND COUPLING.		
31.0	Tachometers-DC (XPY) *	Baldor-Reliance XPY DC tachs mounted to commutator end of motor. For electrical, mechanical, and maximum speed specifications, see tach brochure. 50 and 100 VDC/1000RPM
31.1	Tachometers-Digital (Encoder) *	A BEI H25 encoder with a PY style shaft and flange mounted to the commutator end of the motor. 500, 1000 or 1024 PPR, dual channel, index marker with complements, and line driver. Contact a local ABB Sales Office for price and availability of special line counts. Uses same encoder cables as AC vector motors.
31.2	Tachometers-Digital (Encoder Electrically Isolated) *	A BEI H25 encoder with a special flange mounted to the commutator end of the motor. 500, 1000 or 1024 PPR, dual channel, index marker with complements, and line driver. Contact a local ABB Sales Office for price and availability of special line counts. Uses same encoder cables as AC vector motors.
31.3	Tachometers-Piggyback Back Mount	Allows one of the above tachometers to be coupled to the motor by means of a timing belt. Use this adder in addition to the flange mounted prices above.

Round Frame Modifications and Accessories

Avtron Avtron encoders should be mounted to the ODE of the motor. All are bi-directional with complementary outputs.	HS45 (Replaces M3) Hollow-shaft magneto-resistive encoder with 3 ft. flexible cable-sealed. 5-24 volt line driver. 60-5000 ppr. IP65 enclosure.	Replaces M3 optical encoder. 0.625" to 1.125" shaft bore	Single output
			Dual output
	M4 Hollow-shaft magneto-resistive encoder, with 3 ft. flexible cable – sealed. 5-24 volt line driver. 512, 1024 or 1200 PPR 1.5" to 2.375" shaft bore.		Single output
			Dual output
			Shaft grounding to above unit
	AV850 SMARTachII™ (replaces M285) magneto-resistive bearingless pancake tach with 8.5" double C-face. 8 to 5000 PPR		Single output
			Dual output
	AV485 SMARTachII™ (replaces M485) Washdown duty IP66 rating magneto-resistive encoder with NEMA 56C face. Stainless steel shaft, sealed bearings and shaft seals. 8 to 5000 PPR		Single output
			Dual output
			Shaft grounding to above unit
	AV685 SMARTachII™ (Replaces M685) Heavy mill duty magneto-resistive hollow shaft encoder. 8 to 5000 PPR		Single output
			Dual output
		Shaft grounding to above unit	
AV85 ThinLinell™ (Replaces M85) Magneto-resistive bearingless tach with 8.5" double C-face. 8 to 5000 PPR		Single output	
		Dual output	
	HS35M Magnetic hollow-shaft non-metallic housing up to 3072 PPR		
No.	Modification		Description
31.12 (Cont.)	Tachometer – Digital Pancake	Various pulse generators are available from outside suppliers. These are usually mounted to the accessory flange on the commutator end of the motor. Many are double C-face allowing through shaft use for brakes or other accessories mounted to them. Contact a local ABB Sales Office for details on a particular pulse generator, included hardware, and availability.	
NorthStar			RIM™ Tach HS85, hollow shaft
NorthStar Division of Dynapar Controls pulse generators should be mounted to the ODE of the motor. These use a magneto-resistive technology. All are bi-directional with complementary outputs, 5-26 VDC power, line driver output.			60 thru 600 PPR, single output
			60 thru 600 PPR, dual output
			960, 1024 or 1200 PPR, single output
			960, 1024 or 1200 PPR, dual output
			2048 PPR, single output
			2048 PPR, dual output
			SLIM™ Tach ST85 bearingless. Not double C-face
			64 thru 2048 PPR, single output
			64 thru 2048 PPR, dual output
			SLIM™ Tach ST85 bearingless, double C-face "Sandwich" mounting
			64 thru 2048 PPR, single output
			64 thru 2048 PPR, dual output
			RIM™ Tach 8500 bearingless, double C-face with single or dual outputs.
			64 thru 600 PPR, single output
			64 thru 600 PPR, dual output
			960, 1024 or 1200 PPR, single output
			960, 1024 or 1200 PPR, dual output
			2048 PPR, single output. Max shaft diameter 2.875".
			2048 PPR, dual output. Max shaft diameter 2.875".

Round Frame Modifications and Accessories

No.	Modification	Description
32.0	Tach Adapters- PY Style *	Tach kit allows mounting of a PY flange tach or encoder to accessory face of a Baldor-Reliance motor. Includes aluminum adapter housing, stub shaft, coupling, and mounting hardware
32.1	Tach Adapters- Heavy Duty PY Style *	Tach kit allows mounting of a PY flange tach or encoder to accessory face of a Baldor-Reliance motor. Includes cast iron adapter housing, stub shaft, coupling, and mounting hardware.
32.2	Tach Adapters- Heavy Duty XC42 & XC46 * (56C) Style	Tach kit allows mounting of a 56C face tach or encoder to accessory face of a Baldor-Reliance motor. Includes cast iron adapter housing, stub shaft, coupling, and mounting hardware.
32.3	Tach Adapters- For Enc00nv Encoder Kit *	Kit allows mounting of a Baldor-Reliance Enc00nv isolated encoder to the accessory face of the DC motor.
33.0	Dimensions, Connections, Electrical Data & Maintenance	ABB will supply up to five sets of dimensions, connection diagrams, electrical data & maintenance manuals at no additional charge if requested at the time of order entry.
34.0	Certified Copies Of Test	Standard NEMA test are performed on all motors; however, when certified test are required, live sets of reports will be sent.
34.1	Witnessed Routine Test	When routine NEMA test are to be witnessed, the customer will be notified two days before the motor is ready for test.
34.2	Performance & Heat Run Testing	This option provides for testing of the motor on a dynamometer with motor horsepower, speed torque and efficiency recorded as a function of armature current up to 150%. The standard motor is rated at 150% current for one minute. Six sets of results will be provided
34.3	Performance & Heat Run Test- Witnessed	Same as above except witnessed. The customer will be notified two days before the motor is ready for test. Six sets of results will be provided.
35.0	Tropical Protection	The standard insulation system provides for protection against high humidity and fungus as found in tropical climates. If the motor will be stored for prolonged periods, additional protection can be provided by the means of a special fungicidal air dry varnish applied over all of the motor windings.
36.0	Terminal Board Connections	Terminal board in conduit box for armature shunt field and stabilized shunt field connections. Includes auxiliary terminal strip for thermostat and accessory leads. Also consider enclosure; Dirty Duty and space heater options.
37.0	Thermostat On Interpole Coil	This device is mounted on the interpole coil, which provides a reasonably accurate method for approximating the armature temperature. On separately-vented motors, the thermostat protection is drastically decreased at low speeds. The differences between armature and interpole coils occurs at low speeds because the interpole coil has the same heat transfer regardless of the speed which is not the case for the armature (As the speed is reduced so is the armature turbulence, this causing higher temperatures). Also the interpole coil has as much as five times the thermal time constant compared to the armature. Because of the longer time constant the thermostat can not be relied upon to protect the armature during extreme overloads for short durations. The accuracy of this device is affected by the ripple content of the power supply and by the inherent tolerances of mounting. Normally closed contacts.
37.1	Thermostat On Field Coil	Same device as above except it is mounted on the field coil. This option is recommended when a field regulator is used on the control. Normally closed contacts.
37.2	Warning Thermostat On Interpole Coil	This device is set at 15°C lower than the high limit thermostat. Normally closed contacts.
37.3	Warning Thermostat On Field Coil	This device is set at 15°C lower than the high limit thermostat. Normally closed contacts.
38.0	Thermistors Interpole Coil	Two of these high limit devices are mounted on the interpole coil with four leads brought into the standard conduit box. This device offers the same functional protection as a thermostat, but with a higher degree of accuracy. A separate electronic control module is required in conjunction with this device.
38.1	Thermistors- Field Coil	Same as above except mounted on the field coils. (Qty 2)

Round Frame Modifications and Accessories

No.	Modification	Description
39.2	Warning Thermistors-Interpole Coil	This device is set at 15°C lower than the high limit thermistors. (Qty 2)
39.3	Warning Thermistors-Field Coil	This device is set at 15°C lower than the high limit thermistors. (Qty 2)
39.4	Control Module For Use With Thermistors	Baldor-Reliance P/N 418033-14B (S/N 115101-2) supplied in a NEMA 12 enclosure for separate mounting. Requires 120 volt, 60/50Hz single phase 5 ampere unit. Provides two triac outputs - one normally energized and one normally off - each rated 5 amperes continuous. Add for unmounted control module, 1,508 list.
40.0	Resistance Temperature Detector (RTD) Interpole Coil	This option has an RTD mounted on the interpole coil or field pole coil which requires customer supplied instrumentation. An analog signal is produced which measures the temperature of the interpole coil. The measurement restrictions of this device are the same as described for a thermostat. 10 Ω Copper 100 Ω Platinum (Most Common) 120 Ω Nickel
40.1	Resistance Temperature Detector (RTD) Bearing	This option provides for the mounting of an RTD in the bearing cavity to sense temperature of the bearing. Price is per bearing. 10 Ω Copper 100 Ω Platinum (Most Common) 120 Ω Nickel
41.0	Vertical Mount Drip-Proof Construction	Frame sizes 180AT-400AT can be operated in the vertical position as long as there is no external thrust load applied to the armature shaft, however, special louvers will have to be only for drip-proof designs. For 500AT frames refer to a local ABB Sales Office.
41.1	Vertical Mount Drip Cover	Frame sizes 180AT - 400AT can be operated in the vertical position as long as there is no external thrust load applied to the armature shaft. Drip cover for standard TEFC motors for extra protection from dripping liquids and falling objects when motor is mounted in vertical shaft down position. Not available when accessories (brakes, feedback devices etc.) are mounted on ODE. For 500AT frames, refer to a local ABB Sales Office.
41.2	Vertical Lifting Provision	Frame sizes 180AT - 400AT can be operated in the vertical position as long as there is no external thrust load applied to the armature shaft. For 500AT frames, refer to a local ABB Sales Office. Provides provision for vertical lifting.
42.0	Voltage-Special Armature	Standard voltages listed below are produced at no charge 180AT - 328AT FRAME - 180V, 240V & 500V 360AT - 500AT FRAME - 240V, 500V Note: 600V max. Not suitable for 3rd rail transit duty with above 600 volt peaks. For other voltages between 180 and 600 volts. ⁽¹⁾ For 120 or 125 volts on motor ratings up to 40 Hp. ⁽¹⁾ For other voltages: CONTACT FACTORY
43.0	Warranty-36 Month Extended Gold Seal	The Baldor-Reliance 36 month extended Gold Seal Limited warranty covers any defect in workmanship for an additional 12 months over the standard product warranty. Does not cover failure from lack of preventive maintenance or misapplication. See separate data sheet for complete details.

Drip Proof Guarded ¹

- 180V Armature
- 100V or 200V Field
- Power Code 2/2-230-60-0
- Suitable for Constant Torque to 50% Base Speed.

Features

- Continuous Duty
- Class F Insulation
- 40°C Ambient
- 1.0 Service Factor
- Straight Shunt Wound Fields³

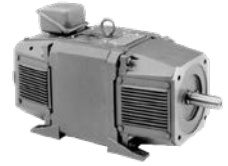

DC Motors 1 - 5 Hp

Hp	RPM	Nominal by Field Control	DPFG Frame
1	1750	1750	DC189ATZ
	1150	1150	DC189ATZ
	850	1020	DC189ATZ
1-1/2	3500	3500	C1811ATZ
	2500	2500	DC189ATZ
	1750	1750	DC189ATZ
	1150	1380	DC189ATZ
	850	1020	DC189ATZ
2	3500	3500	C1811ATZ
	2500	2500	DC189ATZ
	1750	1750	DC189ATZ
	1150	1380	DC189ATZ
	850	1020	C1811ATZ
3	3500	3500	C1811ATZ
	2500	2500	DC189ATZ
	1750	1750	DC189ATZ ³
	1150	1380	DC1811ATZ
	850	1020	SC2113ATZ
	650	1000	²
5	3500	3500	C1811ATZ
	2500	2500	DC1810ATZ
	1750	1835	DC1810ATZ ³
	1150	1380	SC2113ATZ
	850	1020	²
	650	1000	²

Notes: ¹ Frame size for DPG enclosure If DPG-FV enclosure is required, refer to Drip Proof Guarded Forced Ventilated page for frame size.

² Refer to a local ABB Sales Office for frame.

³ Stock 180 volt armature motors have straight shunt winding, i.e., no series field, for motors having a field weakened speed not greater than 1.05% base speed.

Multiplier Symbol: N2

Drip Proof Guarded ¹

- 240V Armature
- 150V or 240V Field
- Power Code C
- 500V Armature
- 240V or 300V Field
- Power Code C

Features

- Continuous Duty
- 1.0 Service Factor
- Class F Insulation
- Straight Shunt Wound Fields
- 40°C Ambient



DC Motors 1 - 250 Hp

Hp	Base Speed	Nominal by Field Control	DPG Frame 240 Volt ¹	Nominal by Field Control	DPG Frame 500 Volt ¹
1	1750	1950	DC189ATZ	1950	C1811ATZ
	1150	1380	DC189ATZ	1380	C1811ATZ
	850	1020	DC189ATZ	1020	C1811ATZ
1.5	3500	3500	C1811ATZ		²
	2500	2875	DC189ATZ		²
	1750	1950	DC189ATZ	1950	C1811ATZ
	1150	1380	DC189ATZ	1380	C1811ATZ
	850	1020	DC189ATZ	1020	C1811ATZ
2	3500	3500	C1811ATZ	3500	²
	2500	2500	DC189ATZ	2500	C1811ATZ
	1750	1950	DC189ATZ	1950	C1811ATZ
	1150	1380	DC189ATZ	1380	C1811ATZ
	850	1020	DC1811ATZ	1020	C1811ATZ
3	3500	3500	C1811ATZ		²
	2500	2800	DC189ATZ	2875	C1811ATZ
	1750	1950	DC189ATZ	1950	C1811ATZ
	1150	1380	DC1810ATZ	1380	C1811ATZ
	850	1020	C1812ATZ	1020	C1812ATZ
	650	1600	SC2113ATZ	1000	SC2113ATZ
	500	1500		²	²
	400	1200		²	²
5	3500	3500	C1811ATZ		²
	2500	2800	C1811ATZ	2875	C1811ATZ
	1750	1950	C1811ATZ	1950	C1811ATZ
	1150	1380	C1812ATZ	1380	C1812ATZ
	850	1020	SC2113ATZ	1020	SC2113ATZ
	650	1600	MC2113ATZ	1000	MC2113ATZ
	500	1500		²	²
	400	1200		²	²
	300	900		²	²

Notes: ¹ Frame size for DPG enclosure If DPG-FV enclosure is required, refer to Drip Proof Guarded Forced Ventilated page for frame size.

² Refer to a local ABB Sales Office for frame.

³ Stock 180 volt armature motors have straight shunt winding, i.e., no series field, for motors having a field weakened speed not greater than 105% base speed.

Multiplier Symbol: N2

Drip Proof Guarded ¹ (continued)

Hp	Base Speed	Nominal by Field Control	DPG Frame 240 Volt ¹	Nominal by Field Control	DPG Frame 500 Volt ¹
7.5	3500	3500	C1811ATZ		²
	2500	2875	C1811ATZ	2875	C1811ATZ
	1750	1950	C1811ATZ	1950	C1811ATZ
	1150	1380	SC2113ATZ	1380	SC2113ATZ
	850	1020	LC2113ATZ	1020	LC2113ATZ
	650	1600	SC2512ATZ	1000	SC2512ATZ
	500	1500	²	1500	²
	400	1200	²	1200	²
10	300	900	²	900	²
	3500	3500	C1811ATZ	3500	C1811ATZ
	2500	2875	C1811ATZ	2875	C1811ATZ
	1750	1950	C1812ATZ	1950	C1812ATZ
	1150	1380	MC2113ATZ	1380	MC2113ATZ
	850	1020	SC2512ATZ	1020	SC2512ATZ
	650	1000	LC2512ATZ	1000	LC2512ATZ
	3500	3500	C1812ATZ	3500	C1811ATZ
15	2500	2875	C1812ATZ	2875	C1812ATZ
	1750	1950	SC2113ATZ	1950	SC2113ATZ
	1150	1380	SC2512ATZ	1380	SC2512ATZ
	850	1020	LC2512ATZ	1020	LC2512ATZ
	650	1000	LC2812ATZ	1000	LC2812ATZ
	3500	3500	SC2113ATZ	3500	SC2113ATZ
	2500	2875	SC2113ATZ	2875	SC2113ATZ
	1750	1950	LC2113ATZ	1950	MC2113ATZ
20	1150	1380	MC2512ATZ	1380	MC2512ATZ
	850	1020	MC2812ATZ	1020	MC2812ATZ
	650	1000	MC3212ATZ	1000	MC3212ATZ
	3500	3500	MC2113ATZ	3500	MC2113ATZ
	2500	2875	MC2113ATZ	2875	MC2113ATZ
	1750	1950	LC2113ATZ	1950	LC2113ATZ
	1150	1380	LC2512ATZ	1380	LC2512ATZ
	850	1020	LC2812ATZ	1020	LC2812ATZ
25	650	1000	LC3212ATZ	1000	LC3212ATZ
	3500	3500	LC2113ATZ	3500	LC2113ATZ
	2500	2875	LC2113ATZ	2875	LC2113ATZ
	1750	1950	SC2512ATZ	1950	SC2512ATZ
	1150	1380	MC2812ATZ	1380	MC2812ATZ
	850	1020	MC3212ATZ	1020	MC3212ATZ
	650	1000	MC3612ATZ	1000	MC3612ATZ
	30	1000	MC3612ATZ	1000	MC3612ATZ

Notes: ¹ Frame size for DPG enclosure If DPG-FV enclosure is required, refer to Drip Proof Guarded Forced Ventilated page for frame size.

² Refer to a local ABB Sales Office for frame.

³ Stock 180 volt armature motors have straight shunt winding, i.e., no series field, for motors having a field weakened speed not greater than 105% base speed.

Multiplier Symbol: N2

Drip Proof Guarded ¹ (continued)

Hp	Base Speed	Nominal by Field Control	DPG Frame 240 Volt ¹	Nominal by Field Control	DPG Frame 500 Volt ¹
40	3500	3500	SC2512ATZ	3500	SC2512ATZ
	2500	2875	SC2512ATZ	2875	SC2512ATZ
	1750	1950	LC2512ATZ	1950	LC2512ATZ
	1150	1380	LC2812ATZ	1380	SC3210ATZ
	850	1020	LC3212ATZ	1020	LC3212ATZ
	650	1000	LC3612ATZ	1000	LC3612ATZ
50	3500	3500	MC2512ATZ	3500	MC2512ATZ
	2500	2875	MC2512ATZ	2875	MC2512ATZ
	1750	1950	MC2812ATZ	1950	MC2812ATZ
	1150	1380	MC3212ATZ	1380	MC3212ATZ
	850	1020	MC3612ATZ	1020	MC3612ATZ
60	3500	3500	LC2512ATZ	3500	LC2512ATZ
	2500	2875	LC2512ATZ	2875	LC2512ATZ
	1750	1950	LC2812ATZ	1950	LC2812ATZ
	1150	1380	LC3212ATZ	1380	LC3212ATZ
	850	1020	LC3612ATZ	1020	LC3612ATZ
75	3500	3500	MC2812ATZ	3500	MC2812ATZ
	2500	2875	MC2812ATZ	2875	MC2812ATZ
	1750	1950	MC3212ATZ	1950	MC3212ATZ
	1150	1380	MC3612ATZ	1380	MC3612ATZ
	850	1020	²	1020	C4011ATZ
100	3500	3500	²	3500	LC2812ATZ
	2500	2500	LMC3212ATZ	2500	LC2812ATZ
	1750	2000	LLC3212ATZ	2000	LC3212ATZ
	1150	1380	LLC3612ATZ	1380	LC3612ATZ
	850	1020	²	1020	MC4013ATZ
125	2500	2500	²	2500	MC3212ATZ
	1750	2000	²	2000	MC3612ATZ
	1150	1380	²	1380	C4011ATZ
	2500	2500	²	2500	LC3212ATZ
150	1750	2000	C4011ATZ	2000	LC3612ATZ
	1150	1380	MC4013ATZ	1380	MC4013ATZ
	2500	2500	²	2500	MC3612ATZ
200	1750	1900	²	1900	C4011ATZ
	2500	2000	²	2000	MC4013ATZ

Notes: See page 47

Multiplier Symbol: N2

Drip Proof Guarded Force Ventilated ^{1 3}

Complete with Motor Mounted Blower ⁵

- 180V Armature
- 100V or 200V
- Power Code 2/2-230-60-0

Features

- Continuous Duty
- Class F Insulation

- 40oc Ambient
- 1.0 Service Factor
- Straight Shunt Wound Fields⁴



DC Motors 1 - 7.5 Hp

Hp	RPM	Nominal by Field Control	DPG-FV Frame
1	1750	1750	DC189ATZ
	1150	1150	DC189ATZ
	850	1020	DC189ATZ
1.5	3500	3500	C1811ATZ
	2500	2500	DC189ATZ
	1750	1750	DC189ATZ
	1150	1380	DC189ATZ
	850	1020	DC189ATZ
2	3500	3500	C1811ATZ
	2500	2500	DC189ATZ
	1750	1750	DC189ATZ
	1150	1380	DC189ATZ
	850	1020	DC189ATZ
3	3500	3500	C1811ATZ
	2500	2500	DC189ATZ
	1750	1750	DC189ATZ
	1150	1380	DC189ATZ
	850	1020	C1811ATZ
	650	1000	²
5	3500	3500	C1811ATZ
	2500	2500	DC1810ATZ
	1750	1835	DC1810ATZ
	1150	1380	C1812ATZ
	850	1020	²
	650	1000	²
7.5	1750	1750	C1812ATZ

Notes: ¹ Frame size also suitable for separately ventilated enclosure, DPG-SV. Motor must have cooling air supplied when fields are excited at rated voltage.
² Refer to a local ABB Sales Office for frame.
³ Frame size for DPG-FV enclosure. If DPG enclosure is required, refer to Drip Proof Guarded page for frame size.
⁴ Stock 180 volt armature motors have straight shunt winding, i.e., no series field, for motors having a field weakened speed not greater than 105% base speed.
⁵ Force ventilation construction is standard. Motor mounted blower without filter with motor for 3-phase, 60 Hz, 240/480 volts AC power supply is included in list price. Motor must have cooling air supplied when fields are excited at rated voltage.
⁶ Motor speed under any condition must not exceed Maximum Safe Speed listed on nameplate.
⁷ Motor must be speed regulated and/or speed limit switch must be included to limit speed on winder duty.
⁸ Refer to modification section for description of winder duty.
⁹ Continuous and winder duty maximum field weakened speeds shown are for frame size listed additional field weakened speeds may be attained by using larger motor. Contact a local ABB Sales Office to confirm frame size.
¹⁰ Motor requires external inductance (not supplied by ABB).

Multiplier Symbol: N2

Drip Proof Guarded Force Ventilated^{1 3}

Complete with Motor Mounted Blower⁵

- 240V Armature
- 150V or 240V field
- Power Code C
- 500V Armature
- 240V or 300V field
- Power Code C
- Features**
- Continuous Duty
- 1.0 Service Factor
- Class F Insulation
- Straight Shunt Wound Fields
- 40°C Ambient



DC Motors 1 - 250 Hp

Hp	Base Speed	Nominal by Field Control	DPG-FV Frame 240 Volt	Nominal by Field Control	DPG-FV Frame 500 Volt
1	1750	1950	DC189ATZ	1950	C1811ATZ
	1150	1380	DC189ATZ	1380	C1811ATZ
	850	1020	DC189ATZ	1020	C1811ATZ
1-1/2	3500	3500	C1811ATZ	—	(2)
	2500	2875	DC189ATZ	—	(2)
	1750	1950	DC189ATZ	1950	C1811ATZ
	1150	1380	DC189ATZ	1380	C1811ATZ
	850	1020	DC189ATZ	1020	C1811ATZ
2	3500	3500	C1811ATZ	—	(2)
	2500	2800	DC189ATZ	2500	C1811ATZ
	1750	1950	DC189ATZ	1950	C1811ATZ
	1150	1380	DC189ATZ	1380	C1811ATZ
	850	1020	DC189ATZ	1020	C1811ATZ
3	3500	3500	C1811ATZ	—	(2)
	2500	2800	DC189ATZ	2875	C1811ATZ
	1750	1950	DC189ATZ	1950	C1811ATZ
	1150	1380	DC189ATZ	1380	C1811ATZ
	850	1020	C1811ATZ	1020	C1811ATZ
	650	1600	C1812ATZ	1000	C1812ATZ
	500	1500	C1812ATZ	1000	C1812ATZ
	400	1200	SC2113ATZ	800	SC2113ATZ
	300	900	MC2113ATZ	600	MC2113ATZ
	5	3500	3500	C1811ATZ	—
2500		2875	C1811ATZ	2875	C1811ATZ
1750		1950	C1811ATZ	1950	C1811ATZ
1150		1380	C1811ATZ	1380	C1811ATZ
850		1020	C1811ATZ	1020	C1812ATZ
650		1600	SC2113ATZ	1000	SC2113ATZ
500		1500	MC2113ATZ	1000	MC2113ATZ
400		1200	MC2113ATZ	800	MC2113ATZ
300		900	SC2512ATZ	600	LC2113ATZ
7-1/2		3500	3500	C1811ATZ	3500
	2500	2875	C1811ATZ	2875	C1811ATZ
	1750	1950	C1811ATZ	1950	C1811ATZ
	1150	1380	C1812ATZ	1380	C1812ATZ
	850	1020	SC2113ATZ	1020	SC2113ATZ
	650	1000	SC2113ATZ	1000	MC2113ATZ
	500	950	LC2113ATZ	950	LC2113ATZ
	400	800	MC2115ATZ	800	MC2115ATZ
	300	600	LC2115ATZ	600	LC2115ATZ

Notes: See page 51.

Multiplier Symbol: N2

Drip Proof Guarded Force Ventilated ^{1 3} (continued)
 Complete with Motor Mounted Blower ⁵

Hp	Base Speed	Nominal by Field Control	DPG-FV Frame 240 Volt	Nominal by Field Control	DPG-FV Frame 500 Volt
10	3500	3500	C1811ATZ	3500	C1811ATZ
	2500	2875	C1811ATZ	2875	C1811ATZ
	1750	1950	C1812ATZ	1950	C1812ATZ
	1150	1380	SC2113ATZ	1380	SC2113ATZ
	850	1020	SC2113ATZ	1020	SC2113ATZ
	650	1000	MC2113ATZ	1000	MC2115ATZ
	500	950	MC2115ATZ	950	MC2115ATZ
	400	800	LC2115ATZ	800	MC2512ATZ
	300	600	LC2512ATZ	600	LC2512ATZ
15	3500	3500	C1811ATZ	3500	C1812ATZ
	2500	2875	C1812ATZ	2875	C1812ATZ
	1750	1950	SC2113ATZ	1950	SC2113ATZ
	1150	1380	MC2113ATZ	1380	MC2113ATZ
	850	1020	LC2113ATZ	1020	LC2113ATZ
	650	1000	LC2115ATZ	1000	LC2115ATZ
	500	1000	LC2512ATZ	1000	LC2512ATZ
	400	800	C2514ATZ	800	C2514ATZ
	300	600	LC2812ATZ	600	LC2812ATZ
20	3500	3500	SC2113ATZ	3500	SC2113ATZ
	2500	2875	SC2113ATZ	2875	SC2113ATZ
	1750	1950	SC2113ATZ	1950	SC2113ATZ
	1150	1380	LC2113ATZ	1380	LC2113ATZ
	850	1020	SC2512ATZ	1020	LC2115ATZ
	650	1000	LC2512ATZ	1000	LC2512ATZ
	500	1000	C2514ATZ	1000	C2514ATZ
	400	800	LC2812ATZ	800	LC2812ATZ
	300	600	C2815ATZ	600	C2815ATZ
25	3500	3500	SC2113ATZ	3500	SC2113ATZ
	2500	2875	SC2113ATZ	2875	SC2113ATZ
	1750	1950	MC2113ATZ	1950	MC2113ATZ
	1150	1380	LC2115ATZ	1380	MC2115ATZ
	850	1020	MC2512ATZ	1020	MC2512ATZ
	650	1000	C2514ATZ	1000	C2514ATZ
	500	1300	LC2812ATZ	1300	LC2812ATZ
	400	1000	C2813ATZ	1000	C2815ATZ
	300	600	C3214ATZ	600	C3214ATZ
30	3500	3500	SC2113ATZ	3500	SC2113ATZ
	2500	2875	SC2113ATZ	2875	SC2113ATZ
	1750	1950	LC2113ATZ	1950	LC2113ATZ
	1150	1380	LC2115ATZ	1380	LC2115ATZ
	850	1020	LC2512ATZ	1020	LC2512ATZ
	650	1000	C2514ATZ	1000	C2515ATZ
	500	1300	C2813ATZ	1300	C2815ATZ
	400	1200	LC3212ATZ	1200	C2815ATZ
	300	900	C3214ATZ	900	C3214ATZ

Notes: See page 51.
 Multiplier Symbol: N2

Drip Proof Guarded Force Ventilated ^{1 3} (continued)

Complete with Motor Mounted Blower ⁵

Hp	Base Speed	Nominal by Field Control	DPG-FV Frame 240 Volt	Nominal by Field Control	DPG-FV Frame 500 Volt
40	3500	3500	LC2113ATZ	3500	LC2113ATZ
	2500	2875	LC2113ATZ	2875	LC2113ATZ
	1750	1950	LC2115ATZ	1950	MC2115ATZ
	1150	1380	LC2512ATZ	1380	LC2512ATZ
	850	1020	C2514ATZ	1020	C2514ATZ
	650	1000	C2813ATZ	1000	C2515ATZ
	500	1100	C2815ATZ	1100	C2815ATZ
	400	1000	C3214ATZ	1000	C3214ATZ
50	300	900	C3613ATZ	900	C3613ATZ
	3500	3500	SC2512ATZ	3500	MC2115ATZ
	2500	2875	SC2512ATZ	2875	LC2115ATZ
	1750	1950	MC2512ATZ	1950	LC2115ATZ
	1150	1380	C2514ATZ	1380	C2514ATZ
	850	1020	C2813ATZ	1020	C2515ATZ
	650	1000	C2815ATZ	1000	C2815ATZ
	500	1400	LC3214ATZ	1400	C3214ATZ
60	400	1200	L3612ATZ	1200	LC3612ATZ
	300	900	C3613ATZ	900	C3613ATZ
	3500	3500	SC2512ATZ	3500	MC2115ATZ
	2500	2875	MC2512ATZ	2875	LC2115ATZ
	1750	1950	LC2512ATZ	1950	LC2512ATZ
	1150	1380	C2515ATZ	1380	C2515ATZ
	850	1020	C2813ATZ	1020	C2815ATZ
	650	1000	C3214ATZ	1000	C3214ATZ
75	500	1500	LC3612ATZ	1500	LC3612ATZ
	400	1200	C3613ATZ	1200	C3613ATZ
	300	900	MC4013ATZ	900	LC4013ATZ
	3500	3500	MC2812ATZ	3500	MC2512ATZ
	2500	2875	MC2812ATZ	2875	LC2512ATZ
	1750	1950	MC2812ATZ	1950	C2514ATZ
	1150	1380	C2813ATZ	1380	MC3212ATZ
	850	1020	C2815ATZ	1020	C2815ATZ
100	650	1000	LC3612ATZ	1000	LC3612ATZ
	500	1500	C3613ATZ	1500	MC4013ATZ
	400	1200	C3613ATZ	1200	MC4013ATZ
	300	900	MC4013ATZ	900	LC4013ATZ
	4000	4000		4000	MC2812ATZ
	3500	3500		3500	MC2812ATZ
	2500	2500	LC2812ATZ	2500	MC2812ATZ
	1750	2000	LC2812ATZ	2000	C2515ATZ
	1150	1380	LLC3212ATZ	1380	C2815ATZ
	850	1020		1020	C4011ATZ
	650	1600	LC3612ATZ	1600	C3613ATZ
	500	1500	C3613ATZ	1500	MC4013ATZ
	400	1200	C4412ATZ	1200	C4413ATZ
	300	900	C4414ATZ	900	C4414ATZ

Notes: See page 51.

Multiplier Symbol: N2

Drip Proof Guarded Force Ventilated ^{1 3} (continued)

Complete with Motor Mounted Blower ⁵

Hp	Base Speed	Nominal by Field Control	DPG-FV Frame 240 Volt	Nominal by Field Control	DPG-FV Frame 500 Volt
125	3500	3500	²	3500	MC3212ATZ
	2500	2500	²	2500	LC2812ATZ
	1750	2000	LLC3212ATZ	2000	C2813ATZ
	1150	1380	LC3214ATZ	1380	C3214ATZ
	850	1020	LLC3612ATZ	1020	LC3612ATZ
	650	1600	C4011ATZ	1600	MC4013ATZ
	500	1350	²	1350	LC4013ATZ
	400	1050	C4413ATZ	1050	C4413ATZ
	300	800	²	800	C4414ATZ
150	3500	3500	²	3500	LC3212ATZ
	2500	2875	²	2875	LC3212ATZ
	1750	2000	LMC3612ATZ	2000	C2815ATZ
	1150	1380	MC4013ATZ	1380	MC4013ATZ
	850	1020	C4011ATZ	1020	C3613ATZ
	650	1450	²	1450	MC4013ATZ
	500	1150	²	1150	C4412ATZ
	200	2875	²	2875	C3214ATZ
200	1750	1900	²	1900	C3214ATZ
	1150	1380	C4011ATZ	1380	MC4013ATZ
	850	1020	LC4013ATZ	1020	MC4013ATZ
	650	1600	²	1600	C4413ATZ
	500	1300	²	1300	C4414ATZ
	250	2875	²	2875	MC3612ATZ
250	1750	1750	²	1750	LC3612ATZ
	1150	1380	²	1380	MC4013ATZ
	850	1020	²	1020	C4413ATZ
	650	1350	²	1350	C4413ATZ

Notes: ¹ Frame size also suitable for separately ventilated enclosure, DPG-SV. Motor must have cooling air supplied when fields are excited at rated voltage.

² Refer to a local ABB Sales Office for frame.

³ Frame size for DPG-FV enclosure. If DPG enclosure is required, refer to Drip Proof Guarded page for frame size.

⁴ Stock 180 volt armature motors have straight shunt winding, i.e., no series field, for motors having a field weakened speed not greater than 105% base speed.

⁵ Force ventilation construction is standard. Motor mounted blower without filter with motor for 3-phase, 60 Hz, 240/480 volts AC power supply is included in list price.

Motor must have cooling air supplied when fields are excited at rated voltage.

⁶ Motor speed under any condition must not exceed Maximum Safe Speed listed on nameplate.

⁷ Motor must be speed regulated and/or speed limit switch must be included to limit speed on winder duty.

⁸ Refer to modification section for description of winder duty.

⁹ Continuous and winder duty maximum field weakened speeds shown are for frame size listed additional field weakened speeds may be attained by using larger motor.

Contact a local ABB Sales Office to confirm frame size.

¹⁰ Motor requires external inductance (not supplied by ABB).

Multiplier Symbol: N2

Drip Proof Guarded Force Ventilated ¹ (continued)

Complete with Motor Mounted Blower ⁵

- 500V Armature
 - 300-500 Hp (As Indicated)
 - Power Code C
- Features**
- Continuous Duty
 - Class F Insulation
 - 40°C Ambient
 - 1.0 Service Factor
 - Straight Shunt Wound Fields

DC Motors 300 - 500 Hp

Hp	Base Speed	Nominal FW Speed (RPM) (1)	Armature Volts	DPG-FV Frame	Extended Field Range ^{(6) (9)}		Percentage Addition to Basic Motor Price for Maximum Field Weakened Speed
					Cont Duty Max FW Speed (rpm) ⁽⁶⁾	Winder Duty Max FW Speed (rpm) ^{(6) (7) (8)}	
300	1750	1900	500	LC3613ATZ	2300	—	0
	1150	1600	500	LC4013ATZ	2000	—	0
	850	1300	500	C4413ATZ	1700	2200	10
	650	1050	500	C4414ATZ	1375	1825	10
400	1750	1900	500	MC4013ATZ	2000	—	—
	1150	1600	500	C4413ATZ	—	—	—
	850	1000	500	C4414ATZ	1300	—	10
500	1750	2000	500	C4412ATZ	—	—	—
	1150	1450	500	C4414ATZ	—	1600	5

Notes: See page 51.

Multiplier Symbol: N2

Totally Enclosed Fan Cooled

- 240V Armature
- 150V or 240V Field
- Power Code C
- 500V Armature
- 240V or 300V Field
- Power Code C

Features

- Continuous Duty
- Class F Insulation
- 40°C Ambient
- 1.0 Service Factor
- Straight Shunt Wound Fields



DC Motors 2 - 75 Hp

Hp	Speed, RPM		TEFC Frame	
	Base Speed	Nominal by Field Control	240V	500V
2	850	1020	C1812ATZ	C1812ATZ
3	1150	1380	C1812ATZ	C1812ATZ
	850	1020	SC2113ATZ	SC2113ATZ
5	2500	2875	C1811ATZ	C1811ATZ
	1750	2000	C1812ATZ	C1812ATZ
	1150	1380	MC2113ATZ	MC2113ATZ
	850	1020	SC2512ATZ	SC2512ATZ
7-1/2	3500	3500	C1812ATZ	²
	2500	2875	SC2113ATZ	SC2113ATZ
	1750	1950	SC2113ATZ	SC2113ATZ
	1150	1380	SC2512ATZ	SC2512ATZ
	850	1020	LC2512ATZ	LC2512ATZ
	650	1600	²	²
10	500	1500	²	²
	2500	2875	SC2113ATZ	SC2113ATZ
	1750	1950	MC2113ATZ	MC2113ATZ
	1150	1380	MC2512ATZ	MC2512ATZ
	850	1020	MC2812ATZ	MC2812ATZ
	650	1600	²	²
15	500	1500	²	²
	2500	2875	LC2113ATZ	²
	1750	1950	SC2512ATZ	SC2512ATZ
	1150	1380	MC2812ATZ	MC2812ATZ
	850	1020	MC3212ATZ	MC3212ATZ
	650	1600	²	²
20	500	1500	MC3612ATZ	²
	2500	2875	SC2512ATZ	SC2512ATZ
	1750	1950	LC2512ATZ	LC2512ATZ
	1150	1380	LC2812ATZ	LC2812ATZ
	850	1020	LC3212ATZ	LC3212ATZ
	650	1600	²	²
20	500	1500	C4011ATZ	²
	400	1200	MC4013ATZ	²

Hp	Speed, RPM		TEFC Frame	
	Base Speed	Nominal by Field Control	240V	500V
25	2500	2875	LC2512ATZ	LC2512ATZ
	1750	1950	MC2812ATZ	MC2812ATZ
	1150	1380	MC3212ATZ	MC3212ATZ
	850	1020	LC3212ATZ	LC3212ATZ
	650	1600	LC3612ATZ	²
30	500	1500	MC4013ATZ	²
	400	1200	²	²
	2500	2875	MC2812ATZ	MC2812ATZ
	1750	1950	LC2812ATZ	LC2812ATZ
	1150	1380	LC3212ATZ	LC3212ATZ
40	850	1020	MC3612ATZ	LC3612ATZ
	650	1600	C4011ATZ	MC4013ATZ
	500	1500	MC4013ATZ	²
	400	1200	²	²
	2500	2875	LC2812ATZ	LC2812ATZ
	1750	1950	MC3212ATZ	MC3212ATZ
50	1150	1380	MC3612ATZ	MC3612ATZ
	850	1020	LC3612ATZ	C4011ATZ
	650	1600	MC4013ATZ	LC4013ATZ
	500	1500	MC4013ATZ	²
	2500	2875	MC3212ATZ	MC3212ATZ
	1750	2100	LC3212ATZ	LC3212ATZ
60	1150	2000	LC3612ATZ	LC3612ATZ
	850	1020	MC4013ATZ	MC4013ATZ
	650	1600	MC4013ATZ	²
	2500	2500	LC3212ATZ	LC3212ATZ
75	1750	2100	MC3612ATZ	MC3612ATZ
	1150	2000	MC4013ATZ	MC4013ATZ
	850	1020	MC4013ATZ	MC4013ATZ
	650	1600	²	²

Notes: ² Refer to a local ABB Sales Office for frame.
Multiplier Symbol: N2

Totally Enclosed Non-Ventilated

- 180V Armature
- 100V or 200V Field
- Power Code 2/2-230-60-0
- Suitable for Constant Torque to 1% Base Speed ¹⁴

Features

- Continuous Duty
- Class F Insulation
- 40°C Ambient
- 1.0 Service Factor
- Straight Shunt Wound Fields



DC Motors 1 - 5 Hp

Hp	Base Speed RPM	Nominal By Field Control	TENV Frame 180 Volt
1	1750	1750	DC189ATZ
	1150	1150	DC189ATZ
	850	1020	DC1811ATZ
	650	1350	DC1811ATZ
1.5	3500	3500	C1811ATZ
	2500	2500	DC189ATZ
	1750	1750	DC189ATZ
	1150	1380	DC1810ATZ
	850	1020	DC1811ATZ
	650	1300	DC2112ATZ
2	3500	3500	C1811ATZ
	2500	2500	DC189ATZ
	1750	1750	DC189ATZ
	1150	1380	DC1811ATZ
	850	1020	DC2112ATZ
	650	1300	LC2113ATZ
3	3500	3500	C1812ATZ
	2500	2750	DC1811ATZ
	1750	2050	DC1811ATZ ⁴
	1150	1380	DC2112ATZ
	850	1020	LC2113ATZ
	650	1000	SC2512ATZ
5	3500	3500	MC2113ATZ
	2500	2750	DC2112ATZ
	1750	2050	DC2112ATZ ⁴
	1150	1380	SC2512ATZ
	850	1020	LC2512ATZ
	650	1000	LC2512ATZ

Notes: ² Refer to a local ABB Sales Office for frame.

⁴ Stock 180 volt armature motors have straight shunt winding, i.e., no series field, for motors having a field weakened speed not greater than 105% base speed.

¹⁴ Based on maximum allowable temperature rise.

¹⁵ Fields rated 60 minutes duty. Continuous Duty Shunt Field Modification must be specified for continuous duty fields.

¹⁶ Series wound motors may have increased frame size. Refer to a local ABB Sales Office.

¹⁷ Price addition must be made for compound, series or stab shunt winding.

¹⁸ Fields rated 30 minutes duty.

Totally Enclosed Non-Ventilated

- 240V Armature
- 150V or 240V Field
- Power Code C
- 500V Armature
- 240V or 300V Field
- Power Code C

Features

- Continuous Duty
- Class F Insulation
- 40°C Ambient
- 1.0 Service Factor
- Straight Shunt Wound Fields

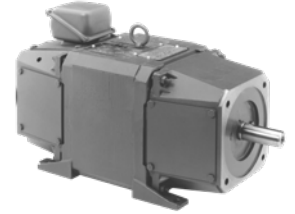

DC Motors 1 - 7.5 Hp

Hp	Base Speed	Nominal By Field Control	TENV Frame 240 Volt	Nominal By Field Control	TENV Frame 500 Volt
1	1750	1950	DC189ATZ	1950	C1811ATZ
	1150	1380	DC189ATZ	1265	C1811ATZ
	850	1020	DC189ATZ	935	C1811ATZ
	650	1600	DC1811ATZ	1300	C1812ATZ
1.5	3500	3500	C1811ATZ		²
	2500	2875	DC189ATZ	2500	C1811ATZ
	1750	1950	DC189ATZ	1925	C1811ATZ
	1150	1380	DC189ATZ	1265	C1811ATZ
	850	1020	DC1811ATZ	935	C1812ATZ
	650	1600	SC2113ATZ	1300	SC2113ATZ
2	3500	3500	C1811ATZ		²
	2500	2875	DC189ATZ	2500	C1811ATZ
	1750	1950	DC189ATZ	1925	C1811ATZ
	1150	1380	DC1811TZ	1265	C1812ATZ
	850	1020	SC2113ATZ	1020	SC2113ATZ
	650	1600	MC2113ATZ	1300	MC2113ATZ
3	3500	3500	C1811ATZ		²
	2500	2875	DC1810ATZ	2500	C1811ATZ
	1750	2050	DC1811ATZ	1925	C1812ATZ
	1150	1380	SC2113ATZ	1380	SC2113ATZ
	850	1020	LC2113ATZ	935	MC2113ATZ
	650	1600	SC2512ATZ	1000	SC2512ATZ
5	3500	3500	C1812ATZ		²
	2500	2875	SC2113ATZ	2875	SC2113ATZ
	1750	2050	SC2113ATZ	2050	SC2113ATZ
	1150	1380	SC2512ATZ	1380	SC2512ATZ
	850	1020	LC2512ATZ	1020	LC2512ATZ
	650	1600	MC2812ATZ	1000	MC2812ATZ
7.5	2500	2875	MC2113ATZ	2875	MC2113ATZ
	1750	1950	LC2113ATZ	1950	LC2113ATZ
	1150	1380	MC2512ATZ	1380	MC2512ATZ
	850	1020	LC2812ATZ	1020	LC2812ATZ
	650	1600	MC3212ATZ	1600	MC3212ATZ

Notes: See page 54.

Multiplier Symbol: N2

Totally Enclosed Non-Ventilated

- 240V Armature
- 150V or 240V Field
- Power Code C
- 500V Armature
- 240V or 300V Field
- Power Code C

Features

- Continuous Duty
- Class F. Insulation
- 40°C Ambient
- 1.0 Service Factor
- Straight Shunt Wound Fields

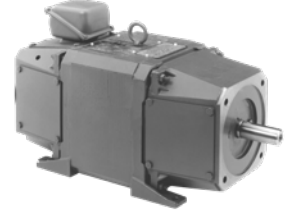

DC Motors 10 - 40 Hp

Hp	Base Speed	Nominal By Field Control	TENV Frame 240 Volt	Nominal By Field Control	TENV Frame 500 Volt
10	2500	2875	SC2512ATZ	2875	SC2512ATZ
	1750	1950	LC2512ATZ	1950	LC2512ATZ
	1150	1380	MC2812ATZ	1380	MC2812ATZ
	850	1020	MC3212ATZ	1020	MC3212ATZ
	650	1600	MC3612ATZ	1600	MC3612ATZ
15	2500	2875	MC2812ATZ	2875	MC2812ATZ
	1750	1950	LC2812ATZ	1950	LC2812ATZ
	1150	1380	MC3212ATZ	1380	MC3212ATZ
	850	1020	LC3612ATZ	1020	LC3612ATZ
	650	1600	²	1600	²
20	2500	2875	LC2812ATZ	2875	LC2812ATZ
	1750	1950	MC3212ATZ	1950	MC3212ATZ
	1150	1380	LC3612ATZ	1380	LC3612ATZ
	850	1020	²	1020	MC4013ATZ
	650	1600	²	1600	MC4013ATZ
25	2500	2875	MC3212ATZ	2875	MC3212ATZ
	1750	1950	MC3612ATZ	1950	MC3612ATZ
	1150	1380	C3613ATZ	1380	MC4013ATZ
	850	1020	²	1020	MC4013ATZ
	650	1600	²	1600	MC4013ATZ
30	2500	2875	MC3612ATZ	2875	LC3212ATZ
	1750	1950	LC3612ATZ	1950	LC3612ATZ
	1150	1380	MC4013ATZ	1380	²
	850	1020	²	1020	²
40	2500	2875	LC3612ATZ	2875	LC3612ATZ
	1750	1950	²	1950	LC3612ATZ

Notes: See page 54.

Multiplier Symbol: N2

Totally Enclosed Non-Ventilated

60 Minute Duty

- 240V Armature
- 150V or 240V Field¹⁵
- Power Code C
- 500V Armature
- 240V or 300V Field¹⁵
- Power Code C

Features

- 60 Minute Duty ¹⁵
- Class F Insulation
- 40°C Ambient
- 1.0 Service Factor
- Straight Shunt Wound Fields ¹⁷

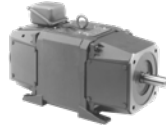

DC Motors 3 - 125 Hp

Hp	Speed, RPM		Frame ¹⁶ 240V or 500V
	Base Speed	Nominal by Field Control	
3	2500	2875	C1811ATZ
	1750	1950	C1811ATZ
	1150	1380	C1812ATZ
	850	1020	SC2113ATZ
	650	1600	SC2113ATZ
5	3500	3850	SC2113ATZ
	2500	2875	SC2113ATZ
	1750	1950	SC2113ATZ
	1150	1380	MC2113ATZ
	850	1020	LC2113ATZ
7.5	650	1600	MC2512ATZ
	3500	3850	SC2113ATZ
	2500	2875	SC2113ATZ
	1750	1950	SC2113ATZ
	1150	1380	LC2113ATZ
10	850	1020	SC2512ATZ
	650	1600	LC2512ATZ
	500	1500	²
	3500	3850	SC2113ATZ
	2500	2875	SC2113ATZ
15	1750	1950	MC2113ATZ
	1150	1380	SC2512ATZ
	850	1020	MC2512ATZ
	650	1600	MC2812ATZ
	500	1500	²
15	3500	3850	LC2113ATZ
	2500	2875	LC2113ATZ
	1750	1950	SC2512ATZ
	1150	1380	LC2512ATZ
	850	1020	MC2812ATZ
15	650	1600	MC3212ATZ
	500	1500	²

Notes: See page 54.
Multiplier Symbol: N2

Hp	Speed, RPM		Frame ¹⁶ 240V or 500V
	Base Speed	Nominal by Field Control	
20	2500	2875	SC2512ATZ
	1750	1950	MC2512ATZ
	1150	1380	MC2812ATZ
	850	1020	LC2812ATZ
	650	1600	LC3212ATZ
25	500	1500	²
	2500	2875	MC2512ATZ
	1750	1950	LC2512ATZ
	1150	1380	LC2812ATZ
	850	1020	MC3212ATZ
25	650	1600	MC3612ATZ
	500	1500	²
	2500	2875	MC2812ATZ
	1750	1950	MC2812ATZ
	1150	1380	LC3212ATZ
30	850	1020	MC3612ATZ
	650	1600	LC3612ATZ
	500	1500	²
	2500	2875	LC2812ATZ
	1750	1950	LC2812ATZ
40	1150	1380	LC3212ATZ
	850	1020	MC3612ATZ
	650	1600	LC3612ATZ
	500	1500	²
	2500	2875	LC2812ATZ
40	1750	1950	LC2812ATZ
	1150	1380	LC3212ATZ
	850	1020	LC3612ATZ
	650	1600	²
	500	1500	²
50	1750	1950	MC3212ATZ
	1150	1380	²
	850	1020	²
	650	1600	²
	500	1500	²
60	1750	1950	MC3212ATZ
	1150	1380	²
	850	1020	MC4013ATZ
	650	1600	²
	500	1500	²
75	1750	1950	MC3612ATZ
	1150	1380	LC3612ATZ
	850	1020	C3613ATZ
	650	1600	²
	500	1500	²
100	1750	1950	MC3612ATZ
	1150	1380	LC3612ATZ
	850	1020	LC4013ATZ
	650	1600	²
	500	1500	²
125	1750	1950	MC3612ATZ
	1150	1380	²
	850	1020	C4414ATZ
	650	1600	²
	500	1500	²

Totally Enclosed Non-Ventilated 30 Minute Duty

- 240V Armature
 - 150V or 240V Field¹⁸
 - Power Code C
 - 500V Armature
 - 240V or 300V Field¹⁸
 - Power Code C
- Features**
- 30 Minute Duty¹⁸
 - Class F Insulation
 - 40°C Ambient
 - 1.0 Service Factor
 - Straight Shunt Wound Fields¹⁷



DC Motors 1 - 150 Hp

Hp	Base Speed RPM	Frame ¹⁶ 240V or 500V
1	850	²
1.5	1150	²
	850	²
2	1750	²
	1150	²
	850	C1811ATZ
	650	C1812ATZ
3	1750	²
	1150	C1811ATZ
	850	C1812ATZ
	650	SC2113ATZ
5	1750	C1811ATZ
	1150	C1812ATZ
	850	MC2113ATZ
	650	MC2113ATZ
7.5	3500	C1812ATZ
	2500	C1812ATZ
	1750	C1812ATZ
	1150	MC2113ATZ
	850	LC2113ATZ
	650	MC2512ATZ
10	3500	C1812ATZ
	2500	C1812ATZ
	1750	SC2113ATZ
	1150	MC2113ATZ
	850	LC2113ATZ
	650	MC2512ATZ
15	3500	SC2113ATZ
	2500	SC2113ATZ
	1750	MC2113ATZ
	1150	SC2512ATZ
	850	MC2512ATZ
	650	MC2812ATZ

Hp	Base Speed RPM	Frame ¹⁶ 240V or 500V
20	3500	SC2113ATZ
	2500	SC2113ATZ
	1750	LC2113ATZ
	1150	MC2512ATZ
	850	LC2512ATZ
	650	LC2812ATZ
25	3500	LC2113ATZ
	2500	LC2113ATZ
	1750	SC2512ATZ
	1150	LC2512ATZ
	850	MC2812ATZ
	650	MC3212ATZ
30	2500	SC2512ATZ
	1750	MC2512ATZ
	1150	MC2812ATZ
	850	LC2812ATZ
	650	LC3212ATZ
40	2500	MC2512ATZ
	1750	LC2512ATZ
	1150	LC2812ATZ
	850	MC3212ATZ
	650	MC3612ATZ
50	2500	LC2512ATZ
	1750	MC2812ATZ
	1150	MC3212ATZ
	850	LC3212ATZ
	650	LC3612ATZ
60	2500	MC2812ATZ
	1750	LC2812ATZ
	1150	LC3212ATZ
	850	LC3612ATZ
	650	²
75	2500	LC2812ATZ
	1750	MC3212ATZ
	1150	MC3612ATZ
	850	LC3612ATZ
	650	²
100	2500	MC3212ATZ
	1750	LC3212ATZ
	1150	LC3612ATZ
125	2500	MC3612ATZ
	1750	MC3612ATZ
150	2500	LC3612ATZ
	1750	LC3612ATZ

Notes: See page 54.
Multiplier Symbol: N2

Totally Enclosed Explosion Proof

- 180V Armature
- 100 V or 200V Field
- Power Code K ¹⁹

Features

- Continuous Duty
- Class F Insulation
- 40°C Ambient
- 1.0 Service Factor
- Straight Shunt Wound Fields
- Thermostat
- Class B or F Rise

Caution:

The application of motors and other electrical equipment in hazardous locations is restricted by the National Electrical Code. Customers must observe these regulations and consult with local code inspection and enforcement agencies to insure compliance. Motors listed by Underwriters Laboratories, Inc. for use in specific locations are listed for user in the specified location only.

Explosion-proof motors have one or more thermostats designed to trip before the frame reaches the maximum allowable temperature for the specific class and group.

The normally closed contacts of the thermostat **MUST** be connected in the motor control circuit so that power to the motor armature and field is removed immediately when the thermostat strips. An explosion-proof tachometer mounted on the motor will also have an internal thermostat which must be connected to stop the drive immediately upon tripping.

DC Motors 1 - 5 Hp

Hp	Class I Group C & D, Class II Group E, F & G			
	Base Speed RPM	Nominal By Field Control	TEFC Frame	TENV Frame
1	1750	2050	XC1811ATY	XC1811ATY
	1150	1380	XC1811ATY	XC1811ATY
	2500	2750	XC1811ATY	XC1811ATY
1-1/2	1750	2050	XC1811ATY	XC1811ATY
	1150	1380	XC1812ATY	XC1812ATY
	2500	2750	XC1811ATY	XC1812ATY
2	1750	2050	XC1811ATY	XC1812ATY
	1150	1380	XC1812ATY	XC257ATY
	2500	2750	XC1812ATY	XC257ATY
3	1750	2050	XC1812ATY	XC257ATY
	1150	1380	XC257ATY	XC257ATY
	2500	2750	XC257ATY	XC257ATY
5	1750	2050	XC257ATY	XC257ATY
	1150	1380	XC258ATY	XC259ATY

Explosion-Proof Motor Availability

Refer to Application Data Section for Additional Data

- The basic explosion-proof motor is Underwriters Laboratories, Inc. listed for service in hazardous locations indicated by the following table.
- The basic motor is either TENV or TEFC as noted on the rating page.
- A price addition must be made to obtain TEAO construction. (Refer to Modification Section)

Classification	Temp Code ¹	Frame	TENV	TEFC	TEAO In-Line	TEAO Piggy Back
CL. I GR. C & D	T4A-120° C	XC180ATY ³	Yes	Yes	Yes	Yes
		XC250ATY				
CL. II GR. E	T3B-165° C	XC180ATY ³	Yes	Yes	No	No
		XC250ATY				
CL. II GR. F & G	T3B-165° C	XC180ATY ³	Yes	Yes	Yes	No
		XC250ATY				
CL. I GR. C & D	T4-135° C	XC328ATZ ³	Yes	Yes	Yes	Yes
		XC3210ATZ				
CL. II GR. E	T3B-165° C	XC328ATZ ³	Yes	Yes	No	No
		XC3210ATZ				
CL. II GR. F & G	T3B-165° C	XC328ATZ ³	Yes	Yes	Yes	No
		XC3210ATZ				

¹ Temperature code applies for motors with required thermostats

Notes: ¹⁹ Motors rated 1150 rpm and 1750 rpm are suitable for use on Power Supply without the use of external reactors or chokes. Power supplies without the free wheeling diode may require an external choke.

Multiplier Symbol: N2

Totally Enclosed Explosion Proof

- 240 Armature
- 150V or 240V Field
- Power Code C ²⁰
- 40°C Ambient
- 1.0 Service Factor
- Straight Shunt Wound Fields
- Thermostat

Features

- Continuous Duty
- Class F Insulation

DC Motors 1 - 5 Hp

Hp	Class I Group C & D, Class II Group E, F & G				
	Base Speed RPM	Nominal By Field Control	TEFC Frame	Nominal By Field Control	TENV Frame
1	1750	2050	XC1811ATY	2100	XC1811ATY
	1150	1750	XC1811ATY	1750	XC1811ATY
1.5	2500	2750	XC1811ATY	2875	XC1811ATY
	1750	2050	XC1811ATY	2190	XC1811ATY
	1150	1380	XC1811ATY	1750	XC1811ATY
2	2500	2875	XC1811ATY	2875	XC1811ATY
	1750	2190	XC1811ATY	2190	XC1811ATY
	1150	1750	XC1811ATY	1750	XC1812TY
3	2500	2875	XC1811ATY	2875	XC1812ATY
	1750	2190	XC1812ATY	2190	XC1812ATY
	1150	1750	XC1812ATY	1380	XC257ATY
5	2500	2875	XC1812ATY	2875	XC257ATY
	1750	2050	XC257ATY	2190	XC257ATY
	1150	1380	XC258ATY	2000	XC258ATY
	850	1020	XC259ATY	1750	XC259ATY

Notes: ² Refer to a local ABB Sales Office for frame size

²⁰ Motors rated 1750 rpm and 1150 rpm base speed at 3/4 through 40Hp will operate on Power Code 0 without external choke or reactor.

Other ratings may require choke on Power Code D.

²¹ Class II, Group G is Class B Rise.

²² Will be labeled Class I, Group D and Class II, Group E, F & G

²³ Limited to Class I, Group D only

Multiplier Symbol: N2

Totally Enclosed Explosion Proof

- 240V Armature
 - 150V or 240V Field
 - Power Code C ²⁰
 - 500V Armature
 - 240V or 300V Field
 - Power Code C ²⁰
 - 1.0 Service Factor
 - Straight Shunt Wound Fields
 - Thermostat
 - Class 8 or F Rise ²¹
- Features**
- Continuous Duty
 - Class F Insulation
 - 40°C Ambient

DC Motors 7.5 - 200 Hp

Hp	Base Speed RPM	Nominal By Field Control	Class I Group C & D, Class II Group E & F		Class II, Group G (22)	
			240 Volt TEFC-XP Frame	500 Volt TEFC-XP Frame	240 Volt TEFC-XP Frame	500 Volt TEFC-XP Frame
7.5	2500	2950	XC257ATY	XC257ATY	XC257ATY	XC257ATY
	1750	1850	XC257ATY	XC257ATY	XC257ATY	XC257ATY
	1150	2000	XC257ATY	XC257ATY	XC259ATY	XC259ATY
	850	1020	XC259ATY	XC259ATY	XC328ATZ	XC328ATZ
10	2500	2700	XC257ATY	XC257ATY	XC257ATY	XC257ATY
	1750	1950	XC257ATY	XC257ATY	XC257ATY	XC257ATY
	1150	1380	XC258ATY	XC258ATY	XC328ATZ	XC328ATZ
	850	1020	XC328ATZ	XC328ATZ	XC3210ATZ	XC328ATZ
15	2500	2875	XC257ATY	XC257ATY	XC258ATY	XC258ATY
	1750	1950	XC257ATY	XC257ATY	XC259ATY	XC259ATY
	1150	1380	XC328ATZ	XC328ATZ	XC328ATZ	XC328ATZ
	850	1020	XC3210ATZ	XC3210ATZ	N/A	N/A
20	2500	2875	XC257ATY	XC257ATY	XC259ATY	XC258ATY
	1750	1950	XC259ATY	XC259ATY	XC328ATZ	XC3210ATZ
	1150	1380	XC328ATZ	XC328ATZ	N/A	XC3210ATZ
25	2500	2875	XC328ATZ	XC259ATY	XC328ATZ	XC328ATZ
	1750	1950	XC328ATZ	XC328ATZ	XC328ATZ	XC3210ATZ
	1150	1380	XC3210ATZ	XC3210ATZ	N/A	N/A
30	2500	2875	XC328ATZ	XC328ATZ	N/A	N/A
	1750	1950	XC328ATZ	XC3210ATZ	N/A	N/A
40	2500	2875	XC3210ATZ	XC3210ATZ	N/A	N/A

Notes: ²⁰ Motors rated 1750 rpm and 1150 rpm base speed at 3/4 through 40Hp will operate on Power Code 0 without external choke or reactor. Other ratings may require choke on Power Code D.

²¹ Class II, Group G is Class B Rise.

²² Will be labeled Class I, Group D and Class II, Group E, F & G

²³ Limited to Class I, Group D only

² Refer to a local ABB Sales Office for frame size

Multiplier Symbol: N2

Paper Mill Service Motors

Definite purpose motors designed for paper mill and other severe industrial applications as listed on the following pages are available with a choice of enclosures and temperature rise. Ratings are listed in either separately-ventilated enclosures with the required cooling air supplied by the customer or with an integral motor mounted blower driven by a three-phase motor.

Both Class F and Class B temperature rise ratings are listed to permit the customer to select the temperature rise of his choice. Class F temperature rise motors are rated 1.0 service factor. Class B temperature rise motors are rated 1.0 service factor at Class B rise and 1.15 service factor at Class F rise. The Class B rise motors are suitable for 200% load for one minute at base speed and below.

Certain modifications commonly required for these applications are noted on the basic rating pages. These modifications include Paper Mill Duty Features which is similar to XT features except applicable to motors not totally enclosed, Splashproof Covers, Transparent Handhole Covers, Shaft Grounding Brush and Thermostat.

Note: Location of transparent handhole covers must be specified on sales order.

Additional modifications as required for the application may be priced from the Modification Section.

Features:

- Class F Rise Ratings
 - 1.0 Service Factor at Class F Rise
 - 150% Load for One Minute
- Class B Rise Ratings
 - 1.0 Service Factor at Class B Rise
 - 1.15 Service Factor at Class F Rise
 - 200% Load for One Minute at Base Speed and Below
- Both Class F Rise Ratings and Class B Rise Ratings
 - Continuous Duty
 - 40° C Ambient
 - 240 V or 300 V Field (Specify field voltage)
 - Paper Mill Duty Features
 - Shaft Grounding Brush
 - Splashproof Covers
 - Transparent Handhole Covers
 - Thermostat

Refer to General Information Section For additional basic motor features.

Frame B845AT rated 400 Hp 300/1200 rpm driving paper machine winder



Paper Mill Service Motors

Splash-Proof Guarded Separately Ventilated ²⁹

- 240V Armature
- 240V or 300V Field
- Power Code C

Features

- Class F Rise Ratings
 - 1.0 Service Factor
 - 150% Load for One Minute
- Class B Rise Ratings
 - 1.0 Service Factor at Class B Rise
 - 1.15 Service Factor at Class F Rise
 - 200% Load for One Minute at Base Speed and Below

- Continuous Duty
- 40°C Ambient

Make list price additions from the Modification section for the following features required for Paper Mill Service.

- Paper Mill Duty Features
- Shaft Grounding Brush
- Splashproof Covers
- Transparent Handhole Covers
- Thermostats

DC Motors 7.5 - 250 Hp

Hp	Base Speed RPM	Nominal By Field Control	Temperature Rise	
			Class F Frame	Class B Frame
7.5	3500	3500	C1811ATZ	C1811ATZ
	2500	2875	C1811ATZ	C1811ATZ
	1750	1950	C1811ATZ	C1812ATZ
	1150	1380	C1812ATZ	SC2113ATZ
	850	1020	SC2113ATZ	SC2113ATZ
	650	1000	SC2113ATZ	MC2113ATZ
	500	750	LC2113ATZ	MC2115ATZ
	400	600	MC2115ATZ	LC2115ATZ
	300	450	LC2115ATZ	LC2512ATZ
10	3500	3500	C1811ATZ	C1812ATZ
	2500	2875	C1811ATZ	C1812ATZ
	1750	1950	C1812ATZ	SC2113ATZ
	1150	1380	SC2113ATZ	MC2113ATZ
	850	1020	SC2113ATZ	LC2113ATZ
	650	1000	MC2115ATZ	LC2115ATZ
	500	750	MC2115ATZ	LC2115ATZ
	400	600	MC2512ATZ	C2514ATZ
	300	450	LC2512ATZ	LC2812ATZ
15	3500	3500	C1812ATZ	SC2113ATZ
	2500	2875	C1812ATZ	SC2113ATZ
	1750	1950	SC2113ATZ	SC2113ATZ
	1150	1380	MC2113ATZ	LC2113ATZ
	850	1020	LC2113ATZ	MC2115ATZ
	650	1000	LC2115ATZ	LC2512ATZ
	500	750	LC2512ATZ	C2514ATZ
	400	600	C2514ATZ	C2515ATZ
	300	450	LC2812ATZ	C2815ATZ
20	3500	3500	SC2113ATZ	SC2113ATZ
	2500	2875	SC2113ATZ	SC2113ATZ
	1750	1950	SC2113ATZ	MC2113ATZ
	1150	1380	LC2113ATZ	MC2115ATZ
	850	1020	LC2115ATZ	MC2512ATZ
	650	1000	LC2115ATZ	MC2512ATZ

Hp	Base Speed RPM	Nominal By Field Control	Temperature Rise	
			Class F Frame	Class B Frame
20	650	1000	LC2512ATZ	C2514ATZ
	500	750	C2514ATZ	C2514ATZ
	400	600	LC2812ATZ	C2815ATZ
	300	450	C2815ATZ	LC3212ATZ
25	3500	3500	SC2113ATZ	SC2113ATZ
	2500	2875	SC2113ATZ	SC2113ATZ
	1750	1950	MC2113ATZ	LC2113ATZ
	1150	1380	MC2115ATZ	LC2115ATZ
	850	1020	MC2512ATZ	LC2512ATZ
	650	1000	C2514ATZ	C2515ATZ
30	500	750	LC2812ATZ	C2815ATZ
	400	600	C2815ATZ	LC3212ATZ
	300	450	C3214ATZ	MC3612ATZ
	3500	3500	SC2113ATZ	LC2113ATZ
40	2500	2875	SC2113ATZ	LC2113ATZ
	1750	1950	LC2113ATZ	MC2115ATZ
	1150	1380	LC2115ATZ	LC2512ATZ
	850	1020	LC2512ATZ	MC2812ATZ
	650	1000	C2515ATZ	C2515ATZ
	500	750	C2815ATZ	C2815ATZ
40	400	600	C2815ATZ	C3214ATZ
	300	450	C3214ATZ	C3613ATZ
	3500	3500	LC2113ATZ	LC2113ATZ
	2500	2875	LC2113ATZ	SC2512ATZ
	1750	1950	MC2115ATZ	LC2115ATZ
	1150	1380	LC2512ATZ	MC2812ATZ
40	850	1020	C2514ATZ	C2515ATZ
	650	1000	C2515ATZ	C2815ATZ
	500	750	C2815ATZ	C2815ATZ
	400	600	C3214ATZ	LC3612ATZ
	300	450	C3613ATZ	
	300	450	C3613ATZ	²

Notes: See page 64 for notes.
Multiplier Symbol: N2

DC Motors 7.5 - 250 Hp (continued)

Hp	Base Speed RPM	Nominal By Field Control	Temperature Rise		Hp	Base Speed RPM	Nominal By Field Control	Temperature Rise				
			Class F Frame	Class B Frame				Class F Frame	Class B Frame			
50	3500	3500	MC2115ATZ	MC2115ATZ	125	3500	3500	MC3212ATZ	LC3212ATZ			
	2500	2875	LC2115ATZ	LC2115ATZ		2500	2500	LC2812ATZ	LC3212ATZ			
	1750	1950	LC2115ATZ	LC2512ATZ		1750	2000	C2813ATZ	LC3212ATZ			
	1150	1380	C2514ATZ	C2515ATZ		1150	1380	C3214ATZ	LC3612ATZ			
	850	1020	C2515ATZ	C2815ATZ		850	1020	LC3612ATZ	C4011ATZ			
	650	1000	C2815ATZ	C3214ATZ		650	1000	MC4013ATZ	LC4013ATZ			
	500	750	C3214ATZ	LC3612ATZ		500	1350	LC4013ATZ	N/A			
	400	600	LC3612ATZ	C3613ATZ		400	1050	C4413ATZ	N/A			
	300	450	C3613ATZ	²		300	900	C4414ATZ	N/A			
	60	3500	3500	MC2115ATZ		MC2512ATZ	150	2500	2875	LC3212ATZ	MC3612ATZ	
2500		2875	LC2115ATZ	LC2512ATZ	1750	2000		C2815ATZ	C3214ATZ			
1750		1950	LC2512ATZ	C2514ATZ	1150	1380		C3613ATZ	C3613ATZ			
1150		1380	C2515ATZ	C2815ATZ	850	1020		C3613ATZ	MC4013ATZ			
850		1020	C2815ATZ	C2815ATZ	650	975		MC4013ATZ	LC4013ATZ			
650		1000	C3214ATZ	LC3612ATZ	500	1150		C4412ATZ	N/A			
500		750	LC3612ATZ	C4011ATZ	400	925		(2)	N/A			
400		600	C3613ATZ	MC4013ATZ	2500	2875		C3214ATZ	C3214ATZ			
300		450	LC4013ATZ	²	1750	1900		C3214ATZ	LC3612ATZ			
75		3500	3500	MC2512ATZ	LC2512ATZ	200		1150	1380	C3613ATZ	C3613ATZ	
	2500	2875	LC2512ATZ	MC2812ATZ	850		1020	MC4013ATZ	LC4013ATZ			
	1750	1950	C2514ATZ	C2515ATZ	650		1600	C4413ATZ	C4414ATZ			
	1150	1380	C2815ATZ	C2815ATZ	500		1300	C4414ATZ	N/A			
	850	1020	C2815ATZ	C3214ATZ	1750		1750	LC3612ATZ	C4011ATZ			
	650	1000	LC3612ATZ	LC3612ATZ	1150		1380	MC4013ATZ	LC4013ATZ			
	500	750	MC4013ATZ	MC4013ATZ	850		1020	LC4013ATZ	N/A			
	400	600	MC4013ATZ	N/A	650		1350	C4413ATZ	N/A			
	300	450	C4414ATZ	N/A	250							
	100	3500	3500	²						MC2812ATZ		
2500		2500	MC2812ATZ	MC2812ATZ								
1750		2000	C2515ATZ	C2813ATZ								
1150		1380	C2815ATZ	MC3612ATZ								
850		1020	C3214ATZ	LC3612ATZ								
650		1000	C3613ATZ	MC4013ATZ								
500		750	MC4013ATZ	N/A								
400		1200	C4413ATZ	N/A								
300		900	C4414ATZ	N/A								

Notes: ² Refer to a local ABB Sales Office for frame size.

⁶ Motor speed under any condition must not exceed maximum safe speed on nameplate.

⁷ Motor must be speed regulated and/or speed limit switch must be included to limit speed on winder duty.

Motor speed under any condition must not exceed maximum safe speed listed in on nameplate.

²⁹ Enclosure is Splash-Proof Guarded, Separately-Ventilated (SPG-SV). Motor must have cooling air supplied when field are excited at rated voltage.

³⁰ Percentage Addition to either Class F or Class B List price applies to either Continuous Duty maximum Field Weakened Speed or Winder Duty Maximum Field Weakened Speed.

³¹ Armature voltage is 600 V

³² Enclosure is Splash-Proof Guarded, Force-Ventilated (SPG-FV). Motor mounted blower(s) without filter with motor(s) for 3-phase 50/60 Hz, 230/460 AC power supply is included in list price. Motor must have cooling air supplied when fields are excited at rated voltage.

Multiplier Symbol: N2

Paper Mill Service Motors

Splash-Proof Guarded Separately Ventilated ²⁹

- 500V Armature
- 240V or 300V Field
- Power Code C

Features

- Class F Rise Ratings
 - 1.0 Service Factor
 - 150% Load for One Minute
- Class B Rise Ratings
 - 1.0 Service Factor at Class B Rise
 - 1.15 Service Factor at Class F Rise
 - 200% Load for One Minute at Base Speed and Below

- Continuous Duty
- 40°C Ambient

Make list price additions from the Modification section for the following features required for Paper Mill Service.

- Paper Mill Duty Features
- Shaft Grounding Brush
- Splashproof Covers
- Transparent Handhole Covers
- Thermostats

DC Motors 300 - 500 Hp

Hp	Base Speed RPM	Nominal Field Weakening Speed - RPM		Temperature Rise		Extended Field Range						Percentage Addition to Basic Motor Price for Maximum Field Weakened Speed
						Continuous Duty			Winder Duty			
		Non- Reversing Duty	Reversing Duty	Class F Frame	Class B Frame	Non- Reversing Duty	Reversing Duty	Maximum Field Weakening Speed - RPM				
								Class F	Class B	Class F	Class B	
300	1750	1900	1900	LC3613ATZ	MC4013ATZ	2300	2200	2300	1980	-	2200	10
	1150	1600	1600	LC4013ATZ	C4413ATZ	2000	2100	2000	2100	-	-	-
	850	1300	1300	C4413ATZ	C4414ATZ	1900	1500	1900	1500	2200	1900	10
400	1750	1900	1900	MC4013ATZ	C4412ATZ	-	2200	-	2200	-	-	10
	1150	1200	1200	C4413ATZ	C4414ATZ	1600	1650	1600	1650	-	-	10
	850	1000	1000	C4414ATZ	-	1300	-	1300	-	-	-	10
500	1750	1750	1750	C4412ATZ	-	2000	-	2000	-	-	-	10
	1150	1200	1200	C4414ATZ	-	1450	-	1450	-	-	-	10

Notes: ² Refer to a local ABB Sales Office for frame size.

⁶ Motor speed under any condition must not exceed maximum safe speed on nameplate.

⁷ Motor must be speed regulated and/or speed limit switch must be included to limit speed on winder duty.

Motor speed under any condition must not exceed maximum safe speed listed in on nameplate.

²⁹ Enclosure is Splash-Proof Guarded, Separately-Ventilated (SPG-SV). Motor must have cooling air supplied when field are excited at rated voltage.

³⁰ Percentage Addition to either Class F or Class B List price applies to either Continuous

Duty maximum Field Weakened Speed or Winder Duty Maximum Field Weakened Speed.

³¹ Armature voltage is 600 V

³² Enclosure is Splash-Proof Guarded, Force-Ventilated (SPG-FV). Motor mounted blower(s) without filter with motor(s) for 3-phase 50/60 Hz, 230/460 AC power supply is included in list price. Motor must have cooling air supplied when fields are excited at rated voltage.

Multiplier Symbol: N2

Paper Mill Service Motors

Splash-Proof Force Ventilated with Motor Mounted Blower ³²

- 500V Armature
- 40V or 300V Field
- Power Code C

Features

- Class F Rise Ratings
 - 1.0 Service Factor
 - 150% Load for One Minute
- Class B Rise Ratings
 - 1.0 Service Factor at Class B Rise
 - 1.15 Service Factor at Class F Rise
 - 200% Load for One Minute at Base Speed and Below

- Continuous Duty
- 40°C Ambient

Make list price additions from the Modification section for the following features required for Paper Mill Service.

- Paper Mill Duty Features
- Shaft Grounding Brush
- Splashproof Covers
- Transparent Handhole Covers
- Thermostats

DC Motors 7.5 - 250 Hp

Hp	Base Speed RPM	Nominal By Field Control	Temperature Rise	
			Class F Frame	Class B Frame
7.5	3500	3500	C1811ATZ	C1811ATZ
	2500	2875	C1811ATZ	C1811ATZ
	1750	1950	C1811ATZ	C1812ATZ
	1150	1380	C1812ATZ	SC2113ATZ
	850	1020	SC2113ATZ	SC2113ATZ
	650	1000	SC2113ATZ	MC2113ATZ
	500	750	LC2113ATZ	MC2115ATZ
	400	600	MC2115ATZ	LC2115ATZ
	300	450	LC2115ATZ	LC2512ATZ
10	3500	3500	C1811ATZ	C1812ATZ
	2500	2875	C1811ATZ	C1812ATZ
	1750	1950	C1812ATZ	SC2113ATZ
	1150	1380	SC2113ATZ	MC2113ATZ
	850	1020	SC2113ATZ	LC2113ATZ
	650	1000	MC2115ATZ	LC2115ATZ
	500	750	MC2115ATZ	LC2115ATZ
	400	600	MC2512ATZ	C2514ATZ
	300	450	LC2512ATZ	LC2812ATZ
15	3500	3500	C1812ATZ	SC2113ATZ
	2500	2875	C1812ATZ	SC2113ATZ
	1750	1950	SC2113ATZ	SC2113ATZ
	1150	1380	MC2113ATZ	LC2113ATZ
	850	1020	LC2113ATZ	MC2115ATZ
	650	1000	LC2115ATZ	LC2512ATZ
	500	750	LC2512ATZ	C2514ATZ
	400	600	C2514ATZ	C2515ATZ
	300	450	LC2812ATZ	C2815ATZ
20	3500	3500	SC2113ATZ	SC2113ATZ
	2500	2875	SC2113ATZ	SC2113ATZ
	1750	1950	SC2113ATZ	MC2113ATZ
	1150	1380	LC2113ATZ	MC2115ATZ
	850	1020	LC2115ATZ	MC2512ATZ
	650	1000	LC2115ATZ	MC2512ATZ

Hp	Base Speed RPM	Nominal By Field Control	Temperature Rise	
			Class F Frame	Class B Frame
20 Cont.	650	1000	LC2512ATZ	C2514ATZ
	500	750	C2514ATZ	C2514ATZ
	400	600	LC2812ATZ	C2815ATZ
	300	450	C2815ATZ	LC3212ATZ
25	3500	3500	SC2113ATZ	SC2113ATZ
	2500	2875	SC2113ATZ	SC2113ATZ
	1750	1950	MC2113ATZ	LC2113ATZ
	1150	1380	MC2115ATZ	LC2115ATZ
	850	1020	MC2512ATZ	LC2512ATZ
	650	1000	C2514ATZ	C2515ATZ
30	500	750	LC2812ATZ	C2815ATZ
	400	600	C2815ATZ	LC3212ATZ
	300	450	C3214ATZ	MC3612ATZ
	3500	3500	SC2113ATZ	LC2113ATZ
	2500	2875	SC2113ATZ	LC2113ATZ
	1750	1950	LC2113ATZ	MC2115ATZ
40	1150	1380	LC2115ATZ	LC2512ATZ
	850	1020	LC2512ATZ	MC2812ATZ
	650	1000	C2515ATZ	C2515ATZ
	500	750	C2815ATZ	C2815ATZ
	400	600	C2815ATZ	C3214ATZ
	300	450	C3214ATZ	C3613ATZ
40	3500	3500	LC2113ATZ	LC2113ATZ
	2500	2875	LC2113ATZ	SC2512ATZ
	1750	1950	MC2115ATZ	LC2115ATZ
	1150	1380	LC2512ATZ	MC2812ATZ
	850	1020	C2514ATZ	C2515ATZ
	650	1000	C2515ATZ	C2815ATZ
	500	750	C2815ATZ	C2815ATZ
	400	600	C3214ATZ	LC3612ATZ
	300	450	C3613ATZ	²

Notes: See page 64 for notes.
Multiplier Symbol: N2

DC Motors 7.5 - 250 Hp (continued)

Hp	Base Speed RPM	Nominal By Field Control	Temperature Rise	
			Class F Frame	Class B Frame
50	3500	3500	MC2115ATZ	MC2115ATZ
	2500	2875	LC2115ATZ	LC2115ATZ
	1750	1950	LC2115ATZ	LC2512ATZ
	1150	1380	C2514ATZ	C2515ATZ
	850	1020	C2515ATZ	C2815ATZ
	650	1000	C2815ATZ	C3214ATZ
	500	750	C3214ATZ	LC3612ATZ
	400	600	LC3612ATZ	C3613ATZ
	300	450	C3613ATZ	²
60	3500	3500	MC2115ATZ	MC2512ATZ
	2500	2875	LC2115ATZ	LC2512ATZ
	1750	1950	LC2512ATZ	C2514ATZ
	1150	1380	C2515ATZ	C2815ATZ
	850	1020	C2815ATZ	C2815ATZ
	650	1000	C3214ATZ	LC3612ATZ
	500	750	LC3612ATZ	C4011ATZ
	400	600	C3613ATZ	MC4013ATZ
	300	450	LC4013ATZ	²
75	3500	3500	MC2512ATZ	LC2512ATZ
	2500	2875	LC2512ATZ	MC2812ATZ
	1750	1950	C2514ATZ	C2515ATZ
	1150	1380	C2815ATZ	C2815ATZ
	850	1020	C2815ATZ	C3214ATZ
	650	1000	LC3612ATZ	LC3612ATZ
	500	750	MC4013ATZ	MC4013ATZ
	400	600	MC4013ATZ	N/A
	300	450	C4414ATZ	N/A
100	3500	3500	²	MC2812ATZ
	2500	2500	MC2812ATZ	MC2812ATZ
	1750	2000	C2515ATZ	C2813ATZ
	1150	1380	C2815ATZ	MC3612ATZ
	850	1020	C3214ATZ	LC3612ATZ
	650	1000	C3613ATZ	MC4013ATZ
	500	750	MC4013ATZ	N/A
	400	1200	C4413ATZ	N/A
	300	900	C4414ATZ	N/A

Hp	Base Speed RPM	Nominal By Field Control	Temperature Rise	
			Class F Frame	Class B Frame
125	3500	3500	MC3212ATZ	LC3212ATZ
	2500	2500	LC2812ATZ	LC3212ATZ
	1750	2000	C2813ATZ	LC3212ATZ
	1150	1380	C3214ATZ	LC3612ATZ
	850	1020	LC3612ATZ	C4011ATZ
	650	1000	MC4013ATZ	LC4013ATZ
	500	1350	LC4013ATZ	N/A
	400	1050	C4413ATZ	N/A
	300	900	C4414ATZ	N/A
150	2500	2875	LC3212ATZ	MC3612ATZ
	1750	2000	C2815ATZ	C3214ATZ
	1150	1380	C3613ATZ	C3613ATZ
	850	1020	C3613ATZ	MC4013ATZ
	650	975	MC4013ATZ	LC4013ATZ
	500	1150	C4412ATZ	N/A
	400	925	²	N/A
200	2500	2875	C3214ATZ	C3214ATZ
	1750	1900	C3214ATZ	LC3612ATZ
	1150	1380	C3613ATZ	C3613ATZ
	850	1020	MC4013ATZ	LC4013ATZ
	500	1300	C4414ATZ	N/A
250	1750	1750	LC3612ATZ	C4011ATZ
	1150	1380	MC4013ATZ	LC4013ATZ
	850	1020	LC4013ATZ	N/A
	650	1350	C4413ATZ	N/A

Notes: ² Refer to a local ABB Sales Office for frame size.

⁶ Motor speed under any condition must not exceed maximum safe speed on nameplate.

⁷ Motor must be speed regulated and/or speed limit switch must be included to limit speed on winder duty.

Motor speed under any condition must not exceed maximum safe speed listed in on nameplate.

²⁹ Enclosure is Splash-Proof Guarded, Separately-Ventilated (SPG-SV). Motor must have cooling air supplied when field are excited at rated voltage.

³⁰ Percentage Addition to either Class F or Class B List price applies to either Continuous Duty maximum Field Weakened Speed or Winder Duty Maximum Field Weakened Speed.

³¹ Armature voltage is 600 V

³² Enclosure is Splash-Proof Guarded, Force-Ventilated (SPG-FV). Motor mounted blower(s) without filter with motor(s) for 3-phase 50/60 Hz, 230/460 AC power supply is included in list price. Frames C4414ATZ and smaller have one blower motor. Motor must have cooling air supplied when fields are excited at rated voltage.

Multiplier Symbol: N2

Paper Mill Service Motors

Splash-Proof Force Ventilated with Motor Mounted Blower ³²

- 500V Armature
- 240V or 300V Field
- Power Code C

Features

- Class F Rise Ratings
 - 1.0 Service Factor
 - 150% Load for One Minute
- Class B Rise Ratings
 - 1.0 Service Factor at Class B Rise
 - 1.15 Service Factor at Class F Rise
 - 200% Load for One Minute at Base Speed and Below

- Continuous Duty
- 40°C Ambient

Make list price additions from the Modification section for the following features required for Paper Mill Service.

- Paper Mill Duty Features
- Shaft Grounding Brush
- Splashproof Covers
- Transparent Handhole Covers
- Thermostats

DC Motors 300 - 500 Hp

Hp	Base Speed RPM	Nominal Field Weakening Speed - RPM		Temperature Rise		Extended Field Range						Percentage Addition to Basic Motor Price for Maximum Field Weakened Speed
						Continuous Duty			Winder Duty			
		Non- Reversing Duty	Reversing Duty	Class F Frame	Class B Frame	Non- Reversing Duty	Reversing Duty		Maximum Field Weakening Speed - RPM			
							Class F	Class B	Class F	Class B		
300	1750	1900	1900	LC3613ATZ	MC4013ATZ	2300	2200	2300	1980	-	2200	10
	1150	1600	1600	LC4013ATZ	C4413ATZ	2000	2100	2000	2100	-	-	-
	850	1300	1300	C4413ATZ	C4414ATZ	1900	1500	1900	1500	2200	1900	10
400	1750	1900	1900	MC4013ATZ	C4412ATZ	-	2200	-	2200	-	-	10
	1150	1200	1200	C4413ATZ	C4414ATZ	1600	1650	1600	1650	-	-	10
	850	1000	1000	C4414ATZ	-	1300	-	1300	-	-	-	10
500	1750	1750	1750	C4412ATZ	-	2000	-	2000	-	-	-	10
	1150	1200	1200	C4414ATZ	-	1450	-	1450	-	-	-	10

Notes: ³¹ Armature voltage is 600 V
Multiplier Symbol: N2

Range Drive Motors

Splash-Proof Guarded

- 240V Armature
 - 240V Field
 - Power Code C
 - Provision for Adding Flange Mounted Tachometer
 - F1 Mounting
- Range drive motors have matched IR drops within approximately 5 volts .and good regulation characteristics out to the maximum field weakened speed of 2300 rpm.
 - Capable of operation at 25% base speed with 67% armature current and motor field pre-weakened to 2100 rpm.
- Specially designed for use on multi-motor drives operating on a common voltage power supply such as textile range drives, roofing machines, tube mills, etc.

Features

- Continuous Duty
- Class F Insulation
- 40°C Ambient
- 1.0 Service Factor
- Stabilized Shunt Wound Fields
- Thermostat

DC Motors 3 - 50 Hp

Hp	Base Speed RPM	Maximum Field Weakened Speed RPM	Frame	Electrical Design Number	Mounting	Model Number
3	1750	2300	C1811ATCZ	G2001C ³³	180T C-Face/Foot	T18R1009
5	1750	2300	C1811ATCZ	G2002C ³³	180T C-Face/Foot	T18R1010
7.5	1750	2300	C1812ATCZ	G2003C ³³	180T C-Face/Foot	T18R1011
10	1750	2300	SC2113ATCZ	G6190A ³³	210T C-Face/Foot	T21S1001
15	1750	2300	LC2113ATCZ	G6191AA ³³	250T C-Face/Foot	T21S1002
20	1750	2300	LC2113ATCZ	G6068BA	250T C-Face/Foot	T21S1003
25	1750	2300	SC2512ATCZ	G6237AB ³³	250T C-Face/Foot	T25S1001
30	1750	2300	MC2512ATCZ	G6411AA ³³	Foot	T25S101
40	1750	2300	LC2512ATZ	G6410AA	Foot	T25S102
50	1750	2300	MC2812ATZ	G6407AA	Foot	T28S101

Notes: ³³ Suitable for Power Code D
Multiplier Symbol: N2

Extruder Duty Motors

Drip-Proof Guarded Force-Ventilated ⁽¹¹⁾(36)

Complete with Motor Mounted Blower and Filter

- 240V Armature
- 150V or 240V Field
- Power Code C
- 500V Armature
- 240V or 300V Field
- Power Code C

Features

- Continuous Duty
- 40°C Ambient
- 1.0 Service Factor
- Stabilized Shunt Wound Fields
- Enclosed Commutator Design

Make list price additions from the Modification section for the following features required for Extruder Duty Design.

- Fiberglass Replaceable Filter
- Transparent Hand Hole Cover
- Warning Thermostat
- High Limit Thermostat

DC Motors 10 - 400 Hp

Hp	Speed RPM		DPG-FV Frame	
	Base Speed	Nominal By Field Control	240 Volts	500 Volts
10	2500	2875	SC2113ATZ	SC2113TZ
	1750	1950	SC2113ATZ	SC2113TZ
	1150	1380	MC2113ATZ	MC2113ATZ
	850	1020	LC2113ATZ	LC2113ATZ
15	2500	2875	SC2113ATZ	SC2113ATZ
	1750	1950	SC2113ATZ	SC2113ATZ
	1150	1380	LC2113ATZ	LC2113ATZ
20	850	1020	SC2512AZ	SC2512ATZ
	2500	2875	SC2113ATZ	SC2113ATZ
	1750	1950	MC2113ATZ	MC2113ATZ
	1150	1380	SC2512ATZ	SC2512ATZ
25	850	1020	MC2512ATZ	MC2512ATZ
	2500	2875	SC2113ATZ	MC2113ATZ
	1750	1950	LC2113ATZ	LC2113ATZ
	1150	1380	MC2512ATZ	MC2512ATZ
30	850	1020	LC2512ATZ	LC2512ATZ
	2500	2875	LC2113ATZ	LC2113ATZ
	1750	1950	SC2512ATZ	SC2512ATZ
	1150	1380	LC2512ATZ	LC2512ATZ
40	850	1020	LC2812ATZ	MC2812ATZ
	2500	2875	SC2512ATZ	SC2512ATZ
	1750	1950	MC2512ATZ	MC2512ATZ
	1150	1380	MC2812ATZ	MC2812ATZ
50	850	1020	MC3212ATZ	LC2812ATZ
	2500	2875	MC2512ATZ	MC2512ATZ
	1750	1950	LC2512ATZ	LC2512ATZ
	1150	1380	LC2812ATZ	LC2812ATZ
60	850	1020	MC3212ATZ	MC3212ATZ
	2500	2875	MC2812ATZ	LC2512ATZ
	1750	1950	LC2812ATZ	MC2812ATZ
	1150	1380	LC3212ATZ	MC3212ATZ
	850	1020	LC3212ATZ	LC3212ATZ

Hp	Speed RPM		DPG-FV Frame	
	Base Speed	Nominal By Field Control	240 Volts	500 Volts
75	2500	2875	LC2812ATZ	MC2812ATZ
	1750	1950	LC2812ATZ	LC2812ATZ
	1150	1380	LLC3212ATZ	LC3212ATZ
100	850	1020	LC3612ATZ	LC3612ATZ
	2500	2875	²	C2813ATZ
	1750	1950	²	MC3212ATZ
	1150	1380	²	MC3612ATZ
125	850	1020	²	LC3612ATZ
	2500	2875	²	LC3212ATZ
	1750	1950	²	LC3212ATZ
	1150	1380	²	LC3612ATZ
150	850	1020	²	C4011ATZ
	2500	2875	²	MC3612ATZ
	1750	1950	²	MC3612ATZ
	1150	1380	²	C4011ATZ
200	850	1020	²	MC4013ATZ
	2500	2875	²	MC3612ATZ
	1750	1950	²	LC3612ATZ
	1150	1380	²	MC4013ATZ
250	850	1020	²	LC4013ATZ
	2500	2875	²	LLC3612ATZ
	1750	1950	²	C4011ATZ
300	1750	1950	²	MC4013ATZ
400	1750	1950	²	LC4013ATZ

Notes: ² Refer to a local ABB Sales Office for frame size.
Multiplier Symbol: N2

IEC DC Motors

Complete with Motor Mounted Blower

Features

- 460V Armature, 310V Field
- S-1 Duty
- 40°C Ambient
- 1.0 Service Factor
- Class H Insulation
- Straight Shunt Wound
- Foot Mounted
- Thermistor
- Provision for Tachometer
- F-2 Mounting
- Power Code 6/6 - 415 - 50 - 0

DC Motors 15.9 - 396 kW

kW	Base Speed	Frame	Enclosure
15.9	1690	GK1303	IP23-IC06
17.6	1775	GK1305	IP23-IC06
16	1368	GK1305	IP23-IC06
24.7	1685	GK1307	IP23-IC06
31.9	1945	GK1309	IP23-IC06
21.5	1215	GK1309	IP23-IC06
42.4	1985	GK1311	IP23-IC06
36.9	1675	GK1311	IP23-IC06
47.9	1905	GK1606	IP23-IC06
31.7	1190	GK1606	IP23-IC06
60.3	1725	GK1608	IP23-IC06
49	1365	GK1608	IP23-IC06
41.3	1135	GK1608	IP23-IC06
80.9	1805	GK1610	IP23-IC06
59.7	1250	GK1610	IP23-IC06
99.3	2055	UGK1808 ³⁷	IP23-IC06
80.9	1615	UGK1808 ³⁷	IP23-IC06
113	1625	UGK1810 ³⁷	IP23-IC06
84.4	1200	UGK1810 ³⁷	IP23-IC06
177	2075	ULGK2008 ³⁷	IP23-IC06
141	1600	UGK2008 ³⁷	IP23-IC06
115	1265	UGK2008 ³⁷	IP23-IC06
103	1130	UGK2008 ³⁷	IP23-IC06
192	1965	ULGK2010 ³⁷	IP23-IC06
254	1825	ULGK2208 ³⁷	IP23-IC06
246	1670	ULGK2208 ³⁷	IP23-IC06
181	1195	ULGK2208 ³⁷	IP23-IC06
204	1210	ULGK2210 ³⁷	IP23-IC06
292	1660	GK2508	IP23-IC06
371	1640	GK2510	IP23-IC06
228	940	UGK2510 ³⁷	IP23-IC06
327	1210	GS2808	IP23-IC06
396	1150	GS2810	IP23-IC06

Notes: ³⁷ Roller bearing for belted duty only.
Multiplier Symbol: N2

Laminated Frame DC Modifications and Accessories

Modifications which can be manufactured as part of a custom motor design.

Table of contents

Air pressure switch	Speed limit switch
Altitude	Provisions for mounting only
Ambient temperature	Field windings
Balance, dynamic	Filters
Bases	Footless frame
Bearings & bearing modifications	Gearmotor provisions
Blowers	Insulation
Brackets	Leads
Brakes & brake modifications	Lead lugs
Brake limit switch	Lubrication grease
Brake mounting provision	Mounting of customer supplied equipment
Brush - special	Overload, special momentary
Bus bar terminations	Packaging
Conduit box	Paint
Covers	Service factor
Drain plugs	Shaft modifications
Enclosures	Space heaters
Enclosure enhancements- severe duty	Speed-base speed 3500 rpm
Feedback devices	Speed range
Coupled encoders	Technical data
Bearingless encoders	Tests
Explosion-proof encoders	Thermal protection
Resolvers	Vertical lifting
Tachometers	Voltage
	Warranty

Laminated Frame DC Modifications and Accessories

Air pressure switch

Switch

Standard Enclosure

Weatherproof Enclosure

Mounted on motor bracket at air inlet end or output side of the blower housing. Monitors pressure differential between inside and outside of motor or blower to actuate SPDT switch when pressure drops below preset value giving an immediate indication that the air supply to the motor is reduced. Applicable to forced ventilated motors with either motor mounted blower or separately forced ventilated by customer supplied air. Since motors dependent on force ventilation will have a rapid rise in temperature after the air supply is interrupted, the customer must take immediate corrective action when the switch trips. Contacts rated 15 amps, 120-480 volts, 60 Hz AC resistive; 1/8 Hp at 125 volts; 1/4 Hp at 250 volts, 60Hz AC. Applicable to frames C180ATZ through C4413ATZ.

Note: Use price for Weatherproof Enclosure switch when specifying an Explosion Proof switch on non -explosion proof motor.

Altitude

High Altitude

For motors and generators operating over 3,300 feet, refer to the derating chart in CA608D. Select the appropriate motor frame and rating based on this chart. Use this higher HP motor frame and list price.

Standard guarantees are made on the basis that the motor will operate at an altitude from sea level to 3300 feet per NEMA MG1-14.04. Applicable to all enclosures. Note: Frame may change.

Ambient temperature

High Ambient

For motors and generators operating over 40°C, refer to the derating chart in CA608D. Select the appropriate motor frame and rating based on this chart. Use this higher HP motor frame and list price.

For motors suitable for operation in ambients greater than 40° C. Note: Frame size may change.

Low Ambient

Ambient as low as -1 to -25°C

Special brushes provided as required.

Ambient as low as -40°C

Low temperature grease, special

Ambient as low as -60°C

Low temperature grease, special brushes, high tensile strength shaft material, special commutator and special fan on TEFC motors provided as required. Not available on explosion-proof motors.

Note: For DC Machines operating in low ambient conditions, the base speeds and regulation may not be in accordance with NEMA standards. Motors should have space heater added to prevent condensation of moisture when unenergized.

Balance, dynamic

Electric motor balance and vibration

Balance can be defined as the state of the mass distribution within the rotating assembly about its axis of rotation. The eccentricities of this mass distribution are referred to as unbalance. The amount of unbalance is stated in units of mass times a distance, such as gram-inches, gram-centimeters or gram-millimeters. Vibration is defined as the motion of a body in response to forces imposed upon that body. Vibration in assembled motors can be measured as amplitude in inches, peak-to-peak, or as velocity in inches per second or as velocity in millimeters per second.

- Displacement, inches, Peak to Peak = $19.10 \times \text{Velocity, Inches per Second, Peak} \div \text{RPM}$
- Displacement, Inches, Peak to Peak = $1.062 \times \text{Velocity, Millimeters per Second, RMS} \div \text{RPM}$
- Displacement, Inches, Peak to Peak = $0.752 \times \text{Velocity, Millimeters per Second, Peak} \div \text{RPM}$
- Velocity, in/sec peak = $\text{Displacement, inches peak} \times 2 \pi \times f \div 60$ or $\text{Displacement, in p-p} \times \pi \times f \div 60$
- RMS = Peak to Peak $\times 0.707$
- Peak = Peak to Peak $\times 0.50$ (f=rpm)

In addition to unbalance, there are other sources of motor vibration such as uneven air gap, frame distortion due to improper torquing of foot mounting bolts, operation at or near critical speed and various bearing, support, coupling and electromagnetic effect problems. Unbalance is the predominant component in vibration when displacement is measured. The many other, higher frequency components show up when measuring velocity.

Standards

Standard Baldor-Reliance motors are manufactured in accordance with the vibration limits stated in NEMA MG1, Part 7. Per NEMA, bearing housing vibration is stated as “the peak value of the unfiltered vibration velocity in inches per second”. Table I shows bearing housing vibration velocity in inches per second as well as other units for comparison. Shaft vibration measurements are recommended for sleeve bearing machines only. Contact a local ABB Sales Office when you have sleeve bearing requirements.

Table I - Standard Machine Vibration Limits

Vibration Category	Speed RPM	(New NEMA Standard) Unfiltered Vibration Velocity in /sec peak	Unfiltered Vibration Velocity mm / sec peak	(IEC Terminology) Unfiltered Vibration Velocity mm / sec rms	(Old NEMA Terminology) Amplituded Displacement Inch Peak to Peak
Standard	1801-3600	0.15	3.8	2.7	0.0008
	1201-1800	0.15	3.8	2.7	0.0016
	901-1200	0.15	3.8	2.7	0.0024
	721-900	0.12	3.0	2.1	0.0025
	601-720	0.09	2.3	1.6	0.0025
	Less than 600	0.08	2.0	1.4	0.0025

Table II - Special Machine Vibration Limits

Vibration Category	Speed RPM	Unfiltered Vibration Velocity in/sec peak
Ultra-Standard	1801-3600	0.10
	1201-1800	0.08
	Less than 1200	0.08
Precision	1801-3600	0.06
	1201-1800	0.04
	Less than 1200	0.04

Bases

Base Type	
Heavy Duty Base	Two adjusting bolts for adjusting belt tension. Not suitable for wall or ceiling mounting.
Adjustable B500ATZ Slide Rails B580ATZ	Not suitable for wall or ceiling mounting.
Adapter Rails Frames DC180ATZ - C4414	Provides adapter rails to permit using a current design motor with its small "D" dimension in the same location as a Super RPM, RPM, or Super T motor. The modification provides rails only and is normally used for coupled applications. Note that difference in shaft diameter and length will probably require a change in customer's coupling. Also allows using RPM III to replace old DC motors by other manufacturers.
Soleplates	Provides two steel plates for customer installation between motor and foundation.

Bearings & bearing modifications

Bearing modifications	
Insulated Bearings	Frame sizes C440ATZ come standard with an insulated bearing on the non-drive end.
Roller Bearings / Belted Drive	Roller Bearings (Belted Drive) — Provides for roller bearings and special shaft on frames UC180-C4414 used for belted drive. C180ATZ-C250ATZ frames are suitable for belted drive as standard. Refer to the Application Data Section for minimum sheave diameter and center-to-center distance. Details of the drive system must accompany the order. Belted drive applications not meeting the standard minimum sheave diameters, etc., require special pricing. Refer to Mounting of Customer Property for pricing to mount customer's finished bore sheave.
Grease Fittings	Alemite No. 1610 fittings to replace pipe plugs provided as standard. NOTE: Not available on DC180ATZ or DC2112ATZ frame - to obtain this modification on 180 frame, price a C180ATZ frame by using the 500 V armature basic motor price at same Hp and base speed.
Grease Relief Fittings	Two automatic grease relief fittings to replace standard pipe plugs. Note: Not available on DC180ATZ or DC2112ATZ frame. To obtain this modification on 180 frame, price C180ATZ frame by using the 500v armature basic motor price at same HP and base speed.

Blowers

Standard blower motor voltages included in the base price of a Force Ventilated enclosure are 3 phase 50/60 hertz 240/480 volts (230/460). For other voltages and frequencies or for 1 phase add the charge below.

Special. blower motor

Single Phase- 50 or 60 Hz

Three Phase - 50 or 60 Hz

Brackets

Bracket Type

C-Face

D-Flange

P-Base

NEMA AC C-Face or D-Flange bracket with standard dimensions. C-Face available on frames DC180ATCZ through C360ATCZ only. D-flange available on frames DC180ATDZ except D-flange not available on DC2112ATZ frame. Special seals required when oil will be around the shaft. Add modification for footless frame if desired. Vertical P-base available on frames C180ATZ-C440ATZ. Since there is not a NEMA standard for DC P-base motors, customer dimensions must be supplied with the order. An adaptor may be added to the D-flange to meet the desired P-base dimensions.

Note: NEMA defines different shaft dimensions for AC and DC C-face motors. Since standard C-face reducers require NEMA AC motor shaft dimensions, specify which NEMA AC motor C-face size when DC motor will be connected to a reducer. No special price addition other than this modification is required for NEMA AC C-face and shaft. Our standard is to be considered the AC C-face for that frame diameter.

IMPORTANT:

Motor C-Face is intended for mounting auxiliary equipment such as pumps, gears, etc. When mounted horizontally, frames C280ATCZ through C360ATCZ should be supported by the feet and not by the C-Face. Installations requiring a horizontally mounted motor without feet supported should use a D-flange bracket. (These D-flange frames require support by feet when mounted horizontal: C2515ATDZ, C2815ATDZ, C3214ATDZ, C3613ATDZ, and all D-flange C400, C440.)

Brakes & brake modifications

Motor Mounted Brakes (Disc Type) - These motor mounted brakes are continuously rated, non-adjustable, electrically released and spring set applicable for both holding and stopping service within the nominal torque ratings listed. Brakes used for frequently repeated stopping service or other severe applications may be limited by thermal capacity and should be referred to ABB.

- Motor mounting position, i.e., horizontal or vertical, shaft up, or down, or ceiling, must be specified on the order. For vertical mounting standard enclosures and dust tight / waterproof see adders below.
- Brakes can be mounted on all enclosures except TEAO-INLINE Blowers and TEFC C400ATZ Frames. Use TEAO Piggyback enclosure to mount brakes on C400ATZ.
- For some combinations of brake and motor, the brake may extend below the motor feet. Special motor mounting is required to provide clearance.
- Add space heater modification on brake when required.
- A manual release is included as standard on all brakes listed.
- Refer to ABB for separately mounted shoe brake, special brakes, and brakes of specific manufacturer. For higher speeds, contact ABB.

Brake limit switch

Indicates condition of brake. Specify if switch is to be OPEN or CLOSED when brake coil is energized.

Brake Torque

Single Phase- 50 or 60 Hz

750 - 1000 ft. -lbs

Brake mounting provision

Frame Size

Brake mounting provision	Provides flange and motor shaft extension on opposite drive end for customer mounting of brake through C4414ATZ frame.
--------------------------	--

Brush - special

Frame Size

Low Current Density	Special brush grade to allow motor to be operated below 50% of rated current and retain good commutation and brush life.
---------------------	--

PVC Environment Brush	Special brush grade to allow motor to be operated in a environment where PVC is present.
-----------------------	--

Conduit box

Conduit Box Type

One Size Larger than Standard	Note: Not available on DC180ATZ, DC2112ATZ, C400ATZ or C440ATZ frames. To obtain this modification on DC180ATZ frame price a C180ATZ frame by using the 500V armature basic motor price at same Hp and base speed.
-------------------------------	--

Cast Iron Standard Sizes	Note: Not available on C400ATZ and larger.
--------------------------	--

Mill Type	Heavy gauge, large rectangular metal box standard for frames C400ATZ and larger. Note: Not available on DC180ATZ or DC2112ATZ frames. To obtain this modification on DC180ATZ ratings, price a C180ATZ frame.
-----------	---

Oversize Mill Type Conduit Box	Note: Applicable only on C400ATZ thru C4400ATZ frames.
--------------------------------	--

Top Mounted Conduit Box	Note: Conduit box cannot be located in the same quadrant as blower on frames C440ATZ and below. Frames DC180ATZ and DC2112ATZ have top mounted conduit box as standard.
-------------------------	---

Explosion-Proof Conduit Box on Separately Ventilated Motor

Add to pipe-in, pipe-out (TESV) motors only. Provides a motor with explosion-proof conduit box, four thermostats on the intercoil windings, explosion proof air pressure switch, two thermostats on the main field winding and special nameplate to indicate that the motor, when separately ventilated with required air flow and installed in accordance with the National Electric Code (NFPA 70) and applicable local codes, is suitable for use in Class 1, Group D, Division 2 locations for temperature code T2D. The three thermostats will be connected in series inside the motor with only two leads brought into the terminal box. The motor control must disconnect motor power immediately in an orderly manner when the NORMALLY CLOSED thermostats trip. THE ADDITION OF THIS MODIFICATION DOES NOT PROVIDE A UL LISTED EXPLOSION-PROOF MOTOR. Refer to Application Data section HAZARDOUS LOCATIONS for additional application details. For Class 1, Groups A, B, or C and Class II applications, contact a local ABB Sales Office.

Note: Not available on DC180ATZ or DC2112ATZ frames. To obtain this modification on DC180ATZ frame price a C180ATZ frame by using the 500V armature basic motor price at same Hp and base speed.

Covers

Cover Type	
Splashproof Covers	For drip proof machines to meet NEMA MG1-1.25.2 requirements for splashproof enclosures. Provides protection against liquid drops or solid particles from entering the motor at any angle not greater than 100 degrees downward from the vertical.
Transparent Hand Hole Cover	This modification provides a cover made of polycarbonate plastic as a substitute for one solid (not screen or louvered) steel cover. This substitution does not change the basic enclosure (drip-proof, etc.). Cannot be added to DC180ATZ frames with DPG enclosure or any explosion proof enclosure.
Vertical Mount Hand Hole Covers	Special drip covers to insure drip-proof protection for vertically operated foot or flange mounted motors.
Drip Cover	Drip cover for standard TEFC motors for extra protection from dripping liquids and falling objects when motor is mounted in vertical shaft down position. Not available when accessories (brakes, feedback devices etc.) are mounted on the ODE.

Drain plugs

Type	
Standard "T" Drain	
Automatic Breather Drain Stainless Steel	Drain Plugs are at the lowest point of the motor.

Enclosures

Separately Ventilated (DPG-SV)- For applications where ventilated air is piped into the machine from an external source, basic DPG-FV enclosures may be separately ventilated at 3, 6, 9 and 12 o'clock for the following list price deductions. The inlet pipe can be fastened to one end bracket, and, if required and specified, an outlet pipe can be fastened to the other end bracket. Price does not include blower or pipe. Locations of air entry and air exhaust, if used, should be specified on order. Motors must not be operated without the separate air supply. Refer to Application Data Section for separate ventilating air requirements. If air is to be vented out of the bottom, clearance must be provided for that example. To insure adequate protection of a separately ventilated motor against loss of cooling air, an overtemperature device for interlocking with the controller overload protection circuit is recommended and should be added as standard practice. An air pressure differential switch is also recommended.

Enclosure Type	
Separately Ventilated- Pipe In	
Separately Ventilated- Pipe In & Out	Totally Enclosed Air Over (TEAO) - For Applications requiring a totally enclosed fan cooled motor with external ventilation independent of motor shaft speed. Required for continuous constant torque operation below 60% base speed. Add all TEAO modification prices to TEFC basic motor price.
TEAO Inline	Similar to TEFC construction, except with external ventilating fan driven by AC motor flange mounted to fan shroud. Double shaft extension or tachometer mounting is not available. Includes 3-phase 60 Hz 230/460 Volt AC Induction Motor without starter. Note: Not available on DC180ATZ frame. To obtain this modification on DC180ATZ frame price a C180ATZ frame by using the 500V armature basic motor price at same Hp and base speed.
TEAO Piggyback	Similar to TEFC construction, except with top mounted blower and shroud to direct ventilating air over motor frame. Includes 3-phase 60 Hz 230/460 Volt AC Induction Motor without starter. Available on C180ATZ through C4400. Note: Not available on DC180ATZ frame. To obtain this modification on DC180ATZ frame price a C180ATZ frame by using the 500V armature basic motor price at same Hp and base speed.
TEAO Inline Explosion Proof	Similar to TEFC construction, except with external ventilating fan driven by explosion-proof AC motor flange mounted to fan shroud. Double shaft extension or tachometer mounting is not available. Includes 3-phase 60 Hz 230/460 Volt AC Induction Motor without starter. Refer to Pricing Section for applicable Classes and Groups. Add modification list price to TEFC-XP basic motor list price.
TEAO Piggyback Explosion Proof	Similar to TEFC construction, except with top mounted blower and shroud to direct ventilating air over motor frame. Includes explosion-proof 3-phase 60 Hz 230/460 Volt AC Induction motor without starter. Available frames XC180ATY, XC250ATY and XC320ATY. Refer to Pricing Section for applicable Classes and Groups. Add modification list price to TEFC-XP basic motor list price.

Enclosure enhancements - severe duty

Enclosures	
XT Features	<p>The XT motor is designed for operation in damp locations where the motor will be subjected to corrosive conditions. Typical applications are paper, chemical, petroleum, fertilizer and plastics industries. XT motors are provided in totally enclosed non-ventilated, totally enclosed fan-cooled, totally enclosed separately ventilated, totally enclosed air-over. Refer to Application Data Section for complete description of XT Motor Construction.</p> <p>Motors operating in dirty areas with fine abrasive dust such as taconite surrounding the motor should have Dustproof/ Taconite features added in addition to this modification</p>
Outdoor Duty - Weather Proof-Washdown	<p>This washdown modification provides a motor suitable for operation outdoors subject to direct weather conditions. Applicable enclosures are totally enclosed nonventilated, totally enclosed fan-cooled, totally enclosed separately-ventilated, totally enclosed air-over.</p> <p>Outdoor duty motors include the features of XT motors plus extended hoods over the fan inlets on TEFC and TEAO enclosures to prevent water being blown over the frame by the fan or blower. Additional sealing around the hand hole covers is provided to prevent entrance of water applied from a hose. Slingers are provided on shaft extensions.</p> <p>Washdown duty motors must have a lip seal modification added for each exposed external shaft extensions.</p> <p>Outdoor duty motors must have space heaters or the fields energized at reduced (usually 50%) voltage to protect against condensation when the motor is not operating.</p> <p>Motor accessories such as brakes must be specified and priced as suitable for outdoor use. Standard tachometers are not recommended for outdoor duty. Motors operating in dirty areas with fine abrasive dust such as taconite surrounding the motor should have Dustproof / Taconite features added in addition to this modification.</p>
Paper Mill Duty Features	<p>The paper mill duty motor is designed for operation at the wet end of a paper mill and in other harsh environments. This modification can be provided on separately ventilated, force-ventilated, drip-proof or totally enclosed motors. Paper Mill Duty Motor construction and features can be seen in the Application Data Section for Paper Mill Duty Feature Modification.</p>
Crane & Hoist Duty	<p>Crane & Hoist Duty (C180ATZ - C440ATZ) – The Outdoor Crane & Hoist duty motor provides severe duty features for crane duty motors such as Hoist, Gantry and Trolley motors. For Outdoor Crane & Hoist environments, make the following pricing additions to TENV and TEFC. For Indoor Crane & Hoist environments, DPV motors can be utilized. Crane & Hoist Duty Motor construction and features can be seen in the Application Section for Crane & Hoist Duty Modification.</p>
Press Duty High Vibration	<p>Press Duty motor is suitable for applications in which the motor is exposed to higher than normal mechanical stress and high vibration. This modification increases the motor mechanical endurance up to a maximum of 3G's of shock for applications such as a stamping press line. Standard features include high vibration blower (when applicable), special high vibration insulation system and lock washers and loctite for all nuts and bolts.</p>

Feedback devices Hollow shaft encoders

Mounts on the motor stub shaft with no coupling required. A Tether-Arm mounts to the motor bracket and provides insulation from shaft currents. Standard Output is two channels (A & B), quadrature.

Encoder Type	PPR	Power VDC	Max Oper. Temp.	Max Oper. Speed	Output
BEI HS-35	Up to 5000	5 - 15V	70°C	6000 rpm	Single Output
					Dual Output
Dynapar HS-35R	Up to 5000	5 - 26V	70°C	6000 rpm	Single Output
					Dual Output
Northstar / Lakeshore HSD-35	Up to 5000	5 - 26V	70°C	6000 rpm	Single Output
					Dual Output
Avtron HS35M	Up to 3072	5 - 26V	85°C	6000 rpm	Single Output
Avtron HS45	60 to 5000	5 - 24V	100°C	5000 rpm	Single Output
					Dual Output
Northstar / Lakeshore HS-56	Up to 2048	5 - 26V	80°C	3600 rpm	Single Output
					Dual Output
Avtron HS-M4	240 to 1200	5 - 24V	85°C	5000 rpm	Single Output
					Dual Output
Avtron AV685 SMARTachII™	8 to 5000	5 - 24V	85°C	4000 rpm	Single Output
					Dual Output

- BEI HS-35 – A Photoelectric Encoder suitable for applications involving Robotics, Oil Service & Web Process Control. Enclosure meets IP65. Comes standard with a 10 Pin Mating MS Connector.
- Dynapar HS-35R – (Replaces HS-35) A Photoelectric Encoder. Enclosure meets IP67. Comes standard with a 10 Pin Mating MS Connector.
- Northstar / Lakeshore HSD35 – A heavy duty photoelectric hollow shaft encoder. Dynapar has replaced the HS35M with this HSD35 encoder. The industrial duty latching connector is standard.
- Avtron HS35M – Magnetic hollow shaft encoder.
- Avtron HS45 – (Replaces M3) Magneto-resistive encoder suitable for Mill Duty applications. Enclosure is IP65 sealed against dirt, water, dust and chemical ingress. Comes standard with a 10 pin industrial connector. For 2 inch and 2.375 in hollow shaft see Avtron M4.
- Northstar/Lakeshore HS-56 – A Magnetoresistive Encoder suitable for applications involving Grease, Salt Water, Dust or other common contaminants. Enclosure is chemical resistant to salt spray, most solvents, mild acids, and bases. Comes standard with a 10 Pin Latch Style Industrial Connector.
- Avtron HS-M4 – A Magnetoresistive Encoder suitable for Heavy Mill Duty applications. Enclosure is Liquid & Dust tight, and a Stainless Steel Breather Drain is supplied. Comes standard with a 10 Pin Industrial Connector. 1.5 to 2.375 inch bore diameter.
- Avtron AV685 – (Replaces M685) A heavy mill duty magnetoresistive modular pancake encoder suitable for severe duty applications, ideal for larger motors.

Coupled encoders

Mounts to motor with the use of a stub shaft, flexible coupling & flange adapter. Standard Output is two channels (A & B), quadrature.

Encoder Type	PPR	Power VDC	Max Oper. Temp.	Max Oper. Speed	Output
Dynapar H20	1 - 2500	5 - 26V	85°C	5000 rpm	Single Output
BEI H-25	500, 1000, 1024	5 - 24V			Single Output
Allen Bradley 845H	1024 / 2048	8 - 24V	60°C	6000 rpm	Single Output
Dynapar H56	1024 / 2048	5 - 26V	80°C	3600 rpm	Single Output Dual Output
Avtron AV485 SMARTachII™	8 - 5000	5 - 24V	85°C	4500 rpm	Single Output Dual Output

- Dynapar H20 – A Photoelectric Encoder suitable for Industrial Motion applications. Enclosure meets IP66. All Dynapar encoders are CE labeled.
- A BEI H25 encoder with a servo style shaft and flange mounted to the commutator end of the motor. Encoder has index marker with complements, and line driver.
- Allen Bradley 845H – A Photoelectric Encoder suitable for Industrial applications. Enclosure meets IP66.
- Dynapar H56 – A direct replacement for the RD62 for mill duty applications. The H56 is a Photoelectric Encoder suitable Severe Duty Applications. Enclosure meets IP66. All Dynapar encoders are CE labeled.
- Avtron AV485 – (Replaces M485) A Magnetoresistive Encoder suitable for Severe Duty (IP66) applications. Enclosure is sealed against Dust & Water ingress. Comes standard with a 10 Pin Industrial Connector. NEMA 56C face pancake mounting with stainless steel shaft, sealed bearings and shaft seal.

Bearingless encoders

Mounts directly to the motor stub shaft without bearings or couplings. The Pulse Wheel of this type of encoder mounts directly to the motor stub shaft, which is then encased by the bracket of the encoder.

Encoder Type	PPR	Power VDC	Max Oper. Temp.	Max Oper. Speed	Footnotes
Dynapar RD-120-1	120	5 - 15V	80°C	6000 rpm	Single Output (B) (C) (D)
Dynapar RD-120-2	120	5 - 15V	80°C	6000 rpm	Dual Output (B) (C)
Northstar/Lakeshore ST67	1024/2048	5 - 15V	90°C	7000 rpm	Single Output(B)
Northstar/Lakeshore ST85 Single or Double C-Face	64 - 2048	5 - 15V	90°C	7000 rpm	Single Output Dual Output
Avtron AV85 ThinLineII™	8 - 5000	5 -24V	100°C	5400 rpm	Single Output Dual Output
Avtron AV850 SMARTach II	8 - 5000	5 - 24V	100°C	5400 rpm	Single Output Dual Output
Northstar/Lakeshore RIM8500	64 - 600	5 - 26V	80°C	7000 rpm	Single Output
	64 - 600				Dual Output
	960, 1024 or1200				Single Output
	960, 1024 or1200				Dual Output
	2048				Single Output
	2048				Dual Output
Northstar/Lakeshore RIM1250	1024/2048	5 - 26V	80°C	7000 rpm	Single Output
					Dual Output

- Danaher RD-120 – A Magnetoresistive Encoder suitable for Mill Duty applications. Designed to fit the front end cavity of RPM III motors, it adds only 1.88” to motor length. It is available for single direction of motor operation, or as the RD-120-2 for reversing applications.
- Northstar/Lakeshore ST67 – A Magnetoresistive Encoder suitable for Mill Duty applications. Enclosure allows for heavy machine vibration and accidental impacts. The RL67 adds only 1.0” to overall motor length. Comes standard with 10 Pin Latch Style Industrial Connector.
- Northstar/Lakeshore ST85 – A Magnetoresistive Encoder suitable for Mill Duty applications. Enclosure allows for heavy machine vibration and accidental impacts. The SL85 adds only 1.25” to overall motor length. Comes standard with 10 Pin Latch Style Industrial Connector.
- Avtron AV85 – (Replaces M85) A thin line magnetoresistive encoder suitable for Heavy Mill Applications. Large sensor-rotor air gap. Double C-Face design. Comes standard with 10 pin Latch Style Industrial Connector.
- Avtron AV850 SMARTach II™ – (Replaces the M285) magneto-resistive modular pancake Tach with 8.5" double C-Face. Comes standard with 10 pin Latch Style Industrial Connector.
- Northstar/Lakeshore RIM8500 – A Magnetoresistive Encoder suitable for Rugged Mill Duty applications. Enclosure is made of Ductile Cast Iron. Comes standard with 10 Pin Latch Style Industrial Connector. Offered with a maximum shaft diameter of 2.875". Contact a local ABB Sales Office for shaft diameters up to 3.75".
- Northstar/Lakeshore RIM1250 – A Magnetoresistive Encoder suitable for Rugged Mill Duty applications. Enclosure is made of Ductile Cast Iron. Comes standard with 10 Pin Latch Style Industrial Connector. Offered with a maximum shaft diameter of 2.875". Contact a local ABB Sales Office for requirements with larger shaft diameters, up to 8.00".

Notes: (B) Cannot be used with opposite drive end brake.

(C) May not be used on TENV frames DC180, DC210 or C180.

(D) Unidirectional.

Explosion-proof encoders

A coupled encoder approved for National Electric Code (NEC) Class I & II, Divisions I & II, Groups C, D, E, F & GasUL Listed, Explosion Proof.

Encoder Type	PPR	Power VDC	Max Oper. Temp.	Max Oper. Speed	Footnotes
Dynapar X25	1 - 5000	5-26v	70°C	5000 rpm	Single Output

- Dynapar X25 - A Photoelectric Encoder Suitable for Explosion Proof Applications & Environments. Enclosure meets IP56.

Resolvers

A resolver is a shaft angle sensing transducer. Interfacing with an input module, the resolver provides position and velocity feedback information to the Control System. Three outputs are available to meet application requirements. Resolvers are provided in industrial duty and heavy duty industrial enclosures and can be face or foot mounted. Heavy duty resolvers with double shaft extensions can be supplied when a second feedback device such as an overspeed switch is required mounted in line. The table below defines the available outputs and mounting arrangements. The price includes mounting of the resolver to the motor.

Type
Resolver 607980-38A – XP Class I Group C and D, 3000 rpm max.
Resolver 800123-2R – used with 1750 rpm motors.
Resolver 800123-2S – used with motor with top speeds of 1150 rpm and less.
Resolver 800123-2T – sometimes used with motors with top speeds of 500 rpm and less.
Resolver 800123-R – used with 1750 rpm motors.
Resolver 800123-S – used with motor with top speeds of 1150 rpm and less.
Resolver 800123-T – sometimes used with motors with top speeds of 500 rpm and less.
Resolver 800123-1R – includes scoop for mounting an overspeed switch or other feedback device, used with 1750 rpm motors.
Resolver 800123-1S – includes scoop for mounting an overspeed switch or other feedback device, used with motor with top speeds of 1150 rpm and less.
Resolver 800123-1T – includes scoop for mounting an overspeed switch or other feedback device, sometimes used with motors with top speeds of 500 rpm and less.

Resolver parT No. 800123-	Features on above Resolvers								
	2R	2S	2T	R	S	T	1R	1S	1T
1X (360- electrical = 360- mechanical)	•			•			•		
2X (360- electrical = 180- mechanical)		•			•			•	
5X (360- electrical = 72- mechanical)			•			•			•
Flange Mount	•	•	•						
Foot Mount & C-Face				•	•	•	•	•	•
Single Shaft	•	•	•	•	•	•			
Double Shaft							•	•	•
General Industrial Duty	•	•	•						
Heavy Industrial Duty				•	•	•	•	•	•
Use with Flange Type Mounting Adapter	•	•	•	•	•	•			
Use with Scoop Mount							•	•	•

Tachometers

Analog tachometer generators mount to motor with the use of a stub shaft, flexible shaft coupling & flange adapter (all except TG300-19). Tachometers output is an analog signal, either DC or AC, proportional to the speed at which the tachometer is rotating.

Tachometer Type	Description	V/1000RPM	Max. Speed
XPY IV	Baldor-Reliance XPY IV tachometers mounted to commutator end of the motor.	50 DC	5000 RPM
		100 DC	2500 RPM

Speed limit switch

NEMA I enclosed centrifugal switch flange or scoop mounted on commutator end bracket. Provides output contact when motor reaches a predetermined calibrated speed. Form C contacts rated 120, 240, or 480 volts 60 Hz, 360 volt-amps or 125 VDC at 25 amps, 240 VDC at 12 amps.

Switch Enclosure

NEMA 1

UL Listed

Provisions for mounting only

PROVISION- APPLICABLE TO DPG, SP, TENV, SEP VENT, FV, and TEAO-PIGGYBACK ENCLOSURES.

Requires specific brand and part number of feed back device with order entry.

Machined motor bracket and counter bore of opposite drive end shaft only.

Machined motor bracket and stub shaft with protective cover over stub shaft.

Stub shaft on motor with Opposite Drive End Shaft Extension. (Modifications for standard opposite drive end extension and shaft guard must also be added.)

Machined motor bracket, cast iron adapter, stub shaft and coupling for mounting of any feedback device with 56 C-Face or PY flange device.

PIGGYBACK MOUNTING PROVISION – Allows one of the tachometers to be coupled to the motor by means of a timing belt. Use this adder in addition to the flange mounted prices.

PROVISION-APPLICABLE TO TEFC ENCLOSURES. Requires specific brand and part number of feedback device with order entry.

Adapter, stub shaft and coupling - for future mounting of any feedback device with 56 C-Face, or PY flange device.

Field windings

Field Winding Mod.

Dual Voltage Shunt Field	Fields may be provided as series-parallel connections for dual voltage, such as 150/300 volts or 120/240 volts. When specifying a dual voltage field, the higher voltage will be the standard field voltage and the lower voltage will be 1/2 of the higher voltage.
Continuous Duty Shunt Field	Continuous Duty Shunt Field for Standby Condition. Standard continuous duty DPG, TEFC, and TENV DC motors have continuous duty fields capable of continuous excitation at standstill (armature circuit not energized) under normal industrial conditions. This addition is required for continuous fields on intermittent duty (30 or 60 minute) motors. IMPORTANT: Motors designed for forced ventilation or with a dual-cooled heat exchanger as standard must have cooling air when fields are excited at rated voltage. Installations having the air supply interrupted when the motor is not operating must have field disconnected or field voltage reduced to 50% rated by the control. Continuous duty fields can not be provided on these motors.
Standard Compound Field	A standard compound wound motor has a speed regulation of approximately 30% in accordance with NEMA Standard MG1-12.65.2. Compound wound motors are not suitable for operation over an extended field range by shunt field weakening because of the very high no-load speeds that may result. A full load range of 1.25:1 is the usual maximum. Note: Not available on C440ATZ frame. WARNING: Motor control must limit motor speed to Maximum Safe Speed listed in Application Data Section, and stamped on the motor nameplate.
Stabilized Shunt Field	The standard DC motor has a separately excited straight shunt field which may have a rising speed characteristic. This adder provides a stabilizing winding that will ensure a drooping speed characteristic. Note: Not available on C440ATZ frame. WARNING: Motor control must limit motor speed to Maximum Safe Speed listed in Application Data Section, and stamped on the motor nameplate.
Series Field	WARNING: Series wound motors must be solidly connected to the driven machine and never operated without load to avoid possible destructive high speeds. The speed of a series motor is defined only at rated load.
Special Field Voltage	Standard shunt field voltages are specified on the basic rating pages. Add this modification for field voltages not listed as standard.

- Filter Addition for DPG - FV motor with motor mounted blower. Filter is washable type. Recommended when filterable contaminants are present. Totally enclosed construction rather than blower with filter is recommended for extremely dusty, dirty environments.
- Standard DPG - FV designs are supplied with motor mounted blower without filter. Basic list price for force ventilated motors includes 3-phase, 50/60 Hz, 230/460 volt blower motor but no starter. Blower motor on DC180ATZ frame may be single phase, 230 volts if specified.
- Motor mounted blowers cannot be added to standard DPG ratings. Refer to Application Data Section for speed vs. torque operation of a DPG enclosure. Operation of self-ventilated motors at continuous full load torque below approximately 60% base speed requires a force ventilated (DPG-FV) enclosure priced from the basic rating pages.
- To insure adequate protection of a blower ventilated motor against loss of cooling air, an over temperature device for interlocking with the controller overload protection circuit is recommended and should be added as standard practice. An air pressure switch is also recommended.

IMPORTANT:

Motors designed for forced-ventilation as standard must have cooling air when fields are excited at rated voltage. Installations having the air supply interrupted when the motor is not operating must have fields disconnected or field voltage reduced to 50% rated by the control.

Footless frame

Modification

Footless Frame	Motor feet are removed. Add C-Face or D-Flange for mounting motor. Available only on DC180ATZ, C180ATZ, DC2112ATZ.
----------------	--

Gearmotor provisions

Modification

Gearmotor Provisions	Includes a D-Flange, footless frame (when applicable), shaft lip seal, and special shaft with threads and nut for Gear Pinion Mounting.
----------------------	---

Insulation

Insulation System Mod.

Tropical Protection	Standard DC motors utilize an advanced insulation system that provides excellent protection against fungus and high humidity as found in tropical climates. The standard motor is suitable for operation in tropical climates without additional treatment. (Refer to the General Information section for features of the insulation system.) For additional protection, especially during shipment and prolonged storage, this modification provides a fungicidal air dry varnish treatment per MIL-V-173C (Type I Treatment) applied over all motor windings. Important: Motors applied in highly corrosive, moist and dirt-laden environments should have an enclosure with XT features to limit the entrance of contaminants into the motor.
Insulation Class H	Total insulation system is of a class H design, motor is class F temperature rise for longer insulation life.
VPI Insulation	VPI insulation system provided on armature and stationary coils.

Leads

Lead Modification

Extra Length Leads	For armature and field leads longer than standard. Add List Price per foot of additional lead length requested.
Lead Lugs- Standard Type	
Lead Lugs - Burndy	Crimp type lead lugs for armature and any series fields.
Terminal Board in Main Conduit Box	
Terminal Board	Provides terminal board in conduit box for armature, shunt field, and series field connections instead of the standard leads. Also includes auxiliary terminal strip for thermostat and accessory leads. Note: Not available on DC180ATZ, DC212ATZ or any explosion-proof frames.

Lubrication

Grease

High Temp-Dow 44 J
Mobilith SHC-1 00 v/
Mobilith SHC-220 w
Mobilith SHC-460 J
Low Temp. Aero Shell #7
Custom

Overload, special momentary

- A. In accordance with NEMA MG1-12.68, standard direct current motors shall be capable of operating with successful commutation for a period of one minute with a current load of 150 percent of the base speed full-load current at all speeds within the rated speed range. Refer to ABB for momentary overloads greater than standard. Specify magnitude, duration, speed range and frequency of occurrence.
- B. For machine capable of carrying 125 percent rated load current for two hours, use the price of the listed machine with the same enclosure and speed with a) horsepower rating equal to 125 percent of the nominal rating. If the rating thus calculated is not standard, use the next higher standard rating.

Packaging

Packaging Modification

Standard or Euro Pallet	
Open Slat Crate	Provides additional protection for air and land shipment..
Enclosed Crate	Provides enhanced protection for ocean shipment. Does not provide for any overseas fees, documentation, etc.

Paint

Paint Modification

Special Paint-Factory Supplied	Special color paint, refer to Application Data Section for a description at standard paint finish. Supply Federal Standard, RAL number or paint chip with order. Special color or type of paint must be compatible with our standard air dry primer.
Two-Coat Epoxy	2 coat epoxy/Omega Plus is a paint system that provides protection to moderate chemical environments and UV exposure, ISO C-3.
Extreme Paint System	Extreme duty paint system for marine duty/offshore or highly corrosive atmospheres, requires a sand blast surface preparation, ISO C-5.
Custom	Custom paint system requires customer to supply specification for sales/engineering review.

Service factor

Standard listed motors are for 1.0 service factor. For greater than standard service factor, use the price of the listed machine with the same enclosure and speed with a horsepower rating equal to the rated Hp times the required service factor. If the Hp thus calculated is not standard, use the next higher standard rating.

Note: Paper Mill Service motors with Class B rise listed in Pricing Section may be operated at 1.15 Service Factor with a Class F rise.

Shaft modifications

Shaft Modification

Standard Opposite Drive End Shaft Extension	Opposite Drive End (Commutator End) Shaft Extension having dimensions per the standard dimension sheets. Note: Not suitable for tandem motor operation. If tandem motors are required, contact a local ABB Sales Office.
Shaft Guard	Provides a protective cover over opposite drive end shaft extensions. WARNING: To prevent injury, shaft guard must be specified or supplied by customer for exposed shaft extensions.
Shaft Grounding Brush	Protects bearings from failure caused by circulating shaft currents.
Ground Provision, External	Provides a drilled and tapped hole, complete with fastener and star washer for external grounding located on bracket foot for C180ATZ through C440ATZ frames.
Special Shaft Diameter – Drive End	Non-standard shaft with dimension less than standard diameter or larger than standard with the maximum diameter as listed in table below.
Special Shaft Diameter – Opposite Drive End	Non-standard shaft having dimension less than standard diameter or larger than standard with the maximum diameter as listed in table below. Do not add shaft grounding brush when adding this modification.

Maximum allowable shaft diameters									
Frame	Opposite Drive End		Drive End		Frame	Opposite Drive End		Drive End	
	Std. 'FU'	Max 'FU'	Std 'U'	Max 'U'		Std. 'FU'	Max 'FU'	Std 'U'	Max 'U'
DC180ATZ	1.125	1.125	1.125 ¹	1.125 ¹	C2815ATZ	2.125	2.125	2.375	2.875
C180ATZ	1.125	1.125	1.375	1.5	UC2815ATZ	2.125	2.125	2.625	2.875
DC2112ATZ	1.125	1.125	1.125	1.125	C320ATZ	2.25	2.5	2.625	2.75
C210ATZ	1.625	1.75	1.875	1.875	UC320ATZ	2.25	2.5	2.875	3.25
C2512ATZ	1.875	1.938	2.125	2.25	C360ATZ	2.875	3.125	2.875	3.625
C2514ATZ	1.875	1.938	2.375	2.5	UC360ATZ	2.875	3.125	3.25	3.625
C2515ATZ	1.875	1.938	2.375	2.5	C400ATZ	3.625	3.625	3.625	3.625
C2812ATZ	2.125	2.125	2.375	2.5	UC400ATZ	3.625	3.625	4.125	4.125
UC2812ATZ	2.125	2.125	2.625	2.875	C440ATZ	3.625	3.625	3.625	4.125
C2813ATZ	2.125	2.125	2.375	2.875	UC440ATZ	3.625	3.625	4.125	4.125
UC2813ATZ	2.125	2.125	2.625	2.875					

¹ "U" of 1.375 available with D-flange bracket

Shaft Modification

Special Shaft Length	Non-standard length for either drive end or opposite drive end shaft (use twice modification price for non-standard length on both ends). Maximum length limited to two times standard length. CAUTION: Belted drives using smaller than standard diameter shafts and/or longer than standard shafts must be referred to a local ABB Sales Office with complete belt drive data.
Non Contact Seal - Inpro®	This labyrinth non-contact brass Inpro® bearing isolator on either motor bearing protects against liquids, solids, steam and slurry. Efficiency is maintained with no seal drag. Add per seal. Note: Not available on DC180ATZ or DC2112ATZ frames. To obtain this modification on 180 frame, price a C180ATZ frame by using 500 volt armature basic motor rating at same HP and base speed.
Lip Seal	This modification provides a lip seal on either bearing to protect the bearing when operated with oil splashing against the shaft. Typical application is on a horizontal motor mounted to a gear case where the stationary oil level is below the motor shaft. Seals operated dry for extended periods will be damaged. Add per seal.
Face Seal	Provides a face seal on the drive end to protect the bearing when operated with a head of oil against the shaft. Typical application is a vertical shaft-up motor connected to a gear case with oil against the motor shaft. Seals operated dry for extended periods will be damaged. Note: Not available on DC180ATZ or DC2112ATZ frames. To obtain this modification on 180 frame, price a C180ATZ frame by using 500 volt armature basic motor rating at same HP and base speed.
Dustproof/Taconite Features	This modification provides non-magnetic labyrinth-path seals on all exposed shafts. This modification intended for totally enclosed machines only for protection against fine, abrasive dust such as taconite. Note: Not available on DC180ATZ or DC2112ATZ frames – to obtain this modification, price a C180ATZ frame by using 500 volt armature basic motor rating at same Hp and base speed.
Shaft Slinger Seal	This modification helps protect either bearing from oil and dust contamination. C180ATZ- C440ATZ use nitrile rubber slingers. Add per seal.
Shaft Step	Each step or reduced diameter from standard straight shaft. Modification for shaft threads is usually required with this modification.
Shaft Threads	Class 2A right hand thread of size compatible with shaft diameter. Modification for a stepped shaft is usually required with this modification.
Shaft Tapered	Provides standard NEMA AC shaft tapered 1.25 inches per foot. May be added for either drive end or opposite drive end shaft extension. Includes threads, washer, and locknut. Specify 'U' or 'FU' required.
Special Shaft Material AISI 4140/4150	Standard shaft material is AISI 1045 for C180 thru. Add for AISI 4140/4150 on these frames if required.
Special Shaft Material 316 stainless	Standard shaft material is AISI 1045 for C180 thru C440. Add for 316 stainless.

* Contact sales team for availability and price of forged alloy steel shaft on B840 thru B1600.

Space heaters

Modification

Space Heaters	Mounted inside the motor. Recommended to prevent condensation for motors remaining unenergized for long periods of time. Standard heater is single phase 120, 240, or 480 volts, 50/60 Hz. Leads are terminated in motor conduit box unless modification for Separate Conduit Box for Space Heater Leads is specified. Note: Not available on DC180ATZ or DC2112ATZ frame - to obtain this modification on 180 frame, price a C180ATZ frame by using 500 volt armature basic motor rating at same Hp and base speed.
Separate Conduit Box for Motor Space Heater Leads	Not available on explosion-proof frames, DC180ATZ, or DC2112ATZ.
Space Heater on Motor Mounted Brake	Add when space heater is mounted in motor.
3 - 105 lb-ft	
125 - 1000 lb-ft	
Speed – Base Speed 3500 RPM For 3500 RPM base speed designs listed on the basic rating pages, make the following adder to the basic list price.	

Speed range

Speed Range By Field Weakening Greater Than Standard – Applicable for Integral Horsepower DPG-SV and DPG-FV, 500v armature DC Motors. Provides for continuous duty, maximum speed by field weakening greater than the nominal field weakened speed listed. From the table below, determine the frame size needed for the field weakened speed required. Determine the list price from the basic motor price page by selecting the matching frame size.

WARNING:

Inherent speed regulation may cause high speed field weakened motors to exceed safe speeds at light loads. Motor speed control must be provided to hold the maximum safe speeds listed in the Application Data Section. Refer to a local ABB Sales Office for values of inherent speed regulation.

Speed range (continued)

EXTENDED CONSTANT HORSEPOWER RANGE BY FIELD WEAKENING – CONTINUOUS DUTY – 500V ARMATURE										
Price Motor by Frame Size										
Base Speed	Fld. Weakened	5 Hp	7.5 Hp	10 Hp	15 Hp	20 Hp	25 Hp	30 Hp	40 Hp	50 Hp
1750	1950	C1811	C1811	C1812	SC2113	SC2113	MC2113	LC2113	MC2115	LC2115
	2300	C1811	C1811	C1812	SC2113	SC2113	MC2113	LC2113	MC2115	MC2512
	2700	C1812	C1812	SC2113	SC2113	MC2113	LC2113	SC2512	LC2115	MC2512
	3000	C1812	SC2113	SC2113	SC2113	LC2113	LC2113	SC2512	LC2115	MC2812
1150	basic	C1811	C1812	SC2113	MC2113	LC2113	MC2115	LC2115	LC2512	C2514
	1900	C1812	SC2113	SC2113	MC2113	LC2113	LC2115	LC2115	LC2512	C2514
	2000	C1812	SC2113	SC2113	MC2113	LC2113	LC2115	MC2512	LC2512	C2515
	2300	SC2113	SC2113	SC2113	LC2113	SC2512	SC2512	LC2512	C2514	C2515
850	basic	C1812	SC2113	SC2113	LC2113	LC2115	MC2512	LC2512	C2514	C2515
	1700	SC2113	SC2113	LC2113	LC2113	MC2512	C2514	C2514	LC2812	C2815
	2200	SC2512	SC2512	SC2512	LC2512	LC2512	LC2812	LC2812	MC3212	MC3212
	2400	SC2512	SC2512	SC2512	LC2512	MC2812	LC2812	LC2812	MC3212	MC3212
	2500	SC2512 (2600)	SC2512	MC2512	LC2512	LC2812	LC2812	LC2812	MC3212	MC3212
650	basic	SC2113	MC2113	MC2115	LC2115	LC2512	C2514	C2515	C2515	C2815
	1600	MC2113	LC2113	SC2512	LC2512	MC2812	LC2812	LC2812	LC2812	C3214
	1950	MC2113	LC2512	LC2512	MC2812	MC2812	LC2812	MC3212	MC3612	C3214
	2400	SC2512	LC2512	MC2812	LC2812	LC2812	MC3212	C3214 (2550)	MC3612	LC3612 (2300)
500	basic	MC2113	LC2113	MC2115	LC2512	C2514	LC2812	C2815	C2815	C3214
	1300	SC2512	SC2512	LC2512	C2514	LC2812	LC2812	C2815	MC3612	MC3612
	1500	SC2512	MC2812	LC2512	C2514	LC2812	C2815	C2815	MC3612	MC3612
	1850	MC2812	MC2812	MC2812	LC2812	C2815	LC3212	MC3612	MC3612	MC3612 (1800)
	2000	MC2812	MC2812	MC2812	LC2812	LC3214	MC3612	MC3612	LC3612	C3613

Base Speed	Fld. Weakened	60 Hp	75 Hp	100 Hp	125 Hp	150 Hp	200 Hp	250 Hp	300 Hp	400 Hp
1750	1950	LC2512	C2514	C2515	C2813	C2815	C3214	LC3612	LC3613	MC4013
	2300	LC2512	C2514	LC2812	C2813 (2500)	C2815	C3214	LC3612	LC3613	—
	2700	MC2812	C2514	LC2812	C2815 (3400)	C2815	C3214	LC3612	—	—
	3000	MC2812	LC2812	C2815	C2815 (3400)	C2815	C3214	MC4013	—	—
1150	basic	C2515	C2815	C2815	C3214	LC3612	C3613	MC4013	LC4013ATZ	C4414
	1900	C2515	C2815	C2815(1850)	C3214	LC3612	C3613	MC4013	LC4013ATZ	—
	2000	LC2812	C2815	LC3212	C3214	LC3612	C3613	MC4013	LC4013ATZ	—
	2300	C2815	C2815	LC3212	LC3612	C3613	C3613	MC4013	—	—
850	basic	C2815	C2815	C3214	LC3612	C3613	MC4013	LC4013	—	—
	1700	C2815	LC3212	C3214	LC3612	C4011	MC4013	LC4013 (1850)	—	—
	2200	MC3612	MC3612	C4011	C4011 (2170)	MC4013	LC4013	C4413 (2000)	—	—
	2400	MC3612	LC3612	C4011	MC4013	MC4013	LC4013	—	—	—
	2500	MC3612	LC3612 (2550)	C4011	MC4013	MC4013	LC4013	—	—	—
650	basic	C3214	LC3612	C3613	MC4013	MC4013	C4413	C4413	—	—
	1600	C3214	LC3612	C3613	MC4013	C4413	C4413	C4413 (1750)	—	—
	1950	LC3612	LC3612 (2100)	C4011 (2150)	C4413	C4413	C4413	—	—	—
	2300	LC3612	C4011	C4413	C4413	C4413	—	—	—	—
500	basic	LC3612	MC4013	MC4013	LC4013	C4412	C4414	—	—	—
	1300	LC3612	MC4013	MC4013	LC4013	C4414	C4414	—	—	—
	1500	LC3612	MC4013	MC4013 (1650)	C4413	C4414	C4414 (1650)	—	—	—
	1850	C4011	MC4013	LC4013 (2200)	C4414	C4414	—	—	—	—
	2000	C4011	MC4013	C4414 (1800)	C4414	C4414	—	—	—	—
	2500	—	C4414	—	—	—	—	—	—	—

Speed range (continued)

Winder Duty

These motors drive the center of a reel for winding a coil of strip material. The application is characterized by a continuously varying speed in the field speed range, limited overload requirements with peak overloads needed for acceleration and deceleration only, and short time operational the maximum speeds. Winder duty performance is defined as follows:

- “Winder Duty” means that at the maximum rated winder speed, the motor is limited to 100% armature current and on minute duty. There is no peak overload capability beyond 100% current at the winder speed. For speeds at or below the maximum continuous RPM, the standard NEMA overload criteria of 150% current for one minute applies.
- “Winder Duty” designs require the motor to be speed regulated. Refer to tables for percentage additions to motor price for extended winder duty field weakened speed.
- Applications requiring greater than 100% load at maximum speed, should be referred to ABB. Frame size may differ from basic size.

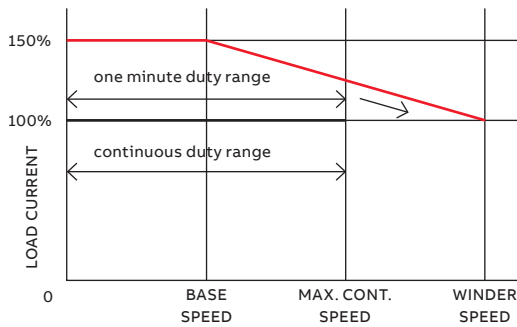

PERCENTAGE ADDITION TO BASIC MOTOR PRICE FOR EXTENDED FIELD RANGE ON DC MOTORS RATED 240 VOLT ARMATURE, WINDER DUTY IN DPG, DPFV OR TEDC ENCLOSURE.

Base Speed	Max. Speed By Field Control	Horsepower – 240 Volt Armature																				
		Power Code A or C																				
		1/2	3/4	1	1-1/2	2	3	5	7-1/2	10	15	20	25	30	40	50	60	75	100	125	150	
650	1950	0	0	0	0	0	0	0	0	0	0	0	0	0	0	0	0	0	0	0	0	
	2300	15	15	15	15	15	15	15	15	15	15	15	15	15	15	15	15	15	15	15	15	
	2400	15	15	15	15	15	15	15	15	15	15	15	15	15	15	15	15	15	15	15	15	
	2550	15	15	15	15	15	15	15	15	15	15	15	15	15	15	15	15	15	15	15	—	
	2600	15	15	15	15	15	15	15	15	15	15	15	15	15	15	15	15	15	—	—	—	—
	3000	(1)	(1)	(1)	(1)	(1)	(1)	(1)	20	(1)	(1)	(1)	(1)	(1)	(1)	(1)	(1)	(1)	—	—	—	—
500	2000	0	0	0	0	0	0	0	0	0	0	0	0	0	0	0	0	0	0	0	0	
	2300	10	10	10	10	10	10	10	10	10	10	10	10	10	10	10	10	10	10	10	10	
	2400	10	10	10	10	10	10	10	10	10	10	10	10	10	10	10	10	10	10	10	10	
	2500	10	10	10	10	10	10	10	10	10	10	10	10	10	10	10	10	10	10	10	10	
	2750	20	20	20	20	20	20	20	20	20	20	20	20	20	20	20	—	—	—	—	—	
	3000	(1)	(1)	(1)	(1)	(1)	(1)	(1)	20	20	(1)	25	25	25	25	(1)	25	25	—	—	—	—
400	1600	0	0	0	0	0	0	0	0	0	0	0	0	0	0	0	0	0	0	0	0	
	2000	10	10	10	10	10	10	10	10	10	10	10	10	10	10	10	10	10	10	10	10	
	2300	20	20	20	20	20	20	20	20	20	20	20	20	20	20	20	20	—	—	—	—	
	2400	20	20	20	20	20	20	20	20	20	20	20	20	20	20	20	20	—	—	—	—	
300	1200	0	0	0	0	0	0	0	0	0	0	0	0	0	0	0	0	0	0	0	0	
	1500	10	10	10	10	10	10	10	10	10	10	10	10	10	10	10	10	10	10	10	10	
	1800	15	15	15	15	15	15	15	15	15	15	15	15	15	15	15	15	15	15	15	15	

Contact a local ABB Sales Office

¹ Contact a local ABB Sales Office

Speed range (continued)

PERCENTAGE ADDITION TO BASIC MOTOR PRICE FOR EXTENDED FIELD RANGE ON DC MOTORS RATED 500 VOLT ARMATURE, WINDER DUTY IN DPG/DPG-FV ENCLOSURE.																
Base Speed	Max. Speed By Field Control	Horsepower – 500 Volt Armature														
		Power Code A or C														
		7-1/2	10	15	20	25	30	40	50	60	75	100	125	150	200	250
650	1950	10	10	10	10	10	10	10	10	10	10	10	10	10	10	10
	2300	20	20	20	20	20	20	20	20	20	20	20	30	10	10	15 15 (2200)
	2400	20	20	20	20	20	20	20	20	20	20	20	—	15	15	20 20
	2600	20	20	20	20	20	20	20	25	20	20	20	—	20	20	— —
500	2000	10	10	10	10	10	10	—	—	—	10					
	2300	20	20	20	20	20	20	—	—	—	20					
	2400	20	20	20	20	20	20	—	—	—	20					
400	1200	0	0	0	0	0	0	—	—	—	—					
	1600	10	10	10	10	10	10	—	—	—	—					
	2000	20	20	20	20	20	20	—	—	—	—					
	2300	20	20	30	30	30	30	—	—	—	—					
	2400	30	30	30	30	30	30	—	—	—	—					
300	900	0	0	0	0	0	0	—	—	—	—					
	1200	10	10	10	10	10	10	—	—	—	—					
	1500	20	20	20	20	20	20	—	—	—	—					
	1800	25	25	25	25	25	25	—	—	—	—					

Contact a local ABB Sales Office

Technical data

Data Transmittal, Certified Dimension Sheets, Connection Diagrams & Performance Data – When requested at the time of order entry, ABB will provide an electronic copy via E-mail, of a software package for each order containing: Data Transmittal, Certified Dimension Sheet, Connection Diagram & Performance Data at NO CHARGE. E-mail address must be provided at time of order entry.

- Performance Data is calculated and includes motor horsepower, speed, torque & efficiency as a function of armature current up to 150 percent of rated armature current. Standard motor is rated for 150 percent current for one minute. The data is presented in both tabular and graphical format. In addition, performance data includes a speed curve showing variation of speed and generated counter-emf with shunt field current for both no load and full load conditions. Values of field resistance and inductance are included.
- For paper copies of the software package.
- For reproducible copies of the software package.

Note: Wiring diagrams showing the internal winding connections of the motor are not normally required by the customer and are not supplied as part of the order. Motor repair or service work requiring a wiring diagram, should be done by a Baldor-Reliance authorized service center.

- Instruction Manual – An instruction manual is supplied at no charge with each motor shipment. When requested at the time of order entry, ABB will provide an electronic copy via E-mail at no additional charge. E-mail address must be provided at time of order entry.
- For paper copies of instruction manual.

—

Tests**IMPORTANT – ALL PRICES FOR TESTS ARE NET**

Routine Test – Certified copy of Test Report – This modification provides up to five (5) copies of the certified test report containing the data on the standard routine test per IEEE Standard 113 that is given each motor. This test provides assurance that the motor meets design specifications. The routine test consists of:

1. Neutral check
2. Shunt field wiring resistance check
3. Commutation check
4. High potential check
5. Motor operation under following conditions with speed, voltage and current checked
 - a. No load at rated voltage at base speed and maximum field weakened speed
 - b. Full load at rated voltage at base speed and maximum field weakened speed

Note: All motors are subjected to routine test; however test data is not recorded and submitted to customer unless this modification is specified.

Witnessed Routine Test – The routine test described above to be witnessed by customer. Customer will be notified approximately 2 days before motor is ready for test. Includes six certified copies of test report.

Performance Test – Provides complete motor performance test and heat run on dynamometer with motor horsepower, speed, torque and efficiency recorded as a function of armature current up to 150% of rated armature current. Includes six certified copies of test report.

Witnessed Performance Test – Performance test witnessed by customer. Customer will be notified approximately 2 days before motor is ready for test. Includes six certified copies of test report.

Noise Test (No load) – This modification covers a broadband noise test conducted at a ABB facility. Measurements will be at five points, with two of the points 3 ft. from each side, one point 3 ft. from the back end and one point 3 ft. from the front end with all points on a horizontal plane "D" inches above the base where "D" is equal to the NEMA shaft center height. The 5th point will be 3 ft. from the top of the motor. Motor will be operating at base speed from a power supply as specified on the order. Modification covers testing and five copies of certified test reports.

Note: This modification covers testing of the motor only and does not provide a guarantee that the motor will meet a specified noise level since motor noise is dependent on the acoustical characteristics of the installation. The noise level at the customer's installation may be different than the value measured by this test.

• Combination motor and drive tests require pricing in addition to prices listed above. Contact a local ABB Sales Office for pricing.

Thermal protection

Thermal protection of the various windings in a direct-current motor, especially the armature winding which rotates, is considerably complex. The wide range of load and speed (ventilation) in the typical direct-current motor application adds to the difficulty. Current-sensing devices located remotely from the motor (frequently in control panels) cannot match the thermal characteristics of direct-current motors over a wide speed range because of these variable motor cooling conditions. ABB offers several modifications to protect the DC motor against overtemperature operation. (Refer to each modification for complete description and limitations.)

Available Modifications	Application
High limit thermostat on intercoil	Minimum protection recommended. See Mod. For limitations.
Warning thermostat on intercoil	Useful as a warning signal that motor is approaching maximum temperature. Time between actuation of "WARNING" thermostat and "HIGH LIMIT" thermostat depends on operating conditions and cannot be predetermined.
Air pressure switch	Recommended for all forced-vent, separate-vent, and totally enclosed dual cooled motors to give immediate indication of reduction in air flow.
Thermistors on intercoil	Provides protection similar to thermostat but generally gives better indication of winding temperature since, being a smaller device, it can make better thermal contact with the windings. Requires separate control module.
Thermistors on main field winding	Gives indication of excessive field heating that may be caused by high field supply voltage, loss of cooling air or operation of DPG and TEFC motors at low speed, high armature current conditions. Requires separate control module.
Resistance temperature detector on intercoil or field winding	When used with separate instrument, provides analog indication of intercoil temperature. Recommended on large motors in conjunction with thermostat or thermistors.

Modification

High limit thermostat on intercoil	Complete with leads brought in to the standard conduit box. The thermostat normally closed contact is suitable for use in control circuits rated 120 - 500 volts AC, 1100 volt-amps for DC180ATZ through C440ATZ frames and 110 - 600 volts AC.
------------------------------------	---

Protects against:

- High load, extremely low speed operation of DPG and TEFC motors.
- High load operation of TENV motors.
- High load operation of DPG-FV motors at all speeds except very low speeds.
- Operation in extremely high ambient temperatures.
- After a time delay, gives indication of complete loss of cooling air.

Advantages

- Low cost.
- Operates directly into control circuit.

Disadvantages

- Size of unit makes placement of winding critical to obtain good thermal contact.
- Since intercoil thermal time constant is typically five times longer than the armature thermal time constant, extremely high short-term armature overloads may damage the armature before the thermostat trips or permit the motor to be operated at higher than normal rated temperature rise resulting in less than normal motor insulation life. Other load limiting devices in the control-thermal overload relays or instantaneous over-current relays, must be used to protect the motor.
- Does not provide dependable protection on DPG and TEFC motors with overloads at low motor speeds. At low speeds, the heat dissipating ability of the armature is reduced due to decrease in armature velocity while the heat dissipating ability of the stationary intercoil, where the thermostat is located, remains constant.

Modification

High limit thermostat on intercoil	Use in conjunction with High Limit Thermostat. Provides low temperature thermostat on the intercoil with leads brought into the standard conduit box. This thermostat, selected to trip at approximately 15-C below the high limit thermostat, may be used as a warning signal to indicate the intercoil temperature is approaching a high temperature. Under certain operating conditions -- extremely low speed operation of force ventilated motor or extremely high short-term overloads -- the motor may be damaged before the high limit thermostat trips. If the condition of the overload is determined to be due to these operating conditions, the tripping of the warning thermostat should be used to shut down the drive, thus preventing possible damage to the motor by continued operation. In actual operation, the exact cause of the low temperature thermostat tripping may be difficult to determine, although tripping of this warning thermostat can be used as a signal to check drive operation.
------------------------------------	---

Note: The usefulness of a warning thermostat is limited since the time between activation of the warning thermostat is a function of load, ambient temperature, and other factors, and cannot be predetermined.

Thermal protection (continued)

Modification	
High Limit Thermostat on Field Coil	Complete with leads brought in to the standard conduit box. The thermostat normally closed contact is suitable for use in control circuits rated 120 - 500 volts AC, 1100 volt-amperes for DC180ATZ through C440ATZ frames and 110 - 600 volts AC. This option is recommended when a field regulator is used on the control.
Warning Thermostat on Field Coil	Provides low temperature thermostat on the field coil with leads brought into the standard conduit box. This thermostat, selected to trip at approximately 15-C below the high limit thermostat, may be used as a warning signal to indicate the field coil temperature is approaching a high temperature. Under certain operating conditions -- extremely low speed operation of force ventilated motor or extremely high short-term overloads -- the motor may be damaged before the high limit thermostat trips. If the condition of the overload is determined to be due to these operating conditions, the tripping of the warning thermostat should be used to shut down the drive, thus preventing possible damage to the motor by continued operation. In actual operation, the exact cause of the low temperature thermostat tripping may be difficult to determine, although tripping of this warning thermostat can be used as a signal to check drive operation.
High Limit Thermistors	Quantity 2) Mounted on intercoil.
Warning Thermistors	Quantity 2) Mounted on intercoil.
Control Module for use with Thermistors	Baldor-Reliance P/N 418033-14B (S/N 115101-2) supplied in a NEMA 12 enclosure for separate mounting. Requires 120 volt, 50/60Hz single phase 5 ampere unit. Provides two Triac outputs -- one normally energized and one normally off -- each rated 5 amperes continuous. Add for unmounted control module, 1,508 list.
(Quantity 2) mounted on intercoil with four leads brought into standard conduit box.	
Offers the same functional protection as a thermostat, but with the advantage of a smaller solid state sensing device to obtain better thermal contact with windings. The PTC thermistor bonded to the intercoil provides an approximate 20:1 increase in resistance when it reaches its trip temperature. This change in resistance is detected by an electronic module external to the motor having two Triac outputs -- one normally energized and one normally off -- each capable of switching 5 amps at 120 or 240 volts, 50/60Hz. These outputs can be used as a warning signal or in the drive control circuit, to shut down the drive and remove field power in an orderly manner.	
High Limit Thermistors	(Quantity 2) Mounted on main field winding.
Warning Thermistors	(Quantity 2) Mounted on main field winding.
Control Module for use with Thermistors	P/N 418033-14B (S/N 115101-2) supplied in a NEMA 12 enclosure for separate mounting. Requires 120 volt, 50/60Hz single phase 5 ampere unit. Provides two Triac outputs -- one normally energized and one normally off -- each rated 5 amperes continuous.
Quantity 2) on field winding.	
Additional protection can be obtained by monitoring main field winding temperature with thermistors. Possible causes of excessive field temperatures are as follows:	
<ul style="list-style-type: none"> • Loss of cooling air on motors designed for forced ventilation as standard. • High field voltage over 110% rated. • Operation of a DPG self-ventilated motors at low speeds. Although the fields of DPG self-ventilated motors are capable of continuous excitation at rated field voltage with no armature power applied, they may reach an excessive temperature when the armature is rotating at low speed, at high current, due to increased heat transfer from the armature to the field. 	
The PTC thermistor bonded to the field winding provides an approximate 20:1 increase in resistance when it reaches its trip temperature. This change in resistance is detected by an electronic module external to the motor having two Triac outputs -- one normally energized and one normally off -- each capable of switching 5 amps at 120 or 240 volts, 50/60Hz. These outputs can be used as a warning signal or in the drive control circuit, to shut down the drive and remove field power in an orderly manner.	
Resistance Temperature Detector (RTD)	This modification provides a 3-wire Resistance Temperature Detector mounted on the intercoil or field coil winding with leads wired to a terminal board in an auxiliary conduit box (included with this mod.) to permit monitoring the intercoil winding temperature with a customer supplied instrument giving an analog indication of intercoil thermal rise. This information is useful in checking intercoil temperature; however, the same limitations on relating this temperature to actual temperature apply with an RTD as with a thermostat.
10 ohm Copper	
100 ohm Platinum	
120 ohm Nickel	
IMPORTANT: Explosion proof motors (UL listed) must have a thermostat added when RTD is specified. Refer to ABB for availability of RTD on motors requiring CSA approval (CSA monogram).	
Bearing RTD	
10 ohm Copper	
100 ohm Platinum	For 3-wire RTD mounted on the bearing housing with leads wired to a terminal board in an auxiliary conduit box (included with this mod.).
120 ohm Nickel	

—

Vertical lifting**Modification**

Vertical Lifting Provisions	Provides provision for vertical lifting.
-----------------------------	--

—

Voltage**Modification**

Voltage - Special Armature 1 20 or 1 25 Volts	Provides either 120 or 125 V armature on ratings 1 thru 40 Hp. Frame may differ from standard. Armature choke may be required and is not included in price for motor operated on Power Code E or 3/3-240. Refer to the Special Voltage Power Supply modification. For other voltages, consult a local ABB Sales Office.
Voltage, Special Power Supply- S3R-	Provides motor suitable for operation on power supply Code E or regenerative power S3R (3/3-480-60-0), with 240 volts armature for motors rated 1/2 thru 75 Hp. Armature choke will not be required if field weakened speed range does not exceed 2.5 to 1, and maximum speed does not exceed 2500 rpm.

—

Warranty**Modification**

36 Month Extended Gold Seal	36 month extended Gold Seal Limited warranty covers any defect in workmanship for an additional 12 months over the standard product warranty. Does not cover failure from lack of preventative maintenance or misapplication.
-----------------------------	---



ABB Motors and Mechanical Inc.

5711 R.S. Boreham, Jr. Street

Fort Smith, AR 72901

Ph: 1.479.646.4711

new.abb.com/motors-generators