

WILLIAMS®

WORK TOOLS





INNOVATING FOR 140 YEARS

Williams has made strong, trusted tools for Industrial professionals since 1882. Due to their precise manufacturing process, Williams' products were used in the countless industrial shops of 19th century America.

From innovative products that helped make us famous, like Superrench[®], Supersocket[™], and Supertorque[™] we're carrying on the tradition of forging top-quality tools that hard-working people depend on.

Today with world-class factories across the United States, Williams' heritage of high-quality, industrial-focused tools continues to deliver a brand of tools that is ready to work.

EXPERIENCE MATTERS

At Williams, we believe selling a product is more than an exchange of tools. When you work with Williams, you work with industrial tool professionals whose experience in the field and the factory help you make smart decisions for your business.

With demanding timelines, unusually tough conditions and many other obstacles businesses face today, it is important to partner with a company that understands your challenges.

Williams and our distributors are here to help you find the right solutions for your individual business. Williams has a network of professionals with knowledge you can count on.



TRUSTED. STRONG. VALUED.

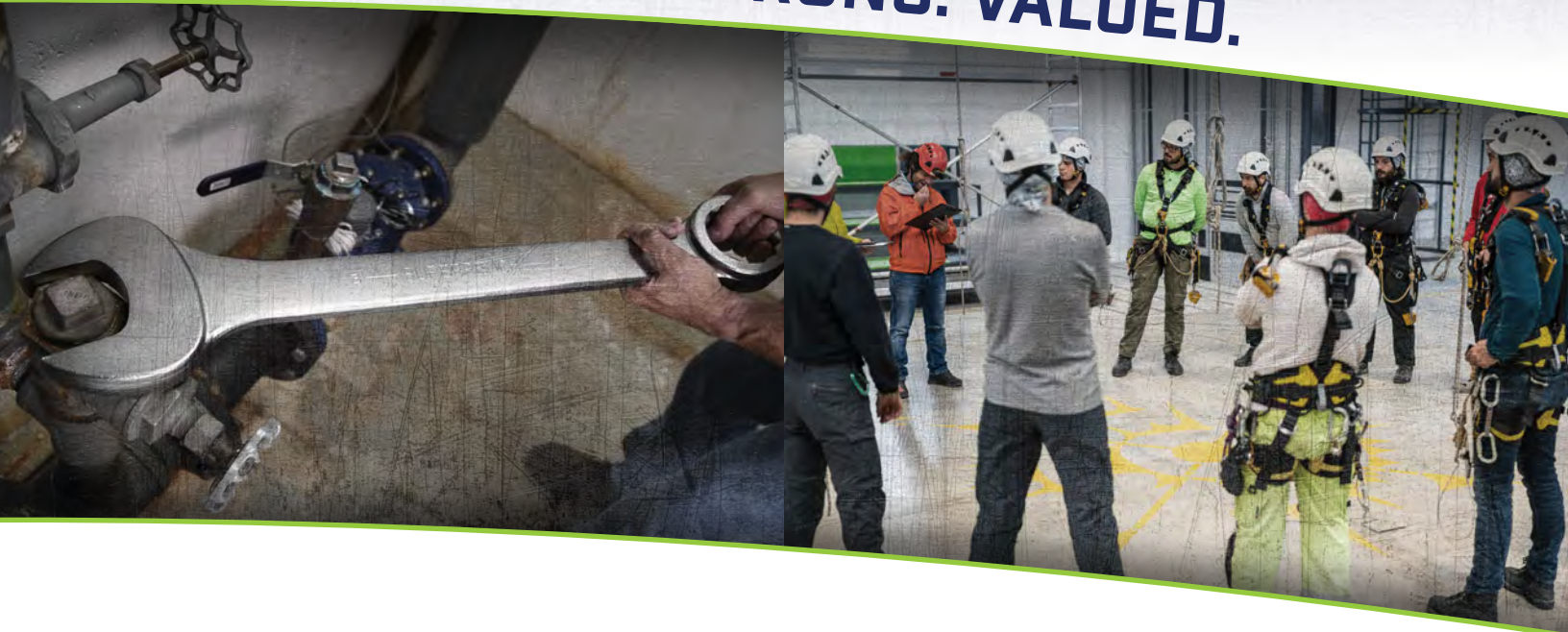

BUILT FOR INDUSTRIAL APPLICATIONS

Our growing assortment includes tools that are engineered to withstand demanding needs of industrial environments. Where the hard work is done, and steel strength is essential.

Williams' special blend of steel allows for a higher heat treat than average steel. This means each tool gets just the right hardness, toughness and strength for industrial applications.

And we know how to make great tools. Williams tools keep factories running safely and efficiently. They build and maintain ships. They keep power generation plants and oil production flowing and so much more. With 8,000+ tools in our portfolio, you will find the right tools to get the job done.

UNDERSTANDING WORK

With almost 140 years of experience, people trust Williams to design and manufacture tools that are safe, strong and reliable.

We know that keeping your people safe is the top priority. That's why we offer not just the safest products in the business, but the training and instruction on how to use them properly.

Our training programs help tool users learn about dangers involving misused, modified, and poorly maintained tools and how to determine the right tool for any and every job. In addition, we teach importance of ergonomics, tethered tools, proper calibration and more.





QUICK REFERENCE

5-34

MASTER SETS

35-54

TOOL STORAGE

55-76

TORQUE TOOLS

77-138

TOOLS@HEIGHT

139-188

WRENCHES

189-326

SOCKETS AND DRIVE TOOLS

327-342

SCREWDRIVERS

343-370

PLIERS, CLAMPS AND PIPE TOOLS

371-386

HAMMERS, PUNCHES, CHISELS AND PRYBARS

387-422

INDUSTRIAL HYDRAULICS

423-504

TOOLS FOR THE TRADES

505-518

INSULATED TOOLS

519-522

CONVERSION CHART / SAFETY ICONS

523-554

INDEX

MASTER SETS

TOOLS@HEIGHT SETS	8
MAMMOTH TOOL SET	16
MEGA TOOL SET	18
MAXXUM TOOL SET	20
MAINTENANCE SERVICE SET	24
OIL FIELD SERVICE SET	29
GENERAL MAINTENANCE SET	31
ELECTRICAL MAINTENANCE SET	33



SETS DEVELOPED WORKING SIDE BY SIDE WITH INDUSTRY PROFESSIONALS

- Whatever the industry, Williams® Master Tool Sets will keep your equipment and assets working at peak performance
- Sets available in various formats and sizes to meet the specific needs of your application
 - Electrical Maintenance Sets
 - General Maintenance Sets
 - Heavy Duty Maintenance Sets
 - Oilfield Tool Sets
 - Mechanical Maintenance Sets
 - Technicians Service Sets
 - Tools@Height™ Sets
- Tackle increasingly complex maintenance tasks with Williams® Master Tool Sets
- A full complement of hand tools
- Get your work done faster, easier and safer
- Tool Storage Included



MASTER SETS

PROVIDING YOU WITH THE RIGHT TOOLS FOR YOUR SPECIFIC TASKS





TOOLS@HEIGHT MASTER MAINTENANCE TOOL SET

Contains the following tools:

Product Category	Product Category
Adjustable & Miscellaneous Wrenches	Miscellaneous Tools
Combination, Box, & Open End Wrenches	Pliers
Hammers	Pry Bars, Punches & Chisels
Hand Sockets, Ratchets, & Accessories	Screwdrivers & Nut drivers
Hex Keys & Sockets	Tool Storage
Impact Sockets & Accessories	Tools@Height Tethers, Lanyards, & Specialties

Set Configurations Available

Product Code	Description
JHWSC409THB	Complete Tools@Height Master Maintenance Tool Set With Tool Boxes
JHWSC409TH	Complete Tools@Height Master Maintenance Tool Set Only

Tool Boxes Included

Product Code	Description
JHWW40TC4	40" Wide x 20" Deep 4 Drawer Top Chest
JHWW40RC7	40" Wide x 20" Deep 7 Drawer Tool Cabinet

Features

- The Tools@Height Master Maintenance set provides a great assortment of tools for all types of maintenance applications
- All tools are designed to be used with our tethering and retention systems which maintain or enhance the tools' functionality when used at height or near critical assemblies
- Productivity and safety right out of the box
- Many applications - any industry where a dropped tool could harm personnel, damage machinery or cost production time
- High level uses - drilling derricks, wind turbines, cranes, buildings, bridges, masts, powerlines, hangars, scaffold builders
- Low level uses - stop tools dropping onto flight hardware, into engines, machinery, food production lines, vats, mine shafts, even under water uses
- Set is available with foamed tool control drawers on a special order basis
- Tools@Height sets contain an assortment of pouches and lanyards designed for use with a suitable belt such as the Comfort and Utility belts on page 96

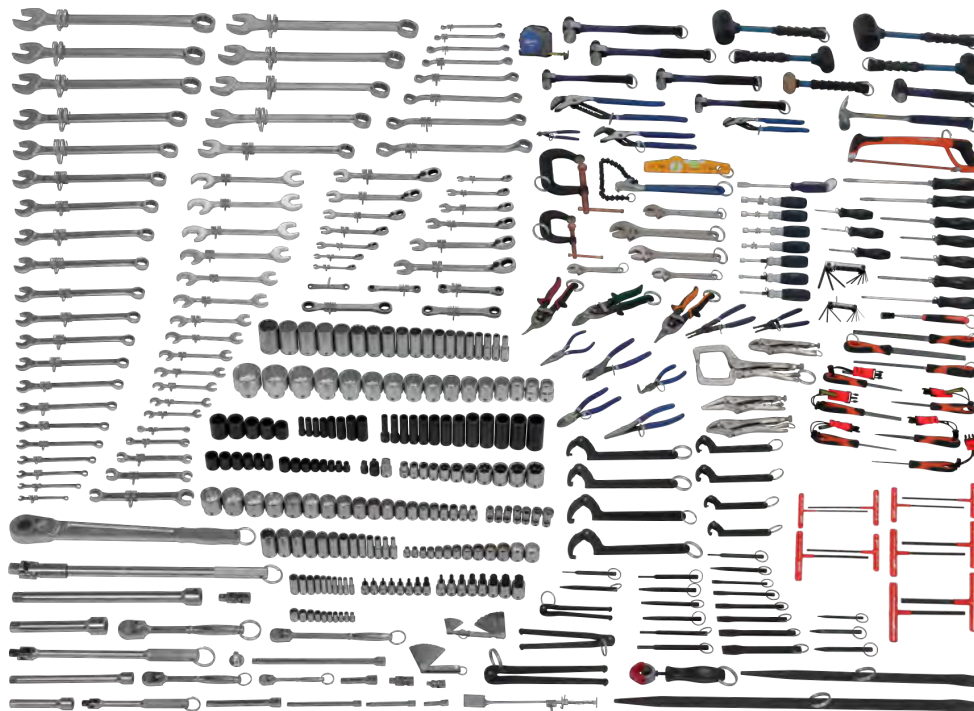

JHWSC409TH



JHWW26TC4



JHWW26RC7

TOOLS@HEIGHT INTERMEDIATE MAINTENANCE SERVICE SET

Contains the following tools:

Product Category	Product Category
Adjustable & Miscellaneous Wrenches	Miscellaneous Tools
Combination, Box, & Open End Wrenches	Pliers
Hammers	Pry Bars, Punches & Chisels
Hand Sockets, Ratchets, & Accessories	Screwdrivers & Nut drivers
Hex Keys & Sockets	Tool Storage
Impact Sockets & Accessories	Tools@Height Tethers, Lanyards & Specialties

Set Configurations Available

Product Code	Description
JHWSC225THB	Complete Tools@Height Intermediate Tool Set With Tool Boxes
JHWWSC225TH	Complete Tools@Height Intermediate Tool Set Only

Tool Boxes Included

Product Code	Description
JHWW26TC4	26" Wide x 20" Deep 4 Drawer Top Chest
JHWW26RC7	26" Wide x 20" Deep 7 Drawer Tool Cabinet

Features

- The Tools@Height Intermediate Maintenance set provides a full complement of tools
- All tools are designed to be used with our tethering and retention systems which maintain or enhance the tools' functionality when used at height or near critical assemblies
- Productivity and safety right out of the box
- Many applications - any industry where a dropped tool could harm personnel, damage machinery or cost production time
- High level uses - drilling derricks, wind turbines, cranes, buildings, bridges, masts, powerlines, hangars, scaffold builders
- Low level uses - stop tools dropping onto flight hardware, into engines, machinery, food production lines, vats, mine shafts, even under water uses
- Set is available with foamed tool control drawers on a special order basis
- Tools@Height sets contain an assortment of pouches and lanyards designed for use with a suitable belt such as the Comfort and Utility belts on page 96



JHWSC225TH



TOOLS@HEIGHT GENERAL MAINTENANCE SERVICE SET

Contains the following tools:

Product Category	Product Category
Adjustable & Miscellaneous Wrenches	Pliers
Combination, Box, & Open End Wrenches	Pry Bars, Punches & Chisels
Hammers	Screwdrivers & Nut drivers
Hand Sockets, Ratchets, & Accessories	Tool Storage
Hex Keys & Sockets	Tools@Height Tethers, Lanyards, & Specialties
Miscellaneous Tools	

Set Configurations Available

Product Code	Description
JHWSC116HTB	Complete Tools@Height General Service Tool Set With Tool Box
JHWWSC116TH	Complete Tools@Height General Service Tool Set Only

Tool Boxes Included

Product Code	Description
JHW50950B	32" Wide x 19" Deep Job Site Box

Features

- The Tools@Height General Maintenance Service set provides a solid complement of tools
- All tools are designed to be used with our tethering and retention systems which maintain or enhance the tools' functionality when used at height or near critical assemblies
- Productivity and Safety right out of the box
- Many applications - any industry where a dropped tool could harm personnel, damage machinery or cost production time
- High level uses - drilling derricks, wind turbines, cranes, buildings, bridges, masts, powerlines, hangars, scaffold builders
- Low level uses - stop tools dropping onto flight hardware, into engines, machinery, food production lines, vats, mine shafts, even under water uses
- Set is available with foamed tool control drawers on a special order basis
- Tools@Height sets contain an assortment of pouches and lanyards designed for use with a suitable belt such as the Comfort and Utility belts on page 96



JHW50950B



JHWWSC116TH



TOOLS@HEIGHT BASIC MAINTENANCE SERVICE SET

Contains the following tools:

Product Category	Product Category
Adjustable & Miscellaneous Wrenches	Miscellaneous Tools
Combination, Box, & Open End Wrenches	Pliers
Hammers	Pry Bars, Punches & Chisels
Hand Sockets, Ratchets, & Accessories	Screwdrivers & Nut drivers
Hex Keys & Sockets	Tools@Height Tethers, Lanyards, & Specialties

Set Configurations Available

Product Code	Description
JHWWSC-72-TH	Complete Tools@Height Basic Maintenance Tool Set in Safe Bucket

Features

- Furnished in Safe Bucket for easy portability
- Safety right out of the box
- The Tools@Height Basic Maintenance set provides a good start to a Tools@Height tool program
- All tools are designed to be used with our tethering and retention systems which maintain or enhance the tools' functionality when used at height or near critical assemblies
- Many applications - any industry where a dropped tool could harm personnel, damage machinery or cost production time
- High level uses - drilling derricks, wind turbines, cranes, buildings, bridges, masts, powerlines, hangars, scaffold builders
- Low level uses - stop tools dropping onto flight hardware, into engines, machinery, food production lines, vats, mine shafts, even under water uses
- Williams' Tools@Height sets contain an assortment of pouches and lanyards designed for use with a suitable belt
- An assortment of Comfort and Utility belts can be found on page 96
- The full assortment of Tools@Height lanyards, tethers, and other accessories is on pages 91 through 97



JHWWSC-72-TH



TOOL@HEIGHT STARTER PLUS SET

Contains the following tools:

- Product Category
- Adjustable Wrenches
- Combination Wrenches
- File
- Hammer
- Hand Sockets, Ratchets & Accessories
- Pick up Tool
- Pliers
- Screwdriver
- Tape Measure
- Tools@Height Tethers, Lanyards & Specialties
- Grand Total

Set Configurations Available

Product Code	Description
WSC-45-TH	Complete Tools@Height Starter Set in Safe Bucket

Features

- The ideal way to start a drop prevention program
- Use where dropped tools can harm personnel, damage components, or cause down time
- Excellent assortment of basic hand tools for most maintenance applications
- Furnished in Safe Bucket for easy portability



WSC-45-TH

TOOL@HEIGHT STARTER SET

Contains the following tools:

- Product Category
- Adjustable Wrenches
- File
- Hammer
- Pick up Tool
- Pliers
- Screwdriver
- Tape Measure
- Tools@Height Tethers, Lanyards & Specialties

Set Configurations Available

Product Code	Description
JHWWSC-27-TH	Complete Tools@Height Starter Set in Safe Bucket

Features

- Ideal for general maintenance work in the factory or job site
- All tools are designed to be used with our tethering and retention systems which maintain or enhance the tools' functionality when used at height or near critical assemblies.
- Includes tools and assortment of pouches and lanyards designed for use with a suitable belt.
- Williams' Tools@Height sets contain an assortment of pouches and lanyards designed for use with a suitable belt
- An assortment of Comfort and Utility belts can be found on page 96
- The full assortment of Tools@Height lanyards, tethers, and other accessories is on pages 91 through 97



JHWWSC-27-TH





KWTIWWKIT

TOOLS@HEIGHT IRONWORKER'S TOOLKIT

Contains the following tools:

Product Category	Product Category
Pliers	Hammer
Adjustable Construction Wrench	Measuring Tape
Structural Wrench	Tools@Height Tethers, Lanyards & Specialties
Bull Pin	

Set Configurations Available

Product Code	Description
KWTIWWKIT	Ironworker's Tool Kit

Features

- All tools are designed to be used with our tethering and retention systems which maintain or enhance the tools' functionality when used at height or near critical assemblies
- Tool Kit includes the tools, tethers, lanyards needed for ironworkers to work at height



KWTBM

TOOLS@HEIGHT BOILMAKER'S TOOL KIT

Contains the following tools:

Product Category	Product Category
Pliers	Torpedo Level
Adjustable Construction Wrench	Hammer
Open End Structural Wrench	Measuring Tape
Bull Pin	Tools@Height Tethers, Lanyards & Specialties

Set Configurations Available

Product Code	Description
KWTBM	Boilmaker's Tool Kit

Features

- All tools are designed to be used with our tethering and retention systems which maintain or enhance the tools' functionality when used at height or near critical assemblies
- Tool Kit includes the tools, tethers, lanyards needed to keep boilermakers safe and productive while working at height



KWTHRSGHR

TOOLS@HEIGHT HRSG HIGH RIGGING TOOLKIT

Contains the following tools:

Product Category	Product Category
Pliers	Hammer
Adjustable Construction Wrench	Measuring Tape
Open End Structural Wrench	Sleever Bar
Bull Pin	Tools@Height Tethers, Lanyards & Specialties
Torpedo Level	

Set Configurations Available

Product Code	Description
KWTHRSGHR	HRSG High Rigging Toolkit

Features

- All tools are designed to be used with our tethering and retention systems which maintain or enhance the tools' functionality when used at height or near critical assemblies
- Tool kit includes bull pin, sleever bars, wrenches, hammer, torpedo level, measuring tape and many more tools with attachment points along with the tethers and lanyards for working at height



TOOLS@HEIGHT PIPEFITTER'S FOREMAN'S TOOLKIT

Contains the following tools:

Product Category	Product Category
Combination Wrenches	Pinch Bar
Sockets	Hex Keys
Drive Tools	Tape Measure
Screwdrivers	Tool Box
Files	Pin Release Tool
Hammer	Tool Pouch

Set Configurations Available

Product Code	Description
KWTPFFOR	Pipefitter's Foreman's Toolkit

Features

- All tools are designed to be used with our tethering and retention systems which maintain or enhance the tools' functionality when used at height or near critical assemblies
- Pipefitter's Foreman's Tool kit includes sockets, drive tools, combination wrenches, screwdrivers and many more tools with attachment points for working at height



KWTPFFOR

TOOLS@HEIGHT INDIVIDUAL PIPEFITTER'S TOOLKIT

Contains the following tools:

Product Category	Product Category
Wedges	Adjustable Wrenches
Utility Superjoint Pliers	Measuring Tape
Side Cutters	Tools@Height Tethers, Lanyards & Specialties

Set Configurations Available

Product Code	Description
KWTPFIND	Individual Pipefitter's Toolkit

Features

- All tools are designed to be used with our tethering and retention systems which maintain or enhance the tools' functionality when used at height or near critical assemblies
- Individual Pipefitter's Tool kit includes wedges, pliers, side cutters, hammers, adjustable wrenches and many more tools with attachment points along with the tethers and lanyards for working at height



KWTPFIND

TOOLS@HEIGHT PIPEFITTER'S GANG BOX KIT

Contains the following tools:

Product Category	Product Category
Utility Superjoint Pliers	Chisels & Punches
Side Cutters	Ratchet
Adjustable Wrenches	Pipe Wrench
Measuring Tape	Plastic Tool Box
Hammers	

Set Configurations Available

Product Code	Description
KWTPFBOX	Pipefitter's Gang Box Kit

Features

- All tools are designed to be used with our tethering and retention systems which maintain or enhance the tools' functionality when used at height or near critical assemblies
- Pipefitter's Gang Box Kit includes pliers, hammer, adjustable wrenches and many more tools with attachment points for working at height



KWTPFBOX



TOOLS@HEIGHT INDIVIDUAL ELECTRICIAN'S TOOLKIT

Contains the following tools:

Product Category	Product Category
Pliers, Side Cutter & Crimper	Files
Screwdrivers	Superjoint Pliers
Adjustable Wrenches	Hammers
Chisels & Punches	Hex Key
Hacksaw Frame	Measuring Tape
Torpedo Level	Tools@Height Tethers, Lanyards & Specialties
Miscellaneous Tools	

Set Configurations Available

Product Code	Description
KWTELEKITM	Individual Electrician's Toolkit with S/M Comfort Belt
KWTELEKITL	Individual Electrician's Toolkit with L/XL Comfort Belt
KWTELEKITXL	Individual Electrician's Toolkit with 2X/3X Comfort Belt

Features

- All tools are designed to be used with our tethering and retention systems which maintain or enhance the tools' functionality when used at height or near critical assemblies
- The Individual Electrician's Toolkit contains an assortment of tools with engineered attachment points, tethers and lanyards designed to keep electrician's safe and productive while working at heights



KWTELEKITM

TOOLS@HEIGHT ELECTRICIAN CREW KIT

Contains the following tools:

Product Category	Product Category
C-Clamps	Pin Release Tool
Pliers	Sockets
Pipe Wrenches	Combination Wrenches
Files	Level
Hammer	Lift Bucket & Hardhat Lanyard Strap
Drive Tools	

Set Configurations Available

Product Code	Description
KWTELECWKT	Electrician's Crew Kit

Features

- All tools are designed to be used with our tethering and retention systems which maintain or enhance the tools' functionality when used at height or near critical assemblies
- The Electrician's Crew Kit contains an assortment of tools with engineered attachment points, tethers and lanyards designed to keep electrician's safe and productive while working at heights



KWTELECWKT



MAMMOTH TOOL SET

The largest tool set in the industry.
Contains the following tools:

Product Category	Product Category
Chisel and Punches	Miscellaneous Tools
Clamps	Pliers
Electrical Crimping Pliers	Prybars
Files	Ratchets, Drive Tools, and Accessories
Hammers	Saws and Saw Blades
Hand Sockets	Scrapers
Hex Keys	Screwdrivers
Holesaw Set	Snips
Impact Drive Tools	Tool Boxes
Impact Sockets	Torque Wrenches
Knives	Wrenches

Set Configurations Available

Product Code	Description
JHWMAMMOTHHM	Mammoth Tool Set with Metric Wrenches and Sockets Only
JHWMAMMOTHSAE	Mammoth Tool Set with Fractional Wrenches and Sockets Only
JHWMAMMOTH	Mammoth Tool Set Only
JHWMAMMOTHTB	Complete Mammoth Tool Set with Tool Boxes

Tool Boxes Included

JHWW40TC4	40" Wide x 20" Deep 4-Drawer Top Chest
JHWW40RC7	40" Wide x 20" Deep 7-Drawer Roll Cabinet
JHWW55TC10	55" Wide x 20" Deep 10-Drawer Top Chest
JHWW55RC11	55" Wide x 20" Deep 11-Drawer Roll Cabinet
JHW50721	3-Drawer Service Cart with Lid

Features

- It's better to have it and not need it than need it and not have it - and with this tool set, you're almost certain to have what you need. This set contains the tools to handle almost any job your shop is likely to see, in both fractional and metric sizes. It includes a comprehensive assortment of sockets, ratchets, and accessories in 1/4", 3/8", 1/2", and 3/4" drive, for both hand and impact use. A full complement of wrenches in a number of styles helps you tackle increasingly complex maintenance tasks. A comprehensive assortment of screwdrivers, pliers, hammers, punches and chisels, is there when you need them, and specialty items such as saws, scrapers, and other tools for industrial maintenance mechanics and tradesmen round out this truly Mammoth tool set.
- You'll want to keep your tools safe and secure, and our industry-leading Mammoth Tool Set includes the storage cabinets necessary to do that. Two top-chest / roll-cabinet combinations are included, as well as a rolling three-drawer tool cart. A total of 35 drawers and over 75,000 cubic inches of storage capacity will help you organize your tools effectively. And the mobile tool cart helps bring your tools to the job, where you need them.
- Whatever the industry, this set will help you keep your equipment and assets working, helping you compete more effectively. Get your work done faster, easier, and safer with the Mammoth Tool Set from Williams. All other tool sets are simply ordinary.



Professional industrial cabinets JHWW40RC7-JHWW40TC4 are also included in JHWMAMMOTHTB





JHWMAMMOTHTB



MEGA TOOL SET

A comprehensive assortment. Contains the following tools:

Product Category	Product Category	Product Category	Product Category
Chisel and Punches	Hand Sockets	Miscellaneous Tools	Scrapers
Clamps	Hex Keys	Pliers	Screwdrivers
Electrical Crimping Pliers	Impact Sockets	Prybars	Snips
Files	Impact Drive Tools	Ratchets, Drive Tools, and Accessories	Tool Boxes
Hammers	Knives	Saws and Saw Blades	Torque Wrenches

Set Configurations Available

Product Code	Description
JHWMEGAMM	Mega Tool Set with Metric Wrenches and Sockets Only
JHWMEGASAE	Mega Tool Set with Fractional Wrenches and Sockets Only
JHWMEGA	Mega Tool Set Only
JHWMEGATB	Complete Mega Tool Set with Tool Boxes

Tool Boxes Included

JHWW55TC10	55" Wide x 20" Deep 10-Drawer Top Chest
JHWW55RC11	55" Wide x 20" Deep 11-Drawer Roll Cabinet
JHW50721	3-Drawer Service Cart with Lid

Features

- The Mega Set contains a comprehensive assortment of tools, in both fractional and metric sizes. Includes an extensive assortment of sockets, ratchets, and accessories in 1/4", 3/8", 1/2", and 3/4" drive, for both hand and impact use. A full complement of wrenches in a number of styles helps you tackle increasingly complex maintenance tasks. Over 150 screwdrivers, pliers, hammers, punches and chisels, are included, and specialty items such as saws, scrapers, and other tools for industrial maintenance mechanics and tradesmen round out the Mega Set from Williams.
- Mega Set includes the tool storage cabinets necessary to organize your tools. A top-chest / roll-cabinet combination is included, as well as a rolling three-drawer tool cart. A total of 26 drawers and over 45,000 cubic inches of storage capacity will help you store your tools effectively. The mobile tool cart helps bring your tools to the job, where you need them.
- Get your work done faster, easier, and safer with the Mega Tool Set from Williams. All other tool sets are simply ordinary.





JHWMEGATB



MAXXUM TOOL SET

Contains the following tools:

Product Category	Product Category	Product Category	Product Category
Chisel and Punches	Hex Keys	Prybars	Tool Boxes
Clamps	Impact Sockets	Ratchets, Drive Tools, and Accessories	Torque Wrenches
Electrical Crimping Pliers	Impact Drive Tools	Saws and Saw Blades	Wrenches
Files	Knives	Scrapers	
Hammers	Miscellaneous Tools	Screwdrivers	
Hand Sockets	Pliers	Snips	

Set Configurations Available

Product Code	Description
JHWMAXXUMMM	Maxxum Tool Set with Metric Wrenches and Sockets Only
JHWMAXXUMSAE	Maxxum Tool Set with Fractional Wrenches and Sockets Only
JHWMAXXUM	Maxxum Tool Set Only
JHWMAXXUMTB	Complete Maxxum Tool Set with Tool Boxes

Tool Boxes Included

JHWW55TC10	55" Wide x 20" Deep 10-Drawer Top Chest
JHWW55RC11	55" Wide x 20" Deep 11-Drawer Roll Cabinet
JHW50721	3-Drawer Service Cart with Lid

Features

- The Maxxum Set contains a full complement of tools, in both fractional and metric sizes. It includes an assortment of sockets, ratchets, and accessories in 1/4", 3/8", and 1/2" drive, for both hand and impact use. Hand wrenches in a number of styles helps you tackle increasingly complex maintenance tasks. Over 100 screwdrivers, pliers, hammers, punches and chisels, are included, and specialty items such as saws, scrapers, and other tools for industrial maintenance mechanics and tradesmen round out the Maxxum Set from Williams.
- Maxxum includes the tool storage cabinets necessary to organize your tools. A top-chest / roll-cabinet combination is included, as well as a rolling three-drawer tool cart. A total of 26 drawers and over 35,000 cubic inches of storage capacity will help you store your tools effectively. The mobile tool cart helps bring your tools to the job, where you need them.
- Get your work done faster, easier, and safer with the Maxxum Tool Set from Williams. All other tool sets are simply ordinary.





JHWMAXXUM



MONSTER TOOL SET

Contains the following tools:

Product Category	Product Category	Product Category
Crowfoot Wrenches	Miscellaneous Tools	Screwdriver
Hacksaw Frame	Nut drive	Snips
Hammer	Pliers	Sockets, Ratchets, Drive Tools and Accessories
Hex Key	Prybars	Tape Measure
Knives	Punch & Chisels	Wrenches

Set Configurations Available

Product Code	Description
JHWMONSTER	Monster Tool Set Only
JHWMONSTERTB	Complete Monster Tool Set with Tool Boxes

Tool Boxes Included

JHWW55TC10	55" Wide x 20" Deep 10 Drawer Top Chest
JHWW55RC11	55" Wide x 20" Deep 11 Drawer Tool Cabinet

Features

- The Monster Set contains a full complement of tools, in both fractional and metric sizes. It includes an assortment of sockets, ratchets, and accessories in 1/4", 3/8" and 1/2" drive.
- Hand wrenches in a number of styles helps you tackle increasingly complex maintenance tasks. Also included are screwdrivers, pliers, hammers, punches and chisels, are included, and specialty items such as hacksaws, tape measure, and other tools for industrial maintenance mechanics and tradesmen round out this Master set from Williams.
- Includes the tool storage cabinets necessary to organize your tools. A top-chest /roll-cabinet combination is included.
- Get your work done faster, easier, and safer with this Monster Tool Set from Williams.
- Williams. All other tool sets are simply ordinary.



JHWW55TC10



JHWW55RC11

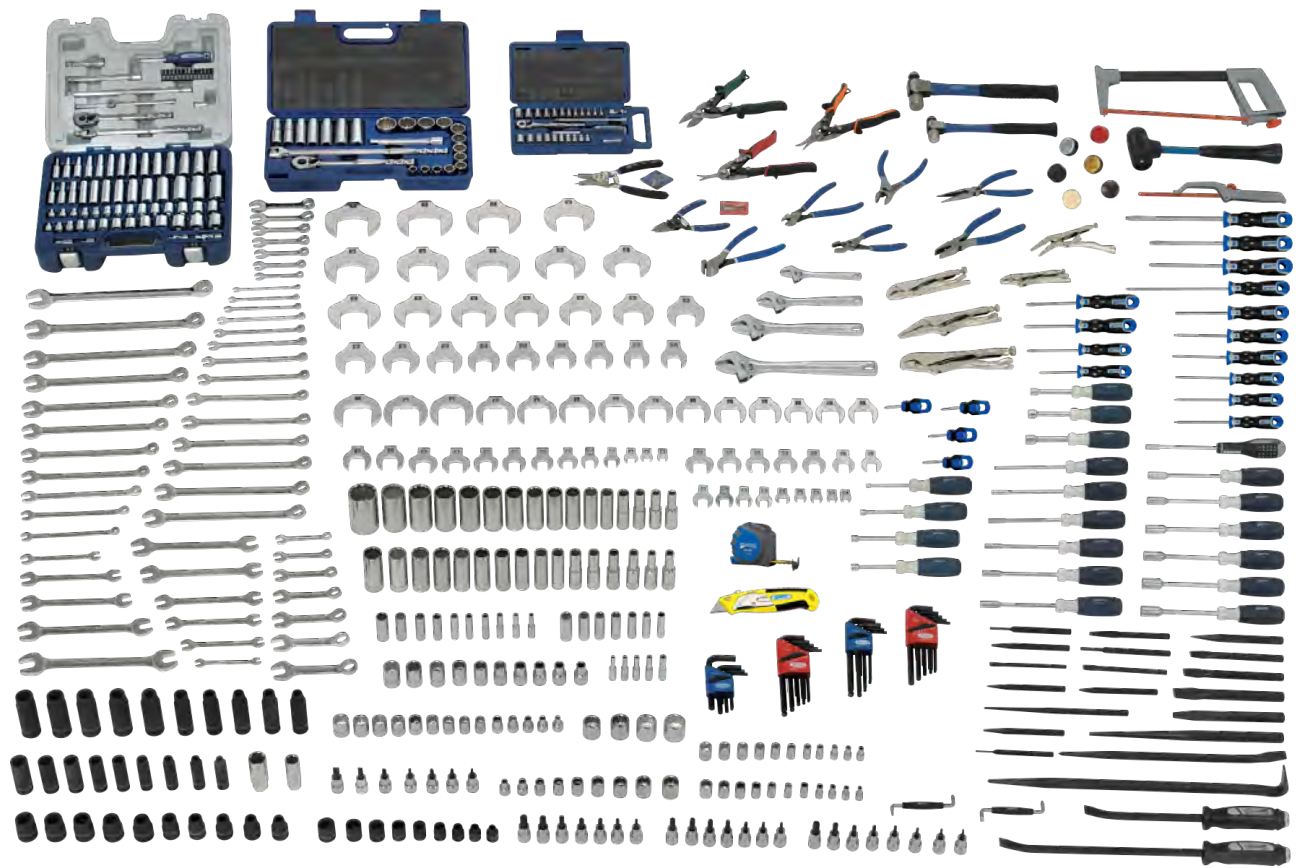

JHWMONSTER



MASTER MAINTENANCE TOOL SET

Contains the following tools:

Product Category	Product Category	Product Category	Product Category
Chisel and Punches	Hand Sockets	Pliers	Screwdrivers
Clamps	Impact Drive Tools	Ratchets, Drive Tools, and Accessories	Snips
Files	Impact Sockets	Saws and Saw Blades	Tool Boxes
Hammers	Miscellaneous Tools	Scrapers	Wrenches

Set Configurations Available

Product Code	Description
JHWMMASTER	Master Maintenance Tool Set Only
JHWMMASTERTB	Complete Master Maintenance Tool Set with Tool Boxes

Tool Boxes Included

JHWW40TC4	40" Wide x 20" Deep 4-Drawer Top Chest
JHWW40RC7	40" Wide x 20" Deep 7-Drawer Roll Cabinet

Features

- This set provides the tools necessary for most general service and repair applications
- Included are a wide variety of fractional wrenches, hand and impact sockets, and popular 1/4", 3/8" and 1/2" drive ratchets and accessories
- An assortment of professional industrial tools such as pliers, screwdrivers, hammers, punches, chisels, and other tools round out the offering





JHWW40TC4

JHWW40RC7

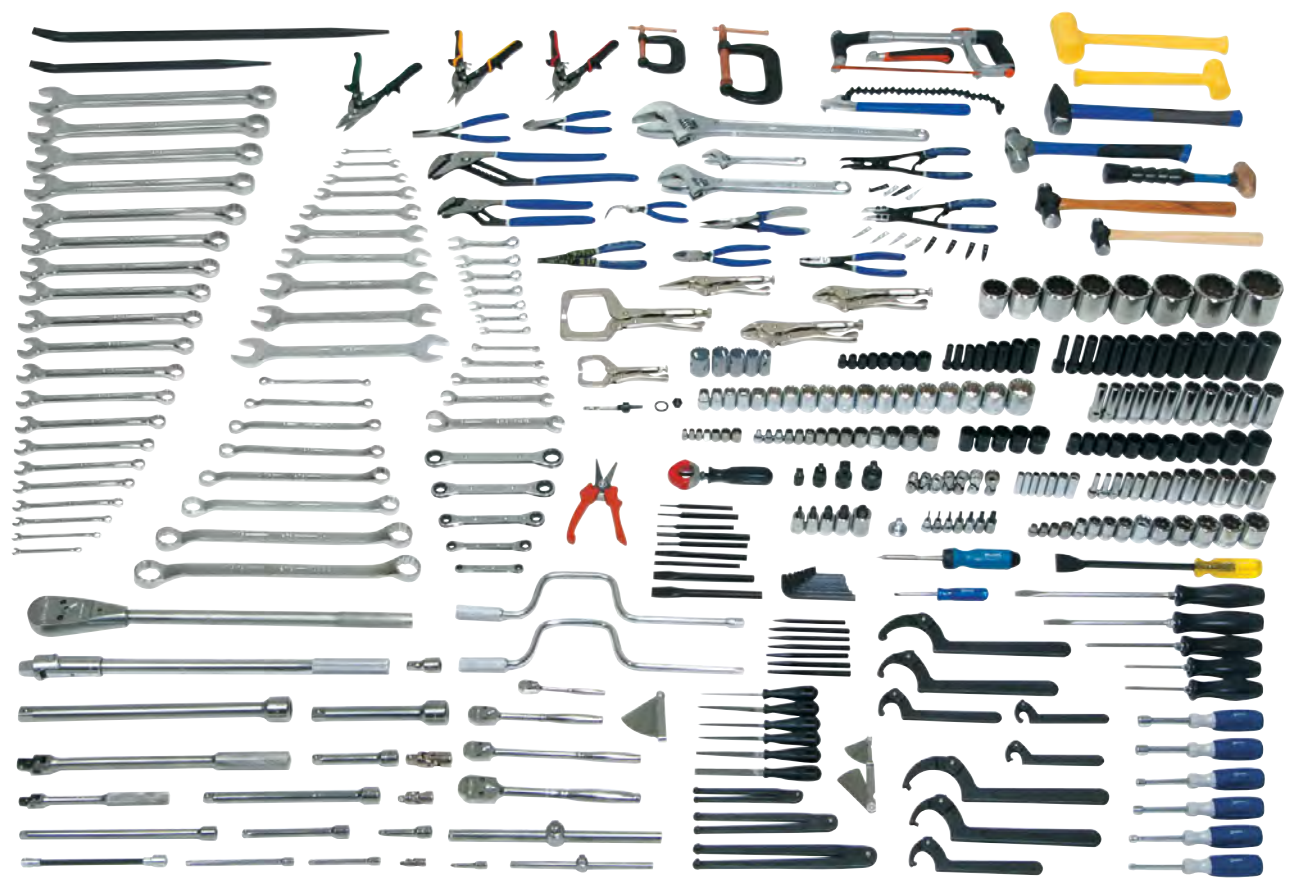

JHWMASER



INTERMEDIATE TECHNICIAN'S TOOL SET

Contains the following tools:

Product Category	Product Category
Chisel and Punches	Ratchets, Drive Tools, and Accessories
Extractor	Screwdrivers
Feeler Gauge	Hand Sockets
Files	Tape Measure
Hammers	Torque Wrenches
Hex Keys	Wrenches
Pliers	

Set Configurations Available

Product Code	Description
JHWMECMNT	Intermediate Technician's Tool Set Only
JHWMECMNTTB	Complete Intermediate Technician's Tool Set with Tool Boxes

Tool Boxes Included

JHWW40RC7	40" 4 Drawer Professional Top Chest
JHWW40TC4	40" 7 Drawer Professional Roll Cabinet

Features

- This set provides the tools necessary for many general service and repair applications
- Included are a variety of fractional wrenches, hand and impact sockets, and 1/4", 3/8" and 1/2" drive ratchets and accessories
- An assortment of professional industrial tools such as pliers, screwdrivers, hammers, punches, chisels, and other tools round out the offering

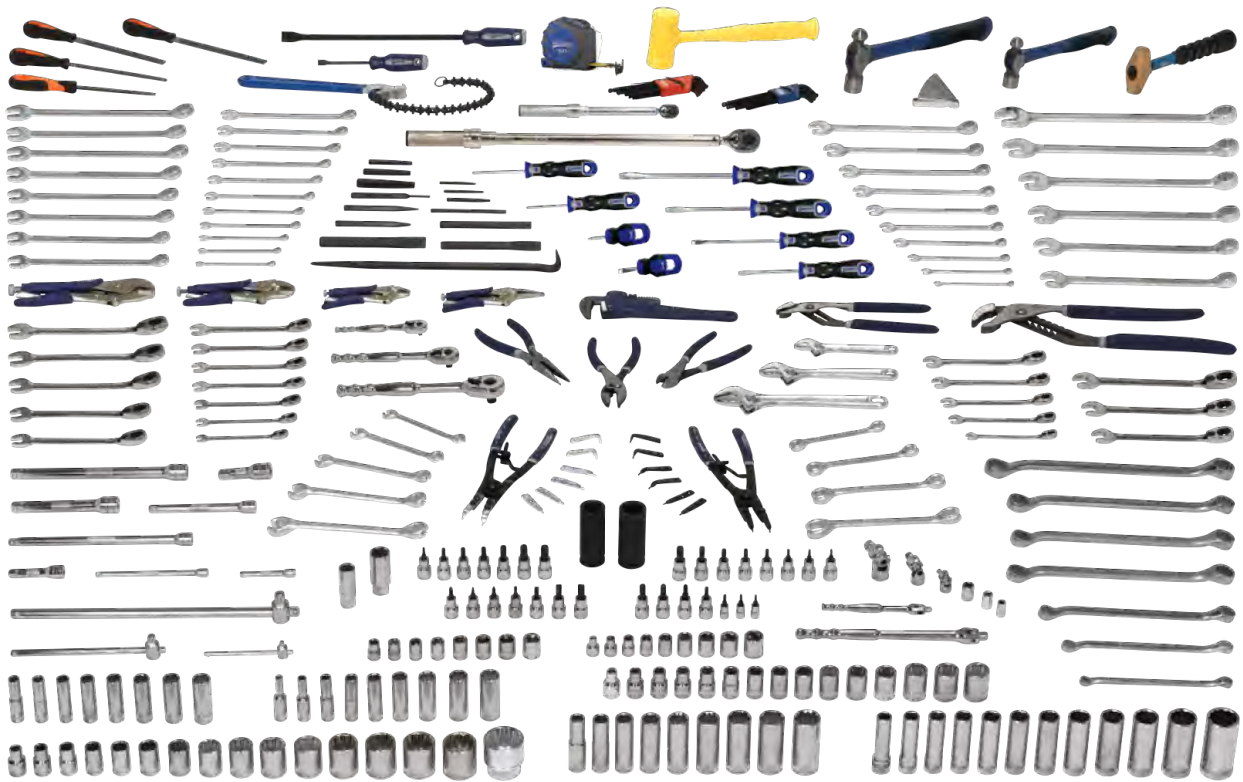

JHWMECMNT





JHWW40TC4

JHWW40RC7

ADVANCED MAINTENANCE SERVICE SET

Contains the following tools:

Product Category	Product Category
Chisel and Punches	Pliers
Files	Ratchets, Drive Tools, and Accessories
Hammers	Saws and Saw Blades
Hand Sockets	Screwdrivers
Impact Drive Tools	Tool Boxes
Impact Sockets	Wrenches
Miscellaneous Tools	

Set Configurations Available

Product Code	Description
JHWADVMT	Advanced Maintenance Service Tool Set Only
JHWADVMTTB	Complete Advanced Maintenance Service Tool Set with Tool Boxes

Tool Boxes Included

JHWW40TC4	40" Wide x 20" Deep 4-Drawer Top Chest
JHWW40RC7	40" Wide x 20" Deep 7-Drawer Roll Cabinet

Features

- This set provides the tools necessary for many general service and repair applications
- Included are a variety of fractional wrenches, hand and impact sockets, and 1/4", 3/8" and 1/2" drive ratchets and accessories
- An assortment of professional industrial tools such as pliers, screwdrivers, hammers, punches, chisels, and other tools round out the offering



JHWADVMT



PETROLEUM OIL FIELD SERVICE SET

Contains the following tools:

Product Category	Product Category
Chisels & Punch	Scraper
Haer	Screwdrivers
Pipe Wrenches	Sockets
Pliers	Utility Tools
Prybar	Wrenches
Ratchets, Drive Tools & Accessories	

Set Configurations Available

Product Code	Description
JHWPETROSET	Petroleum Oil Field Tool Set Only
JHWPETROSETTB	Complete Petroleum Oil Field Tool Set with Tool Boxes

Tool Boxes Included

JHWW40RC7	40" 4 Drawer Professional Top Chest
JHWW40TC4	40" 7 Drawer Professional Roll Cabinet

Features

- The set provides the tools necessary for Petroleum Oil field general service and repair applications
- Included are a wide variety of chisels, punches, haers, pliers, adjustable wrenches, pipe wrenches, 3/8" and 1/2" drive sockets, ratchets and accessories
- Also includes is professional utility tools and scrapers

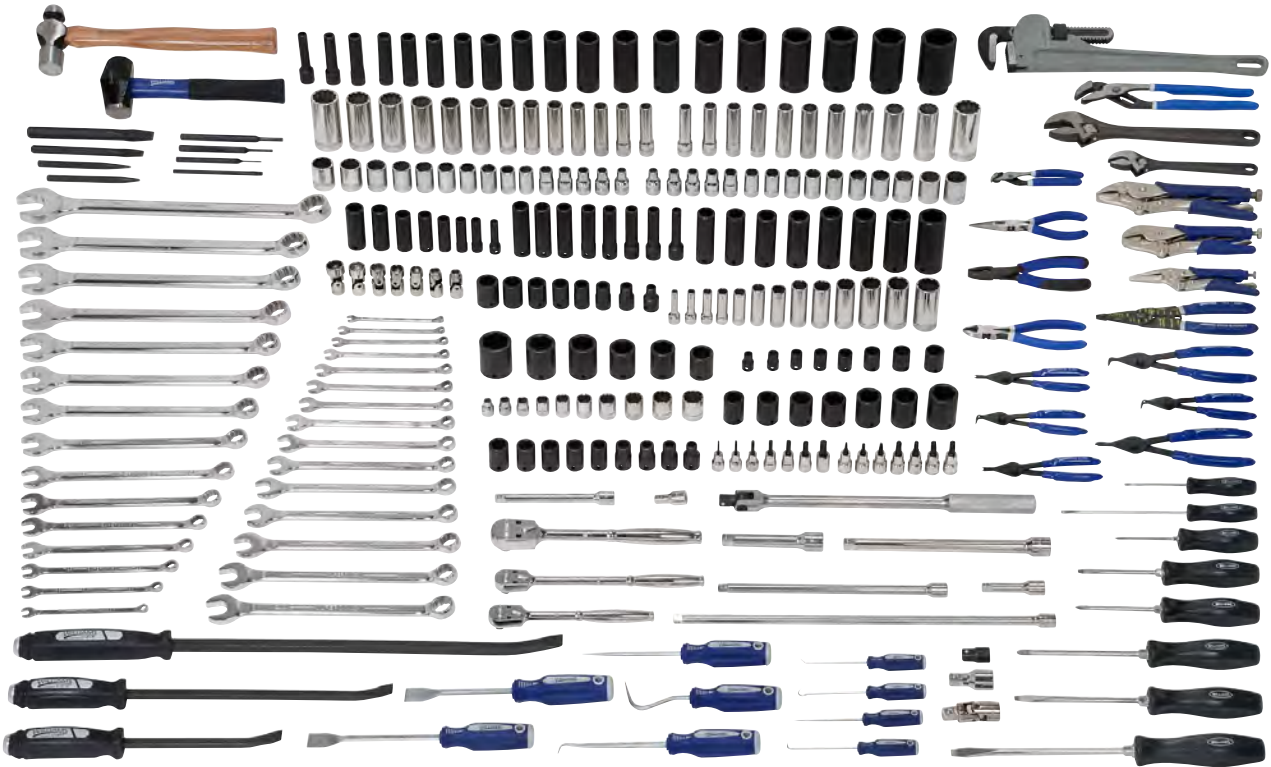

JHWPETROSET





JHWW40TC4

JHWW40RC7

OIL FIELD TOOL SET

Contains the following tools:

Product Category	Product Category
C-Clamp	Puller
Chain Wrench	Punch & Chisels
Hammer	Ratchets, Drive Tools and Accessories
Hex Key	Scraper
Miscellaneous	Screwdrivers
Nut Drivers	Snips
Pipe Wrench	Sockets
Pliers	Torque Wrench
Prybar	Wrenches

Set Configurations Available

Product Code	Description
JHWOILFIELD	Oil Field Tool Set Only
JHWOILFIELDTB	Complete Oil Field Tool Set with Tool Boxes

Tool Boxes Included

JHWW40TC4	40" Wide x 20" Deep 4 Drawer Top Chest
JHWW40RC7	40" Wide x 20" Deep 7 Drawer Tool Cabinet

Features

- The set provides the tools necessary for oilfield general service and repair applications
- Included are a wide variety of pliers, box wrenches, combination wrenches, flare wrenches, 1/4", 3/8" and 1/2" drive sockets, ratchets and accessories
- Also includes is c-clamps, chain wrench and other tools

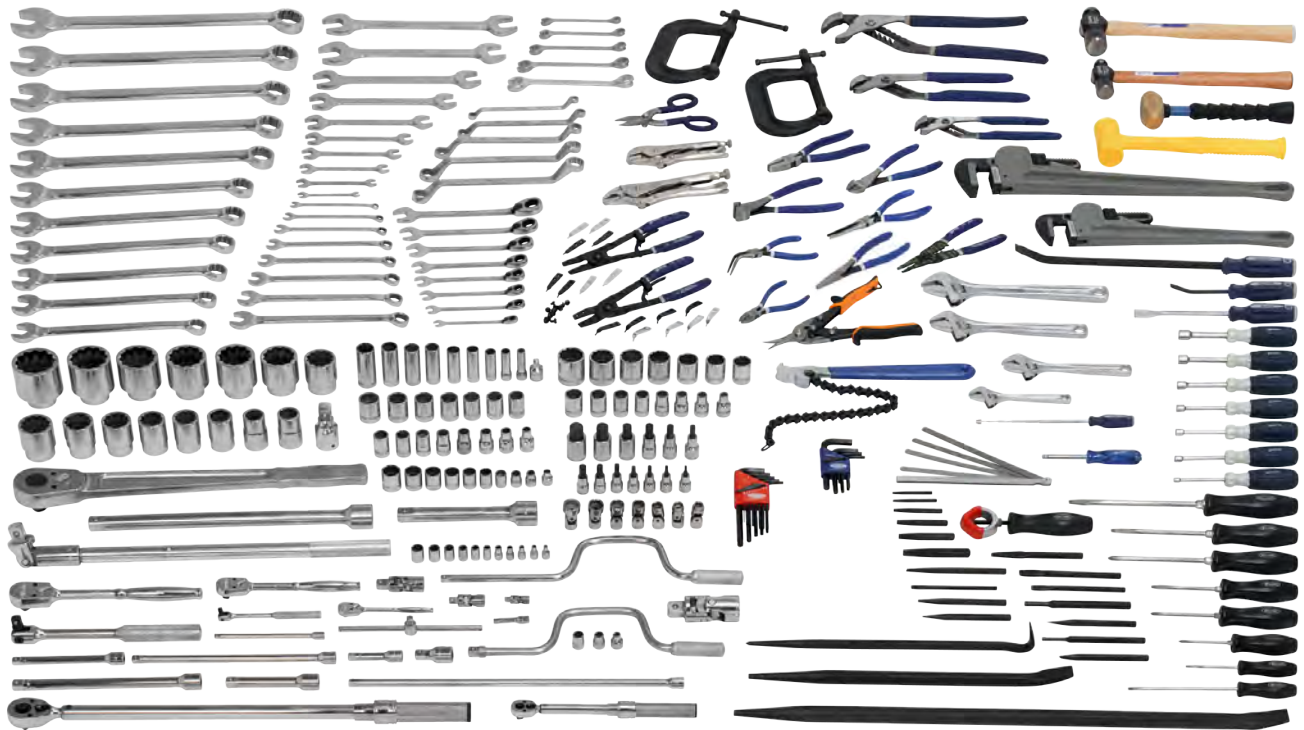

JHWOILFIELD



MECHANICAL MAINTENANCE SET

Contains the following tools:

Product Category	Product Category
Hammer	Ratchet, Drive Tools and Accessories
Hex Key	Screwdriver
Pliers	Sockets
Punch & Chisels	Wrenches

Set Configurations Available

Product Code	Description
JHWTMNT	Mechanical Maintenance Tool Set Only
JHWTMNTTB	Complete Mechanical Maintenance Tool Set with Tool Boxes

Tool Boxes Included

JHWW26TC4	26" Wide x 20" Deep 4 Drawer Top Chest
JHWW26RC7	26" Wide x 20" Deep 7 Drawer Tool Cabinet

Features

- The set provides the tools necessary for many general service and repair applications
- Included are a wide variety of pliers, box wrenches, hex keys, flare wrenches, 1/4", 3/8" and 1/2" drive sockets, ratchets and accessories
- Also includes is punch, chisels, hammers and other tools

JHWW26TC4



JHWW26RC7

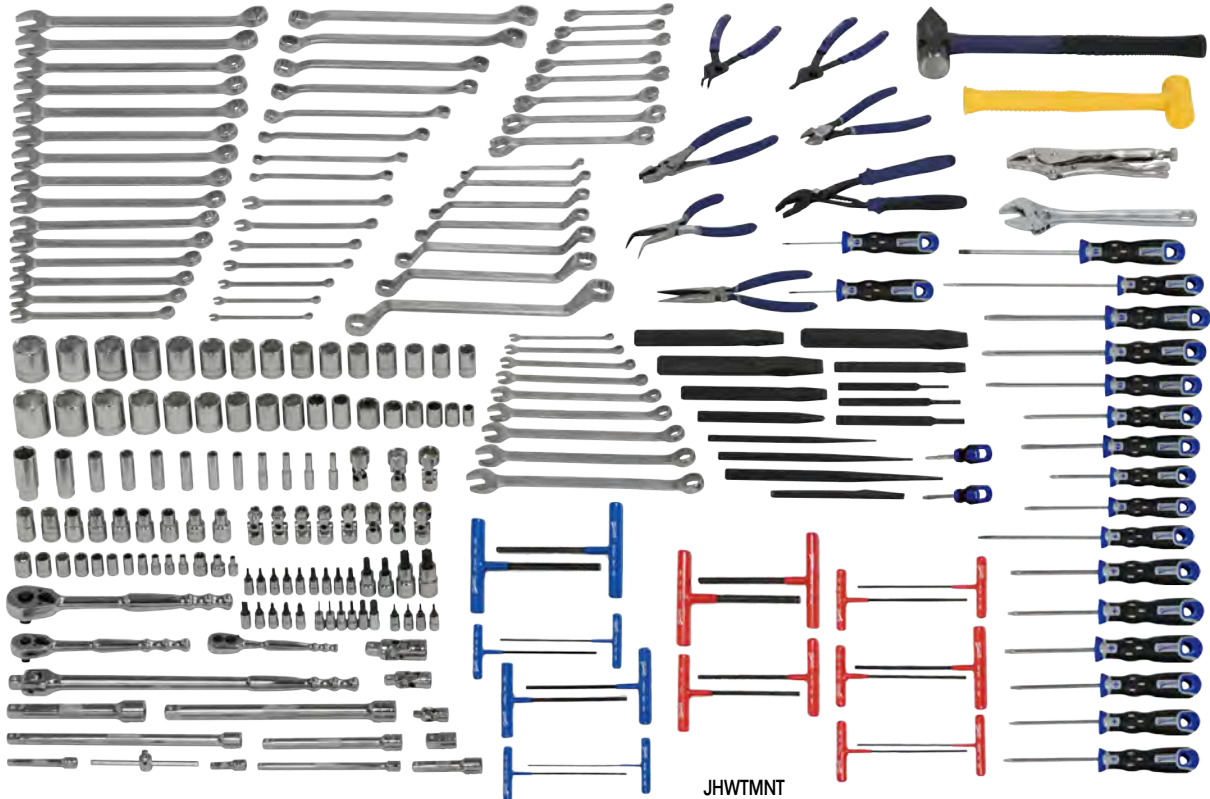

JHWTMNT



JHWW26TC4



JHWW26RC7

GENERAL MAINTENANCE TOOL SET

Contains the following tools:

Product Category	Product Category
C-Clamps	Ratchet, Drive Tools & Accessories
Chisels & Punches	Scrapers
Hammers	Screwdrivers & Bits
Files	Snips
Hacksaws	Sockets
Nutdrivers	Wrenches
Pliers	

Set Configurations Available

Product Code	Description
JHWGMNT	General Maintenance Tool Set Only
JHWGMNTTB	Complete General Maintenance Tool Set with Tool Boxes

Tool Boxes Included

JHWW26TC4	26" Wide x 20" Deep 4 Drawer Top Chest
JHWW26RC7	26" Wide x 20" Deep 7 Drawer Tool Cabinet

Features

- This set provides the tools necessary for most general service and repair applications
- Included are a wide variety of adjustable wrenches, locking pliers, screwdrivers, hammers and 1/4", 3/8" and 1/2" drive ratchets and accessories
- An assortment of professional industrial tools such as punches, chisels and pliers are also included



JHWGMNT



HEAVY DUTY MAINTENANCE SERVICE SET

Contains the following tools:

Product Category	Product Category
Chisel and Punches	Pliers
Clamps	Ratchets, Drive Tools, and Accessories
Feeler Gauge Set	Screwdrivers
Hammers	Tool Box
Hand Sockets	Wrenches

Set Configurations Available

Product Code	Description
JHWHDMNT	Heavy Duty Maintenance Tool Set Only
JHWHDMNTTB	Complete Heavy Duty Maintenance Tool Set with Tool Boxes

Tool Box Included

JHWW40RC7	40" Wide x 20" Deep 7-Drawer Roll Cabinet
-----------	---

Features

- Designed for the shop that performs maintenance on heavy equipment, this set emphasizes larger tools, including combination wrenches up to 2" and sockets up to 1-3/4"
- Ratchets, drive tools, and fractional sockets in 3/8", 1/2" and 3/4" drive are included, as well as a complement of screwdrivers, pliers, chisels, punches, hammers, and other common tools
- If you need a basic assortment of beefy tools, this is the set for you



JHWW40RC7

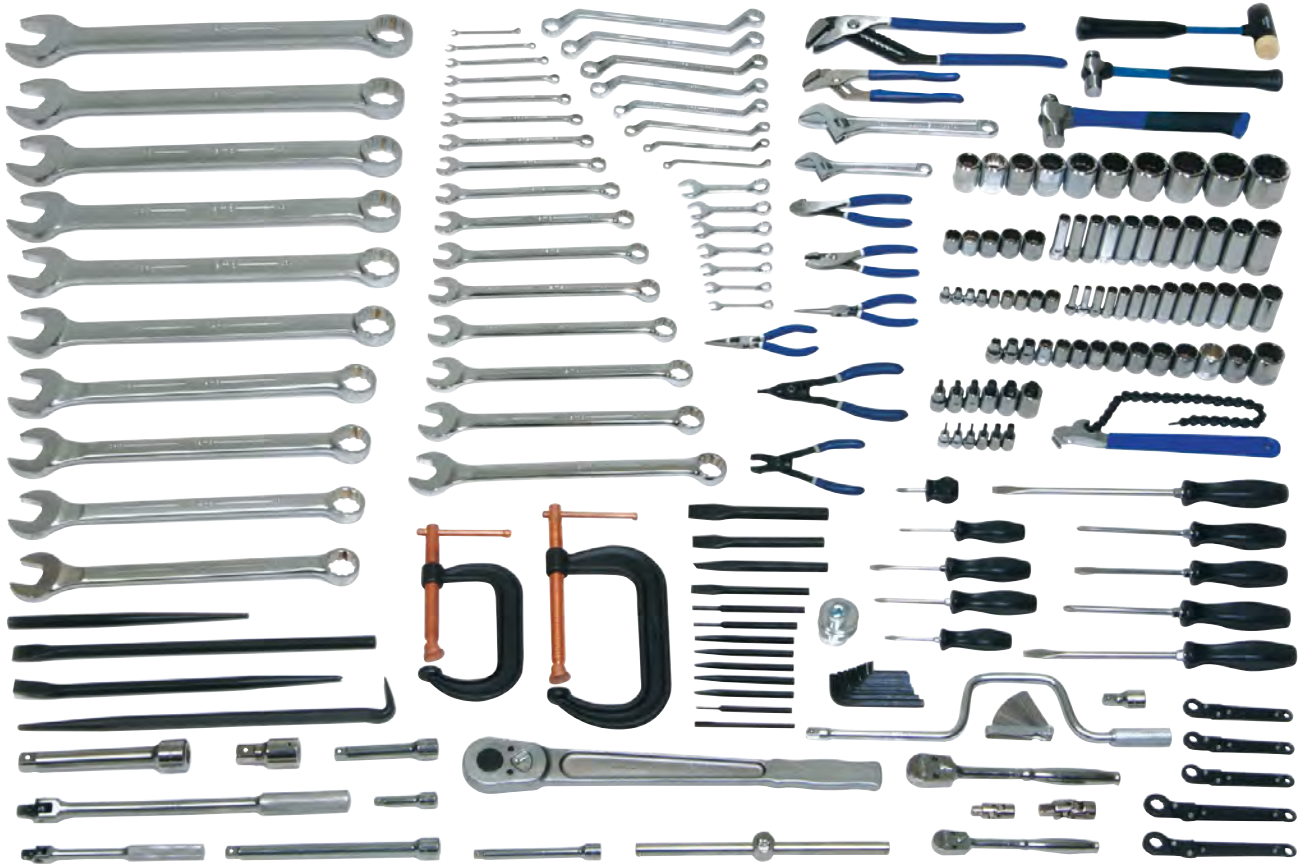

JHWHDMNT





JHWW40RC7

ELECTRICAL MAINTENANCE SERVICE SET

Contains the following tools:

Product Category	Product Category
Electrical Specialty Tools	Ratchets, Drive Tools, and Accessories
Hammers	Saws and Saw Blades
Hand Sockets	Screwdrivers
Miscellaneous Tools	Screwdrivers - Insulated
Pliers	Tool Box
Pliers - Electrical	Wrenches
Pliers - Insulated	

Set Configurations Available

Product Code	Description
JHWELECTRICAL	Electrical Maintenance Service Tool Set Only
JHWELECTRICALTB	Complete Electrical Maintenance Service Tool Set with Tool Boxes

Tool Box Included

JHWW40RC7	40" Wide x 20" Deep 7-Drawer Roll Cabinet
-----------	---

Features

- Designed to satisfy electrical maintenance tool requirements, this set has both the standard hand tools and special tools needed to accomplish a wide variety of electrical maintenance and installation
- 1/4" and 3/8" drive sockets and accessories, hammers, and hand wrenches, and add the special items needed for electrical work: insulated and non-insulated pliers and screwdrivers
- Full-size roll cabinet to organize, store, and move your tool set
- Unique in the industry, this set will help you get those critical electrical maintenance tasks done quickly, efficiently, professionally, and safely



JHWELECTRICAL



MAINTENANCE TOOL SET

Contains the following tools:

Product Category	Product Category
Chisels & Punches	Ratchet, Drive Tools & Accessories
Hammers	Screwdrivers & Bits
Hex Key Set	Sockets
Pliers	Wrenches

Set Configurations Available

Product Code	Description
JHWMNTCART	Maintenance Tool Tool Set Only
JHWMNTCARTTB	Complete Maintenance Tool Tool Set with Tool Cart

Tool Boxes Included

JHW50721	3 Drawer Service Cart with Lid
----------	--------------------------------

Features

- This set provides the tools necessary for most general service and repair applications. Included are a wide variety of adjustable wrenches, locking pliers, screwdrivers, hammers and 1/4", 3/8" and 1/2" drive ratchets and accessories. An assortment of professional industrial tools such as punches, chisels and pliers are also included.



JHW50721



JHWMNTCART



TOOL STORAGE

WILLIAMS
PROFESSIONAL

MODULAR INDUSTRIAL STORAGE	38
PROFESSIONAL SERIES	46
BULK STORAGE CAGES	50
SERVICE CARTS	50
JOBSITE BOXES	51
HAND CARRY BOXES	52
ROLL POUCHES	53
SOCKET RAILS & CLIPS	54



JOB SITE BOXES

Reinforced overlapping lid provides protection from weather and forced entry

Tread plate design for rugged durability

Recessed side handles for easy transportation

Heavy 16 gauge steel construction with 12 gauge feet

Heavy duty industrial gas struts make lid easy to open and close preventing accidental closure

Industrial powder coating for long lasting, non corrosive finish

Fully welded seams provide maximum strength

Recessed and concealed locking area protects padlock for ultimate security against drills and bolt cutter

PROFESSIONAL SERIES

Colors Available:

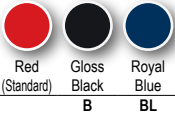

Heavy duty industrial gas struts make lid easy to open and close preventing accidental closure

Drawer liners included to keep tools in place

High-Quality Class I steel for enhanced strength and finish

Double wall construction provides strength

Reinforcement corner gussets add strength and reduce racking

2" mounting centers provide flexibility in arranging drawers to individual needs

All 4" and deeper drawers provide for adding additional slides to double drawer capacity

Two point locking design adds extra security on all chests

High luster paint protects against scratches, peeling, blistering and corrosion

Drawers equipped with positive latching drawer retention to prevent unwanted drawer opening

Rolled hem on all drawers provide superior strength, rigidity and safety

All drawers equipped with 75 pound full extension ball bearing slides with quick disconnect

TOOL STORAGE

CUSTOMIZE. ORGANIZE. OPTIMIZE.

MODULAR INDUSTRIAL STORAGE

Colors Available:

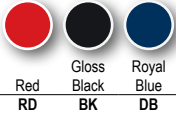

Hinged locking bar available for additional security



Lock in/Lock out latch available

Work surfaces available in a variety of shapes and materials



Fully MIG welded and surface ground on all eight corners, creating a cabinet that looks as good as it performs



Heavy duty 11ga plug-in guide rail allows for quick adjustment to accept different drawer sizes and combinations

Heavy duty 11ga carriage with six ball bearing rollers and four steel rollers ensures smooth operation of every drawer

Full-width aluminum handles with safety overlap and 45° angle
Overlap helps prevent injury by eliminating sharp edges and pinch points

100% View drawer extension provides full visibility and access to drawer contents via double roller tracks

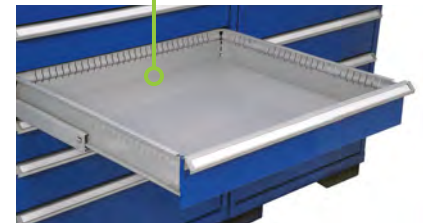

Full height drawer sidewalls provide maximum cubic storage capacity

Standard full length forklift base provides a safe platform for installing cabinets or for moving them when reconfiguring workspace



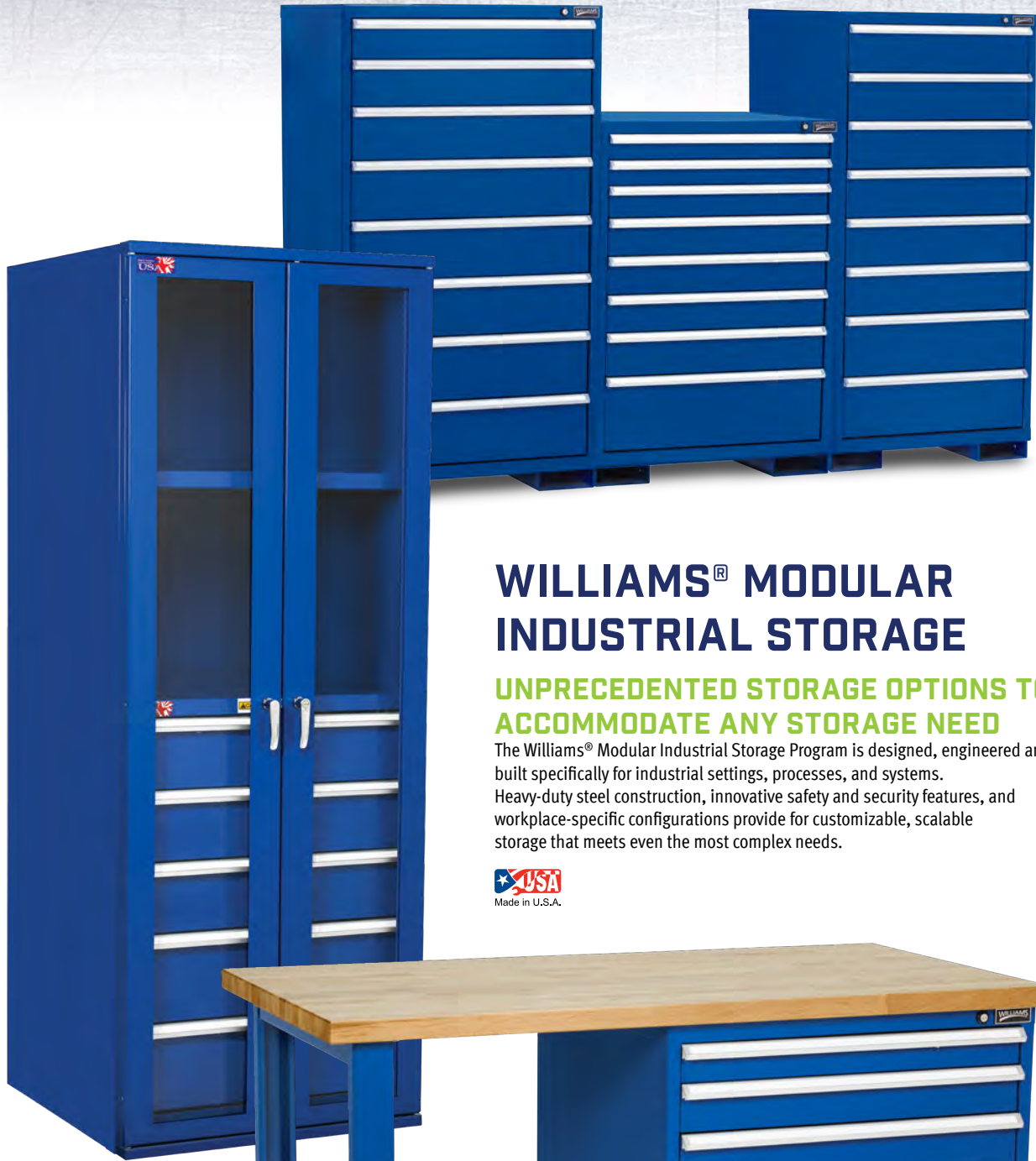

WILLIAMS® MODULAR INDUSTRIAL STORAGE

UNPRECEDENTED STORAGE OPTIONS TO ACCOMMODATE ANY STORAGE NEED

The Williams® Modular Industrial Storage Program is designed, engineered and built specifically for industrial settings, processes, and systems. Heavy-duty steel construction, innovative safety and security features, and workplace-specific configurations provide for customizable, scalable storage that meets even the most complex needs.



FOR MORE INFORMATION VISIT:
modularindustrialstorage.com





Cabinet Heights from 30" to 59"

Cabinet Widths from 23" to 58"

Standard full length forklift base

Multiple Drawer Height/Depth Options



Colors Available:

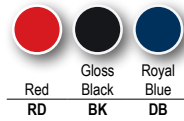

AVAILABLE SECURITY OPTIONS AND WORKSURFACES



LOCK IN/LOCK OUT LATCH
Locks individual drawers into position, either closed or fully extended. Recommended for truck and van storage applications.



HINGED LOCK BAR
Features padlock hasp for additional protection and security of drawers and contents.



WORK SURFACES
Available in a variety of shapes and materials.

ENGINEERED FOR INDUSTRIAL USE

SUPERIOR DESIGN AND CONSTRUCTION—INSIDE AND OUT

TOOL STORAGE

MODULAR INDUSTRIAL STORAGE



Fully MIG Welded and surface ground on all eight corners, creating a cabinet that looks as good as it performs.

Heavy duty 11ga plug-in guide rail allows for quick adjustment to accept different drawer sizes and combinations.

Heavy duty 11ga carriage with six ball bearing rollers and four steel rollers ensures smooth operation of every drawer, even when loaded to the 400 lb. capacity.

Full height sidewalls provide maximum cubic storage capacity, while reducing item spillover into adjacent compartments.

Full Width 45 degree angle aluminum handles for easy identification of contents.

Standard full length forklift base provides a safe platform for installing cabinets or for moving them when reconfiguring workspace. The removable kick panel combines enhanced safety with a clean look. (11ga fully welded optional pallet truck base available).

ESSENTIAL DRAWER FEATURES

17 Unique Drawer Sizes/Depths

Drawer heights in 20mm increments

Drawer	Drawer Model Point Value	Drawer Front Height (Inches)	Drawer Inside Usable Height (Inches)	Drawer Side Wall Height (Inches)
1	80	3	2 1/8	2
2	100	3 7/8	3	3
3	120	4 3/4	3 7/8	3 7/8
4	140	5 1/2	4 3/4	3 7/8
5	160	6 1/8	5 1/2	3 7/8
6	180	7	6 1/8	6
7	200	7 3/4	7	6
8	220	8 1/2	7 3/4	6
9	240	9 1/4	8 1/2	8 1/2
10	260	10 1/8	9 1/4	8 1/2
11	280	11	10 1/8	8 1/2
12	300	11 3/4	11	10 7/8
13	320	12 1/2	11 3/4	10 7/8
14	340	13 1/4	12 3/8	10 7/8
15	360	14 1/4	13 1/4	10 7/8
16	380	14 7/8	14	10 7/8
17	400	15 1/2	14 3/4	10 7/8

Taller drawers are available. Call your Williams Territory Manager for assistance. Drawer Capacity: 400-lbs UDL @ 100% extension



SAFE, STRONG & EFFICIENT DRAWER DESIGN

Riveted Drawer Fronts & Handles

Stainless steel rivets provide 650 lbs. of shear strength per rivet for outstanding durability. A minimum of 4 rivets are used to fasten the drawer front to the body and the drawer pull to the drawer front, creating a stronger bond than screws can.

Full-Width Aluminum Handles with Safety Overlap and 45° Angle
Overlap helps prevent injury by eliminating sharp edges and pinch points. The angled design allows improved handle label visibility.

SAFE OVERLAPPING HANDLE



SUPPORTS UP TO 400 LBS. PER DRAWER

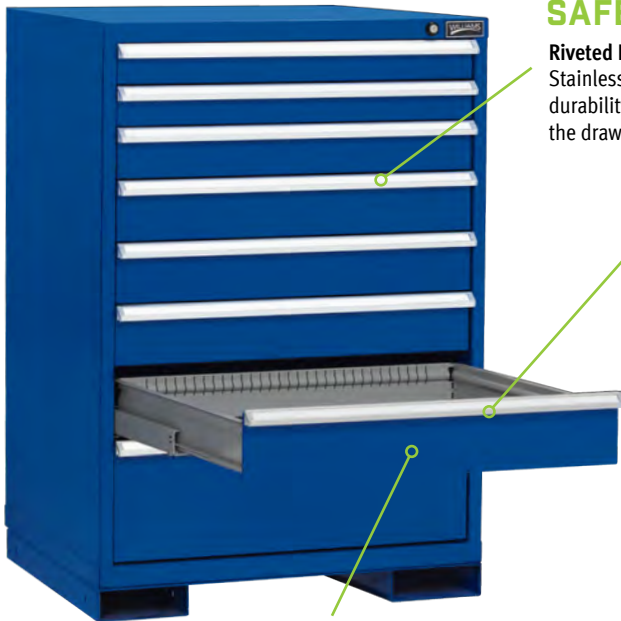

100% View Drawer Extension Full visibility and access to drawer contents via double roller tracks. Six high-quality steel ball bearings and four roller bearings support 400 pounds per drawer.

CABINET HEIGHTS & WIDTH OPTIONS

CHOOSE FROM SIX CABINET HEIGHTS

The Williams® Modular Industrial Storage Program features a large selection of cabinet housings to meet any demand. Choose from six heights to accommodate your company's personnel and space.

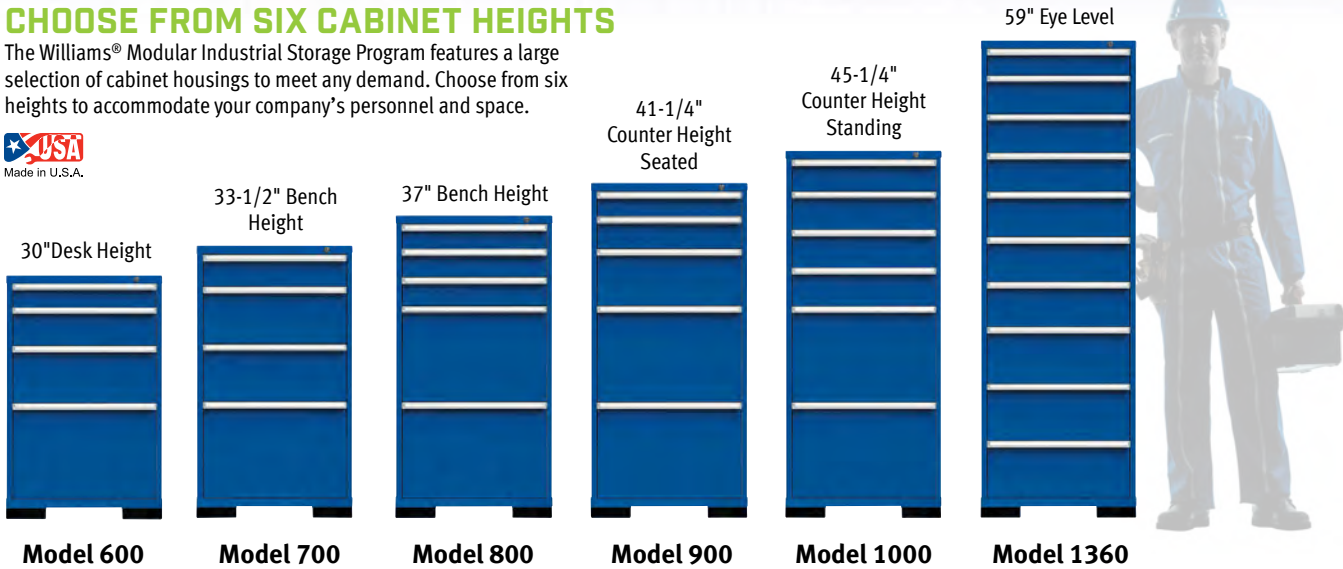

TOOL STORAGE

MODULAR INDUSTRIAL STORAGE

CHOOSE FROM FIVE CABINET WIDTHS

Cabinets are available in five different widths. Choose widths to accommodate your specific storage needs. All cabinets are 27-3/4" deep and are available in all cabinet heights.

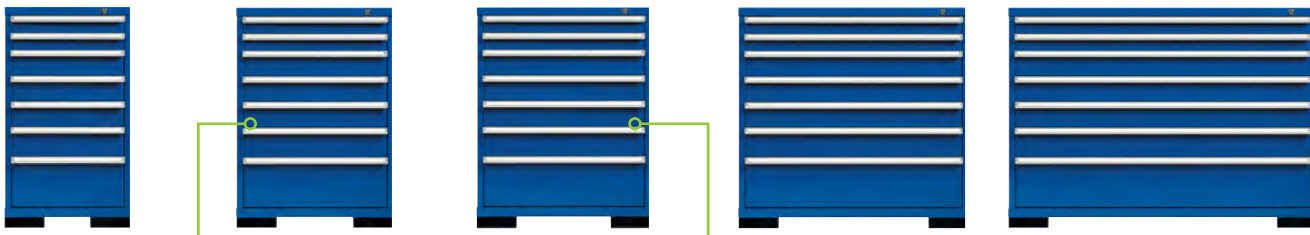

23" Narrow-Wide (NW)

- Makes excellent work station pedestals or mobile cabinets where space is limited
- Accommodates 18" items

29-1/4" Standard-Wide (SW)

- Recommended for most applications and provides the fastest pick-rates
- Accommodates items up to 24-1/2"

32-1/2" Standard-Wide Plus (SWP)

- Recommended for most applications and provides the fastest pick-rates
- Accommodates 28" items

46" Extra-Wide Plus (EWP)

- Recommended where parts or tools exceed 39"
- Accommodates 42" items

58-1/4" Double-Wide (DW)

- Recommended for extra-long items
- Accommodates items up to 53-1/2" wide



HUMAN-ENGINEERED DRAWERS – SQUARE DESIGN

The square **Standard Wide (SW)** drawer was ergonomically designed to accommodate the reach of the average person from either the front or the side, increasing picking productivity. Picking stock or retrieving parts from the side keeps aisles clear for increased efficiency and productivity.



MORE STORAGE SPACE

The innovative **Standard Wide Plus (SWP)** cabinet is an exclusive, providing up to 22% more storage than our SW (standard wide) cabinets or competitors' products.

DRAWER CONFIGURATIONS TO MEET EVERY NEED

CHOOSE FROM FIVE CABINET HEIGHTS

• Custom configurations are also available. Contact your Williams Territory Manager for details.



TOOL STORAGE

MODULAR INDUSTRIAL STORAGE

DESK HEIGHT - 30" TALL

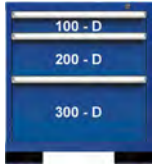

SW600F3DB

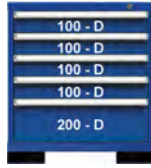

SW600F52DB

BENCH HEIGHT - 33" TALL

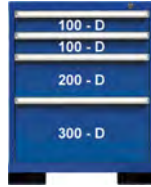

SW700F4DB



SW700F55DB

Colors Available:



COUNTER HEIGHT (SEATED) - 41" TALL



SW900F5DB



SW900F6DB



SW900F74DB



SW900F83DB



SW900F10DB

COUNTER HEIGHT (STANDING) - 45" TALL



SW1000F5DB



SW1000F6DB

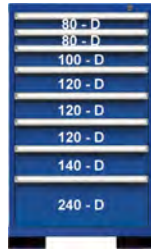

SW1000F8DB



SW1000F10DB



SW1000F11DB

EYE LEVEL HEIGHT - 59" TALL



SW1360F6DB



SW1360F72DB



SW1360F9DB



SW1360F10DB



SW1360F11DB



SW1360F14DB

CUSTOM DRAWER LAYOUTS FOR BETTER ORGANIZATION



TOOL STORAGE

MODULAR INDUSTRIAL STORAGE



Slotted Partitions in Drawer



SLC80-P



STEEL DIVIDERS

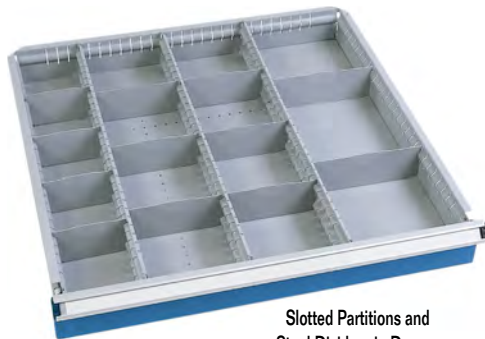

Slotted Partitions and Steel Dividers in Drawer

SLOTTED PARTITIONS

Product Code	Height (Inches)	For Use with Drawer Number
SLC80-P	2	80
SLC100-P	3	10
SLC120-P	3 7/8	120, 140, 160
SLC180-P	6	180, 200
SLC240-P	8 1/2	240
SLC300-P	10 7/8	300 and up

Features

- Powder-coated steel partitions subdivide drawers from front to back

Usable width of compartment (inches)	Number of units (spaces)
1 7/8	3U
2 5/8	4U
3 1/2	5U
4 1/4	6U
5 1/8	7U
7 3/8	10U
9 1/8	12U
12 1/4	16U

Features

- Powder-coated steel dividers further separate drawers when used with slotted partitions
- Dividers slide into slots of partitions or drawer sidewalls to form compartments

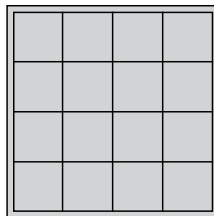

Layout No. 1

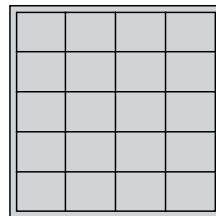

Layout No. 3

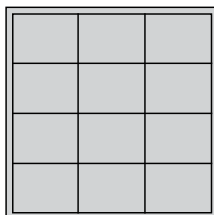

Layout No. 5

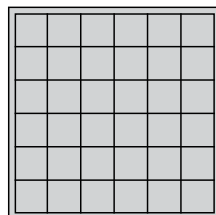

Layout No. 9

STANDARD WIDE (SW) DRAWER LAYOUTS

- Most popular drawer layouts shown
- Custom drawer layouts available

Layout No. 1

- 16 compartments
- 3 slotted partitions - 12 divider plates 8U

Layout No. 3

- 20 compartments
- 3 slotted partitions - 16 divider plates 8U

Layout No. 5

- 12 compartments
- 2 slotted partitions - 6 divider plates 10U
- 3 divider plates 12U

Layout No. 9

- 36 compartments
- 5 slotted partitions - 20 divider plates 5U
- 10 divider plates 6U

OPTIONS FOR EVEN GREATER SECURITY AND SAFETY



HINGED LOCK BAR

- Features a padlock hasp for additional protection and security of drawers and contents

LOCK IN/LOCK OUT LATCH

- Locks individual drawers into position, either closed or fully extended
- Recommended for truck and van storage applications

DRAWER ACCESSORIES MAXIMIZE STORAGE SPACE

TOOL STORAGE

MODULAR INDUSTRIAL STORAGE

MAXIMUM STORAGE IN MINIMUM SPACE!

Grooved Plastic Trays and Small Parts Containers

- Drawers are easily configured to perfectly match a wide variety of storage needs, from small parts such as fasteners and connectors, to delicate measuring equipment, cutting tools and electronic parts. Small parts containers and grooved plastic trays create custom layouts and drawer interiors to meet your specific needs.



GROOVED PLASTIC TRAYS

- Designed to protect side-sensitive tooling
- Available in 3 sizes

SLC50077

- Size 2 (2-7/8")

SLC50078

- Size 3 (1-7/8")

SLC50079

- Size 4 (1-3/8")



SLC50077



SLC50078



SLC50079



SLCA80A



SLCA80B



SLCN80



SLCN80-DIV



1-1/8

1-7/8

PLASTIC BINS

A Series

Product Code Size (Inches)

SLCA80A 2 1/2 x 2 1/2

SLCA80B 2 1/2 x 5

Features

- Modular design made of tough plastic with a usable height of 2"
- Two sizes available

PLASTIC BINS

N Series

Product Code Size (Inches)

SLCN80 6 x 6

SLCN80-DIV 6 x 6
(subdivided into four 3 x 3 compartments)

Features

- Modular design made of tough plastic with a usable height of 2"

LABEL HOLDERS

Product Code Size (Inches)

SLC50093 1 1/8

SLC50094 1 7/8

SLC50192 1 1/8

Features

- Transparent label holders clip onto plastic bins, grooved trays, and steel dividers
- Available in three sizes



MORE WAYS TO CUSTOMIZE, ORGANIZE, OPTIMIZE



Clear Vue doors (optional) made from plexiglass keep your equipment in sight and secure

18-gauge shelf notched to fit snugly around upright posts, preventing small items from falling through any gaps to the shelf below

Patented 11-gauge shelf support frames the system and supports heavy loads

Shelf reinforcement adds an additional 400 lbs. of load capacity

Powder-coat epoxy paint baked on to provide a high gloss finish

Colors Available:

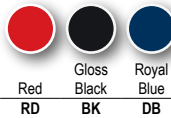

ORGANIZE BULKY ITEMS BY ADDING SHELVING

SHELVING UNITS

Organize bulky items by adding shelving storage to your cabinets. Their rugged, all-welded construction assures smooth operation, durability and years of dependable heavy-duty service. And because they're adjustable, you can rearrange the shelves to flexibly adapt to your storage needs for years to come.



Choose Options and accessories

Select between shelves and drawers, or a combination of the two, for the interior. You can also further customize the shelving unit with solid doors, Clear Vue doors, a fork lift base and extra shelves.

Choose from various sizes

Shelving units are available in different widths, depths and heights to meet your specific storage needs.

Widths: Narrow-Wide (NW) – 23-1/4"
Standard-Wide (SW) – 29-1/4"
Standard-Wide Plus (SWP) – 32-1/2"

Depths: Shallow-Depth (SD) – 23-1/2"
Standard-Depth (S) – 27-3/4"

Heights: 78" and 84"

GIVE YOUR WORKPLACE A PLACE TO WORK

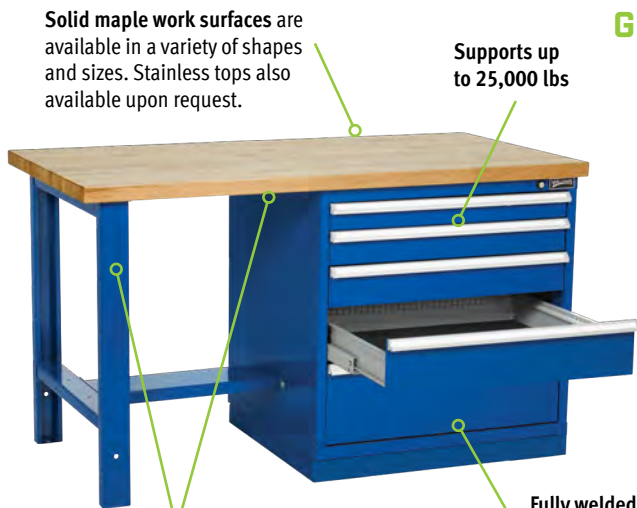

Solid maple work surfaces are available in a variety of shapes and sizes. Stainless tops also available upon request.

Supports up to 25,000 lbs

Customizable Height and Length workstations available in 5 heights and 7 lengths

Fully welded and crafted out of heavy gauge steel

Colors Available:

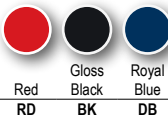

SLC50226

WORKSTATIONS

Every workplace needs a place to work. We deliver highly customizable workstations to fit your specific needs.

- Available as stationary or mobile
- Available with shelves, cabinets, or risers
- Can be topped with a variety of work surfaces and even add footrests
- Available in five heights
- Lengths available: 48", 60", 72", 84", 90", 120" and 144"
- Riser shelves are available in steel (painted or stainless) or maple
- Can be configured with various options such as an open leg or panel leg, casters, steel or maple work surfaces, risers, drawers, and more

WORKSTATION TOPS

Product Code	Description
NWMAPLETOP	NW Maple Top 30D X 24L
SWMAPLETOP	SW Maple Top 30D X 30L
SWPMAPLETOP	SWP Maple Top 30D X 33L
EWPMAPLETOP	EWP Maple Top 30D X 48L
DWMAPLETOP	DW Maple Top 30D X 60L
MAPLETOP3048	Maple Top 30D X 48L
MAPLETOP3060	Maple Top 30D X 60L
MAPLETOP3072	Maple Top 30D X 72L
MAPLETOP3090	Maple Top 30D X 90L

HANDLES & WHEELS

Product Code	Description
SLC50227	Caster Kit Set 4 and Handle Kit
SLC50226	Caster Kit Set 4

Features

- Make your storage mobile with our selection of handles and wheels
- Mobility workstations let you bring the work environment to the job, instead of going back and forth to and from the workstation

Features

- Powder-coated steel partitions subdivide drawers from front to back

55" PROFESSIONAL SERIES TOOL CABINETS

Designed for industrial use

Product Code	Description
JHWW55TC10	55" Wide x 24" Deep 10-Drawer Tool Chest
JHWW55RC11	55" Wide x 24" Deep 11-Drawer Roll Cabinet

Color Options: Standard color is red. To order in an optional color, simply add the appropriate color code to the end of the product code.
 Example: To order #JHWW55TC10 in Blue, specify product code JHWW55TC10BL

JHWW55TC10 Top Chest Overall Dimensions

Capacity (cu.in.)	Width (Inches)	Depth (Inches)	Height (Inches)
21283	55	24	28.5

Top Chest Drawer Sizes

Number	Width (inches)	Depth (inches)	Height (inches)
2	14 ⁵ / ₈	21 ⁵ / ₈	1 ³ / ₄
3	14 ⁵ / ₈	21 ⁵ / ₈	4
2	30 ¹ / ₂	21 ⁵ / ₈	1 ³ / ₄
3	30 ¹ / ₂	21 ⁵ / ₈	4

JHWW55RC11 Roll Cabinet Overall Dimensions

Capacity (cu.in.)	Width (Inches)	Depth (Inches)	Height (Inches)
25000	55	24	39

Roll Cabinet Drawer Sizes

Number	Width (inches)	Depth (inches)	Height (inches)
1	14 ⁵ / ₈	21 ⁷ / ₈	1 ³ / ₄
2	14 ⁵ / ₈	21 ⁷ / ₈	4
1	14 ⁵ / ₈	21 ⁷ / ₈	10 ⁹ / ₁₆
3	30 ⁹ / ₁₆	21 ⁷ / ₈	1 ³ / ₄
2	30 ⁹ / ₁₆	21 ⁷ / ₈	4
1	30 ⁹ / ₁₆	21 ⁷ / ₈	6 ³ / ₁₆
1	49	21 ⁷ / ₈	3 ³ / ₁₆

Features

- Made of High-Quality Class I steel to enhance strength and finish
- Double wall construction provides strength
- Reinforcement corner gussets add strength and reduce racking
- 2" mounting centers provide flexibility in arranging drawers to individual needs
- Drawers equipped with positive latching drawer retention to prevent unwanted drawer opening
- All drawers equipped with 75 pound full extension ball bearing slides with quick disconnect
- All 4" and deeper drawers provide for adding additional slides to double drawer capacity
- Rolled hem on all drawers provide superior strength, rigidity and safety
- Casters absorb vibrations transmitted to frame while moving on uneven surfaces
- Casters equipped with pedal brake and ball bearings for easy operation
- High luster paint protects against scratches, peeling, blistering and corrosion
- Paint pretreatment process both sprays and immerses boxes for added corrosion protection
- Drawer liners included at no extra charge
- Gas struts in lid of chest make lid easy to open and close
- Two point locking design adds extra security on all chests



JHWW55TC10



JHWW55RC11

Colors Available:

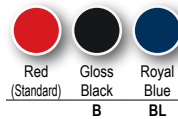

TOOL STORAGE

PROFESSIONAL SERIES





JHWW55RCBS

55" PROFESSIONAL SERIES ROLL CABINET

Designed for industrial use

Product Code	Description
JHWW55RC5BS	55" Wide x 24" Deep 5-Drawer Roll Cabinet with Bulk Storage

JHWW55RC5BS Roll Cabinet Overall Dimensions

Capacity (cu.in.)	Width (Inches)	Depth (Inches)	Height (Inches)
25,000	55	24	39

Roll Cabinet Drawer Sizes

Number	Width (inches)	Depth (inches)	Height (inches)
4	30 ⁹ / ₁₆	21 ⁷ / ₈	5
1	30 ⁹ / ₁₆	21 ⁷ / ₈	7
Bulk	23	21 ⁷ / ₈	33

Features

- Wide Drawer to hold long tools such as pry bars and extensions
- Bulk section with adjustable shelf perfect for storing large, bulky tools
- Made of High-Quality Class I steel to enhance strength and finish
- Double wall construction provides strength
- Reinforcement corner gussets add strength and reduce racking
- 2" mounting centers provide flexibility in arranging drawers to individual needs
- Drawers equipped with positive latching drawer retention to prevent unwanted drawer opening
- All drawers equipped with 75 pound full extension ball bearing slides with quick disconnect
- All 4" and deeper drawers provide for adding additional slides to double drawer capacity
- Rolled hem on all drawers provide superior strength, rigidity and safety
- Casters absorb vibrations transmitted to frame while moving on uneven surfaces
- Casters equipped with pedal brake and ball bearings for easy operation
- High luster paint protects against scratches, peeling, blistering and corrosion
- Paint pretreatment process both sprays and immerses boxes for added corrosion protected
- Drawer liners included at no extra charge
- Gas struts in lid of chest make lid easy to open and close
- Two point locking design adds extra security on all chests
- 8-05188ALRS – Replacement Slides

40" PROFESSIONAL SERIES TOOL CABINETS

Designed for industrial use

Product Code	Description
JHWW40TC4	40" Wide x 20" Deep 4-Drawer Top Chest
JHWW40RC7	40" Wide x 20" Deep 7-Drawer Roll Cabinet

Color Options: Standard color is red. To order in an optional color, simply add the appropriate color code to the end of the product code.
Example: To order #JHWW40TC4 in Blue, specify product code JHWW40TC4BL

JHWW40TC4 Top Chest Overall Dimensions

Capacity (cu. in.)	Width (inches)	Depth (inches)	Height (inches)
9746	40 1/2	19 13/16	19 7/16

Top Chest Drawer Sizes

Number	Width	Depth	Height
Top Compartment	39 29/32	18 23/32	4 23/32
2	34 11/16	17 17/32	1 13/32
2	34 11/16	17 17/32	3 19/32

JHWW40RC7 Roll Cabinet Overall Dimensions

Capacity (cu. in.)	Width (inches)	Depth (inches)	Height (inches)
15253	40	19 13/16	37 7/8

Roll Cabinet Drawer Sizes

Number	Width	Depth	Height
2	34 11/16	17 17/32	1 13/32
4	34 11/16	17 17/32	3 19/32
1	34 11/16	17 17/32	7 21/32

Features

- Made of High-Quality Class I steel to enhance strength and finish
- Double wall construction provides strength
- Reinforcement corner gussets add strength and reduce racking
- 2" mounting centers provide flexibility in arranging drawers to individual needs
- Drawers equipped with positive latching drawer retention to prevent unwanted drawer opening
- All drawers equipped with 75 pound full extension ball bearing slides with quick disconnect
- All 4" and deeper drawers provide for adding additional slides to double drawer capacity
- Rolled hem on all drawers provide superior strength, rigidity and safety
- Casters absorb vibrations transmitted to frame while moving on uneven surfaces
- Casters equipped with pedal brake and ball bearings for easy operation
- High luster paint protects against scratches, peeling, blistering and corrosion
- Paint pretreatment process both sprays and immerses boxes for added corrosion protection
- Drawer liners included at no extra charge
- Gas struts in lid of chest make lid easy to open and close
- Two point locking design adds extra security on all chests
- W40X50RV Side Handles
- Casters 5"x2", weight capacity 330 lbs. per caster
- Weight capacity 75 lbs. per rail



JHWW40TC4



JHWW40RC7

Colors Available:

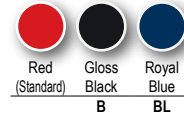



JHWW26TC4

JHWW26RC7

Colors Available:

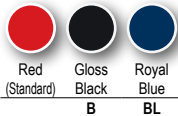

26" PROFESSIONAL SERIES TOOL CABINET

Designed for industrial use

Product Code	Description
JHWW26TC4	26" Wide x 20" Deep 4-Drawer Top Chest
JHWW26RC7	26" Wide x 20" Deep 7-Drawer Roll Cabinet

Color Options: Standard color is red. To order in an optional color, simply add the appropriate color code to the end of the product code. Example: To order #JHWW26TC4 in Blue, specify product code JHWW26TC4BL

JHWW26TC4 Top Chest Overall Dimensions

Capacity (cu. in.)	Width (inches)	Depth (inches)	Height (inches)
6180	26 ²³ / ₃₂	19 ¹³ / ₁₆	19 ¹³ / ₃₂

Top Chest Drawer Sizes

Number	Width (inches)	Depth (inches)	Height (inches)
Top Compartment	26 ¹⁹ / ₃₂	18 ²³ / ₃₂	4 ²³ / ₃₂
2	21 ³ / ₈	17 ¹⁷ / ₃₂	1 ¹³ / ₃₂
2	21 ³ / ₈	17 ¹⁷ / ₃₂	3 ¹⁹ / ₃₂

JHWW26RC7 Roll Cabinet Overall Dimensions

Capacity (cu. in.)	Width (inches)	Depth (inches)	Height (inches)
9374	26	19 ¹³ / ₁₆	37 ⁷ / ₈

Roll Cabinet Drawer Sizes

Number	Width (inches)	Depth (inches)	Height (inches)
2	21 ³ / ₈	17 ¹¹ / ₃₂	1 ¹⁵ / ₃₂
4	21 ³ / ₈	17 ¹¹ / ₃₂	3 ¹⁹ / ₃₂
1	21 ³ / ₈	17 ¹¹ / ₃₂	7 ²¹ / ₃₂

Features

- Made of High-Quality Class I steel to enhance strength and finish
- Double wall construction provides strength
- Reinforcement corner gussets add strength and reduce racking
- 2" mounting centers provide flexibility in arranging drawers to individual needs
- Drawers equipped with positive latching drawer retention to prevent unwanted drawer opening
- All drawers equipped with 75 pound full extension ball bearing slides with quick disconnect
- All 4" and deeper drawers provide for adding additional slides to double drawer capacity
- Rolled hem on all drawers provide superior strength, rigidity and safety
- Casters absorb vibrations transmitted to frame while moving on uneven surfaces
- Casters equipped with pedal brake and ball bearings for easy operation
- High luster paint protects against scratches, peeling, blistering and corrosion
- Paint pretreatment process both sprays and immerses boxes for added corrosion protection
- Drawer liners included at no extra charge
- Two point locking design adds extra security on all chests



BULK STORAGE CAGE

Secure storage with at-a-glance inventory control

Product Code	Description	Load Capacity (lbs)
JHWWBSC2460C	Mobile Bulk Storage Cage w/ Casters	900
JHWWBSC2460S	Stationary Bulk Storage Cage	1,800

Features

- Double door opening for easy access
- Door latch with padlock security loop
- Durable chrome finish
- Available with swivel and locking casters for easy mobility or stationary, without casters
- Dimensions: 62" wide x 68" high x 28.5" deep



JHWWBSC2460C

SERVICE CARTS

Easy and convenient access to tools when and where you need them.

Product Code	Description
JHW50721A	4 Drawers with Lid, Rack and Shelf, Blue
JHW50722A	2 Shelves, Blue
JHW50723A	2 Shelves with Locking Drawer, Blue
JHW50724	4 Drawers with Lid, Rack and Shelf, Red

Service Cart Overall Dimensions

Product Code	Width (inches)	Depth (inches)	Height (inches)
JHW50721A	35	17	41
JHW50722A	30	17	41
JHW50723A	30	17	36 7/8
JHW50724	35	17	41

Features

- High gloss powder coat paint is scratch & chemical resistant
- Storage drawers for frequently used tools
- Heavy duty undercarriage to help support bottom tray load
- 18 gauge heavy duty steel
- 4" x 1" swivel casters



JHW50721A



JHW50722A



JHW50723A



JHW50724

JOB SITE BOXES

Designed for the toughest outdoor work environments

Product Code	JHW50950B	JHW50951B	JHW50952B
Overall (Inches)			
Width	32	42	48
Depth	19	20	24
Height	17 1/2	23 1/2	27 1/2
Inside of body (Inches)			
Width	31	41 7/8	47 7/8
Depth	18 7/8	19 7/8	23 7/8
Height	11 1/8	17	21 1/8
Inside of top Lid (Inches)			
Width	31 7/8	41 7/8	47 7/8
Depth	18 7/8	19 7/8	23 7/8
Height	2 5/8	2 5/8	2 5/8
JHW50949	6" x 2" Swivel Caster Set		

Features

- Caster weight capacity is 3500 lbs, sold separately
- Tough industrial powder coating finish
- Heavy 16 gauge steel construction with 12 gauge feet
- Recessed and concealed locking area protects padlock for ultimate security against drills and bolt cutter
- Fully welded seams provide maximum strength
- Recessed side handles for easy transportation
- Reinforced overlapping lid provides protection from weather and forced entry
- Heavy duty industrial lid stays prevents accidental closure
- Tread plate design for rugged durability



JHW50950B
(Open)



JHW50950B
(Closed)

26" FLAT TOP TOOLBOX

Product Code	Width (Inches)	Depth (Inches)	Height (Inches)	Cubic Inch Capacity
JHWTB-6124B	26	8 3/4	9	1980

- Ruggedly constructed hand tool box
- Extra long tools up to 25" fit neatly inside
- Three compartment tray with socket divider to keep small tools better organized and close at hand
- Double drawbolts keep the lid tightly closed
- Padlock eye with slotted hasp provides security



JHWTB-6124B

21" FLAT TOP TOOLBOX

Product Code	Width (Inches)	Depth (Inches)	Height (Inches)	Cubic Inch Capacity
JHWTB-6123B	21	8 3/4	12	1606

- Ideal for general use
- Steel tote tray keeps smaller items handy
- Combination drawbolt and padlock eye provide security



JHWTB-6123B

19" FLAT TOP TOOLBOX

Product Code	Width (Inches)	Depth (Inches)	Height (Inches)	Cubic Inch Capacity
JHWTB-6119B	19	6	6 1/2	741

- Ideal for general use
- Steel tote tray keeps smaller items handy
- Combination drawbolt and padlock eye provide security



JHWTB-6119B

21" FOUR TRAY CANTILEVER TOOLBOX

Product Code	Width (Inches)	Depth (Inches)	Height (Inches)	Cubic Inch Capacity
JHWTB-6218B	21 1/4	8 3/4	12	1971

- Four trays cantilever outward when box is open providing access to the exceptionally deep box.
- Two of the trays feature movable dividers and another has a protective cover to prevent small tools or parts from spilling into the box.
- Formed feet in the box bottom add to strength and keep the box away from wet, dirty surfaces.



JHWTB-6218B



JHWTOTEBAGB

14" TOOL TOTE BAG

Product Code	Length (Inches)	Width (Inches)	Height (Inches)
JHWTOTEBAGB	14	11	10

Features

- Constructed from heavy Cordura® for maximum durability
- Ideal for storing and toting tools, parts, and supplies
- Heavy duty zippers for extra long life



JHWR-4A

ROLL POUCHES

Customize Your Own Tool Sets

Product Code	Number of Pockets	Width (Inches)	Height (Inches)
JHWR-1A	5	6	7 ½
JHWR-2A	5	8	12
JHWR-3A	5	11 ½	15 ½
JHWR-4A	5	12 ½	18 ½
JHWR-5A	5	16	25
JHWR-8A	15	17 ¼	10 ½
JHWR-10A	10	19 ¾	17 ¼
JHWR-11A	10	26 ½	25
JHWR-13A	10	34 ½	32
JHWR-20A	14	14 ½	8
JHWR-23A	8	23 ¼	26
JHWR-24A	4	8 ¾	11
JHWR-27A	17	23 ¼	17 ¾
JHWR-28A	26	19 ½	27
JHWR-29A	8	11	12 ¾
JHWR-30A	9	14 ¾	13
JHWR-31A	6	13 ¼	16
JHWR-36A	9	9 ¼	10 ½
JHWR-37A	15	37	26 ½
JHWR-41A	11	24	20
JHWR-42A	7	12 ¾	16
JHWR-48A	3	15 ¼	9 ¼
JHWR-49A	12	25 ¾	29

Features

- Heavy construction for long life
- Ideal for storing a variety of tools such as wrenches, extensions, and ratchets



JHW50001A



JHW50003A

VINYL POUCHES

Customize Your Own Tool Sets

Product Code	Width (Inches)	Height (Inches)
JHW50001A	4 ½	12 ½
JHW50003A	6	15
JHW50005A	7 ½	19
JHW50007A	9 ½	19
JHW097411A	6	¾
JHW099965A	9 ½	½

Features

- Extra heavy construction with snap fastening
- Clear plastic front panels allows full visibility to tools
- Metal grommets allow pouch to be hung on pegboard

METAL SOCKET SET TOOLBOXES

Rugged storage for Williams' premium socket sets

Product Code	Width (Inches)	Depth (Inches)	Height (Inches)	Gauge
JHWTB-101	10	7	1 ½	22
JHWTB-102	13	9	1 ¾	22
JHWTB-103	18	8	2	22
JHWTB-104	25	9	2	20
JHWTB-12	30 ¼	11 ½	4 ¾	18
JHWTB-35	14 ½	5 ½	1 ¾	22
JHWTB-49	24 ¾	8 ¾	3 ¾	18

Features

- Ruggedly constructed for long life
- Ideal for storing socket sets, other tools, and small parts
- Made from cold-rolled steel



Made in U.S.A.



JHWTB103

TOOL STORAGE

SOCKET STORAGE

PLASTIC SOCKET RAILS AND CLIPS

Product Code	Description	Material	Length (Inches)
JHWR-8BLUE	Socket Rail - Blue	Plastic	8
JHWR-8RED	Socket Rail - Red	Plastic	8
JHWR-13BLUE	Socket Rail - Blue	Plastic	13
JHWR-13RED	Socket Rail - Red	Plastic	13
JHWR-18BLUE	Socket Rail - Blue	Plastic	18
JHWR-18RED	Socket Rail - Red	Plastic	18

Product Code	Description	Package Quantity	Drive Size (Inches)
JHWRC-25-15P	Socket Clip	15 Pack	¼
JHWRC-37-15P	Socket Clip	15 Pack	¾
JHWRC-50-15P	Socket Clip	15 Pack	½

- Socket clips sold individually
- All rails hold any size clips



JHWRC-37-15P



JHWR-8BLUE

METAL SOCKET RAILS AND CLIPS

Product Code	Description	Material	Length (Inches)
JHWR-9	Socket Rail	Metal	9
JHWR-13R	Socket Rail	Metal	13
JHWR-17	Socket Rail	Metal	17

Product Code	Description	Material	Drive Size (Inches)
JHWRC-25	Socket Clip	Metal	¼
JHWRC-37	Socket Clip	Metal	¾
JHWRC-50	Socket Clip	Metal	½
JHWRC-75	Socket Clip	Metal	¾

- Socket clips sold individually
- All rails hold any size clips



Made in U.S.A.



JHWR-9

TORQUE TOOLS

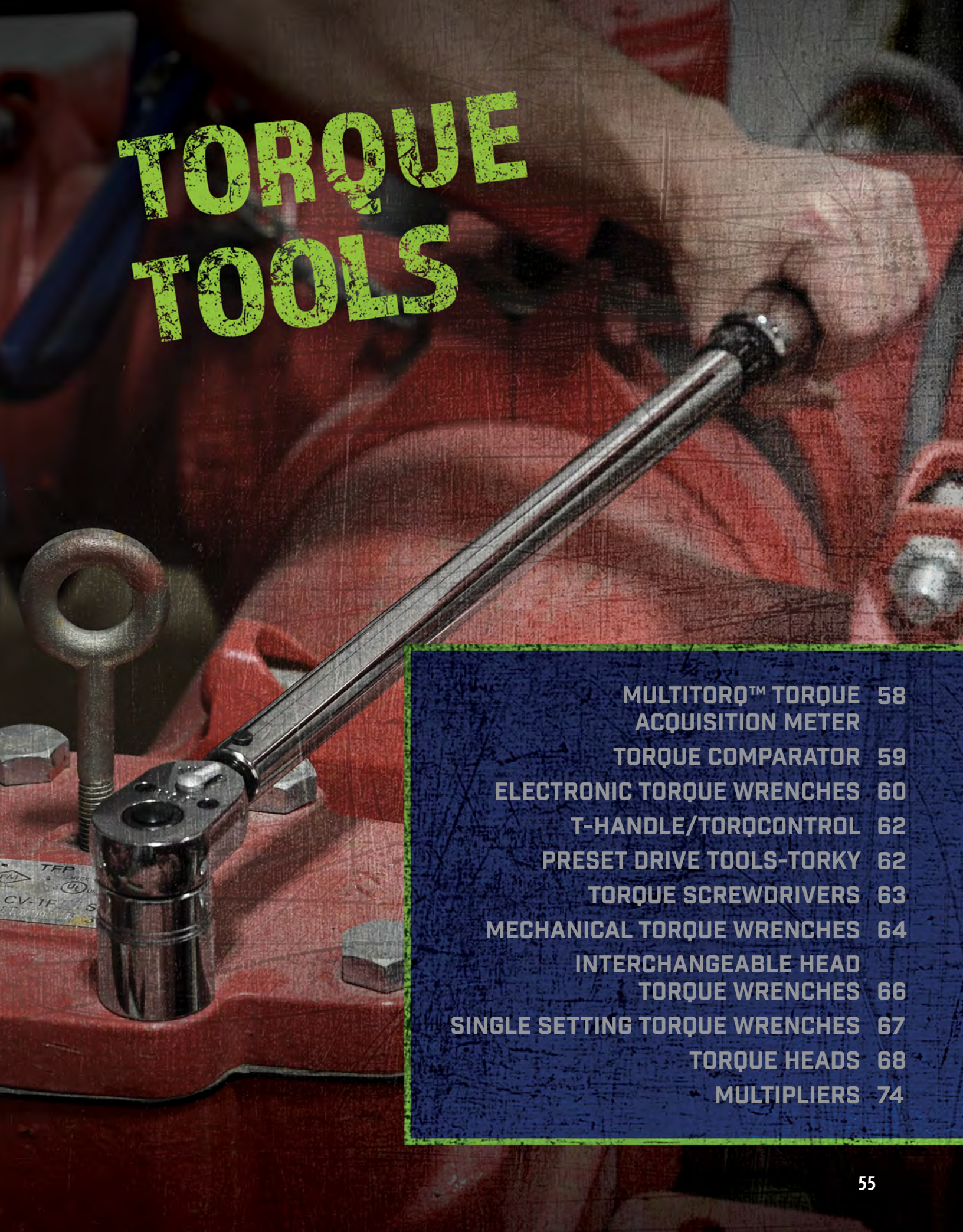

MULTITORQ™ TORQUE ACQUISITION METER	58
TORQUE COMPARATOR	59
ELECTRONIC TORQUE WRENCHES	60
T-HANDLE/TORQCONTROL	62
PRESET DRIVE TOOLS-TORKY	62
TORQUE SCREWDRIVERS	63
MECHANICAL TORQUE WRENCHES	64
INTERCHANGEABLE HEAD TORQUE WRENCHES	66
SINGLE SETTING TORQUE WRENCHES	67
TORQUE HEADS	68
MULTIPLIERS	74

TORQUE IN LESS TIME, WITH MORE ACCURACY AND CONTROL

ELECTRONIC TORQUE WRENCH

Sealed head keeps contamination out and lubrication in for better performance and longer tool life

Quick release 36 tooth gear ratchet head

Fully programmable - quickly change units of measure appropriate for specific applications

Low profile buttons protects against accidental activation

LED indicator lights
Dual-side LED lights with configurable settings provide operational guidance

Multi-sensory indicators
Easy-to-read LCD screen, LED indicator lights, audible beep and handle vibration work together to signal when torque is within the targeted range

Knurled positive grip handles

Strong & durable 100% steel body construction

MIRCROMETER ADJUSTABLE TORQUE WRENCHES

Sealed head keeps contamination out and lubrication in for better performance and longer tool life

36 Tooth precision reversible ratchet

Easy to read laser marked scales

Positive lock with spring loaded pull down lock ring

Knurled positive grip handles

Highly accurate: +/- 3 % of indicated value clockwise from 20 % to 100 % of full scale

TORQUE TOOLS

WORK MADE FASTER, EASIER AND SAFER

MULTITORQ™ TORQUE ACQUISITION METER

Sensors available in 1/4", 3/8", 1/2", 3/4" and 1" drive sizes



4 digit with alpha & numerical function flags

High and low torque limits are adjustable to give an audible and visual alarm

Data store/recall: 3500 measurements



Torque target settings are entered in keyboard

MICRO-ADJUSTABLE TORQUE SCREWDRIVERS



Cam-over torque limiting clutch for repeatability and accuracy

Automatic lock in counter-clockwise direction makes screw removal a snap

Permanently lubricated internal mechanism, never needs oil

Easy-to-read window scale and adjustment knob for precise settings

Industry standard 1/4" hex receiver allows use of all standard driver bits (Phillips, Torx, etc.)

Lightweight yet rugged construction, built to last

THE MICRO WITH MASSIVE VERSATILITY



Comfortable, slip resistant finish

Certified to the following industry specifications: ASME B107.300 - 2010 and ISO 6789

MULTITORQ™ TORQUE ACQUISITION METER

The **MULTITORQ™ torque acquisition meter** displays torque readings from sensors that attach between sockets and driver. MULTITORQ™ is a highly versatile torque analyzer/data acquisition system that can be used with sockets, extensions, universal joints, ratcheting drivers or any combination of these. Sensors are sold separately, available in 8 ranges from 2-20 in. ozs. to 150-1500 ft. lb. Accuracy ± 1% of reading (± 2% reading for 20 in. oz., and 10 in. lb.) 10-100% of sensor range.

The torque analyzer features a wide angle viewing LCD display with selectable readouts; ft. lb., in. lb., in. oz., Nm, dNm, mkg, and cmkg units. Torque target settings are entered via a push button membrane keyboard. High and low torque limits are adjustable to give an audible and visual alarm. The user selects Track mode to display torque values as they are applied, or Peak mode to display the highest torque value applied.

Features

- 4 digit w/ alpha & numerical function flags
- 4 digit, 8000 counts display capacity
- Accuracy: ± 1% of indicated value, cw & ccw, from 10% to 100% of full scale, 201-O-MT and 101-I-MT are ± 2%
- Soft touch keys: hi/lo alarm, zero tare, set-up, units, store/recall/clear, send, statistics, enter
- Units of measurement: ft. lb., in. lb., in. oz., Nm, dNm, mkg and cmkg
- Operating Temperature: 40 to 100 Degrees Fahrenheit (4 to 43 Degrees Celsius)
- Storage: -20 to 50 degrees C (-2 to 122 degrees F)
- Humidity: up to 90%, non-condensing
- Dimensions: 3" wide, 2.5" high (3" with belt clip), 6" deep
- Weight: 1 pound
- Charge life (full charge to shutdown): 100 hours continuous
- Data storage/recall: 3500 measurements
- Mini-USB: download port
- Three AA Alkaline Batteries (included)
- Reads bi-directionally (cw and ccw)

Standard Set Includes:

Product Code	Description
1600-MT2W	MULTITORQ™ Unit includes:
PB57A	Carrying Case
AW2-1/2D	Hex Key (Battery Install)
USBATOMINIB	Mini-USB Cable
276-61	Belt Clip

MULTITORQ™ TORQUE & DATA COLLECTION SENSORS

Sensors: (sold separately)

Product Code	Torque Range	Drive (In.)
201-O-MT2W	2 - 20 in. oz.	¼
101-I-MT2W	1 - 10 in. lb.	¼
501-I-MT2W	5 - 50 in. lb.	¼
2001-I-MT2W	20 - 200 in. lb.	¼
1002-F-MT2W	10 - 100 ft. lb.	¾
2503-F-MT2W	25 - 250 ft. lb.	½
6004-F-MT2W	60 - 600 ft. lb.	¾
15005-F-MT2W	150 - 1500 ft. lb.	1

Certificate of accuracy traceable to N.I.S.T. supplied with each transducer.
All components ordered separately.



Turns any ordinary ratchet wrench into a highly accurate digital torque tool.





TORQUE COMPARATOR

Large dual scale. Perfect when a quick check of your wrench is required before usage. Compact design allows for mounting on any flat surface in either horizontal or vertical position. Torque Comparator is calibrated on torque testers which are certified using test bars and "F" weights traceable to NIST. +/- 2% accuracy from 20% of full scale to full scale. Calibration Compliance Certificate.

Product Code	Square Drive	English Capacity	Inc.	Nm, Capacity	Inc.
1753-TC	1/2"	175 ft. lbs.	5 ft. lbs.	230 Nm	10 Nm
6004-TC	3/4"	600 ft. lbs.	5 ft. lbs.	800 Nm	20 Nm



TORQUE TOOLS

COMPARATOR

TORQUE SOLUTIONS

A FULL LINE OF PRODUCTS FOR EVERY INDUSTRY



The world's largest supplier of industrial quality torque tools and precision torque, force and tension calibration systems. Contact Williams® to learn more about our Calibration Systems, Digital Torque Testers and TorqueTools.



ELECTRONIC TORQUE WRENCH

TORQUE IN LESS TIME, WITH MORE ACCURACY AND CONTROL

Williams Electronic Torque Wrench are fully programmable for reliable, consistent, and repeatable torque applications. This electronic torque wrench is ideal for industrial working conditions and provides instant data on the exact torque actually applied.

Product Code	Square Drive	Torque Range (in.-lb.)	Torque Range (ft.-lb.)	Range (Nm)	Head Depth (Inches)	Head Width (Inches)	Weight (lbs)	Overall Length (inches)
2401EFRMH	1/4	12-240	1-20	1.36-27.12	1/2	7/8	0.93	11 5/8
12002EFRMH	3/8	60-1,200	5-100	7-135	3/4	1 1/8	1.60	15 3/8
1002EFRMH	3/8	60-1,200	5-100	6.8-135.0	3/4	1 1/8	2.85	19 1/8
2503EFRMH	1/2	150-3,000	12.5-250	16.9-339	7/8	1 5/8	4.35	26 3/4
6004ERMH	3/4	360-7,200	30-600	40.7-813.5	2 3/8	2 1/2	10.95	48 3/4

Features

- Features a 36 tooth gear quick release ratchet head that provides good socket retention as well as easy socket removal
- Sealed head keep contamination out and lubrication in for better performance and longer tool life.
- Handles are durable with are lightly knurled for a tough, non slip grip
- Dual Progressive LEDs allows user to view active torque readings and to anticipate torque target for more accurate torque
- Automatically compensates for flex related torque variances
- Easy to read Large LCD Screen, LED indicator lights, audible beep and handle vibrations work together to signal when torque is within the targeted range
- Rugged all steel body is designed to stand up to industrial use and each wrench is backed by a 1 year warranty
- Torque measured in seven modes: ft-lb, in-lb, Nm, dNm, kg-cm, angle and torque then angle
- Fully programmable with 10 memory presets
- Conveniently switches to angle mode without removing the torque wrench from a fastener in torque then angle mode
- Angle Accuracy: (+/- 1% of reading) + (+/- 1 DEG @ Angle Velocity >10 DEG/SEC < 180 DEG/SEC) + (+/- 1 DEG for test fixture)
- Torque accuracy: +/- 2% CW, +/- 3% CCW indicated value, 20% to 100 % of full scale
- Torque accuracy: +/-4% CW, +/-6 CCW indicated value, 10% to 19% of full scale
- Torque accuracy: +/- 8% CW, +/- 10% CCW indicated value, 5% to 9% of full scale

Fully programmable - quickly change units of measure appropriate for specific applications

Low profile buttons protects against accidental activation

Angle Head Control
Head flexes $\pm 15^\circ$ to avoid obstructions.

Sealed head keeps contamination out and lubrication in for better performance and longer tool life

Quick release 36 tooth gear ratchet head

Strong & durable
100% steel body construction

Multi-sensory indicators
Easy-to-read LCD screen, LED indicator lights, audible beep and handle vibration work together to signal when torque is within the targeted range



LED indicator lights
Dual-side LED lights with configurable settings provide operational guidance



TORQUE TOOLS

ELECTRONIC WRENCH

Blow-molded storage case

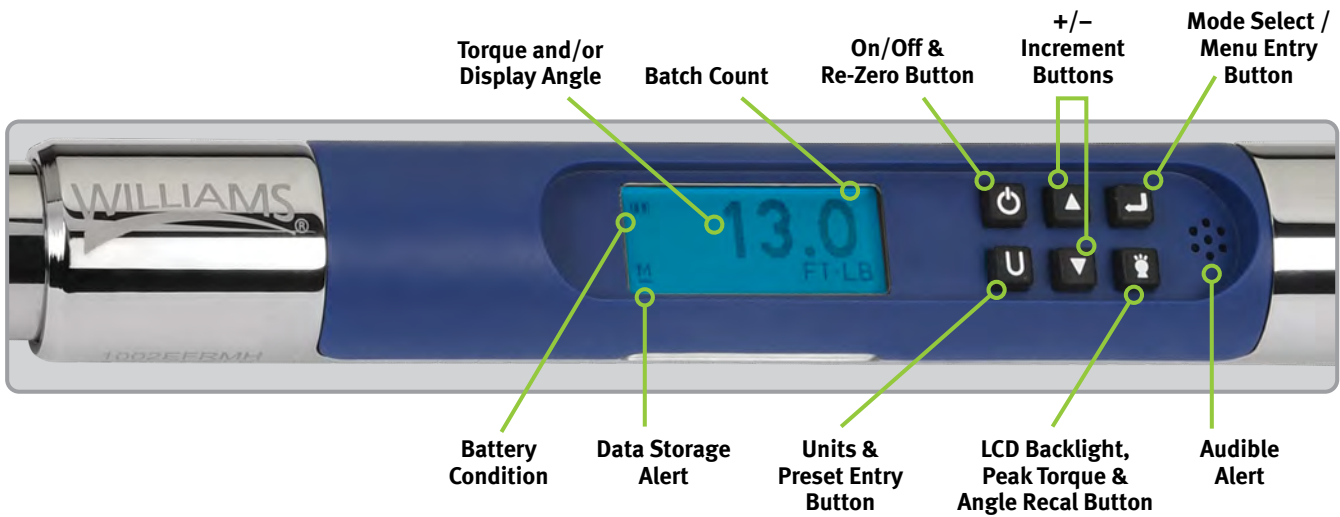

TORQUE LIMITING T-HANDLE - PRE-SET

Product Code	Nm	Pre Set Value		Bit
		Ft. Lb.	In. Lb.	
TLPT4NMW	4.0	2.9	35.4	4 mm
TLPT5NMW	5.0	3.7	44.3	4 mm
TLPT6NMW	6.0	4.4	53.1	4 mm

Features

- Torque Limiting Technology to Prevent Over-Tightening
- Magnetic Shank to Interchange Bits as Needed
- Rounded T-Handle Grip for Added Comfort
- Hi-Vis Color for Easy Identification
- Shaft accepts 1/4" hex shank bits, a 4 mm bit is included in each driver



TORQUE TOOLS

TORQCONTROL ADJUSTABLE TORQUE TOOL

ACCURATE, FAST, EASY AND ERROR-PROOF

Applying just the right amount of torque in low-torque applications can be tricky at times. The new patent-pending TorqControl Torque Tool is an adjustable, torque limiting tool that applies torque in a range between 2 Newton Meters (Nm) and 8 Nm, indexing at every tenth Newton Meter.

Product Code	Nm Range	Included Bits
TLA28NMW	2.0-8.0	4 mm, 5 mm, 6 mm, T25, 4" Long 4mm, 4" Long T25 Bits

Features

- Perfect for applying torque to bicycle components
- Magnetic tip holds, and allows for easy bit changes
- Standard 1/4" hex tip can utilize any standard hex bits
- Ergonomic L-shaped handle with rubberized cap for better grip
- Includes Certification of Accuracy
- TorqControl provides easy adjustability



T-HANDLE/TORQCONTROL/TORKY

PRESET DRIVE TOOLS - TORKY

TORKY is a right angle pre-set torque wrench. Torky is designed for production torque applications that require higher values than a torque screwdriver can deliver. The comfortable design eases the strain of repeated uses. Torque value may be ordered factory pre-set at an additional charge or it may be easily set by the operator with any quality torque calibration system. When the proper torque value is reached, a momentary release or "break" can be felt. Available in three drive styles to fit most needs.

Features

- Factory Pre-Set models are set at the factory to the customer's specified torque setting and are furnished with a Certificate of Calibration
- Please specify desired torque setting when order is placed
- Three models available
- Simple, easy to use design
- Ruggedly built for years of reliable service
- Operates bi-directionally
- Accuracy: $\pm 6\%$ of indicated value, CW, from 20% to 100% of full scale

Product Code	Product Code	Drive	Torque Range	W X L Length	Wt. Oz.
Un-Set	Factory Pre-Set				
1501TPA-1W	1501TPA-1-SETW	1/4" Female Hex	20-170 in.lbs.	1 x 5.25	8.3
1501TP-1W	1501TP-1-SETW	1/4" Male Square	20-170 in.lbs.	1 x 5.25	8.3
1502TP-1W	1502TP-1-SETW	3/8" Male Square	20-170 in.lbs.	1 x 5.25	8.3



Prevents premature wear of carbide inserts and damage to cutter head due to improper clamp load.





61SMW

Industry standard 1/4" hex receiver allows use of all standard driver bits (Phillips, Torx, etc.)

Certified to the following industry specifications: ASME B107.300 - 2010 and ISO 6789

Cam-over torque limiting clutch for repeatability and accuracy

Automatic lock in counter-clockwise direction makes screw removal a snap

Comfortable, slip resistant finish

Permanently lubricated internal mechanism, never needs oil

Easy-to-read window scale and adjustment knob for precise settings

Lightweight yet rugged construction, built to last

TORQUE SCREWDRIVERS - MICRO-ADJUSTABLE

Adjustable models offer versatility for applications that require more than one torque value. These torque screwdrivers are particularly suited for the electronics industry and for instrument assembly work. A simple, cam-over design prevents over-tightening and possible damage to components.

Torque settings are easily and accurately changed with a unique adjusting knob and easy-to-read window scale. Adjusting the screwdriver is simple. Just pull out the adjusting knob to unlock, turn to the desired setting, then push the knob in until it clicks!

Positive locking knob makes accidental setting changes impossible. Automatic lock in counterclockwise direction makes fastener removal a snap. The Micro-Adjustable series includes six models with torque settings ranging from 20 in. ozs. to 40 in. lbs.

Features

- 6 models available
- Positive locking pull down adjustment knob
- Trilobular comfort grip
- Universal 1/4" hex bit holder with strong rare earth magnet
- Cam-over torque limiting clutch
- Slip resistant finish
- Easy-to-read window scale
- Lightweight
- Automatic lock in CCW direction for removing screws
- Accuracy: $\pm 6\%$ of indicated value, CW, from 20% to 100% of full scale
- Individually serialized with matching certificate of calibration traceable to N.I.S.T.
- Meets or exceeds ASME B107.300 - 2010

Product Code	Torque Range	Increments	W x L Inches	Wt. Oz.
61SMW	20 - 100 in. ozs.	1 in. oz.	1.1 x 5.5	6.8
151SMW	3 - 15 in. lbs.	.2 in. lbs.	1.1 x 6.25	8.0
401SMW	5 - 40 in. lbs.	.5 in. lbs.	1.2 x 6.75	10.8
61NSMW	10 - 80 cNm	1 cNm	1.1 x 5.5	6.8
151NSMW	40 - 200 cNm	2 cNm	1.1 x 6.25	8.0
401NSMW	50 - 450 cNm	5 cNm	1.2 x 6.75	10.8



21SPW

TORQUE SCREWDRIVERS - SINGLE SETTING

The tamper resistant design of the **Single Setting** series is particularly suited for high-volume use in assembly operations. A simple, cam-over design prevents over-tightening and possible damage to components.

Torque screwdrivers may be ordered factory pre-set at an additional charge or they may be easily set by the operator with any quality torque calibration system. The end cap removes for easy access to the 1/8" hex adjustment screw. A hex adjustment key is included with each driver.

The Single Setting series includes four models with available torque settings from 6 in. ozs. up to 40 in. lbs. When precision and repeatability are a must, the choice is simple - Williams Torque Screwdrivers.

Features

- Factory Pre-Set models are set at the factory to the customer's specified torque setting and are furnished with a Certificate of Calibration
- Please specify desired torque setting when order is placed
- 4 models available
- Trilobular comfort grip
- Universal 1/4" hex bit holder with strong rare earth magnet
- Cam-over torque limiting clutch
- Rugged, light weight aluminum body
- Automatic lock in CCW direction
- Accuracy: $\pm 6\%$ of indicated value, CW, from 20% to 100% of full scale
- Meets or exceeds ASME B107.300 - 2010

Product Code Un-Set	Product Code Factory Pre-Set	Torque Range	W X L Length	Wt. Oz.
21SPW	21SP-SETW	6-32 in.ozs	1.1 x 4.5	5.3
61SPW	61SP-SETW	10 - 100 in.ozs.	1.1 x 5.6	7.0
151SPW	151SP-SETW	1.5 - 15 in. lbs	1.1 x 5.6	7.0
401SPW	401SP-SETW	4 - 40 in. lbs.	1.2 x 6.3	9.6



COMFORT GRIP MICROMETER ADJUSTABLE TORQUE WRENCHES - DUAL SCALE

Comfort-Grip Handle Dual Scale

Product Code	Drive Size (In.)	English Range	Incr.	Nm Range	Incr.	Overall Length (In.)	Head Width (In.)	Head Depth (In.)
1501MRPHW	1/4	20-150 in. lb.	1	2.8 - 15.3 Nm	0.12	9 3/4	7/8	4/8
2502MRPHW	3/8	30-250 in. lb.	1	4.0 - 27.7 Nm	0.12	11	7/8	5/8
10002MRPHW	3/8	150-1000 in. lb.	5	19.8 - 110.2 Nm	0.6	15 3/4	1 1/8	3/4
1002MFRPHW	3/8	10-100 ft. lb.	1	16.9 - 132.2 Nm	0.7	15 3/4	1 1/8	3/4
2503MFRPHW	1/2	30-250 ft. lb.	1	47 - 332 Nm	1.4	24 1/2	1 5/8	7/8
6004MFRPHW	3/4	100-600 ft. lb.	5	169 - 779 Nm	6.8	41 3/16	2 1/2	2 3/8

Features

- Dual scale, calibrated dual direction
- Positive lock with spring loaded pull down lock ring
- Fast, accurate and easy to set
- Easy-to-read laser marked scale
- 1/4", 3/8", 1/2" Drive feature quick release buttons which provide good socket retention as well as easy socket removal
- Ergonomic comfort-grip
- Accuracy: ± 3% CW of indicated value CW from 20% to 100% of full scale
- Meets or exceeds ASME standards, ISO 6789 standards
- Individually serialized with manufacturing certificate of calibration traceable to N.I.S.T.



TORQUE TOOLS

MECHANICAL WRENCHES



6004MFRPHW





MICROMETER ADJUSTABLE TORQUE WRENCHES - DUAL SCALE

Metal Handle Dual Scale

Product Code	Drive Size (In.)	English Range	Incr.	Nm Range	Incr.	Overall Length (In.)	Head Width (In.)	Head Depth (In.)
501MRMHW	1/4	10-50 in. lb.	0.50	1.4 - 5.4 Nm	0.50	9 5/8	7/8	1/2
1501MRMHW	1/4	20-150 in. lb.	0.50	2.8-15.3 Nm	0.120	9 3/4	7/8	1/2
1502MRMHW	3/8	20-150 in. lb.	1	2.8 - 15.3 Nm	0.12	9 3/4	7/8	5/8
2002MRMHW	3/8	30-200 in. lb.	1	4.0 - 22.0 Nm	0.12	10	7/8	5/8
2502MRMHW	3/8	30-200 in. lb.	1	4.0 - 27.7 Nm	0.12	10 7/8	7/8	5/8
7502MRMHW	3/8	100-750 in. lb.	5	14.1 - 81.9 Nm	0.60	15 5/16	7/8	5/8
10002MRMHW	3/8	150-1000 in. lb.	5	19.8 - 110.2 Nm	0.60	15 5/8	7/8	5/8
25003MRMHW	1/2	300-2500 in. lb.	10	39.6 - 276.9 Nm	1.2	19 3/16	1 5/8	7/8
752MFRMHW	3/8	5-75 ft. lb.	0.50	10.2 - 98.3 Nm	0.70	15 1/2	1 1/8	6/8
1002MFRMHW	3/8	10-100 ft. lb.	0.50	16.9 - 132.2 Nm	0.70	15 1/2	1 1/8	6/8
1503MFMHW	1/2	20-150 ft. lb.	1	34 - 197 Nm	1.4	18 3/4	1 5/8	7/8
1503MFRMHW	1/2	20-150 ft. lb.	1	34 - 194 Nm	1.4	18 3/4	1 5/8	7/8
2503MFRMHW	1/2	30-250 ft. lb.	1	47 - 332 Nm	1.4	24 5/16	1 5/8	7/8
4004MFRMHW	3/4	80-400 ft. lb.	5	85 - 491 Nm	3.4	34 3/16	2 1/2	2 3/8
6004MFRMHW	3/4	100-500 ft. lb.	5	169 - 779 Nm	6.8	41 1/8	2 1/2	2 3/8
10005MFRMHW*	1	200-1000 ft. lb.	5	305 - 1322 Nm	6.8	70 3/16	3 1/8	2 7/8

Features

- Knurled metal handle offers a tough, non-slip grip
 - Dual scale, calibrated dual direction
 - Positive lock with spring loaded pull down lock ring
 - Fast, accurate and easy to set
 - Easy-to-read laser marked scales
 - 1/4", 3/8", 1/2" Drive feature quick release buttons which provide good socket retention as well as easy socket removal
 - Accuracy: ± 3% CW of indicated value CW from 20% to 100% of full scale
 - Individually serialized with matching certificate of calibration traceable to N.I.S.T.
- *NOTE: 10005MFRMHW supplied with one extension handle and is packed in a metal box.



501MRMHW

INTERCHANGEABLE HEAD TORQUE WRENCHES

Features

- Interchangeable heads permit ratcheting, fixed, or open end torquing capability with adjustable torque wrench bodies.
- A push of the locking pin provides quick-change action, with a wide range of head styles to choose from.
- Micrometer Type Adjustment-ensures fast, accurate settings and changes.
- *Part Number 800NMIMH has Dual Pin Release for added strength
- Accuracy: $\pm 3\%$ of indicated value, in direction of torque indicator, from 20% to 100% of full scale

INTERCHANGEABLE HEAD TORQUE WRENCHES - DUAL SCALE

Product Code	Shank Size	Nm Range	Incr.	English Range	Overall Length (In.)
50NMIMHW	J	10 - 50	0.5	9.2 - 35	17
100NMIMHW	J	20 - 100	0.5	16.5 - 71.9	20
200NMIMHW	Y	40 - 200	2	37 - 140	22 ½
350NMIMHW	X	70 - 350	2	59 - 251	24 ½
800NMIMHW*	Z	150 - 800	5	129 - 572	48

INTERCHANGEABLE HEAD TORQUE WRENCHES - SINGLE SCALE

Product Code	Shank Size	English Range	Incr.	Overall Length (In.)	
75MFIMHSSW	J	5 - 75	0.5	16	Made in U.S.A.
150MFIMHSSW	Y	20 - 150	1	17	
250MFIMHSSW	Y	30 - 250	1	23	

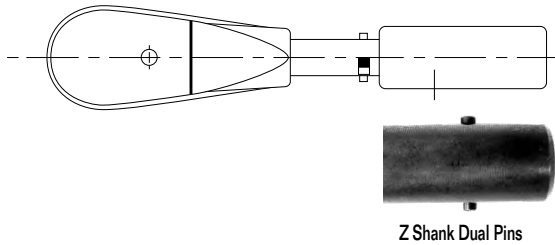

150MFIMHSSW



Interchangeable heads sold separately on pages 68-73.

SINGLE SETTING TORQUE WRENCHES

Product Code Un-Set	Product Code Factory Pre-Set	English Range	Nm Range	Shank Size	Overall Length (In.)	Head Width (In.)	Head Depth (In.)
5T-IW	5T-I-SETW	10-50 in. lb.	1.1 - 5.6	J	6 1/2	5/8	5/8
10T-IW	10T-I-SETW	50 - 250 in. lb.	5.6 - 28	J	10	5/8	5/8
10ST-IW	10ST-I-SETW	60 - 300 in. lb.	6.8 - 34	J	6	5/8	1
50T-IW	50T-I-SETW	15 - 75 ft. lb.	20 - 102	J	11	5/8	1
100T-IW	100T-I-SETW	30 - 150 ft. lb.	41 - 203	Y	19 1/2	1	1
200T-IW	200T-I-SETW	40 - 200 ft. lb.	54 - 271	Y	23 1/2	1	1
300T-IW	300T-I-SETW	100 - 300 ft. lb.	135 - 406	X	27 1/2	1	1
600T-IW	600T-I-SETW	120 - 600 ft. lb.	162 - 814	Z			

Features

- Designed for use on production lines and other applications where a specific torque is required for repetitive operations
- Factory Pre-Set models are set at the factory to the customer's specified torque setting, and are furnished with a Certificate of Calibration.
- Please specify desired torque setting when order is placed.
- Featuring a durable, non-slip cushion grip
- Uses universal round shank interchangeable heads
- Audible click and feel impulse torque control mechanism
- Tamper proof torque setting for production line use
- Accuracy: $\pm 3\%$ CW of indicated value, in direction of torque indicator, from 20% to 100% of full scale
- Meets or exceeds ASME B107.300-2010



Z Shank Dual Pins

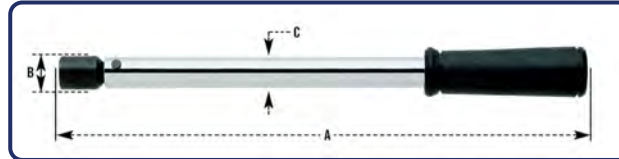

Z Shank
Dual Pins



RATCHETING SQUARE DRIVE HEADS - SAE

Square Drive (Inches)	J (0.425")	Max Torque Ft. Lbs.	Y (0.560")	Max Torque Ft. Lbs.	X (0.735")	Max Torque Ft. Lbs.	Z (0.990")	Max Torque Ft. Lbs.	Z Dual Pins	Max Torque Ft. Lbs.
1/4	QJD8A-72	60								
3/8	QJD12A-80	60	QYD12A-80	100						
1/2	QJD16A	60	QYD16A	240	QXD16A	240				
3/4					QXD24A	240	QZD24B	480	QZD24BDP	480
1					QXD32A	240	QZD32B	480	QZD32BDP	480



QJD16A

Z Shank
Dual Pins



FIXED SQUARE DRIVE HEADS - SAE

Square Drive (Inches)	J (0.425")	Max Torque Ft. Lbs.	Y (0.560")	Max Torque Ft. Lbs.	X (0.735")	Max Torque Ft. Lbs.	Z (0.990")	Max Torque Ft. Lbs.	Z Dual Pins	Max Torque Ft. Lbs.
1/4	QJSD8A	60								
3/8	QJSD12A	60	QYSD12A	100						
1/2	QJSD16A	60	QYSD16A	160	QXSD16A	240				
3/4					QXSD24A	240	QZSD24A	480	QZSD24ADP	480
1					QXSD32A	240	QZSD32A	480	QZSD32ADP	480



QJSD8A

Z Shank
Dual Pins



OPEN END HEADS - SAE

Square Drive (Inches)	J (0.425")	Max Torque Ft. Lbs.	Y (0.560")	Max Torque Ft. Lbs.	X (0.735")	Max Torque Ft. Lbs.	Z (0.990")	Max Torque Ft. Lbs.	Z Dual Pins	Max Torque Ft. Lbs.
1/4	QJO8A	5								
9/32	QJO9A	7								
5/16	QJO10A	9								
3/8	QJO12A	18								
7/16	QJO14A	26								
1/2	QJO16A	34								
9/16	QJO18A	58	QYO18A	58						
5/8	QJO20A	60	QYO20A	70						
11/16	QJO22A	60	QYO22A	99						
3/4	QJO24A	60	QYO24A	125	QXO24A	125				
13/16	QJO26A	60	QYO26A	160	QXO26A	164				
7/8	QJO28A	60	QYO28A	160	QXO28A	193				
15/16	QJO30A	60	QYO30A	160	QXO30A	200				
1	QJO32A	60	QYO32A	160	QXO32A	240	QZO32A	298	QZO32ADP	298
1 1/16	QJO34A	60	QYO34A	160	QXO34A	240	QZO34A	321	QZO34ADP	321
1 1/8	QJO36A	60	QYO36A	160	QXO36A	240	QZO36A	367	QZO36ADP	367
1 3/16	QJO38A	60	QYO38A	160	QXO38A	240	QZO38A	433	QZO38ADP	433
1 1/4	QJO40A	60	QYO40A	160	QXO40A	240	QZO40A	480	QZO40ADP	480
1 5/16			QYO42A	160	QXO42A	240	QZO42A	480	QZO42ADP	480
1 3/8	QJO44A	60	QYO44A	160	QXO44A	240	QZO44A	480	QZO44ADP	480
1 7/16			QYO46A	160	QXO46A	240	QZO46A	480	QZO46ADP	480
1 1/2	QJO48A	60	QYO48A	160	QXO48A	240	QZO48A	480	QZO48ADP	480
1 9/16			QYO50A	160	QXO50A	240	QZO50A	480	QZO50ADP	480
1 5/8	QJO52A	60	QYO52A	160	QXO52A	240	QZO52A	480	QZO52ADP	480
1 11/16					QXO54A	240	QZO54A	480	QZO54ADP	480
1 3/4			QYO56A	160	QXO56A	240	QZO56A	480	QZO56ADP	480
1 13/16					QXO58A	240	QZO58A	480	QZO58ADP	480
1 7/8			QYO60A	160	QXO60A	240	QZO60A	480	QZO60ADP	480
2					QXO64A	240	QZO64A	480	QZO64ADP	480
2 1/16					QXO66A	240	QZO66A	480	QZO66ADP	480
2 1/8					QXO68A	240	QZO68A	480	QZO68ADP	480
2 1/4			QY072	160			QZO72A	480	QZO72ADP	480
2 3/8									QZO76ADP	480
2 1/2			QY080	160			QZO80A	480	QZO80ADP	480
2 3/4							QZO88A	480		
3							QZO96A	480		



QJO16A



QZO36ADP

Center of fastener
to retaining pin:

QJ Series - 2.50"

QY Series - 3.00"

QX Series - 4.50"

QZ Series - 5.75"



Z Shank
Dual Pins



OPEN END HEADS - METRIC



Square Drive (mm)	J (0.425")	Max Torque Ft. Lbs.	Y (0.560")	Max Torque Ft. Lbs.	X (0.735")	Max Torque Ft. Lbs.	Z (0.990")	Max Torque Ft. Lbs.	Z Dual Pins	Max Torque Ft. Lbs.
6	QJOM6A	5								
7	QJOM7A	6								
8	QJOM8A	10								
9	QJOM9A	14								
10	QJOM10A	22								
11	QJOM11A	33								
12	QJOM12A	36								
13	QJOM13A	41								
14	QJOM14A	55	QYOM14A	55						
15	QJOM15A	60	QYOM15A	74						
16	QJOM16A	60	QYOM16A	88						
17	QJOM17A	60	QYOM17A	103	QXOM17A	103				
18	QJOM18A	60	QYOM18A	115	QXOM18A	115				
19	QJOM19A	60	QYOM19A	138	QXOM19A	138				
20	QJOM20A	60	QYOM20A	160	QXOM20A	160				
21	QJOM21A	60	QYOM21A	160	QXOM21A	180				
22	QJOM22A	60	QYOM22A	160	QXOM22A	206				
23	QJOM23A	60	QYOM23A	160	QXOM23A	229				
24	QJOM24A	60	QYOM24A	160	QXOM24A	240	QZOM24A	248	QZOM24ADP	250
25	QJOM25A	60	QYOM25A	160	QXOM25A	240			QZOM25ADP	275
26	QJOM26A	60	QYOM26A	160	QXOM26A	240			QZOM26ADP	298
27	QJOM27A	60	QYOM27A	160	QXOM27A	240	QZOM27A	319	QZOM27ADP	319
29			QYOM29A	160	QXOM29A	240			QZOM29ADP	379
30	QJOM30	60	QYOM30A	160	QXOM30A	240	QZOM30A	413	QZOM30ADP	413
32			QYOM32A	160	QXOM32A	240	QZOM32A	480	QZOM32ADP	480
34			QYOM34A	160	QXOM34A	240			QZOM34ADP	480
36	QJOM36A	60	QYOM36A	160	QXOM36A	240	QZOM36A	480	QZOM36ADP	480
37			QYOM37A	160						
38									QZOM38ADP	480
41			QYOM41	160	QXOM41A	240			QZOM41ADP	480
46					QZOM46A	240	QZOM46A	480	QZOM46ADP	480
50			QZOM50A	180			QZOM50A	480	QZOM50ADP	480
55					QZOM55A	240	QZOM55A	480	QZOM55ADP	480
60			QZOM60A	180	QZOM60A	240	QZOM60A	480	QZOM60ADP	480
65							QZOM65A	480	QZOM65ADP	480
70									QZOM70ADP	480

TORQUE TOOLS

HEADS



OPEN END THIN HEADS - SAE

Square Drive (Inches)	J (0.425")	Max Torque Ft. Lbs.	Y (0.560")	Max Torque Ft. Lbs.
9/16	QJO18ARTH	58		
7/8	QJO28ARTH	60		
11/16	QJO22ARTH60	60		
15/16	QJO30ARTH	60	QYO30ARTH	160
1	QJO32ARTH	60		
1 1/16	QJO34ARTH	60	QYO34ARTH	160
1 1/8	QJO36ARTH	60		
1 3/16	QJO38ARTH	60		
1 1/4	QJO40ARTH	60		
1 3/8	QJO44ARTH	60	QYO44ARTH	160
1 1/2	QJO48ARTH	60	QYO48ARTH	160
1 9/16	QJO50ARTH	60		
1 5/8	QJO52ARTH	60	QYO52ARTH	160
1 11/16	QJO54ARTH	60		
1 3/4	QJO56ARTH	60	QYO56ARTH	160
1 7/8	QJO60ARTH	60	QYO60ARTH	160
2	QJO64ARTH	60	QYO64ARTH	160
2 1/16	QJO66ARTH	60		
2 1/8	QJO68ARTH	60	QYO68ARTH	160
2 1/4			QYO72ARTH	160
2 11/16	QJO86ARTH	60		



QJO38ARTH

Z Shank
Dual Pins



12-POINT BOX END 15° OFFSET HEADS - SAE

Square Drive (Inches)	J (0.425°)	Max Torque Ft. Lbs.	Y (0.560°)	Max Torque Ft. Lbs.	X (0.735°)	Max Torque Ft. Lbs.	Z (0.990°)	Max Torque Ft. Lbs.	Z Dual Pins	Max Torque Ft. Lbs.
7/32	QJX7A	10								
1/4	QJX8A	18								
9/32	QJX9A	41								
5/16	QJX10A	41								
3/8	QJX12A	60								
7/16	QJX14A	60	QYX14A	60						
1/2	QJX16A	60	QYX16A	75						
9/16	QJX18A	60	QYX18A	112						
5/8	QJX20A	60	QYX20A	160	QXX20A	171				
11/16	QJX22A	60	QYX22A	160	QXX22A	200				
3/4	QJX24A	60	QYX24A	160	QXX24A	219				
13/16	QJX26A	60	QYX26A	160	QXX26A	240	QZX26A	275	QZX26ADP	275
7/8	QJX28A	60	QYX28A	160	QXX28A	240				
15/16	QJX30A	60	QYX30A	160	QXX30A	240	QZX30A	300	QZX36ADP	300
1	QJX32A	60	QYX32A	160	QXX32A	240				
1 1/16	QJX34A	60	QYX34A	160	QXX34A	240	QZX34A	480	QZX34ADP	300
1 1/8			QYX36A	160	QXX36A	240	QZX36A	480	QZX36ADP	480
1 3/16			QYX38A	160	QXX38A	240	QZX38A	480	QZX38ADP	480
1 1/4	QJX40A	60	QYX40A	160	QXX40A	240	QZX40A	480	QZX40ADP	480
1 5/16			QYX42A	160	QXX42A	240	QZX42A	480	QZX42ADP	480
1 3/8			QYX44A	160	QXX44A	240	QZX44A	480	QZX44ADP	480
1 7/16			QYX46A	160	QXX46A	240	QZX46A	480	QZX46ADP	480
1 1/2			QYX48A	160	QXX48A	240	QZX48A	480	QZX48ADP	480
1 9/16			QYX50A	160	QXX50A	240	QZX50A	480	QZX50ADP	480
1 5/8			QYX52A	160	QXX52A	240	QZX52A	480	QZX52ADP	480
1 11/16					QXX54A	240	QZX54A	480	QZX54ADP	480
1 3/4					QXX56A	240	QZX56A	480	QZX56ADP	480
1 13/16					QXX58A	240	QZX58A	480	QZX58ADP	480
1 7/8					QXX60A	240	QZX60A	480	QZX60ADP	480
2					QXX64A	240	QZX64A	480	QZX64ADP	480
2 1/16							QZX66A	480	QZX66ADP	480
2 1/8							QZX68A	480	QZX68ADP	480
2 3/16									QZX70ADP	480
2 1/4					QXX72A	240	QZX72A	480	QZX72ADP	480
2 3/8									QZX76ADP	480
2 1/2							QZX80A	480	QZX80ADP	480
2 9/16							QZX82A	480		



QJX12A

TORQUE TOOLS

HEADS



12-POINT BOX END 0° OFFSET - SAE

Square Drive (Inches)	J (0.425°)	Max Torque Ft. Lbs.	Y (0.560°)	Max Torque Ft. Lbs.
3/8	QJXD12A	60		
7/16	QJXD14A	60		
1/2	QJXD16A	60		
9/16	QJXD18A	60		
5/8			QYXD20A	160
11/16	QJXD22A	60	QYXD22A	160
3/4	QJXD24A	60	QYXD24A	160
7/8	QJXD28A	60	QYXD28A	160
15/16	QJXD30A	60	QYXD30A	160
1	QJXD32A	60		



QJXD24A



Z Shank
Dual Pins



12-POINT BOX END 15° OFFSET - METRIC



QJXM12A

Square Drive (mm)	J (0.425")	Max Torque Ft. Lbs.	Y (0.560")	Max Torque Ft. Lbs.	X (0.735")	Max Torque Ft. Lbs.	Z (0.990")	Max Torque Ft. Lbs.	Z Dual Pins	Max Torque Ft. Lbs.
6	QJXM6A	15								
7	QJXM7A	20								
8	QJXM8A	22								
9	QJXM9A	30								
10	QJXM10A	53								
11	QJXM11A	59								
12	QJXM12A	60								
13	QJXM13A	60	QYXM13A	75						
14	QJXM14A	60	QYXM14A	117						
15	QJXM15A	60	QYXM15A	148	QXXM14A	117				
16	QJXM16A	60	QYXM16A	160	QXXM16A	183				
17	QJXM17A	60	QYXM17A	160	QXXM17A	197				
18	QJXM18A	60	QYXM18A	160	QXXM18A	224				
19	QJXM19A	60	QYXM19A	160	QXXM19A	238			QZXM19ADP	238
20	QJXM20A	60	QYXM20A	160	QXXM20A	240				
21	QJXM21A	60	QYXM21A	160	QXXM21A	240				
22	QJXM22A	60	QYXM22A	160	QXXM22A	240				
23	QJXM23A	60	QYXM23A	160	QXXM23A	240				
24	QJXM24A	60	QYXM24A	160	QXXM24A	240	QZXM24A	375	QZXM24ADP	375
25	QJXM25A	60	QYXM25A	160	QXXM25A	240	QZXM25A	413	QZXM25ADP	413
26	QJXM26A	60	QYXM26A	160	QXXM26A	240	QZXM26A	448	QZXM26ADP	448
27	QJXM27A	60	QYXM27A	160	QXXM27A	240	QZXM27A	480	QZXM27ADP	448
29			QYXM29A	160	QXXM29A	240	QZXM29A	480	QZXM29ADP	480
30			QYXM30A	160	QXXM30A	240	QZXM30A	480	QZXM30ADP	480
32			QYXM32A	160	QXXM32A	240	QZXM32A	480	QZXM32ADP	480
34			QYXM34A	160	QXXM34A	240	QZXM34A	480	QZXM34ADP	480
36			QYXM36A	160	QXXM36A	240	QZXM36A	480	QZXM36ADP	480
41					QXXM41A	240			QZXM41ADP	480
46					QXXM46A	240			QZXM46ADP	480
50									QZXM50ADP	480
55									QZXM55ADP	480
60									QZXM60ADP	480

TORQUE TOOLS

HEADS



12 POINT RATCHET WRENCH HEADS - METRIC

Square Drive (mm)	J (0.425")	Max Torque Ft. Lbs.	Y (0.560")	Max Torque Ft. Lbs.
10	QJBOERM10A	60		
13	QJBOERM13A	60		
14	QJBOERM14A	60		
15	QJBOERM15A	60		
16	QJBOERM16A	60	QYBOERM16A	160
18	QJBOERM18A	60	QYBOERM18A	160
19	QJBOERM19A	60		
22	QJBOERM22A	60	QYBOERM22A	160
24	QJBOERM24A	60	QYBOERM24A	160



QJBOERM18

12 POINT RATCHET WRENCH HEADS - SAE

Square Drive (Inches)	J (0.425")	Max Torque Ft. Lbs.	Y (0.560")	Max Torque Ft. Lbs.
3/8	QJBOER12A	60	QYBOER12A	60
7/16	QJBOER14A	60		
1/2	QJBOER16A	60		
9/16	QJBOER18A	60	QYBOER18A	112
5/8	QJBOER20A	60	QYBOER20A	160
11/16			QYBOER22A	160
3/4	QJBOER24A	60	QYBOER24A	160
15/16			QJBOER30A	160



QJBOER14

12-POINT BOX END 10° OFFSET - SAE

Square Drive (Inches)	J (0.425")	Max Torque Ft. Lbs.	Y (0.560")	Max Torque Ft. Lbs.	X (0.735")	Max Torque Ft. Lbs.
1/2	QJXB16A	60				
9/16	QJXB18A	60				
5/8	QJXB20A	60	QYXB20A	79		
11/16	QJXB22A	60				
3/4	QJXB24A	60	QYXB24A	160		
7/8			QYXB28A	133		
15/16			QYXB30A	160		
1			QYXB32A	160		
1 1/8			QYXB36A	160		
1 3/8					QXXB44A	240
1 1/2					QXXB48A	240



QJXB18A

12-POINT BOX END 10° OFFSET - METRIC

Square Drive (mm)	J (0.425")	Max Torque Ft. Lbs.	Y (0.560")	Max Torque Ft. Lbs.
11mm	QJXBM11A	59		
12mm	QJXBM12A	60		
13mm	QJXBM13A	60		
14mm	QJXBM14A	60		
15mm	QJXBM15A	60		
16mm	QJXBM16A	60		
18mm	QJXBM18A	60	QYXBM18A	160
19mm	QJXBM19A	60		
24mm			QYXBM24A	160
28mm			QYXBM28A	160



QJXBM11A

12-POINT BOX END 40° BEND - METRIC

Square Drive (mm)	Y (0.560")	Max Torque Ft. Lbs.
16	QYSBM16A	60
18	QYSBM18A	160
24	QYSBM24A	160



QYSBM18A

12 POINT FLARE NUT HEADS - SAE

Square Drive (Inches)	J (0.425")	Max Torque Ft. Lbs.	Y (0.560")	Max Torque Ft. Lbs.
1/2	QJRX16A	60		
9/16	QJRX18A	60	QYRX18A	67
5/8	QJRX20A	60	QYRX20A	79
11/16	QJRX22A	60	QYRX22A	92
3/4	QJRX24A	60	QYRX24A	104
13/16	QJRX26A	60	QYRX26A	117
7/8	QJRX28A	60	QYRX28A	133
15/16	QJRX30A	60	QYRX30A	146
1	QJRX32A	60	QYRX32A	158
1 1/16	QJRX34A	60	QYRX34A	160
1 1/8	QJRX36A	60	QYRX36A	160
1 3/16			QYRX38A	160
1 1/4			QYRX40A	160
1 3/8			QYRX44A	160
1 7/16			QYRX46A	160
1 1/2			QYRX48A	160
1 9/16			QYRX50A	160
1 5/8			QYRX52A	160
1 7/8			QYRX60A	160
2			QYRX64A	160
2 1/4			QYRX72A	160



QJRX22A



6 POINT FLARE NUT HEADS - METRIC



QJRXSM11A

Square Drive (mm)	J (0.425")	Max Torque Ft. Lbs.	Y (0.560")	Max Torque Ft. Lbs.
8	QJRXSM8A	17		
9	QJRXSM9A	25		
10	QJRXSM10A	33		
11	QJRXSM11A	42		
12	QJRXSM12A	50		
13	QJRXSM13A	58	QYRXSM13A	58
14	QJRXSM14A	60		
15	QJRXSM15A	60	QYRXSM15A	71
16	QJRXSM16A	60	QYRXSM16A	75
17	QJRXSM17A	60	QYRXSM17A	83
18	QJRXSM18A	60	QYRXSM18A	94
19	QJRXSM19A	60	QYRXSM19A	104
20	QJRXSM20A	60	QYRXSM20A	113
21			QYRXSM21A	113
28			QYRXSM28A	120

6 POINT FLARE NUT HEADS - SAE



QJRXS8A

Square Drive (Inches)	J (0.425")	Max Torque Ft. Lbs.	Y (0.560")	Max Torque Ft. Lbs.
1/4	QJRXS8A	6		
5/16	QJRXS10A	17		
3/8	QJRXS12A	29		
7/16	QJRXS14A	42		
1/2	QJRXS16A	54		
9/16	QJRXS18A	60	QYRXS18A	74
5/8	QJRXS20A	60	QYRXS20A	74
11/16	QJRXS22A	60	QYRXS22A	92
3/4	QJRXS24A	60	QYRXS24A	104
13/16	QJRXS26A	60	QYRXS26A	117
7/8	QJRXS28A	60	QYRXS28A	133
15/16	QJRXS30A	60	QYRXS30A	146
1	QJRXS32A	60	QYRXS32A	158
1 1/8	QJRXS36A	60	QYRXS36A	160
1 1/4			QYRXS40A	160



RATCHETING FLARE NUT HEAD



RTWH40J

Square Drive (Inches)	Square Drive (mm)	J (0.425")	Y (0.560")	X (0.735")
3/8			RTWH24Y	
	11mm	RTWHM11J		
1/2		RTWH32J		
9/16		RTWH36J	RTWH36Y	
5/8		RTWH40J	RTWH40Y	
11/16		RTWH44J	RTWH44Y	
3/4		RTWH48J	RTWH48Y	
13/16		RTWH52J		
7/8		RTWH56J	RTWH56Y	
15/16		RTWH60J	RTWH60Y	
1		RTWH64J	RTWH64Y	
1 1/8			RTWH72Y	
1 1/4			RTWH80Y	RTWH80X
1 3/8			RTWH88Y	
1 1/2			RTWH96Y	RTWH96X
	16mm	RTWHM16J		
1 5/8			RTWH104Y	
1 3/16				RTWH116X
1 7/8			RTWH120Y	RTWH120X
2 1/8			RTWH136Y	
2 3/16			RTWH140Y	



QZD32A-1

QZ-X

ADAPTORS

Product Code	Descriptions
QJ-Y	J Male to Y Female
QXY	X Male to Y Female
QY-X	Y Male to X Female
QZ-X	Z Male to X Female
QZD32A-1	Z Shank 1 Drive Ratchets



TORQUE TOOLS HEADS

TORQUE MULTIPLIERS WITH HANDLES

Features

- Provides the operator with nut-turning power that requires only a fraction of the force required when using conventional tools.
- Input and output rotation is in the same direction.
- Reaction bar rotation is opposite to input direction and must rest securely against a rigid object to withstand the generated reaction force.
- By removing 4 screws, heads may be easily disassembled for inspection, cleaning and lubrication.

Product Code	Max Output Ft. Lbs.	Multiplication Ratio*	Approx. Ft. Lbs. Rq'd for Max Output	Input Female Sq.	Output Male Sq.	Head Thickness Inc. Tang	Head Diam.	Oal. Lgth. Inc. Reaction Bar
TM-750LW	1000	3.6 to 1	275	½	¾	3 ½	3 ½	22 ½
TM-1000	2000	3.6 to 1	550	¾	1	4 ¾	3 1 ½	24
TM-1500	4000	3.9 to 1	1150	1	1 ½	6 ⅛	5 ⅜	28 ⅞
TM-2000	8000	4.6 to 1	1915	1	1 ½	6 ¼	6 ½	31
TM-2500	12000	5.4 to 1	2200	1	2 ½	7 ¼	7 ¼	30

* Multipliers are mechanical devices which have frictional losses. A 10% factor was included in the multiplication ratio. For higher accuracy of multiplication ratio, output of unit should be checked on torque tester.

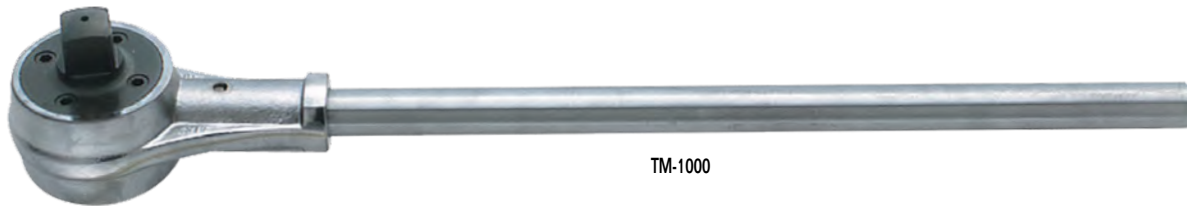

TORQUE TOOLS

MULTIPLIERS

TORQUE MULTIPLIERS WITH PLANETARY-GEAR MECHANISM

Features

- Designed where high torques are necessary for fastening or breaking out stubborn fasteners.
- Allows operator safe and easy means of producing torque for job requirements.
- Precision planetary gear multiplies the operator's input from standard torque wrenches.
- Can also multiply the torque from air-driven (non-impact) wrenches.

Product Code	Max Output Ft. Lbs.	Input Cap	Gear Ratio	Torque Ratio	Input Female Sq.	Output Sq. Size	Overall Length	Head Height Sq. to Top	Head Dia.
TM-290	750	227	4:1	3:1	½	¾	8 ½	3 ¼	2 1 ½
TM-391	1200	200	6:3:1	6:0:1	½	¾	19 39/64	4	3 1 ½
TM-392	2200	162	15:0:1	13:6:1	½	1	19 39/64	5 ¾	4 1 ½
TM-393	3200	173	20:25:1	18:5:1	½	1	19 39/64	6 ½	4 1 ½



PLATE REACTION TORQUE MULTIPLIERS

Features

- Input torque holding bracket - holds multiplier in place during torquing.
- Needle bearing construction for high efficiency.
- Standard reaction plate meets most job applications.
- Shearable output squares - to protect tool during overload.



Product Code	Max Output Ft. Lbs.	Input Cap	Gear Ratio	Torque Ratio	Input Female Sq.	Output Sq. Size	Overall Length	Head Height Sq. to Top	Head Dia.
TM-394	5000	189	29:25:1	26:5:1	½	1 ½	14 ²⁹ / ₃₂	8 ¾	5 ⅝
TM-395	8000	154	60:1	52:0:1	½	1 ½	15 ¹⁵ / ₆₄	10 ¼	5 ¹⁹ / ₁₆
TM-492	2200	162	15:1	13:6:1	½	1	14	5 ½	4 ⅞
TM-493	3200	173	20:25:1	18:5:1	½	1	14	6 ⅞	4 ⅞



TORQUE TOOLS

MULTIPLIERS



REPLACEMENT SQUARE DRIVES FOR TORQUE MULTIPLIERS

Replacement square drives for planetary-gear and plate reaction torque multipliers.

Product Code	Description
TM-391RSD	Repl. Sq Drive For TM-391
TM-392RSD	Repl. Sq Drive For TM-392 and TM-492
TM-393RSD	Repl. Sq Drive For TM-393 and TM-493
TM-394RSD	Repl. Sq Drive For TM-394
TM-395RSD	Repl. Sq Drive For TM-395



TORQUE PRODUCTS REPAIR AND CALIBRATION SERVICE

Trust the Williams Factory Service Center for all of your Williams torque product repair and calibration work. Use our convenient service website (www.williamsfactoryservice.com) to check services available, flat rate repair pricing, and to order and track your repair and calibration requests. The website enables you to order all regular paid repair and calibration services, as well as any warranty work needed.

The Williams torque tool factory and repair facility is located in City of Industry (Los Angeles), California. The factory has been ISO 9001 certified since 1998. The Williams Factory Service center repairs and calibrates with N.I.S.T. (National Institute of Standards and Technology) traceable calibration equipment, and Williams Torque Products meet or exceed ASME and ISO standards. Rely on the Williams Torque Products Factory Service Center to do the job right.

www.williamsfactoryservice.com

TORQUE 101

Need help educating your department or shop staff on why applying the correct torque is critical to proper assembly or maintenance operations?

The Williams **Torque Wrench 101** "textbook" is the perfect, simple and quick-read reference to train staff on what torque is. It explains why proper torque is important, torque wrench applications, proper torque wrench selection, and much more. Ask your Williams representative for your laminated copy today.

TORQUE 101

WHY PROPER TORQUE IS SO IMPORTANT!

It's about safety, reliability, and performance. EVERY manufacturer, whether it's in aerospace, motor vehicles, precision equipment, power generation, etc., specifies critical fastener torque for important reasons; under or over tightening critical fasteners can lead to product failure. And product failure means downtime, higher costs, potential injury, and more.

WHAT IS TORQUE?
Torque is rotational or turning force.

Torque is measured in length and force: Length means distance from "center of drive" to "center of handle". Force means "pounds", "Newtons" etc.

TORQUE
(Turning Force)

FORCE
(Pressure Applied)

LENGTH
(Distance from pivot point to force)

EXAMPLE:
Apply 80 ft. lbs. of torque, then apply 90 degrees of rotation

HOW DO YOU CALCULATE TORQUE?
Torque = Length x Force

The standard torque formula used to calculate torque is: "L x F = T"

EXAMPLE: 2 ft. (length) x 30 lbs. (amount of force at center of handle) equals 60 ft. lbs. of torque (60 Ft. Lbs.)

WHAT IS TORQUE PLUS ANGLE?
Torque Plus Angle creates a more exact clamp load for torque-sensitive equipment.

HEAD FRICTION
45% of Applied Torque

BOLT STRETCH
10% of Applied Torque

THREAD FRICTION
Up to 45% of Applied Torque

LOAD
Distributed over all threads

WHAT DOES TORQUE DO?
Torque creates a "Clamp Load" to join two pieces of material.

- Bolts (or threaded fasteners), are designed to create clamping force, also called "clamp load".
- When torque is applied to a threaded fastener, it draws together the joint, (two pieces of material).
- As additional torque is applied to the fastener, the joint is pulled together creating a clamp load as the fastener begins the stretching process. It's this fastener stretch that creates and maintains clamping force, like a stretched bungee cord maintaining tension.
- The actual amount of clamp load is determined by several factors:
 - The amount of torque applied to the fastener.
 - The material and grade of the fastener.
 - The external friction on the joint - friction under the fastener head, and friction between the threads of the fastener and material it's connected to.

WHY IS APPLYING PROPER TORQUE IMPORTANT?
Creating proper Clamp Load prevents damage and equipment failures.

- Safety & Performance: Applying accurate torque is critical to assembly applications, engines and precision equipment.
- Creating a proper clamp load is the main objective when applying torque to a fastener. Engine cylinder heads, pipe coupling, wheels, all need to be "clamped" uniformly to specific torque values.
- There are three main factors that affect the correct application of torque: (1) Condition of components, (2) Accuracy of torque instrument, (3) Properly applied torque values.
- Applying torque incorrectly can lead to stripped threads, premature loosening or broken fasteners that can cause catastrophic failure. Leaking joints may cause engine or equipment failures.

TOOLS@HEIGHT™



MASTER SETS	80
LANYARDS	91
TOOL HOLSTERS	94
WRENCHES	98
TORQUE WRENCHES	108
SOCKETS & DRIVE TOOLS	109
SCREWDRIVERS	120
PLIERS	122
HAMMERS	127
PUNCHES & CHISELS	129
HACKSAWS / SCRAPERS	133
MISCELLANEOUS TOOLS	135



YOU DON'T HAVE TO CHOOSE BETWEEN SAFETY OR PRODUCTIVITY. YOU CAN HAVE BOTH!

Safety and productivity are critical to your company's efficiency and profitability and the loss of productivity can occur for a variety of reasons. That's why we designed the Tools@Height™ system to provide effective, reliable drop prevention that keeps your workers safe...and working.



Save time and money -
Engineered attachment points don't interfere with the functionality of the tools.

Leave it to the experts -
We will work with you to determine your drop prevention needs and provide a complete system to help your workers work safely and efficiently.

Retain control -
Our modular approach allows you to configure tools and holsters to your needs.

Beat the statistics -
Approximately 70% of drops happen during the exchange of the lanyard from one tool to another. The Tools@Height System tethers each tool with its own lanyard, minimizing exchanges and reducing the likelihood of drops.

Minimize risk -
Independent tethering allows a tool to be removed and returned to its holster with one hand so the user can maintain the critical "three points of contact" when working at height.

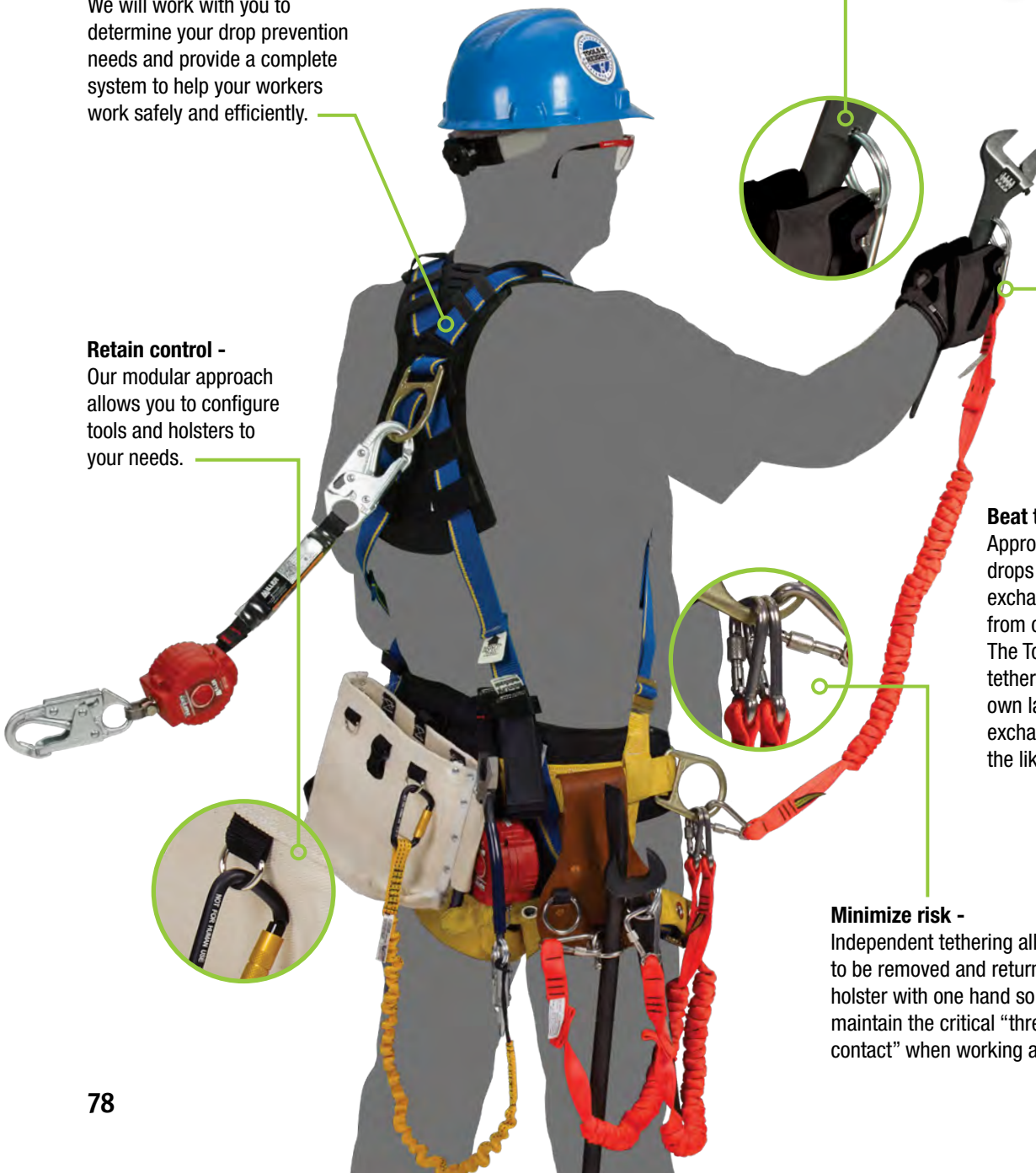

TOOLS@HEIGHT™

EFFECTIVE, RELIABLE DROP PREVENTION

WILLIAMS® OFFERS A FULL LINE OF TOOLS FOR WORKING AT HEIGHT

Rotating Screwdriver Tabs

- Located for secure retention allowing full use of the screwdriver handle
- Stainless steel tab is corrosion resistant and rotates freely 360° so the lanyard does not wrap around the users hand
- Nylon bushing has a shoulder so the tab will not bind between the handle and shank bolster



Sliding Wrench Safety Coils

- Superior design with high performance polished stainless steel for superior flexibility and shock-absorbing qualities plus no welds to fail
- Seven different sizes are utilized in the program to support wrenches up to 1-1/2" or 55mm (coils not sold separately)
- Slides out of the way along the wrenches handle to provide full use and achieve greatest leverage



Pinned Tang on Pipe Wrenches

- Pin secures the tang so that it cannot become separated from the handle



Spring Loaded Lock Buttons for Square Drive Tools and Accessories

- Lock button engages with side lock holes in sockets, extensions, and adaptors ensuring positive retention
- Sockets, extensions, and adaptors feature a locking hole on all four sides, not just one, as found on typical competitor's sockets

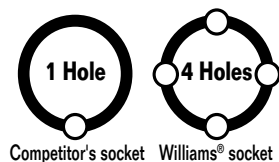

THPRTA Pin Release Tool for Williams® Square Drive Tools

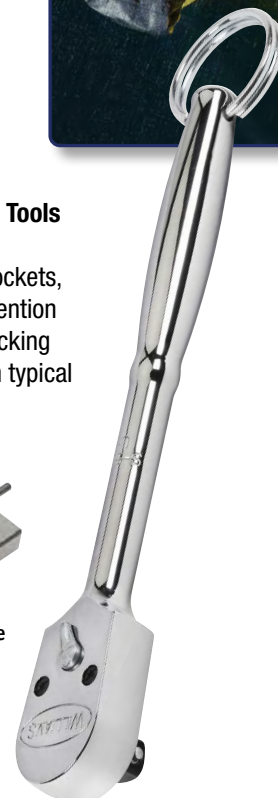

TOOLS@HEIGHT™ MASTER MAINTENANCE TOOL SET

Contains the following tools:

Product Category	Product Category
Adjustable & Miscellaneous Wrenches	Miscellaneous Tools
Combination, Box, & Open End Wrenches	Pliers
Hammers	Pry Bars, Punches & Chisels
Hand Sockets, Ratchets, & Accessories	Screwdrivers & Nut drivers
Hex Keys & Sockets	Tool Storage
Impact Sockets & Accessories	Tools@Height Tethers, Lanyards & Specialties

Set Configurations Available

Product Code	Description
JHWSC409THB	Complete Tools@Height Master Maintenance Tool Set With Tool Boxes
JHWSC409TH	Complete Tools@Height Master Maintenance Tool Set Only

Tool Boxes Included

Product Code	Description
JHWW40TC4	40" Wide x 20" Deep 4 Drawer Top Chest
JHWW40RC7	40" Wide x 20" Deep 7 Drawer Tool Cabinet

Features

- The Tools@Height Master Maintenance set provides a great assortment of tools for all types of maintenance applications
- All tools are designed to be used with our tethering and retention systems which maintain or enhance the tools' functionality when used at height or near critical assemblies
- Productivity and safety right out of the box
- Many applications - any industry where a dropped tool could harm personnel, damage machinery or cost production time
- High level uses - drilling derricks, wind turbines, cranes, buildings, bridges, masts, powerlines, hangars, scaffold builders
- Low level uses - stop tools dropping onto flight hardware, into engines, machinery, food production lines, vats, mine shafts, even under water uses
- Set is available with foamed tool control drawers on a special order basis
- Tools@Height sets contain an assortment of pouches and lanyards designed for use with a suitable belt such as the Comfort and Utility belts on page 96

JHWW40TC4



JHWW40RC7

TOOLS AT HEIGHT

MASTER SETS

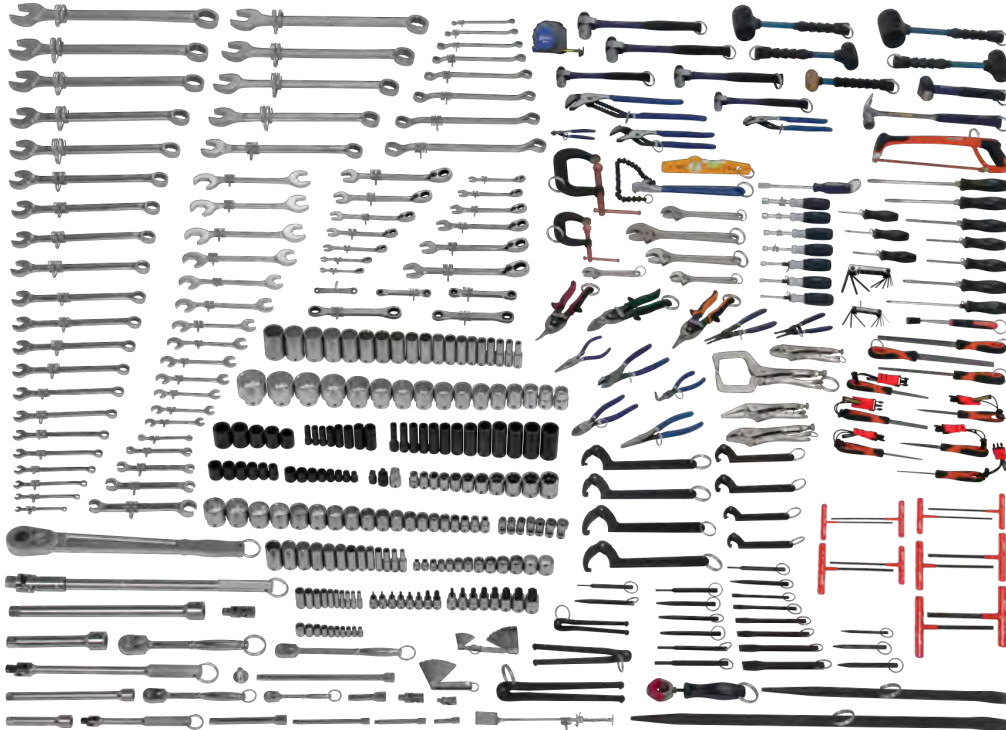

JHWSC409TH



JHWW26TC4



JHWW26RC7

TOOLS@HEIGHT™ INTERMEDIATE MAINTENANCE SERVICE SET

Contains the following tools:

Product Category	Product Category
Adjustable & Miscellaneous Wrenches	Miscellaneous Tools
Combination, Box, & Open End Wrenches	Pliers
Hammers	Pry Bars, Punches & Chisels
Hand Sockets, Ratchets, & Accessories	Screwdrivers & Nut drivers
Hex Keys & Sockets	Tool Storage
Impact Sockets & Accessories	Tools@Height Tethers, Lanyards, & Specialties

Set Configurations Available

Product Code	Description
JHWSC225HTB	Complete Tools@Height Intermediate Tool Set With Tool Boxes
JHWSC225TH	Complete Tools@Height Intermediate Tool Set Only

Tool Boxes Included

Product Code	Description
JHWW26TC4	26" Wide x 20" Deep 4 Drawer Top Chest
JHWW26RC7	26" Wide x 20" Deep 7 Drawer Tool Cabinet

Features

- The Tools@Height Intermediate Maintenance set provides a full complement of tools
- All tools are designed to be used with our tethering and retention systems which maintain or enhance the tools' functionality when used at height or near critical assemblies
- Productivity and safety right out of the box
- Many applications - any industry where a dropped tool could harm personnel, damage machinery or cost production time
- High level uses - drilling derricks, wind turbines, cranes, buildings, bridges, masts, powerlines, hangars, scaffold builders
- Low level uses - stop tools dropping onto flight hardware, into engines, machinery, food production lines, vats, mine shafts, even under water uses
- Set is available with foamed tool control drawers on a special order basis
- Tools@Height sets contain an assortment of pouches and lanyards designed for use with a suitable belt such as the Comfort and Utility belts on page 96

TOOLS AT HEIGHT

MASTER SETS



JHWSC225TH

TOOLS@HEIGHT™ GENERAL MAINTENANCE SERVICE SET

Contains the following tools:

Product Category	Product Category
Adjustable & Miscellaneous Wrenches	Pliers
Combination, Box, & Open End Wrenches	Pry Bars, Punches & Chisels
Hammers	Screwdrivers & Nut drivers
Hand Sockets, Ratchets, & Accessories	Tool Storage
Hex Keys & Sockets	Tools@Height Tethers, Lanyards, & Specialties
Miscellaneous Tools	

Set Configurations Available

Product Code	Description
JHWSC116THB	Complete Tools@Height General Service Tool Set With Tool Box
JHWWSC116TH	Complete Tools@Height General Service Tool Set Only

Tool Boxes Included

Product Code	Description
JHW50950B	32" Wide x 19" Deep Job Site Box

Features

- The Tools@Height General Maintenance Service set provides a solid complement of tools
- All tools are designed to be used with our tethering and retention systems which maintain or enhance the tools' functionality when used at height or near critical assemblies
- Productivity and Safety right out of the box
- Many applications - any industry where a dropped tool could harm personnel, damage machinery or cost production time
- High level uses - drilling derricks, wind turbines, cranes, buildings, bridges, masts, powerlines, hangars, scaffold builders
- Low level uses - stop tools dropping onto flight hardware, into engines, machinery, food production lines, vats, mine shafts, even under water uses
- Set is available with foamed tool control drawers on a special order basis
- Tools@Height sets contain an assortment of pouches and lanyards designed for use with a suitable belt such as the Comfort and Utility belts on page 96



TOOLS AT HEIGHT

MASTER SETS



JHWWSC116TH





TOOLS@HEIGHT™ BASIC MAINTENANCE SERVICE SET

Contains the following tools:

Product Category	Product Category
Adjustable & Miscellaneous Wrenches	Miscellaneous Tools
Combination, Box, & Open End Wrenches	Pliers
Hammers	Pry Bars, Punches & Chisels
Hand Sockets, Ratchets, & Accessories	Screwdrivers & Nut drivers
Hex Keys & Sockets	Tools@Height Tethers, Lanyards, & Specialties

Set Configurations Available

Product Code	Description
JHWWS-72-TH	Complete Tools@Height Basic Maintenance Tool Set in Safe Bucket

Features

- Furnished in Safe Bucket for easy portability
- Safety right out of the box
- The Tools@Height Basic Maintenance set provides a good start to a Tools@Height tool program
- All tools are designed to be used with our tethering and retention systems which maintain or enhance the tools' functionality when used at height or near critical assemblies
- Many applications - any industry where a dropped tool could harm personnel, damage machinery or cost production time
- High level uses - drilling derricks, wind turbines, cranes, buildings, bridges, masts, powerlines, hangars, scaffold builders
- Low level uses - stop tools dropping onto flight hardware, into engines, machinery, food production lines, vats, mine shafts, even under water uses
- Williams' Tools@Height sets contain an assortment of pouches and lanyards designed for use with a suitable belt
- An assortment of Comfort and Utility belts can be found on page 96
- The full assortment of Tools@Height lanyards, tethers, and other accessories is on pages 91 through 97

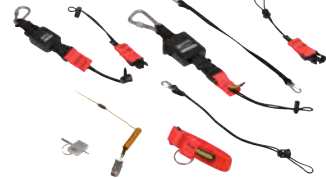

JHWWS-72-TH

TOOL@HEIGHT™ STARTER PLUS SET

Contains the following tools:

Product Category
Adjustable Wrenches
Combination Wrenches
File
Hammer
Hand Sockets, Ratchets & Accessories
Pick up Tool
Pliers
Screwdriver
Tape Measure
Tools@Height Tethers, Lanyards & Specialties
Grand Total

Set Configurations Available

Product Code	Description
WSC-45-TH	Complete Tools@Height Starter Set in Safe Bucket

Features

- The ideal way to start a drop prevention program
- Use where dropped tools can harm personnel, damage components, or cause down time
- Excellent assortment of basic hand tools for most maintenance applications
- Furnished in Safe Bucket for easy portability



WSC-45-TH

TOOL@HEIGHT™ STARTER SET

Contains the following tools:

Product Category
Adjustable Wrenches
File
Hammer
Pick up Tool
Pliers
Screwdriver
Tape Measure
Tools@Height Tethers, Lanyards & Specialties

Set Configurations Available

Product Code	Description
JHWWSC-27-TH	Complete Tools@Height Starter Set in Safe Bucket

Features

- Ideal for general maintenance work in the factory or job site
- All tools are designed to be used with our tethering and retention systems which maintain or enhance the tools' functionality when used at height or near critical assemblies.
- Includes tools and assortment of pouches and lanyards designed for use with a suitable belt.
- Williams' Tools@Height sets contain an assortment of pouches and lanyards designed for use with a suitable belt
- An assortment of Comfort and Utility belts can be found on page 96
- The full assortment of Tools@Height lanyards, tethers, and other accessories is on pages 91 through 97



JHWWSC-27-TH



KWTIWWKIT

TOOLS AT HEIGHT

MASTER SETS

TOOLS@HEIGHT™ IRONWORKER'S TOOLKIT

Contains the following tools:

Product Category	Product Category
Pliers	Hammer
Adjustable Construction Wrench	Measuring Tape
Structural Wrench	Tools@Height Tethers, Lanyards & Specialties
Bull Pin	

Set Configurations Available

Product Code	Description
KWTIWWKIT	Ironworker's Tool Kit

Features

- All tools are designed to be used with our tethering and retention systems which maintain or enhance the tools' functionality when used at height or near critical assemblies
- Tool Kit includes the tools, tethers, lanyards needed for ironworkers to work at height



KWTBM

TOOLS@HEIGHT™ BOILMAKER'S TOOL KIT

Contains the following tools:

Product Category	Product Category
Pliers	Torpedo Level
Adjustable Construction Wrench	Hammer
Open End Structural Wrench	Measuring Tape
Bull Pin	Tools@Height Tethers, Lanyards & Specialties

Set Configurations Available

Product Code	Description
KWTBM	Boilmaker's Tool Kit

Features

- All tools are designed to be used with our tethering and retention systems which maintain or enhance the tools' functionality when used at height or near critical assemblies
- Tool Kit includes the tools, tethers, lanyards needed to keep boilmakers safe and productive while working at height



KWTHRSGHR

TOOLS AT HEIGHT

MASTER SETS

TOOLS@HEIGHT™ HRSG HIGH RIGGING TOOLKIT

Contains the following tools:

Product Category	Product Category
Pliers	Hammer
Adjustable Construction Wrench	Measuring Tape
Open End Structural Wrench	Sleever Bar
Bull Pin	Tools@Height Tethers, Lanyards & Specialties
Torpedo Level	

Set Configurations Available

Product Code	Description
KWTHRSGHR	HRSG High Rigging Toolkit

Features

- All tools are designed to be used with our tethering and retention systems which maintain or enhance the tools' functionality when used at height or near critical assemblies
- Tool kit includes bull pin, sleeve bars, wrenches, hammer, torpedo level, measuring tape and many more tools with attachment points along with the tethers and lanyards for working at height

TOOLS@HEIGHT™ PIPEFITTER'S FOREMAN'S TOOLKIT

Contains the following tools:

Product Category	Product Category
Combination Wrenches	Pinch Bar
Sockets	Hex Keys
Drive Tools	Tape Measure
Screwdrivers	Tool Box
Files	Pin Release Tool
Hammer	Tool Pouch

Set Configurations Available

Product Code	Description
KWTPFFOR	Pipefitter's Foreman's Toolkit

Features

- All tools are designed to be used with our tethering and retention systems which maintain or enhance the tools' functionality when used at height or near critical assemblies
- Pipefitter's Foreman's Tool kit includes sockets, drive tools, combination wrenches, screwdrivers and many more tools with attachment points for working at height



KWTPFFOR

TOOLS@HEIGHT™ INDIVIDUAL PIPEFITTER'S TOOLKIT

Contains the following tools:

Product Category	Product Category
Wedges	Adjustable Wrenches
Utility Superjoint Pliers	Measuring Tape
Side Cutters	Tools@Height Tethers, Lanyards & Specialties

Set Configurations Available

Product Code	Description
KWTPFIND	Individual Pipefitter's Toolkit

Features

- All tools are designed to be used with our tethering and retention systems which maintain or enhance the tools' functionality when used at height or near critical assemblies
- Individual Pipefitter's Tool kit includes wedges, pliers, side cutters, hammers, adjustable wrenches and many more tools with attachment points along with the tethers and lanyards for working at height



KWTPFIND

TOOLS@HEIGHT™ PIPEFITTER'S GANG BOX KIT

Contains the following tools:

Product Category	Product Category
Utility Superjoint Pliers	Chisels & Punches
Side Cutters	Ratchet
Adjustable Wrenches	Pipe Wrench
Measuring Tape	Plastic Tool Box
Hammers	

Set Configurations Available

Product Code	Description
KWTPFBOX	Pipefitter's Gang Box Kit

Features

- All tools are designed to be used with our tethering and retention systems which maintain or enhance the tools' functionality when used at height or near critical assemblies
- Pipefitter's Gang Box Kit includes pliers, hammer, adjustable wrenches and many more tools with attachment points for working at height



KWTPFBOX

TOOLS@HEIGHT™ INDIVIDUAL ELECTRICIAN'S TOOLKIT

Contains the following tools:

Product Category	Product Category
Pliers, Side Cutter & Crimper	Files
Screwdrivers	Superjoint Pliers
Adjustable Wrenches	Hammers
Chisels & Punches	Hex Key
Hacksaw Frame	Measuring Tape
Torpedo Level	Tools@Height Tethers, Lanyards & Specialties
Miscellaneous Tools	

Set Configurations Available

Product Code	Description
KWTELEKITM	Individual Electrician's Toolkit with S/M Comfort Belt
KWTELEKITL	Individual Electrician's Toolkit with L/XL Comfort Belt
KWTELEKITXL	Individual Electrician's Toolkit with 2X/3X Comfort Belt

Features

- All tools are designed to be used with our tethering and retention systems which maintain or enhance the tools' functionality when used at height or near critical assemblies
- The Individual Electrician's Toolkit contains an assortment of tools with engineered attachment points, tethers and lanyards designed to keep electrician's safe and productive while working at heights



KWTELEKITM



KWTELECWKT

TOOLS@HEIGHT™ ELECTRICIAN CREW KIT

Contains the following tools:

Product Category	Product Category
C-Clamps	Pin Release Tool
Pliers	Sockets
Pipe Wrenches	Combination Wrenches
Files	Level
Hammer	Lift Bucket & Hardhat Lanyard Strap
Drive Tools	

Set Configurations Available

Product Code	Description
KWTELECWKT	Electrician's Crew Kit

Features

- All tools are designed to be used with our tethering and retention systems which maintain or enhance the tools' functionality when used at height or near critical assemblies
- The Electrician's Crew Kit contains an assortment of tools with engineered attachment points, tethers and lanyards designed to keep electrician's safe and productive while working at heights



TOOLS@HEIGHT™ SCAFFOLD BUILDING KITS

Kit comes assembled and includes tools shown above. Scaffold builders literally open the box, put on the belt, and go to work with a kit that keeps them safe and increases productivity. Since each tool is independently tethered, any tool can be used and returned to its' holster while still maintaining three points of contact as pictured below

Product Code	Description
JHWWTHSCAFM	Medium
JHWWTHSCAFL	Large
JHWWTHSCAFXL	X-Large

Contents of Scaffold Building Kits:

Product Code	Description
THFSNE3-22SM	Hammer
THFSN25100	Level
JHWBS-63B	Scaffold Ratchet
JHWTM25X1-TH	Tape Measure
JHW13625-TH	Construction Wrench
JHWPL204CTH	Linesman's Pliers
WTHHOLHAMMER	Hammer Holster with Coil Lanyard
PYT1500098	Tape measure Holster
PYT1500096	Scaffold Ratchet Holster w/Bungee Lanyard
PYT1500065	Single Tool Holster
PYT1500107	Dual Tool Holster
BELTCOMF	Belt (Small, Medium, Large or X-Large)
WTHPCHPRTSCO	Small Parts pouch w/ Self-closing system

Features

- Safety & Security
- Holsters are designed with built-in attachment points or retractors
- Tools are tethered to the holster at all times so the risk of dropping a tool while transferring from bag to lanyard is eliminated
- Several holsters also feature hook and loop flaps that secure the tool while being transported
- Customizable
- System is completely modular and can be arranged in any order on the tool belt based on the user's preference
- All Tools @ Height holsters and pouches are also available for individual purchase for attachment to existing tool belts or harnesses





EXTH2LBU10PK



EXT2T.5X12



THCARA25A



THCARA15SL



THUNI25A

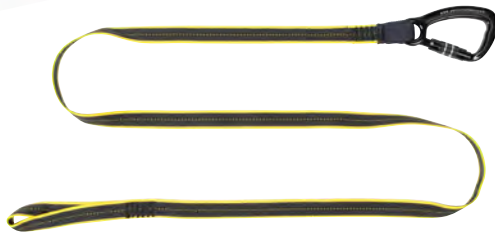

EXTH2L1X72HD



EXTH2R1X72HD



THL2A



EXTH2L1X72MD



THL1A

LANYARDS AND ANCHOR STRAPS

Product Code	Description	Load Rating (lbs)	Extension Length (Inches)	Retracted Length (Inches)	QTY
EXTH2LBU10PK	Carabiner to loop bungee lanyard, Standard Duty 10 pack	10	47	31	10
EXT2T.5X12	Trigger to trigger web lanyard, Standard Duty	10	12	n/a	1
EXT2T51210P	Trigger to trigger web lanyard, Standard Duty 10 pack	10	12	n/a	10
THCARA25A	SST Carabiner to Carabiner Bungee Lanyard, Medium Duty	25	124	37-45	1
THCARA15SL	SST Carabiner to Carabiner Bungee Lanyard, Standard Duty	15	47	27	1
THUNI25A	SST Carabiner to Loop Bungee Lanyard, Standard Duty	15	50	30	1
EXTH2L1X72HD	Carabiner to loop web lanyard, Heavy Duty	80	72	n/a	1
EXTH2R1X72HD	Carabiner to rail hook web lanyard, Heavy Duty	80	72	n/a	1
EXTH2L1X72MD	Carabiner to loop web lanyard, Medium Duty	35	72	n/a	1
THL1A	Universal Tether with Carabiner and Loop	5	14	n/a	1
THL2A	Universal Tether with 2 SST Carabiners	5	14	n/a	1

* Tool Lanyards not included with Tool Holsters unless otherwise stated. Tools not included with Tool Holsters.

TOOLS AT HEIGHT

LANYARDS/ANCHOR STRAPS



EXT-H2HCOIL



EXT-T2TCOIL



EXT-H2QRCOIL



EXTC2CCO10PK



EXTC2LCO10PK



PYT1500062

COIL TETHERS

Product Code	Description	Load Rating (lbs)	Extension Length (Inches)	Retracted Length (Inches)	QTY
EXT-H2HCOIL	Patented carabiner to carabiner vinyl coated braided steel tether, Personal Duty	5	67 ½	16 ½	1
EXTH2HCO10PK	Carabiner to carabiner vinyl coated braided steel tether, Personal Duty 10 pack	5	67 ½	16 ½	10
EXT-T2TCOIL	Trigger to Trigger tether, Personal Duty	5	30	9	1
EXTT2TCOI10P	Trigger to Trigger tether, Personal Duty 10 pack	5	30	9	10
EXT-H2QRCOIL	Carabiner to quick ring tether, Personal Duty	2	65 ½	25	1
EXTH2QRC10PK	Carabiner to quick ring tether, Personal Duty 10 pack	2	65 ½	25	10
EXTC2CCO10PK	Clip to clip tether, Personal Duty 10 pack	2	44	9	10
EXTC2LCO10PK	Clip to side release loop tether, Personal Duty 10 pack	2	45 ¼	10	10
PYT1500062	Clip to loop hard hat tether 100 pack	2	44 ½	12	100

TOOLS AT HEIGHT

COIL TETHERS/RETRACTABLE TETHERS



THUNIRET2A



THRET2CLIPSA



THUNIRET1A



THWSRET1A



THUNI5CLIPSA



THUNIRET3.5

RETRACTABLE TETHERS

Product Code	Description	Load Rating (lbs)	Extension Length (Inches)	Retracted Length (Inches)	QTY
THUNIRET2A	2 LB Retractable Lanyard	2	42	17	1
THRET2CLIPSA	Disconnectable Clips/Loop for THUNIRET2A, 10pk	2	N/A	8	10
THUNIRET1A	Self Flushing Retractable Tether with Disconnectable Loop	1	36	14	1
THRET1CLIPSA	Disconnectable Clips/Loop for THUNIRET1A and THWSRET1A, 10pk	1	N/A	7-3/4	10
THWSRET1A	Personal Duty Retractable Tether	1	49	10	1
THUNI5CLIPSA	Disconnectable Clips/Loop, 10 Pack	5	N/A	-	10
THUNIRET3.5	3.5 LB Retractable Lanyard	3.5	55	11.75	1



PULLAWAY WRISTBANDS

Product Code	Size	Load Rating (lbs)	QTY
WB-S	Small	5	1
WB-S-10PK	Small	5	10
WB-M-10PK	Medium	5	10
WB-L	Large	5	1
WB-L-10PK	Large	5	10
WB-SLIMS10PK	Slim / Small	5	10
WB-SLIMM10PK	Slim / Medium	5	10
WB-SLIML10PK	Slim / Large	5	10

Features

- Pullaway wristbands are designed so that they can be escaped from in emergency situations
- Pullaway Wristbands feature an elastic strap that conform to the users wrist size automatically



ADJUSTABLE WRISTBANDS

Product Code	Load Rating (lbs)	QTY
THWSNC	5	1
THWS1A	5	1
WB-ADJ-10PK	5	10
WBADJCRD10PK	5	10
WBADJRET10PK	1.5	10
THWSRET1A	1	1

Features

- Adjustable Wristbands can be sized to virtually any wrist size with Hook and Loop closure straps

Tools not included with Wristbands.

TOOLS AT HEIGHT

WRIST BANDS



HARD HAT TETHERS

Product Code	Weight Rating	Extension Length (Inches)
THHARDHAT1	1 lb 2 oz	16
THHARDHAT2	1 lb 2 oz	14

Features

- Retractor provides a lower-profile and more comfortable method of hard hat tethering
- Weight Rating: 1lb. 2oz.
- Looped end cinches around hard hat
- Spring clip attaches to clothing or vest to secure hat



PYT1500089



HOL-BOTTLE



HOL-HAMMER



HOL1TOOLBLTR



HOL-1TOOLHAR



HOL-1TOOLXD



HOL2TOOLBLTR



HOL-2TOOLHAR



HOLBOXWHARR



HOLSCAFFWRET



PYT1500100



RET-52STEEL



PYT1500090

TOOLS AT HEIGHT

HOLSTERS

TOOL HOLSTERS

Product Code	Description	Product Code	Description
HOL-ADJRADIO†	Adjustable Radio Holster	HOL-2TOOLHAR	Dual Tool Harness Holster
PYT1500089	Adjustable Radio Holster Combo (Includes EXT-C2LCOIL)	HOL2TOOLHARR†	Dual Tool Harness Holster with Retractors
HOL-BOTTLE	Bottle / Spray Can Holster	HOLBOXWHARR	Box Wrench Holster with Retractor (Harness)
HOL-HAMMER†	Hammer Holster	HOLSCAFFWRET†	Scaffold Wrench Holster with Retractor
HOLHAMMERCOM	Hammer Holster Combo (Includes EXT-H2QRCOIL)	HOLSCAFFWCOM	Scaffold Wrench Holster with Retractor Combo (Includes EXTH2LBUNGEE)
HOL-1TOOLBLT	Single Tool Belt Holster	HOL-TAPERET†	Tape Measure Holster with Retractor
HOL1TOOLBLTR†	Single Tool Belt Holster with Retractor	HOLTAPESLEEVE†	Tape Measure Sleeve
HOL-1TOOLHAR	Single Tool Harness Holster	PYT1500100	Tape Measure Holster with Retractor Combo (Includes HOLTAPESLEEVE)
HOL1TOOLHARR†	Single Tool Harness Holster with Retractor	RET-52STEEL	52' Steel Cable Retractor with Polycarbonate Body
HOL-1TOOLXD†	Extra-Deep Single Tool Holster	PYT1500090	Cordless Tool Battery Holster (Shown with EXTH2LBUNGEE not included)
HOL-2TOOLBLT	Dual Tool Belt Holster		
HOL2TOOLBLTR†	Dual Tool Belt Holster with Retractors		

* Tool Lanyards not included with Tool Holsters unless otherwise stated. Tools not included with Tool Holsters. †Patent Pending



PCH-PARTS-CC

SMALL PARTS POUCH

Product Code	Description
PCH-PARTS-CB	Small Parts Pouch - Canvas Black
PCH-PARTS-CC	Small Parts Pouch - Canvas Camo
PCH-PARTS-CO	Small Parts Pouch - Canvas Orange
PCH-PARTS-VY	Small Parts Pouch - Vinyl Yellow
PCHPARTSXDCB	Small Parts Pouch Extra-Deep - Canvas Black

Features

- The patented Small Parts Pouch stops accidental drops with an innovative self-closure system that traps objects inside making it nearly impossible for objects to fall out once placed in the bag
- Easy to retrieve objects since no opening or closing is necessary
- Available in several colors, and a vinyl variant
- Extra-deep Small Parts Pouch is also available for extra storage space



PYT1500132

UTILITY POUCH

Product Code	Description
PYT1500132	Utility Pouch

Features

- Two welded D-Rings on front of pouch to tie off tools
- One additional D-Ring inside pouch
- Two inner pouch pockets for storing tools
- Belt loop on back of pouch
- Two side ears are perfect for holding spud wrenches and sleeve bars
- Drain vent on the bottom of the pouch



PCH-INSPECT

INSPECTION POUCH

Product Code	Description
PCH-INSPECT	Inspection Pouch

Features

- Provisional patent pending



PCH-TOOL

PCH-TOOLXD

EXTH2LBUNGEE

TOOL POUCHES

Product Code	Description
PCH-TOOL	Tool Pouch with D-Ring
PCH-TOOLRET	Tool Pouch with D-Ring and Retractors
PCH-TOOLTRIG	Tool Pouch with D-Ring and Triggers
PCH-TOOLXD	Extra Deep Tool Pouch with D-Ring
PCH-TOOLXDRE	Extra Deep Tool Pouch with D-Ring and Retractors
PCH-TOOLXDTR	Extra Deep Tool Pouch with D-Ring and Triggers

Tools not included with Tool Holsters.

COMFORT TOOL BELTS

Product Code	Waist Size (Inches)
BELTCOMF-S	28" - 32"
BELTCOMF-M	32" - 36"
BELTCOMF-L-XL	36" - 44"
BELTCOMF-2XL	44" - 48"
BELTCOMF-3XL	48" - 52"

Features

- A drop prevention tool belt system that's both durable and comfortable
- Modular design allowing the user to customize their own personal holster and pouch set up



BELTCOMF-S

UTILITY BELTS

Product Code	Waist Size (Inches)
PYT1500113	28" - 46"
PYT1500114	40" - 54"

Features

- Utility tool belt features a high strength grommet closure system with padding inside two layers of cordura that provides for durability and comfort



PYT1500113

BELT LOOPS

Product Code	Description	Load Rating (lbs)	QTY
BELDRLO10PK	Belt Loop D-Ring	5	10
BELTRLO10PK	Belt Loop Trigger	5	10

Features

- Compatible with all tool belts above
- D-Ring Belt Loop Attachment creates an instant attachment point that is third-party load-rated for 5 lbs.
- Belt Loop Trigger creates an instant staging point that is third-party load-rated for 5 lbs. A thumb release steel trigger snap allows for quick tool transfers while maintaining a secure connection, even while wearing work gloves. Modular design allowing the user to customize their own personal holster and pouch set up.



BELDRLO10PK



BELTRLO10PK



PYTH1500139



BKT-100HLC



BKT-48SCAF

SAFE BUCKETS

Product Code	Closure System	Body Material	Load Rating (lbs)
BKT-100HLC	Hook and Loop	Canvas	100
BKT-100DRAWC	Drawstring	Canvas	100
PYT1500140	Hook and Loop	Vinyl	250
PYT1500139	Drawstring	Vinyl	250

Features

- Every Safe Bucket is manufactured with either a hook and loop or drawstring closure system which helps prevent accidental drops
- All Safe Buckets are third-party load rated
- Sewn into the bottom of every Safe Bucket is hard composite plating that protects the bucket from accidental punctures. A protective leather sleeve covers the inserts that is resilient to the elements and harsh work environments.
- The Safe Bucket was engineered to be used with tools at height, and includes multiple connection points that can be tethered to. Workers can tether their tools directly to the Safe Bucket when being used, and store their tools for transport when finished.
- Instead of rope which is susceptible to fraying, a heavy-duty hoisting/shoulder strap is built into every Safe Bucket. Each bucket is also equipped with a high-quality and lightweight aluminum twist-lock carabiner load rated for 30 kN (6,700 lbs). There is no need to worry about a knot failing, or a non-locking carabiner which may slip off a connection point.
- Safe Buckets are 15 inches tall and have a 12.5 inch Diameter



BKT-HBINSERT

HARD BODY SAFE BUCKET INSERT

Product Code
BKT-HBINSERT

Features

- The Hard Body Safe Bucket Insert converts the standard soft body Safe Bucket into a hard body bucket with four inner pockets for staging tools and small parts. The insert can be removed and reused, and is compatible with all standard Safe Buckets

Tools not included

EXTRA DEEP SAFE BUCKETS

Product Code	Length (Inches)	Load Rating (lbs)
BKT-48SCAF	48	100
BKT-72SCAF	72	100
BKT-120SCAF	120	100

Features

- Extra Deep Safe Buckets feature a hook and loop closure system allowing for the safe transport of scaffold poles and large tools
- Available in three different lengths
- Third-party load rated for 100 pounds
- A heavy duty webbing hoisting strap comes with a built in twist-lock aluminum carabiner for lifting



TOOLS@HEIGHT™ SUPERCOMBO® COMBINATION WRENCHES

High Polish Chrome and Satin Chrome Finish, 12 Point, SAE

Product Code	Size (Inches)	A Overall Length (Inches)	B Open End Width (Inches)	C Open End Thickness (Inches)	D Box End Diameter (Inches)	E Box End Thickness (Inches)	Weight (lbs)
JHW120SC-TH +	1/4	4 1/4	9/16	1/8	13/32	3/16	0.04
JHW1210SC-TH +	5/16	5 3/4	11/16	5/32	1/2	7/32	0.08
JHW1212SC-TH ++	3/8	6 1/2	13/16	3/16	9/16	1/4	0.12
JHW1214SC-TH ++	7/16	7 1/4	15/16	7/32	11/16	9/32	0.17
JHW1216SC-TH ++	1/2	8	1 1/16	1/4	3/4	11/32	0.23
JHW1218SC-TH ++	9/16	8 3/4	1 1/4	1/4	7/8	3/8	0.31
JHW1220SC-TH ++	5/8	9 1/2	1 3/8	9/32	15/16	13/32	0.43
JHW1222SC-TH ++	11/16	10 1/4	1 1/2	5/16	1 1/32	7/16	0.51
JHW1224SC-TH ++	3/4	11	1 5/8	5/16	1 1/8	1/2	0.62
JHW1226SC-TH ++	13/16	11 3/4	1 3/4	3/8	1 7/32	17/32	0.79
JHW1228SC-TH ++	7/8	12 1/2	1 7/8	13/32	1 5/16	9/16	0.96
JHW1230SC-TH ++	15/16	13 1/4	2	7/16	1 3/8	19/32	1.20
JHW1232SC-TH ++	1	14	2 1/8	15/32	1 15/32	5/8	1.48
JHW1234SC-TH ++	1 1/16	14 3/4	2 1/4	1/2	1 9/16	21/32	1.65
JHW1236SC-TH ++	1 1/8	15 1/2	2 13/32	17/32	1 21/32	11/16	1.94
JHW1240SC-TH ++	1 1/4	17	2 21/32	9/16	1 13/16	3/4	2.58
JHW1242-TH **	1 5/16	17 3/4	2 19/16	19/32	1 29/32	3/4	2.96
JHW1244-TH **	1 3/8	18 1/2	2 15/16	5/8	2	3/4	3.45
JHW1246-TH **	1 7/16	19 1/4	3 1/16	5/8	2 3/32	7/8	3.85
JHW1248-TH **	1 1/2	20 1/2	3 3/16	11/16	2 3/16	7/8	4.29
JHW1180-TH **	1 5/8	21 1/2	3 5/16	11/16	2 11/32	7/8	3.70
JHW1182-TH **	1 11/16	22 9/32	3 7/16	23/32	2 7/16	7/8	5.22
JHW1184-TH **	1 3/4	22 7/8	3 9/16	23/32	2 17/32	1 1/32	5.62
1186-TH **	1 13/16	23 15/32	3 11/16	3/4	2 5/8	1 1/32	6.34
1188-TH **	1 7/8	24 1/32	3 13/16	25/32	2 23/32	1 1/32	6.92
1190-TH **	2	25 1/4	4 1/16	27/32	2 7/8	1 1/32	8.20



JHW1222SC-TH



JHW1180-TH

WS-6-TH 6 Piece Supercombo Combination Wrench Set 2.27 LBS

Contents Include:

Product Code	Size (Inches)	Product Code	Size (Inches)	Product Code	Size (Inches)
JHW1214SC-TH	7/16	JHW1218SC-TH	9/16	JHW1222SC-TH	11/16
JHW1216SC-TH	1/2	JHW1220SC-TH	5/8	JHW1224SC-TH	3/4

- + High Polish Chrome Finish with SUPERTORQUE® Box End.
- ++ High Polish Chrome Finish with SUPERCOMBO® Open End and SUPERTORQUE® Box End.
- ** Satin Chrome Finish with SUPERTORQUE® Box End and Standard Open End.
- * Satin Chrome Finish with Standard Open and Box Ends.
- Fed. Spec.: ANSI B107.6; SAE AS 954



WS-6-TH

TOOLS AT HEIGHT

WRENCHES

Features

- SUPERCOMBO® open end has specially designed grooves that direct wrench force away from fastener corners
- SUPERTORQUE® box opening design allows application of higher torque without rounding or deforming hex fastener points. No contact is made at the corners. Instead, wrenching forces are placed on the flat surfaces behind the points
- Meets or exceeds aerospace specification AS 954 for 12 point fasteners (as defined by AS 870) to provide accurate torque/tension relationship for precision application
- May be used on all common hex (6 point) fasteners with considerable advantage over conventional box end wrenches to increase both hand tool flexibility and economy
- Box and open end openings are identical



Wrench with Safety Coil -
Secure lanyard attachments need to withstand tough site use, including low temperature, so structural integrity is critical

- Superior Design - No welds to fail
- High Performance - Made from polished stainless steel, they have superior flexibility and shock-absorbing qualities over welded attachments
- Seven sizes available to support wrenches up to 1 1/2" or 55mm
- Slides out of the way along the wrenches handle to provide full use of the handle and achieve greatest leverage

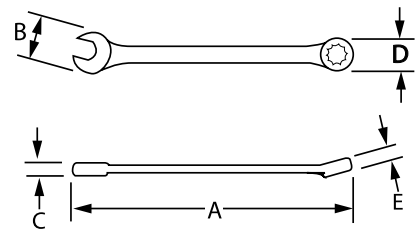

Be sure to use a lanyard that has more weight capacity than the tool you are attaching because drop forces are greater than actual tool weight.



TOOLS@HEIGHT™ SUPERCOMBO® COMBINATION WRENCHES

High Polish Chrome Finish, 12 Point, Metric



JHW1215MSCTH

Product Code	Size (Inches)	A	B	C	D	E	Weight (lbs)
		Overall Length (Inches)	Open End Width (Inches)	Open End Thickness (Inches)	Box End Diameter (Inches)	Box End Thickness (Inches)	
JHW1207MSCTH ++	7	5 5/16	5/8	5/32	15/32	7/32	0.06
JHW1208MSCTH ++	8	5 25/32	23/32	5/32	1/2	7/32	0.08
JHW1209MSCTH ++	9	6 9/32	13/16	3/16	9/16	1/4	0.10
JHW1210MSCTH ++	10	6 3/4	7/8	3/16	5/8	9/32	0.13
JHW1211MSCTH ++	11	7 1/4	31/32	7/32	11/16	9/16	0.18
JHW1212MSCTH ++	12	7 11/16	1 1/32	7/32	3/4	9/16	0.20
JHW1213MSCTH ++	13	8 1/32	1 1/8	1/4	25/32	11/32	0.23
JHW1214MSCTH ++	14	8 5/8	1 7/32	1/4	27/32	3/8	0.32
JHW1215MSCTH ++	15	9 3/32	1 9/32	9/32	29/32	13/32	0.35
JHW1216MSCTH ++	16	9 1/2	1 3/8	9/32	15/16	13/32	0.41
JHW1217MSCTH ++	17	10 1/16	1 15/32	5/16	1	7/16	0.47
JHW1218MSCTH ++	18	10 17/32	1 17/32	5/16	1 1/16	15/32	0.56
JHW1219MSCTH ++	19	11 1/32	1 5/8	11/32	1 1/8	1/2	0.67
JHW1220MSCTH ++	20	11 1/2	1 29/32	3/8	1 3/16	1/2	0.77
JHW1221MSCTH ++	21	11 25/32	1 3/4	3/8	1 7/32	17/32	0.82
JHW1222MSCTH ++	22	12 1/2	1 29/32	13/32	1 9/16	9/16	1.08
JHW1223MSCTH ++	23	12 7/8	1 31/32	7/16	1 11/32	9/16	1.08
JHW1224MSCTH ++	24	13 9/32	2	7/16	1 3/8	19/32	1.20
JHW1225MSCTH ++	25	14 1/32	2 9/32	15/32	1 15/32	5/8	1.49
JHW1226MSCTH +	26	14 5/16	2 3/16	1/2	1 1/2	21/32	1.51
JHW1227MSCTH +	27	14 25/32	2 9/32	1/2	1 9/16	11/16	1.64
JHW1229MSCTH +	29	15 17/32	2 13/32	17/32	1 21/32	23/32	2.00
JHW1230MSCTH +	30	16 9/32	2 17/32	17/32	1 3/4	3/4	2.30
JHW1232MSCTH +	32	17 1/32	2 11/16	9/16	1 31/16	3/4	2.76
JHW1234MSCTH +	34	17 25/32	2 13/16	19/32	1 29/32	3/4	2.92
JHW1236MSCTH +	36	19 9/32	3 1/16	21/32	2 3/32	7/8	3.86

+ High Polish Chrome Finish with SUPERTORQUE® Box End

++ High Polish Chrome Finish with SUPERCOMBO® Open End and SUPERTORQUE® Box End

Fed. Spec.: ANSI B107.6; SAE AS 954



Features

- SUPERCOMBO® open end has specially designed grooves that direct wrench force away from fastener corners
- SUPERTORQUE® box opening design allows application of higher torque without rounding or deforming hex fastener points
 - No contact is made at the corners. Instead, wrenching forces are placed on the flat surfaces behind the points
- Meets or exceeds aerospace specification AS 954 for 12 point fasteners (as defined by AS 870) to provide accurate torque/tension relationship for precision application
- May be used on all common hex (6 point) fasteners with considerable advantage over conventional box end wrenches to increase both hand tool flexibility and economy
- Box and open end openings are identical

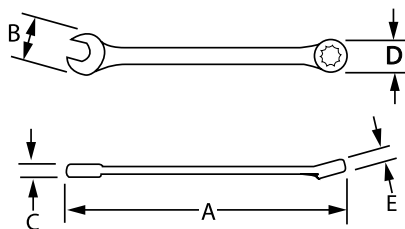

Wrench with Safety Coil –

Secure lanyard attachments need to withstand tough site use, including low temperature, so structural integrity is critical

- Superior Design - No welds to fail
- High Performance - Made from polished stainless steel, they have superior flexibility and shock-absorbing qualities over welded attachments
- Seven sizes available to support wrenches up to 1 1/2" or 55mm
- Slides out of the way along the wrenches handle to provide full use of the handle and achieve greatest leverage

TOOLS@HEIGHT™ REVERSIBLE RATCHETING COMBINATION WRENCHES

High Polish Chrome Finish, 12 Point, Metric

Product Code	Size (Inches)	A					Weight (lbs)
		Overall Length (Inches)	Open End Width (Inches)	Open End Thickness (Inches)	Box End Diameter (Inches)	Box End Thickness (Inches)	
JHW1208MRCTH	8	5 1/4	23/32	3/16	23/32	9/32	0.08
JHW1209MRCTH	9	5 7/8	13/16	5/32	29/32	5/16	0.14
JHW1210MRCTH	10	6 1/4	7/8	7/32	7/8	11/32	0.15
JHW1211MRCTH	11	6 5/8	15/16	7/32	29/32	11/32	0.22
JHW1212MRCTH	12	6 13/16	1	7/32	31/32	3/8	0.00
JHW1213MRCTH	13	7	1 1/32	1/4	1	13/32	0.36
JHW1214MRCTH	14	7 3/8	1 3/16	1/4	1 3/32	13/32	0.42
JHW1215MRCTH	15	7 3/4	1 1/4	9/32	1 5/32	7/16	0.56
JHW1216MRCTH	16	8 3/16	1 11/32	9/32	1 7/32	7/16	0.77
JHW1217MRCTH	17	9	1 7/16	9/32	1 9/32	1/2	0.93
JHW1218MRCTH	18	9 3/8	1 17/32	5/16	1 3/8	15/32	1.15
JHW1219MRCTH	19	9 3/4	1 17/32	11/32	1 7/16	17/32	1.33

Features

- High-polished chrome finish cleans easily
- Ratchet lever is easily accessible for quick direction changes
- Recessed corners in ends provide extra turning power



JHW1210MRCTH

TOOLS@HEIGHT™ REVERSIBLE RATCHETING COMBINATION WRENCHES

High Polish Chrome Finish, 12 Point, SAE

Product Code	Size (Inches)	A					Weight (lbs)
		Overall Length (Inches)	Open End Width (Inches)	Open End Thickness (Inches)	Box End Diameter (Inches)	Box End Thickness (Inches)	
JHW1208RC-TH	1/4	5 1/4	23/32	3/16	23/32	9/32	.06
JHW1210RC-TH	5/16	5 1/4	23/32	5/32	23/32	9/32	0.08
JHW1212RC-TH	3/8	6 1/4	7/8	3/16	7/8	5/16	0.10
JHW1214RC-TH	7/16	6 5/8	15/16	7/32	29/32	11/32	0.13
JHW1216RC-TH	1/2	7	1 1/32	1/4	1	13/32	0.16
JHW1218RC-TH	9/16	7 3/8	1 3/16	1/4	1 3/32	13/32	0.18
JHW1220RC-TH	5/8	8 7/32	1 11/32	9/32	1 7/32	7/16	0.00
JHW1222RC-TH	11/16	9	1 7/16	9/32	1 11/16	1/2	0.27
JHW1224RC-TH	3/4	9 3/4	1 17/32	11/32	1 15/32	17/32	0.00
JHW1226RC-TH	13/16	10 1/2	1 23/32	3/8	1 9/16	17/32	0.36
JHW1228RC-TH	7/8	11 13/32	1 7/8	11/32	1 21/32	19/32	0.44
JHW1230RC-TH	15/16	12	1 31/32	15/32	1 27/32	5/8	0.50
JHW1232RC-TH	1	13	2 3/32	15/32	1 7/8	5/8	0.56

Features

- High-polished chrome finish cleans easily
- Ratchet lever is easily accessible for quick direction changes
- Recessed corners in ends provide extra turning power



JHW1232RC-TH



Wrench with Safety Coil -

Secure lanyard attachments need to withstand tough site use, including low temperature, so structural integrity is critical

- Superior Design - No welds to fail
- High Performance - Made from polished stainless steel, they have superior flexibility and shock-absorbing qualities over welded attachments
- Seven sizes available to support wrenches up to 1 1/2" or 55mm
- Slides out of the way along the wrenches handle to provide full use of the handle and achieve greatest leverage

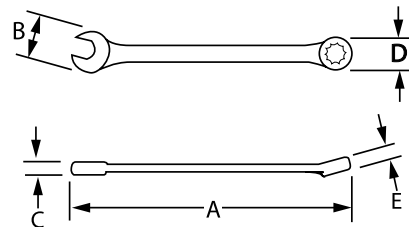

TOOLS@HEIGHT™ 15°-60° DOUBLE OPEN END ANGLE-HEAD WRENCHES

Chrome Satin Finish, SAE



JHW3732-TH

Product Code	Size (Inches)	A Head Diameter	B Head Thickness	C Overall Length (Inches)	Weight (lbs)
JHW3716-TH	1/2	1	7/32	5 1/2	0.10
JHW3718-TH	9/16	1 1/8	1/4	6	0.14
JHW3720-TH	5/8	1 3/16	9/32	6 1/4	0.14
JHW3722-TH	11/16	1 5/16	9/32	7	0.21
JHW3724-TH	3/4	1 7/16	9/32	7 1/4	0.28
JHW3726-TH	13/16	1 13/32	9/32	7 1/2	0.27
JHW3728-TH	7/8	1 21/32	9/32	8 1/4	0.35
JHW3732-TH	1	1 15/16	5/16	9 3/4	0.41
JHW3734-TH	1 1/16	2 1/16	5/16	10	0.50
JHW3736-TH	1 1/8	2 1/4	5/16	11	0.61
JHW3740-TH	1 1/4	2 3/8	11/32	11 1/2	0.70
JHW3744-TH	1 3/8	2 11/16	13/32	12 1/2	0.85
JHW3746-TH	1 7/16	2 11/16	13/32	12 1/2	1.25
JHW3748-TH	1 1/2	2 11/16	13/32	12 1/2	1.19

Fed. Spec. ANSI B107.39 Type 2 Class 3

Features

- Wrench heads are offset at 15° and 60° to the handle
- Both ends are the same size to permit the wrench to be used in four different positions
- 45° chamfer on wrench ends allow easy placement of wrench on the fastener
- Continuous arc design minimizes spreading and is stronger than "V" design
- Thin head is perfect for tight clearances
- Satin chrome finish provides good grip and cleans easily



TOOLS@HEIGHT™ DOUBLE HEAD 10° OFFSET BOX END WRENCHES

Chrome Satin Finish, 12 Point, SAE



JHW7731B-TH

Product Code	Size (Inches)	A Overall Length (Inches)	B Box End Diameter (Inches)	C Box End Thickness (Inches)	D Box End Diameter (Inches)	E Box End Thickness (Inches)	Weight (lbs)
JHW7723-TH	3/8 x 7/16	7 5/8	19/32	5/16	21/32	11/32	0.11
JHW7725B-TH	1/2 x 9/16	8 11/16	3/4	3/8	27/32	3/8	0.30
JHW7727A-TH	5/8 x 11/16	10 5/32	29/32	7/16	1	15/32	0.47
JHW7029B-TH	11/16 x 3/4	10 15/16	1	19/32	1 3/32	1/2	0.53
JHW7731A-TH	3/4 x 7/8	12 1/32	1 3/32	1/2	1 1/4	9/16	0.73
JHW7731B-TH	13/16 x 7/8	12 13/32	1 3/16	17/32	1 1/4	9/16	0.80
JHW7033C-TH	15/16 x 1	14 1/8	1 11/32	19/32	1 7/16	5/8	0.94
JHW7038-TH	1 1/8 x 1 3/16	16 3/32	1 19/32	11/16	1 11/16	11/16	1.66
JHW7039B-TH	1 1/4 x 1 5/16	17 3/8	1 29/32	23/32	1 27/32	3/4	0.00

Fed. Spec. ANSI B107.6

Features

- SUPERTORQUE® box opening design allows application of higher torque without rounding or deforming hex fastener points. No contact is made at the corners. Instead, wrenching forces are placed on the flat surfaces behind the points
- 10° offset box end allows clearance in tight areas
- Sizes are clearly marked on handle ends

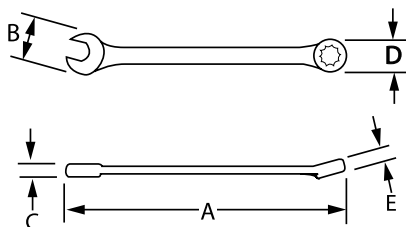

Wrench with Safety Coil -

Secure lanyard attachments need to withstand tough site use, including low temperature, so structural integrity is critical

- Superior Design - No welds to fail
- High Performance - Made from polished stainless steel, they have superior flexibility and shock-absorbing qualities over welded attachments
- Seven sizes available to support wrenches up to 1 1/2" or 55mm
- Slides out of the way along the wrenches handle to provide full use of the handle and achieve greatest leverage



TOOLS@HEIGHT™ DOUBLE HEAD 10° OFFSET BOX END WRENCHES

Chrome Satin Finish, 12 Point, Metric

Product Code	Size (MM)	A Overall Length (Inches)	B Box End Diameter (Inches)	C Box End Thickness (Inches)	D Box End Diameter (Inches)	E Box End Thickness (Inches)	Weight (lbs)
JHWBWM0810TH	8 x 10	7 5/16	1/2	9/32	19/32	5/16	0.15

Fed. Spec. ANSI B107.9M



Features

- SUPERTORQUE® box opening design allows application of higher torque without rounding or deforming hex fastener points. No contact is made at the corners. Instead, wrenching forces are placed on the flat surfaces behind the points
- 10° offset box end allows clearance in tight areas
- Sizes are clearly marked on handle ends

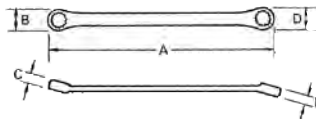

JHWBWM0810TH



TOOLS@HEIGHT™ DOUBLE HEAD FLARE NUT WRENCHES

Chrome Satin Finish, 6 Point, SAE

Product Code	Size (Inches)	A Overall Length (Inches)	B Open End Dia (Inches)	C Open End Thickness (Inches)	D Open End Dia (Inches)	E Open End Thickness (Inches)	Weight (lbs)
JHWXFN0810TH	1/4 x 5/16	4 27/32	19/32	1/4	5/8	9/32	0.12
JHWXFN1214TH	3/8 x 7/16	5 19/16	25/32	5/16	27/32	11/32	0.14
JHWXFN1618TH	1/2 x 9/16	6 13/16	15/16	3/8	1	13/32	0.23
JHWXFN2022TH	5/8 x 1 1/16	7 3/4	1 3/32	7/16	3/16	15/32	0.38
JHWXFN2432TH	3/4 x 1	9 1/2	1 1/4	1/2	19/32	5/8	0.70
JHWXFN2836TH	7/8 x 1 1/8	10.5	1 7/16	9/16	1 3/4	11/16	0.99

Fed. Spec.: ANSI B107.6

JHWS-14-TH 5 Piece Double Head Flare Nut Wrench Set, 6 Point, SAE, in Pouch - R-4 2.71 lbs

Contents Include:

Product Code	Size (Inches)	Product Code	Size (Inches)	Product Code	Size (Inches)
JHWXFN1214TH	3/8 x 7/16	JHWXFN2022TH	5/8 x 1 1/16	JHWXFN2836TH	7/8 x 1 1/8
JHWXFN1618TH	1/2 x 9/16	JHWXFN2432TH	3/4 x 1		



Features

- Will not mar fittings on pipes and tubing.
- Satin chrome textured finish provides great feel and extra gripping power
- Recessed corners in ends provide extra turning power



JHWS-14-TH

TOOLS AT HEIGHT

WRENCHES

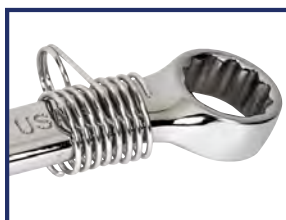

Wrench with Safety Coil -

Secure lanyard attachments need to withstand tough site use, including low temperature, so structural integrity is critical

- Superior Design - No welds to fail
- High Performance - Made from polished stainless steel, they have superior flexibility and shock-absorbing qualities over welded attachments
- Seven sizes available to support wrenches up to 1 1/2" or 55mm
- Slides out of the way along the wrenches handle to provide full use of the handle and achieve greatest leverage



Be sure to use a lanyard that has more weight capacity than the tool you are attaching because drop forces are greater than actual tool weight.



TOOLS@HEIGHT™ DOUBLE HEAD FLARE NUT WRENCHES

Chrome Satin Finish, 6 Point, Metric



Product Code	Size (MM)	A	B	C	D	E	Weight (lbs)
		Overall Length (Inches)	Open End Dia (Inches)	Open End Thickness (Inches)	Open End Dia (Inches)	Open End Thickness (Inches)	
JHW10650-TH	9 x 11	5 11/16	13/16	11/32	15/16	5/16	0.11
JHW10652-TH	10 x 12	6 1/8	7/8	3/8	29/32	5/16	0.15
JHW10654-TH	13 x 14	6 7/8	1	3/8	1 3/32	3/8	0.20
JHW10656-TH	15 x 17	7 7/8	1 1/16	7/16	1 1/32	1/2	0.28
JHW10658-TH	19 x 21	8 7/8	1 9/32	1/2	1 13/32	17/32	0.43

Fed. Spec.: ANSI B107.9M

JHW11692-TH 5 Piece Double Head Flare Nut Wrench Set, 6 Point, Metric, in Pouch – 50001 1.43 lbs.

Contents Include:

Product Code	Size (MM)	Product Code	Size (MM)	Product Code	Size (MM)
JHW10650-TH	9 x 11	JHW10654-TH	13 x 14	JHW10658-TH	19 x 21
JHW10652-TH	10 x 12	JHW10656-TH	15 x 17		

Features

- Will not damage fittings on pipes and tubing
- Satin chrome textured finish provides great feel and extra gripping power
- Recessed corners in ends provide extra turning power



TOOLS@HEIGHT™ DOUBLE HEAD RATCHETING BOX WRENCHES

High Polish Chrome Finish, 6 & 12 Point, SAE



Product Code	Number of Points	Size (Inches)	A	B	C	D	E	Weight (lbs)
			Overall Length (Inches)	Box End Diameter (Inches)	Box End Thickness (Inches)	Box End Diameter (Inches)	Box End Thickness (Inches)	
JHWRB-810-TH	6	1/4 x 5/16	4 1/4	19/32	3/8	11/16	3/8	.12
JHWRB1214TH	6	3/8 x 7/16	5 1/2	25/32	3/8	7/8	3/8	.18
JHWRB1618TH	6	1/2 x 9/16	6 3/4	1	1/2	1 5/32	1/2	.33
JHWRB2022TH	12	5/8 x 11/16	8 1/8	1 5/16	1/2	1 7/16	1/2	.44
JHWRB2428TH	12	3/4 x 7/8	9 1/4	1 13/32	1/2	1 9/16	1/2	.48

Features

- Allows fast removal of fasteners with a ratcheting action at each end
- Ideal for long "bolt-through" applications
- Flat handle allows access to tight clearance areas



TOOLS@HEIGHT™ 30° SERVICE WRENCHES, SAE

Satin Chrome Finish, SAE



Product Code	Size (Inches)	Overall Length (Inches)	Head Diameter	Head Thickness	Weight (lbs.)
3524-TH	3/4	6 1/4	1 11/16	1/4	.31
3526-TH	13/16	6 1/4	1 11/16	1/4	.28
3528-TH	7/8	6 1/4	1 11/16	1/4	.28
3530-TH	15/16	6 7/8	1 7/8	1/4	.36
3532-TH	1	6 7/8	1 7/8	1/4	.37
3534-TH	1 1/16	6 7/8	1 7/8	1/4	.35
3536-TH	1 1/8	7	2 1/16	1/4	.37
3538-TH	1 3/16	7	2 1/16	1/4	.37
3540-TH	1 1/4	7	2 1/16	1/4	.36
3542-TH	1 5/16	7 3/8	2 1/2	9/32	.51
3544-TH	1 3/8	7 5/8	2 1/2	9/32	.49
3546-TH	1 7/16	7 5/8	2 1/2	9/32	.45
3548-TH	1 1/2	7 5/8	2 1/2	9/32	.48

Features

- Ultra thin pattern for use on jam nuts and access to confined areas
- 30° offset head
- Satin chrome finish



TOOLS AT HEIGHT
WRENCHES

BAHCO® TOOLS@HEIGHT™ ADJUSTABLE WRENCH F

Industrial Grade Steel Handles

Product Code	Length (Inches)	Maximum Jaw Opening (Inches)	Head Thickness (Inches)	Jaw Tip Thickness (Inches)	Weight (lbs.)
8070RCUS-TH	6	3/4	7/16	3/16	.30
8071RCUS-TH	8	1 1/16	1/2	1/4	.96
8072RCUS-TH	10	1 1/8	5/8	5/16	.96
8073RCUS-TH	12	1 5/16	11/16	7/16	1.47
8074RCUS-TH	15	1 11/16	13/16	9/16	2.44
8075RCUS-TH	18	2 1/16	7/8	11/16	3.85

Features

- Slim head with tapered jaws combine easy accessibility with extra turning strength
- Measurement scale on head conveniently shows fastener size
- Precision hardened and anti-corrosion treated.



TOOLS@HEIGHT™ ADJUSTABLE CONSTRUCTION WRENCH

Heavy-Duty With Polished Head and Measurement Scales

Product Code	Length (Inches)	Maximum Jaw Opening (Inches)	Head Thickness (Inches)	Weight (lbs)
JHW13625-TH	15	1 1/2	23/32	2.24

Features

- Tapered spud handle locates and aligns bolts and rivets
- Hole in handle permits tethering wrench for safety
- Measurement scale on head conveniently shows fastener size
- Economical black phosphate finish resists rust



TOOLS@HEIGHT™ SINGLE HEAD OPEN END OFFSET STRUCTURAL WRENCHES F

Industrial Black Finish, SAE

Product Code	Size (Inches)	A	B	C	D	Weight (lbs)
		Overall Length (Inches)	Open End Width (Inches)	Open End Thickness (Inches)	Handle Offset (Inches)	
JHW1905-TH	7/8	14 5/16	2	9/16	1	1.42
JHW1906-TH	15/16	14 3/16	1 3/32	19/32	1	1.51
JHW1907-TH	1 1/16	16 13/16	2 3/32	5/8	1 1/8	1.85
JHW1908-TH	1 1/4	17 11/16	2 23/32	11/16	1 1/4	2.85
JHW1909-TH	1 7/16	19 3/4	3 5/32	25/32	1 1/4	3.68
JHW1910-TH	1 5/8	21 1/16	3 7/32	7/8	1 1/2	4.26
JHW1911-TH	1 13/16	23	3 3/4	1 3/4	1 5/8	6.49
JHW1912-TH	2	23 3/4	4 7/32	31/32	1 5/8	7.02

Features

- Long offset handle is designed for clearance of obstructions while providing greater leverage
- Tapered spud handle locates and aligns bolt and rivet holes





TOOLS@HEIGHT™ ADJUSTABLE PIN SPANNER WRENCHES

Industrial Black Finish, SAE

Product Code	Span Diameter (Inches)	Pin Diameter (Inches)	Pin Length (Inches)	Overall Length (Inches)	Weight (lbs.)
JHWO-471-TH	3/4 to 2	1/8	1/8	5 3/8	.27
JHWO-472-TH	1 1/4 to 3	3/16	3/16	6 7/8	.48
JHWO-474-TH	2 to 4 3/4	1/4	1/4	9 1/2	.93
JHWO-474A-TH	4 1/2 to 6 1/4	3/8	1/4	9 7/8	1.10

Features

- Ideal for adjusting collars, lock nut rings, and bearings
- Specifically engineered to hold up under the most rigorous industrial use



JHWO-472-TH



JHWO-474-TH



TOOLS@HEIGHT™ ADJUSTABLE HOOK SPANNER WRENCHES

Industrial Black Finish, SAE

Product Code	Span Diameter (Inches)	Hook Depth (Inches)	Hook Thickness (Inches)	Overall Length (Inches)	Weight (lbs.)
JHW471-TH	3/4 to 2	1/8	11/32	5 3/8	.26
JHW472-TH	1 1/4 to 3	3/32	13/32	7 1/4	.49
JHW474-TH	2 to 4 3/4	3/16	15/32	11 1/2	.97
JHW474A-TH	4 1/2 to 6 1/4	1/4	15/32	17 1/2	1.05

Features

- Ideal for adjusting collars, lock nut rings, and bearings
- Specifically engineered to hold up under the most rigorous industrial use



JHW471-TH

TOOLS AT HEIGHT

WRENCHES



TOOLS@HEIGHT™ ADJUSTABLE FACE SPANNER WRENCHES

Industrial Black Finish, SAE

Product Code	Span Diameter (Inches)	Pin Diameter (Inches)	Pin Length (Inches)	Overall Length (Inches)	Weight (lbs.)
JHW482-TH	2	3/16	1/4	6 1/4	.31
JHW483-TH	3	1/4	1/4	8 1/8	.63
JHW484-TH	4	5/16	1/2	10 3/8	1.01

Features

- Ideal for adjusting collars, lock nut rings, and bearings
- Specifically engineered to hold up under the most rigorous industrial use



JHW483-TH



JHW484-TH



TOOLS@HEIGHT™ OFFSET PATTERN BOX END STRIKING WRENCHES

Industrial Black Finish, 12 Point, SAE / Metric

Product Code	Size (Inches)	Size (MM)	A			Weight (lbs)
			Overall Length (Inches)	Box End Diameter (Inches)	Box End Thickness (Inches)	
JHW8807W-TH	1 1/16	27	9 3/32	1 2/32	23/32	2.36
JHW8807AW-TH	1 1/8	-	10 3/32	1 15/16	3/4	2.71
JHW8808BW-TH	1 3/16	30	10 3/32	1 15/16	3/4	2.85
JHW8808W-TH	1 1/4	32	10 3/32	1 15/16	3/4	2.84
JHW8808AW-TH	1 5/16	33	10 3/32	1 15/16	3/4	2.7
JHW8808CW-TH	1 3/8	35	11 1/2	2 5/32	29/32	3.43
JHW8809W-TH	1 7/16	-	11 1/2	2 5/32	29/32	3.21
JHW8809BW-TH	-	36	11 1/2	2 5/32	29/32	3.46
JHW8809AW-TH	1 1/2	38	12	2 7/16	1	4.29
JHW8810W-TH	1 5/8	41	12	2 7/16	1	4.10
JHW8810AW-TH	1 11/16	43	12 5/16	2 11/16	1 1/8	5.22
JHW8811BW-TH	1 3/4	44	12 9/16	2 11/16	1 1/8	5.14
JHW8811W-TH	1 13/16	46	12 9/16	2 11/16	1 1/8	5.11
JHW8811AW-TH	1 7/8	-	13	2 7/8	1 1/4	5.18
JHW8812AW-TH	1 15/16	49	13	2 7/8	1 1/4	5.26
JHW8812BW-TH	-	50	13	2 7/8	1 1/4	5.40
JHW8812W-TH	2	51	13	2 7/8	1 1/4	5.53
JHW8813BW-TH	2 1/8	54	13 9/16	3 1/4	1 13/32	7.4
JHW8813W-TH	2 3/16	55	13 9/16	3 1/4	1 13/32	7.05
JHW8813AW-TH	2 1/4	57	13 9/16	3 1/4	1 13/32	7.41
JHW8814AW-TH	2 5/16	59	13 9/16	3 1/4	1 13/32	7.35
JHW8814W-TH	2 3/8	60	14 1/8	3 11/16	1 1/2	8.20
JHW8815BW-TH	2 1/2	64	14 1/8	3 11/16	1 1/2	8.07
JHW8815W-TH	2 9/16	65	14 1/8	3 11/16	1 1/2	7.82
JHW8815AW-TH	2 5/8	67	15	3 15/16	1 5/8	9.53
JHW8816W-TH	2 3/4	70	15	3 15/16	1 5/8	9.40
JHW8816CW-TH	2 7/8	73	16	4 7/16	1 3/4	12.50
JHW8816BW-TH	2 15/16	75	16	4 7/16	1 3/4	12.12
JHW8817AW-TH	3	76	16	4 7/16	1 3/4	12.34
JHW8817W-TH	3 1/8	80	16	4 7/16	1 3/4	11.62
JHW8818AW-TH	3 3/8	85	18 9/32	6	2	28.59
JHW8818W-TH	3 1/2	89	18 9/32	6	2	28.54
JHW8819BW-TH	3 3/4	95	18 9/32	6	2	27.86
JHW8819W-TH	3 7/8	98	18 9/32	6	2	27.34
JHW8819CW-TH	4 1/8	105	18 9/32	6	2	25.72
JHW8819AW-TH	4 1/4	108	18 9/32	6	2	26.82

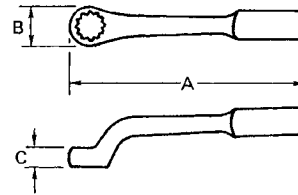

JHW8807W-TH

TOOLS AT HEIGHT

STRIKING WRENCHES

Features

- Striking face wrenches are designed to be struck by a hammer on the anvil area in order to loosen frozen fasteners or to set and tighten fasteners
- Anvils are proportional to opening sizes. Special heat treating provides maximum durability for long life
- Offset handle is close to head to provide clearance in confined areas
- Williams' expanded line of offset striking face wrenches, up to 4 1/4", provides the most extensive line on the market
- Specifically engineered to hold up under the most rigorous industrial use

JHW88SET-TH 36 Piece Set Offset Pattern Box End Striking Wrenches

Contents Include: One of each Offset Pattern Box End Striking Wrench

- Weight - 355 lbs.



Be sure to use a lanyard that has more weight capacity than the tool you are attaching because drop forces are greater than actual tool weight.

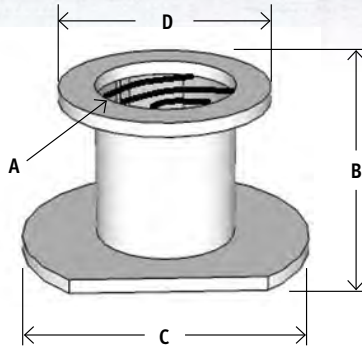

TOOLS@HEIGHT™ SLUGGING WRENCH RETAINERS

Product Code	Stud Size	Length	C	D
SWR-24	$\frac{3}{8}$	$1 \frac{29}{32}$	$1 \frac{15}{16}$	$1 \frac{3}{4}$
SWR-28	$\frac{7}{8}$	2	$2 \frac{3}{16}$	$1 \frac{29}{32}$
SWR-32	1	$2 \frac{1}{8}$	$2 \frac{1}{2}$	$2 \frac{1}{32}$
SWR-36	$1 \frac{1}{8}$	$2 \frac{1}{4}$	$2 \frac{1}{2}$	$2 \frac{5}{32}$
SWR-40	$1 \frac{1}{4}$	$2 \frac{3}{8}$	$2 \frac{7}{8}$	$2 \frac{9}{32}$
SWR-44	$1 \frac{3}{8}$	$2 \frac{15}{32}$	$3 \frac{1}{8}$	$2 \frac{3}{8}$
SWR-48	$1 \frac{1}{2}$	$2 \frac{5}{8}$	$3 \frac{1}{8}$	$2 \frac{1}{2}$
SWR-52	$1 \frac{5}{8}$	$2 \frac{3}{4}$	$3 \frac{5}{8}$	$2 \frac{21}{32}$
SWR-56	$1 \frac{3}{4}$	$2 \frac{7}{8}$	$3 \frac{7}{8}$	$2 \frac{3}{4}$
SWR-60	$1 \frac{7}{8}$	3	$4 \frac{1}{2}$	$2 \frac{7}{8}$

Features

- SWR-SET includes one of each retainer in a plastic box.
- Retainers feature attachment point to prevent drop during use.
- Slugging Wrench Retainers thread onto the end of the stud over the slugging wrench to ensure the wrench stays affixed to the fastener
- A spring loaded plate allows for easy adjustment of the wrench without having to unscrew the retainer.
- Increased productivity and safer operation by eliminating the need for a second worker to hold and slugging wrench in place
- Available in 10 sizes, marked with stud sizes (not hex sizes)
- Configured to work with offset and straight handle slugging wrenches



SWR-24



SWR-52



SWR-SET

TOOLS AT HEIGHT

WRENCH RETAINERS

TOOLS@HEIGHT™ FOLDING HEX KEY SETS



SAE and Metric

Product Code	JHWWS-45-TH		JHWWS-46-TH		JHWMWS-47-TH	
Number of Pieces	8		9		7	
	Hex Size (Inches)	Key Length (Inches)	Hex Size (Inches)	Key Length (Inches)	Includes Hex Size (MM)	Key Length (Inches)
	.050	1 1/4	5/64	1 1/2	1.5	1 3/8
	1/16	1 3/8	3/32	1 9/16	2	1 1/2
	5/64	1 7/16	7/64	1 11/16	2.5	1 5/8
	3/32	1 9/16	1/8	1 15/16	3	1 3/4
	7/64	1 5/8	9/64	2	4	2
	1/8	1 11/16	3/32	2 1/4	5	2 1/4
	9/64	1 13/16	2 1/2	2 5/8	6	2 1/2
	5/32	2	1/4	2 7/8		

Features

- Steel case is chrome plated to resist corrosion
- Keys are black oxide finish
- Convenient item for pocket or tool box
- Modified to prevent disassembly during use



JHWWS-45-TH

TOOLS@HEIGHT™ METAL HANDLE CLICK TYPE TORQUE WRENCHES - DUAL SCALE

Metal Handle Dual Scale. The metal handle series offers the user a rugged, industrial strength torque wrench able to withstand the rigors of professional use. Handles are lightly knurled for a tough, non-slip grip. There are 21 models of metal handle micrometer adjustable torque wrenches available.

Product Code	Drive Size	English Range	Incr.	Num Range	Incr.	A in.	B in.	C in.	D in.	Wt. Lbs.
2503MFRMH-TH	1/2"	30-250 ft. lb.	1	47-332 Nm	1.4	24.40	1.70	1.40	1.40	4.73
6004MFRMH-TH	3/4"	100-600 ft. lb.	5	169-779 Nm	6.8	42.00	2.50	2.00	1.15	7.85

Features

- Dual scale, calibrated dual direction
- Positive lock with spring loaded pull down lock ring
- Fast, accurate and easy to set
- Easy-to-read laser marked scales
- Accuracy: ± 3% CW ± 4% CCW of indicated value, CW, from 20% to 100% of full scale
- Individually serialized with matching certificate of calibration traceable to N.I.S.T.

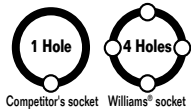

Competitor's socket Williams® socket

Williams® Tools@Height™ sockets, extensions, and adaptors feature a locking hole on all four sides, not just one. Williams® Tools@Height™ ratchets and drive tools feature a locking pin which mates with the side lock hole for positive retention. This reduces the risk of misaligning the socket that typical competitor's sockets with just one side hole create.



Release pin with THPRTA - Pin Release Tool for Williams® Square Drive Tools

Do not use quick release tools with locking collars or push button release. These tools can be disengaged inadvertently.



THPRTA

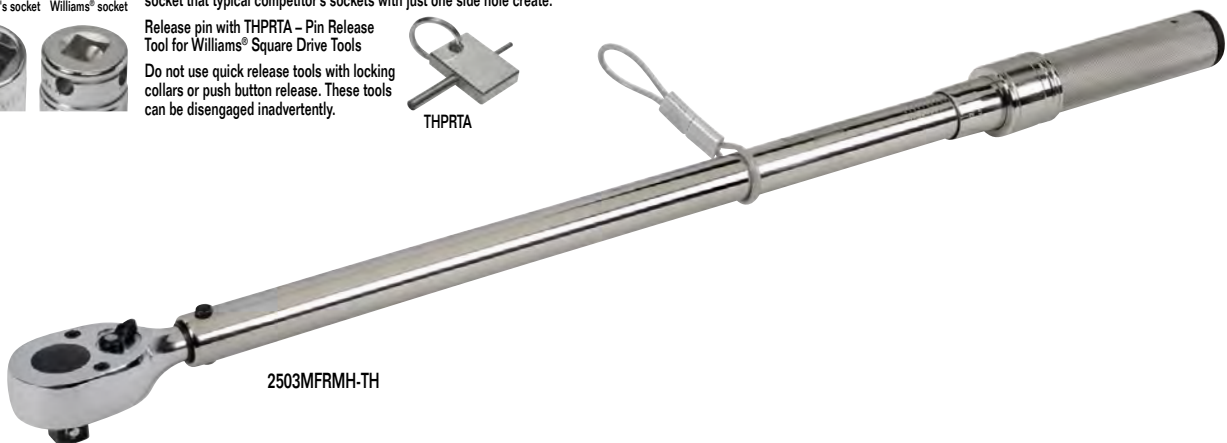

2503MFRMH-TH



Be sure to use a lanyard that has more weight capacity than the tool you are attaching because drop forces are greater than actual tool weight.



JHWM52EHATH



JHWMB52EHATH

TOOLS@HEIGHT™ 1/4" DRIVE ENCLOSED HEAD RATCHETS

Sealed Narrow Head Design, Chrome and Black Industrial Finish

Product Code	Description	Length (Inches)	Number of Teeth	Weight (lbs)
JHWM52EHATH	Chrome Finish Enclosed Head Ratchet	5 1/4	36	0.00
JHWMB52EHATH	Black Industrial Finish Enclosed Head Ratchet	5 1/4	36	0.21

Fed. Spec: ANSI B107.10M



Features

- Enclosed head is sealed to prevent dust, dirt, and liquids from entering head, preserving internal lubrication
- Forged one-piece ratchet provide strength and safety for industrial applications
- 36 tooth gear with 10 degree of engagement allows engagement in tight working areas
- Nickel/Chrome plating provides increase protection from rust and corrosion
- Chrome finish models feature mirror-like exterior that can be easily cleaned after each use
- Single Pawl ratchet design:
 - 1) Designed for tighter tolerances between pawl and gear which reduces metal fatigue and slippage under load
 - 2) Does not require as many working parts, reducing possible breakage and parts to repair
- Easy access reverse lever allows user to change working direction quickly and easily with only one hand

TOOLS@HEIGHT™ 1/4" DRIVE EXTENSIONS

High-Polished Chrome Finish

Product Code	Description	Length (Inches)	Weight (lbs.)
JHWM-102-TH	Extension	2	.06
JHWM-104-TH	Extension	4	.11
JHWM-115-TH	Extension	6	.15
JHWM-140A-TH	U-Joint	1 7/16	.11

Fed. Spec: ANSI B107.10M



Features

- Chrome plating provides increased protection from rust and corrosion
- Flexible extension is designed for low torque applications in limited access areas



JHWM-115-TH

TOOLS AT HEIGHT

RATCHETS/EXTENSIONS/SOCKETS



TOOLS@HEIGHT™ 1/4" DRIVE SHALLOW SOCKETS, 12 POINT, SAE

High-Polished Chrome Finish

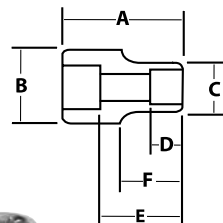

JHW30210-TH JHW30206-TH

Product Code	Size (Inches)	OAL (Inches)	Drive End Diameter (Inches)	Working End Diameter (Inches)	Broach Depth (Inches)	Bolt Clearance Depth (Inches)	Bolt Clearance Diameter (Inches)	Nose Length (Inches)	Weight (lbs)
JHW30206-TH	3/16	1	15/32	5/16	9/32	19/32	3/16	1/2	0.03
JHW30207-TH	7/32	1	15/32	11/32	5/16	19/32	7/32	1/2	0.03
JHW30208-TH	1/4	1	15/32	3/8	5/16	19/32	7/32	1/2	0.03
JHW30209-TH	9/32	1	15/32	7/16	5/16	19/32	1/4	1/2	0.03
JHW30210-TH	5/16	1	15/32	15/32	5/16	19/32	1/4	-	0.03
JHW30211-TH	11/32	1	1/2	1/2	5/16	19/32	11/32	-	0.04
JHW30212-TH	3/8	1	9/16	9/16	11/32	19/32	3/8	-	0.04
JHW30214-TH	7/16	1	5/8	5/8	7/16	19/32	7/16	-	0.05
JHW30216-TH	1/2	1	11/16	11/16	7/16	19/32	1/2	-	0.06
JHW30218-TH	9/16	1	3/4	3/4	7/16	19/32	17/32	-	0.07

Fed. Spec: ANSI B107.1

Features

- SUPERTORQUE® lobular openings for greater turning power without deforming the fastener
- Designed for maximum engagement on both 6 and 12 point fasteners

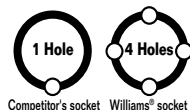

Competitor's socket Williams' socket

Williams® Tools@Height™ sockets, extensions, and adaptors feature a locking hole on all four sides, not just one. Williams® Tools@Height™ ratchets and drive tools feature a locking pin which mates with the side lock hole for positive retention. This reduces the risk of misaligning the socket that typical competitor's sockets with just one side hole create.



Release pin with THPRTA - Pin Release Tool for Williams® Square Drive Tools

Do not use quick release tools with locking collars or push button release. These tools can be disengaged inadvertently.



THPRTA



TOOLS@HEIGHT™ 1/4" DRIVE DEEP SOCKETS, 12 POINT, SAE

High-Polished Chrome Finish

Product Code	A		B		C		D		E		F	
	Size (Inches)	OAL (Inches)	Drive End Diameter (Inches)	Working End Diameter (Inches)	Broach Depth (Inches)	Bolt Clearance Depth (Inches)	Bolt Clearance Diameter (Inches)	Nose Length (Inches)	Weight (lbs)			
JHW30406-TH	3/16	1 31/32	15/32	5/16	5/16	1 5/16	1/8	1 1/32	0.04			
JHW30407-TH	7/32	1 31/32	15/32	11/32	3/8	1 5/16	3/16	15/16	0.05			
JHW30408-TH	1/4	1 31/32	15/32	7/16	13/16	1 11/32	7/32	1 1/32	0.05			
JHW30409-TH	9/32	1 31/32	15/32	7/16	25/32	1 11/32	1/4	31/32	0.05			
JHW30410-TH	5/16	1 31/32	15/32	15/32	13/16	1 5/16	9/32	-	0.05			
JHW30411-TH	11/32	1 31/32	1/2	1/2	23/32	1 5/16	9/32	-	0.07			
JHW30412-TH	3/8	1 31/32	9/16	9/16	7/8	1 11/32	5/16	-	0.09			
JHW30414-TH	7/16	1 31/32	5/8	5/8	7/8	1 1/2	13/32	-	0.10			
JHW30416-TH	1/2	1 31/32	11/16	11/16	27/32	1 17/32	7/16	-	0.11			
JHW30418-TH	9/16	1 31/32	3/4	3/4	29/32	1 9/16	17/32	-	0.14			

Fed. Spec: ANSI B107.1

Features

- SUPERTORQUE® lobular openings for greater turning power without deforming the fastener
- Designed for maximum engagement on 12 point fasteners

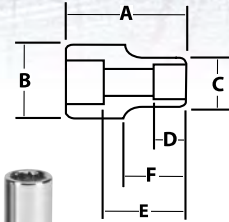

JHW30410-TH JHW30406-TH



TOOLS@HEIGHT™ 1/4" DRIVE STANDARD LENGTH HEX BIT SOCKETS, SAE

High-Polished Chrome Finish

Product Code	Size (Inches)	Socket Length (Inches)	Socket Outside Diameter (Inches)	Overall Length (Inches)	Bit Length (Inches)	Weight (lbs)
JHW35001-TH	3/32	13/16	15/32	1 13/32	5/8	0.04
JHW35002-TH	3/16	13/16	15/32	1 13/32	5/8	0.04
JHW35003-TH	7/32	13/16	15/32	1 13/32	5/8	0.04
JHW35004-TH	1/4	13/16	15/32	1 13/32	5/8	0.04
JHW35005-TH	5/16	13/16	15/32	1 13/32	5/8	0.04

JHW30902-TH 6 Piece Hex Bit Socket Set on Clip Rail .51 lbs

Contents Include:

Product Code	Size (Inches)	Product Code	Size (Inches)	Product Code	Size (Inches)
JHW35000-TH	1/8	JHW35002-TH	3/16	JHW35004-TH	1/4
JHW35001-TH	3/32	JHW35003-TH	7/32	JHW35005-TH	5/16

Features

- High-polished chrome finish socket cleans easily



JHW30902-TH

TOOLS AT HEIGHT

SOCKETS



TOOLS@HEIGHT™ 1/4" DRIVE STANDARD LENGTH HEX BIT SOCKETS, METRIC

High-Polished Chrome Finish

Product Code	Size (MM)	Socket Length (Inches)	Socket Outside Diameter (Inches)	Overall Length (Inches)	Bit Length (Inches)	Weight (lbs)
JHW35071-TH	4	13/16	15/32	1 13/32	5/8	0.04
JHW35072-TH	5	13/16	15/32	1 13/32	5/8	0.04
JHW35073-TH	6	13/16	15/32	1 13/32	5/8	0.04
JHW35074-TH	7	13/16	15/32	1 13/32	5/8	0.04
JHW35075-TH	8	13/16	15/32	1 13/32	5/8	0.04



JHW35072-TH

30904-TH 6 Piece Hex Bit Socket Set on Clip Rail .51 lbs

Contents Include:

Product Code	Size (MM)	Product Code	Size (MM)	Product Code	Size (MM)
JHW35070-TH	3	JHW35072-TH	5	JHW35074-TH	7
JHW35071-TH	4	JHW35073-TH	6	JHW35075-TH	8

Features

- High-polished chrome finish socket cleans easily

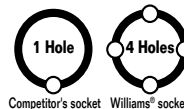

Williams® Tools@Height™ sockets, extensions, and adaptors feature a locking hole on all four sides, not just one. Williams® Tools@Height™ ratchets and drive tools feature a locking pin which mates with the side lock hole for positive retention. This reduces the risk of misaligning the socket that typical competitor's sockets with just one side hole create.



Release pin with THPRTA - Pin Release Tool for Williams® Square Drive Tools

Do not use quick release tools with locking collars or push button release. These tools can be disengaged inadvertently.



THPRTA



Be sure to use a lanyard that has more weight capacity than the tool you are attaching because drop forces are greater than actual tool weight.



TOOLS@HEIGHT™ 3/8" DRIVE ENCLOSED HEAD RATCHETS

Williams® Sealed Narrow Head Design, Chrome and Black Industrial Finish

Product Code	Description	Length (Inches)	Number of Teeth	Weight (lbs)
JHWB52EHATH	Black Industrial Finish Enclosed Head Ratchet	8	36	.76
JHWB52EHATH	Chrome Finish Enclosed Head Ratchet	8	36	.76
JHWB52EHLATH	Chrome Finish Enclosed Head Ratchet, Long	10 1/4	36	.87

Fed. Spec: ANSI B107.10M



Features

- Enclosed head is sealed to prevent dust, dirt, and liquids from entering head preserving internal lubrication
- Forged one-piece ratchet provide strength and safety for industrial applications
- Smooth comfort-grip handle permits all-day use without gloves
- 36 tooth gear with 10 degree of engagement allows engagement in tight working areas
- Nickel/Chrome plating provides increase protection from rust and corrosion
- Chrome finish models feature mirror-like exterior that can be easily cleaned after each use
- Single Pawl ratchet design:
 - 1) Designed for tighter tolerances between pawl and gear which reduces metal fatigue and slippage under load
 - 2) Does not require as many working parts, reducing possible breakage and parts to repair
- Easy access reverse lever allows user to change working direction quickly and easily with only one hand

TOOLS@HEIGHT™ 3/8" DRIVE EXTENSIONS AND ACCESSORIES

High-Polished Chrome Finish

Product Code	Description	Length (Inches)	Weight (lbs)
JHWB-108-TH	Extension	3	.19
JHWB-110-TH	Extension	6	.34
JHWB-115-TH	Extension	11	.61
JHWB-118-TH	Extension	18	.93
JHWB-140A-TH	Universal Joint	2	.15
JHWB-70-TH	Ratchet Spinner Disk	1 1/4	.14

Fed. Spec: ANSI B107.10M



Features

- Chrome plating provides increased protection from rust and corrosion
- Flexible extension is designed for low torque applications in limited access areas
- Spinner disk is ideal for fast turn down of fasteners

TOOLS@HEIGHT™ 3/8" DRIVE HANDLE

Knurled Handle, High-Polished Chrome Finish

Product Code	Description	Length (Inches)	Weight (lbs)
JHWB-40A-TH	Flex Handle	8 9/16	.67

Fed. Spec: ANSI B107.10M



Features

- Chrome plating provides increased protection from rust and corrosion
- Drive handles provide extra leverage with greater strength than ratchets

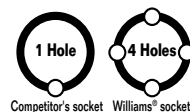

Competitor's socket Williams' socket

Williams® Tools@Height™ sockets, extensions, and adaptors feature a locking hole on all four sides, not just one. Williams® Tools@Height™ ratchets and drive tools feature a locking pin which mates with the side lock hole for positive retention. This reduces the risk of misaligning the socket that typical competitor's sockets with just one side hole create.



Release pin with THPRTA – Pin Release Tool for Williams® Square Drive Tools

Do not use quick release tools with locking collars or push button release. These tools can be disengaged inadvertently.



THPRTA



TOOLS@HEIGHT™ 3/8" DRIVE SHALLOW SOCKETS, 12 POINT, SAE

High-Polished Chrome Finish

Product Code	Size (Inches)	A		B		C		D		E		F		Weight (lbs.)
		OAL (Inches)	Drive End Diameter (Inches)	Working End Diameter (Inches)	Broach Depth (Inches)	Bolt Clearance Depth (Inches)	Bolt Clearance Diameter (Inches)	Nose Length (Inches)						
JHW31208-TH	1/4	1	1 1/16	7/16	11/32	9/16	7/32	17/32	0.04					
JHW31210-TH	3/16	1	1 1/16	15/32	3/8	17/32	1/4	17/32	0.05					
JHW31212-TH	3/8	1	1 1/16	9/16	3/8	1/2	9/32	17/32	0.05					
JHW31214-TH	7/16	1	1 1/16	5/8	11/32	17/32	13/32	17/32	0.05					
JHW31216-TH	1/2	1	3/4	3/4	13/32	19/32	7/16	-	0.07					
JHW31218-TH	9/16	1 1/16	25/32	25/32	17/32	5/8	17/32	-	0.08					
JHW31220-TH	5/8	1 1/16	7/8	7/8	19/32	11/16	19/32	-	0.09					
JHW31222-TH	11/16	1 1/16	15/16	15/16	1/2	11/16	21/32	-	0.11					
JHW31224-TH	3/4	1 1/8	1	1	9/16	23/32	23/32	-	0.15					
JHW31226-TH	13/16	1 1/8	1 1/8	1 1/8	9/16	23/32	25/32	-	0.17					
JHW31228-TH	7/8	1 1/2	1 3/16	1 3/16	21/32	13/16	27/32	-	0.21					
JHW31230-TH	15/16	1 7/8	1 1/4	1 1/4	21/32	13/16	27/32	-	0.23					
JHW31232-TH	1	1 7/8	1 3/16	1 5/16	11/16	13/16	31/32	-	0.26					

Fed. Spec: ANSI B107.1

Features

- SUPERTORQUE® lobular openings for greater turning power without deforming the fastener
- Designed for maximum engagement on 12 point fasteners

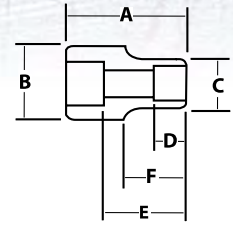

JHW31216-TH

JHW31208-TH



TOOLS@HEIGHT™ 3/8" DRIVE DEEP SOCKETS, 12 POINT, SAE

High-Polished Chrome Finish

Product Code	Size (Inches)	A		B		C		D		E		F		Weight (lbs.)
		OAL (Inches)	Drive End Diameter (Inches)	Working End Diameter (Inches)	Broach Depth (Inches)	Bolt Clearance Depth (Inches)	Bolt Clearance Diameter (Inches)	Nose Length (Inches)						
JHW31408-TH	1/4	2 1/2	1 1/16	7/16	11/32	1 11/16	7/32	1 1/16	0.11					
JHW31410-TH	3/16	2 1/2	1 1/16	15/32	3/8	1 11/16	5/16	1 1/16	0.11					
JHW31412-TH	3/8	2 1/2	1 1/16	9/16	3/8	1 11/16	3/8	1 1/16	0.12					
JHW31414-TH	7/16	2 1/2	1 1/16	5/8	11/32	1 11/16	7/16	1 1/16	0.12					
JHW31416-TH	1/2	2 1/2	3/4	3/4	13/32	1 11/32	19/32	-	0.15					
JHW31418-TH	9/16	2 1/2	25/32	25/32	17/32	1 9/16	17/32	-	0.18					
JHW31420-TH	5/8	2 1/2	7/8	7/8	19/32	1 9/16	19/32	-	0.21					
JHW31422-TH	11/16	2 1/2	15/16	15/16	1/2	1 11/16	21/32	-	0.25					
JHW31424-TH	3/4	2 1/2	1	1	9/16	1 11/16	23/32	-	0.27					
JHW31426-TH	13/16	2 1/2	1 1/8	1 1/8	9/16	2 1/32	25/32	-	0.34					
JHW31428-TH	7/8	2 1/2	1 3/16	1 3/16	21/32	2 1/32	27/32	-	0.38					
JHW31430-TH	15/16	2 1/2	1 1/4	1 1/4	21/32	2 1/32	27/32	-	0.44					
JHW31432-TH	1	2 1/2	1 5/16	1 5/16	11/16	2	31/32	-	0.49					

Fed. Spec: ANSI B107.1

Features

- SUPERTORQUE® lobular openings for greater turning power without deforming the fastener
- Designed for quick engagement on both 6 and 12 point fasteners

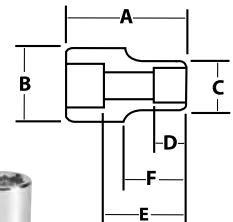

JHW31416-TH JHW31408-TH

TOOLS AT HEIGHT

SOCKETS

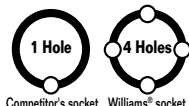

Competitor's socket Williams' socket

Williams® Tools@Height™ sockets, extensions, and adaptors feature a locking hole on all four sides, not just one. Williams® Tools@Height™ ratchets and drive tools feature a locking pin which mates with the side lock hole for positive retention. This reduces the risk of misaligning the socket that typical competitor's sockets with just one side hole create.

Release pin with THPRTA – Pin Release Tool for Williams® Square Drive Tools

Do not use quick release tools with locking collars or push button release. These tools can be disengaged inadvertently.



THPRTA





JHW35100-TH

TOOLS@HEIGHT™ 3/8" DRIVE STANDARD LENGTH HEX BIT SOCKETS, SAE F

High-Polished Chrome Finish

Product Code	Size (Inches)	Socket Length (Inches)	Socket Outside Diameter (Inches)	Overall Length (Inches)	Bit Length (Inches)	Weight (lbs.)
JHW35100-TH	1/8	1 3/16	3/4	1 27/32	2 1/32	0.09
JHW35101-TH	9/64	1 3/16	3/4	1 27/32	2 1/32	0.09
JHW35102-TH	5/32	1 3/16	3/4	1 27/32	2 1/32	0.10
JHW35103-TH	3/16	1 3/16	3/4	1 27/32	2 1/32	0.09
JHW35104-TH	7/32	1 3/16	3/4	1 27/32	2 1/32	0.10
JHW35105-TH	1/4	1 3/16	3/4	1 27/32	2 1/32	0.09
JHW35106-TH	5/16	1 3/16	3/4	1 31/32	13/16	0.11
JHW35107-TH	3/8	1 3/16	3/4	1 31/32	13/16	0.12

Features

- High-polished chrome finish socket cleans easily.

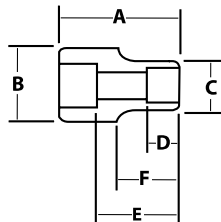

JHW31154-TH



JHW31142-TH



TOOLS@HEIGHT™ 3/8" DRIVE UNIVERSAL SOCKETS, 6 POINT, SAE

High-Polished Chrome Finish

Product Code	Size (Inches)	OAL (Inches)	Drive End Diameter (Inches)	Open End Diameter (Inches)	Broach Depth (Inches)	Bolt		Nose Length (Inches)	Weight (lbs.)
						Clearance Depth (Inches)	Clearance Diameter (Inches)		
JHW31142-TH	3/8	1 53/64	3/4	9/16	3/8	35/64	2 1/64	5/16	0.11
JHW31144-TH	7/16	1 53/64	3/4	5/8	3/8	35/64	2 1/64	5/16	0.11
JHW31146-TH	1/2	1 57/64	3/4	45/64	13/32	37/64	2 1/64	13/32	0.12
JHW31148-TH	9/16	1 57/64	3/4	25/32	7/16	43/64	2 1/64	33/64	0.13
JHW31150-TH	5/8	2	3/4	55/64	7/16	45/64	2 1/64	33/64	0.14
JHW31152-TH	1 1/16	2 3/64	3/4	15/16	3/4	3/4	2 1/64	17/32	0.15
JHW31154-TH	3/4	2 3/64	3/4	1 1/64	1/2	51/64	2 1/64	17/32	0.16

Fed. Spec: ANSI B107.1

Features

- Ideal for work in confined areas where fastener is inaccessible to standard sockets

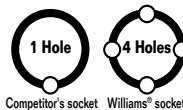

Competitor's socket

Williams' socket

Williams® Tools@Height™ sockets, extensions, and adaptors feature a locking hole on all four sides, not just one. Williams® Tools@Height™ ratchets and drive tools feature a locking pin which mates with the side lock hole for positive retention. This reduces the risk of misaligning the socket that typical competitor's sockets with just one side hole create.



Release pin with THPRTA – Pin Release Tool for Williams® Square Drive Tools

Do not use quick release tools with locking collars or push button release. These tools can be disengaged inadvertently.



THPRTA

TOOLS@HEIGHT™ 1/2" DRIVE SCAFFOLDING RATCHET

Product Code	Description	Product Code	Description
BS-63A	Scaffolding Ratchet with reversed pry bar	JHWBS-63BRK	Repair Kit
JHWBS-62	Scaffolding Ratchet with out pry bar	JHWBS-63BTIP	Hammer Tip
JHWBS-63B	Scaffolding Ratchet with pry bar	JHWBS-63BBAR	Pry Bar

Features

- 1/2" Drive with pinned 7/8" 6-point socket, 2-1/4" length
- 36 tooth gear with 10 degree of engagement allows engagement in tight working areas
- Bronze hammer head reduces rebound
- Pry bar handle provide alignment option
- Socket feature SUPERTORQUE lobular opening for greater turning power without deforming the fastener
- Easy access reversing lever allows user to change working direction quickly and easily with only one hand
- Tethering device attached to handle



TOOLS@HEIGHT™ 1/2" DRIVE ENCLOSED HEAD RATCHETS

Williams® Sealed Narrow Head Design, Chrome and Black Industrial Finish

Product Code	Description	Length (Inches)	Number of Teeth	Weight (lbs)
JHWS52EHATH	Chrome Finish Enclosed Head Ratchet	10 1/4	36	1.61
JHWS52EHLATH	Chrome Finish Enclosed Head Ratchet, Long	15	36	1.94
JHWBS52EHATH	Black Industrial Finish Enclosed Head Ratchet	10 1/4	36	1.61

Fed. Spec: ANSI B107.10M



Features

- Enclosed head is sealed to prevent dust, dirt, and liquids from entering head, preserving internal lubrication
- Forged one-piece ratchet provide strength and safety for industrial applications
- Smooth comfort-grip handle permits all-day use without gloves
- 36 tooth gear with 10 degree of engagement allows engagement in tight working areas
- Nickel/Chrome plating provides increase protection from rust and corrosion
- Chrome finish models feature mirror-like exterior that can be easily cleaned after each use

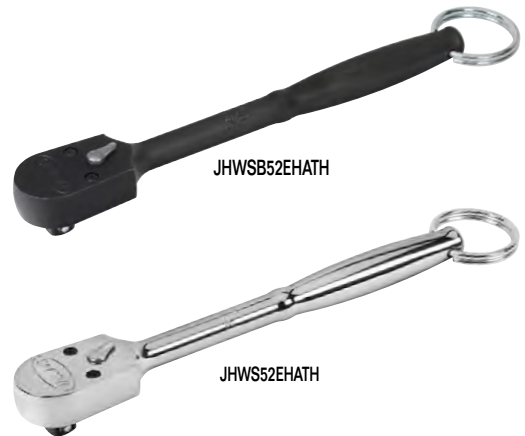

TOOLS@HEIGHT™ 1/2" DRIVE HANDLES

Knurled Handle, Chrome and Black Industrial Finish

Product Code	Description	Length (Inches)	Weight (lbs)
JHWS-40AA-TH	Chrome Flex Handle	10 13/16	1.34
JHWS-41AA-TH	Chrome Flex Handle	15 1/2	2.07
JHWBS41AATH	Black Industrial Finish Flex Handle	15 1/2	2.06

Fed. Spec: ANSI B107.10M



Features

- Chrome plating provides increased protection from rust and corrosion.
- Drive handles provide extra leverage with greater strength than ratchets.
- Speeder handle is ideal for fast turn down of fasteners.



TOOLS AT HEIGHT

RATCHETS/HANDLES/EXTENSIONS

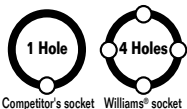

Competitor's socket Williams® socket

Williams® Tools@Height™ sockets, extensions, and adaptors feature a locking hole on all four sides, not just one. Williams® Tools@Height™ ratchets and drive tools feature a locking pin which mates with the side lock hole for positive retention. This reduces the risk of misaligning the socket that typical competitor's sockets with just one side hole create.



Release pin with THPRTA - Pin Release Tool for Williams® Square Drive Tools
Do not use quick release tools with locking collars or push button release. These tools can be disengaged inadvertently.



THPRTA



JHWS-140A-TH

TOOLS@HEIGHT™ 1/2" DRIVE EXTENSIONS AND ACCESSORIES

High-Polished Chrome Finish

Product Code	Description	Length (Inches)	Weight (lbs.)
JHWS-102P-TH	Extension	2	.38
JHWS-110P-TH	Extension	5	.50
JHWS-115P-TH	Extension	10	.93
JHWS-121P-TH	Extension	20	1.76
JHWS-140A-TH	Universal Joint	2 1/16	.29

Fed. Spec: ANSI B107.10M

Features

- Chrome plating provides increased protection from rust and corrosion



JHWS-121P-TH



TOOLS@HEIGHT™ 1/2" DRIVE SHALLOW 12 POINT SOCKETS, SAE

High-Polished Chrome Finish

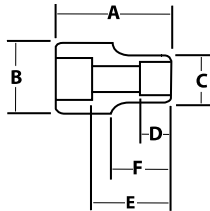

JHW32220-TH

JHW32212-TH

Product Code	Size (Inches)	A		B		C		D		E		F	
		OAL (Inches)	Drive End Diameter (Inches)	Working End Diameter (Inches)	Broach Depth (Inches)	Bolt Clearance Depth (Inches)	Bolt Clearance Diameter (Inches)	Nose Length (Inches)	Weight (lbs.)				
JHW32212-TH	3/8	1 1/2	7/8	5/8	1/2	25/32	9/16	23/32	0.11				
JHW32214-TH	7/16	1 1/2	7/8	11/16	1/2	27/32	13/32	11/16	0.12				
JHW32216-TH	1/2	1 1/2	7/8	3/4	17/32	27/32	19/32	23/32	0.12				
JHW32218-TH	9/16	1 1/2	7/8	19/16	17/32	27/32	17/32	11/16	0.12				
JHW32220-TH	5/8	1 1/2	29/32	29/32	17/32	27/32	9/16	-	0.14				
JHW32222-TH	11/16	1 1/2	31/32	31/32	9/16	27/32	21/32	-	0.16				
JHW32224-TH	3/4	1 1/2	1	1	3/4	29/32	23/32	-	0.19				
JHW32226-TH	13/16	1 1/2	1 1/8	1 1/8	25/32	31/32	29/32	-	0.21				
JHW32228-TH	7/8	1 5/8	1 3/16	1 3/16	7/8	1 1/32	7/8	-	0.25				
JHW32230-TH	15/16	1 5/8	1 1/4	1 1/4	7/8	1 5/32	29/32	-	0.29				
JHW32232-TH	1	1 5/8	1 5/16	1 5/16	7/8	1 3/16	31/32	-	0.32				
JHW32234-TH	1 1/16	1 3/4	1 7/16	1 7/16	31/32	1 9/32	1 1/16	-	0.40				
JHW32236-TH	1 1/8	1 3/4	1 1/2	1 1/2	31/32	1 5/16	1 5/32	-	0.44				
JHW32238-TH	1 3/16	1 3/4	1 9/16	1 9/16	31/32	1 5/16	1 1/4	-	0.50				
JHW32240-TH	1 1/4	1 3/4	1 11/16	1 21/32	31/32	1 5/16	1 1/4	-	0.55				
32242-TH	1 9/16	1 47/64	1 1/2	1 47/64	59/64	59/64	1 3/16	-	0.56				
32244-TH	1 3/8	1 47/64	1 37/64	1 53/64	59/64	59/64	1 17/64	-	0.64				
32246-TH	1 7/16	1 31/32	1 21/32	1 57/64	1 1/16	1 1/16	1 11/32	-	0.66				
JHW32248-TH	1 1/2	1 31/32	1 11/16	1 31/32	1 1/8	1 1/2	1 1/8	-	0.72				

Fed. Spec: ANSI B107.1

Features

- SUPERTORQUE® lobular openings for greater turning power without deforming the fastener
- Designed for quick engagement on both 6 and 12 point fasteners

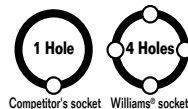

Competitor's socket Williams® socket



Williams® Tools@Height™ sockets, extensions, and adaptors feature a locking hole on all four sides, not just one. Williams® Tools@Height™ ratchets and drive tools feature a locking pin which mates with the side lock hole for positive retention. This reduces the risk of misaligning the socket that typical competitor's sockets with just one side hole create.

Release pin with THPRTA - Pin Release Tool for Williams® Square Drive Tools

Do not use quick release tools with locking collars or push button release. These tools can be disengaged inadvertently.



THPRTA

TOOLS AT HEIGHT

SOCKETS



TOOLS@HEIGHT™ 1/2" DRIVE DEEP SOCKETS, 12 POINT, SAE

High-Polished Chrome Finish

Product Code	Size (Inches)	A		B		C		D		E		F		Weight (lbs.)
		OAL (Inches)	Drive End Diameter (Inches)	Working End Diameter (Inches)	Broach Depth (Inches)	Bolt Clearance Depth (Inches)	Bolt Clearance Diameter (Inches)	Nose Length (Inches)						
JHW32412-TH	3/8	3	7/8	5/8	1	2 7/32	1 1/32	1 15/32	0.23					
JHW32414-TH	7/16	3 1/2	7/8	11/16	1 1/8	2 9/32	1 15/32	0.24						
JHW32416-TH	1/2	3 1/2	7/8	3/4	3 1/2	2 7/32	7/16	1 15/32	0.24					
JHW32418-TH	9/16	3 1/2	7/8	13/16	1 3/2	2 7/32	1/2	1 15/32	0.26					
JHW32420-TH	5/8	3 1/2	29/32	29/32	1 3/16	2 3/16	9/16	-	0.27					
JHW32422-TH	11/16	3 1/2	15/16	15/16	1 3/8	2 3/16	21/32	-	0.27					
JHW32424-TH	3/4	3 1/2	1 1/16	1 1/16	1 1/4	2 11/32	23/32	-	0.27					
JHW32426-TH	13/16	3 1/2	1 1/8	1 1/8	1 15/32	2 3/16	3/4	-	0.41					
JHW32428-TH	7/8	3 1/2	1 3/16	1 3/16	1 13/32	2 1/4	27/32	-	0.45					
JHW32430-TH	15/16	3 1/2	1 1/4	1 1/4	1 13/32	2 3/32	29/32	-	0.50					
JHW32432-TH	1	3 1/2	1 11/32	1 11/32	1 13/32	2 5/32	15/16	-	0.58					
JHW32434-TH	1 1/16	3 1/2	1 13/32	1 13/32	1 3/8	2 11/32	1 1/32	-	0.64					
JHW32436-TH	1 1/8	3 1/2	1 1/2	1 1/2	1 7/16	2 3/8	1 1/16	-	0.75					
JHW32438-TH	1 3/16	3 1/2	1 9/16	1 9/16	1 7/16	2 3/16	1 1/16	-	0.81					
JHW32440-TH	1 1/4	3 1/2	1 21/32	1 21/32	1 7/16	2 1/16	1 1/16	-	0.88					
32442-TH	1 5/16	3 1/2	1 47/64	1 47/64	1 3/8	2 11/64	1 3/16	-	0.98					
32444-TH	1 3/8	3 1/2	1 53/64	1 53/64	1 3/8	2 11/64	1 1/64	-	1.12					
32446-TH	1 7/16	3 1/2	1 57/64	1 57/64	1 3/8	2 11/64	1 1/32	-	1.19					
JHW32448-TH	1 1/2	3 1/2	1 15/16	1 1/2	1 7/16	2 3/16	1 1/16	-	1.38					

Fed. Spec: ANSI B107.1

Features

- SUPERTORQUE® lobular openings for greater turning power without deforming the fastener
- Designed for quick engagement on both 6 and 12 point fasteners

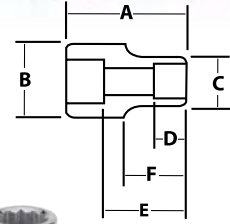

JHW32420-TH JHW32412-TH

TOOLS AT HEIGHT

SOCKETS



TOOLS@HEIGHT™ 1/2" DRIVE SHALLOW SOCKETS, 8 POINT, SAE

High-Polished Chrome Finish

Product Code	Size (Inches)	A		B		C		D		E		F		Weight (lbs.)
		OAL (Inches)	Drive End Diameter (Inches)	Working End Diameter (Inches)	Broach Depth (Inches)	Bolt Clearance Depth (Inches)	Bolt Clearance Diameter (Inches)	Nose Length (Inches)						
JHWST-812-TH	3/8	1 1/2	7/8	29/32	5/16	27/32	5/16	7/8	0.14					
JHWST-814-TH	7/16	1 1/2	7/8	13/16	3/8	27/32	5/16	7/8	0.13					
JHWST-816-TH	1/2	1 1/2	29/32	29/32	13/32	27/32	11/32	-	0.16					
JHWST-818-TH	9/16	1 1/2	31/32	31/32	7/16	27/32	7/16	-	0.18					
JHWST-820-TH	5/8	1 1/2	1 1/16	1 1/16	1/2	27/32	7/16	-	0.24					
JHWST-822-TH	11/16	1 1/2	1 3/16	1 3/16	1/2	27/32	17/32	-	0.37					
JHWST-824-TH	3/4	1 1/2	1 9/32	1 9/32	9/16	13/16	23/32	-	0.37					
JHWST-826-TH	13/16	1 5/8	1 7/16	17/16	9/16	31/32	27/32	-	0.49					
JHWST-828-TH	7/8	1 3/4	1 1/2	1 1/2	5/8	1 1/16	15/16	-	0.53					
JHWST-830-TH	15/16	1 13/16	1 5/8	1 5/8	11/16	1 1/8	1 1/32	-	0.63					
JHWST-832-TH	1	1 15/16	1 11/16	1 11/16	1 1/16	1 1/4	1 1/32	-	0.78					

Fed. Spec: ANSI B107.1

Features

- SUPERTORQUE® lobular openings for greater turning power without deforming the fastener
- 8 point sockets are designed for quick engagement on 4 point fasteners

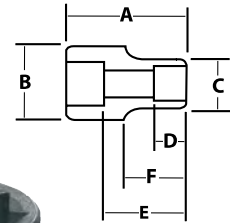

JHWST-812-TH

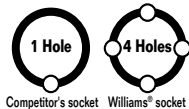

Competitor's socket Williams' socket

Williams® Tools@Height™ sockets, extensions, and adaptors feature a locking hole on all four sides, not just one. Williams® Tools@Height™ ratchets and drive tools feature a locking pin which mates with the side lock hole for positive retention. This reduces the risk of misaligning the socket that typical competitor's sockets with just one side hole create.

Release pin with THPRTA - Pin Release Tool for Williams® Square Drive Tools

Do not use quick release tools with locking collars or push button release. These tools can be disengaged inadvertently.



THPRTA



Be sure to use a lanyard that has more weight capacity than the tool you are attaching because drop forces are greater than actual tool weight.



TOOLS@HEIGHT™ 1/2" DRIVE DEEP SOCKETS, 12 POINT, METRIC

High-Polished Chrome Finish

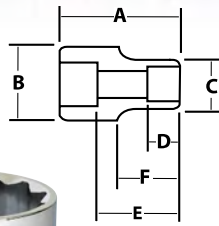

JHW32820-TH

Product Code	Size (MM)	A OAL (Inches)	B Drive End Diameter (Inches)	C Working End Diameter (Inches)	D Broach Depth (Inches)	E Bolt Clearance Depth (Inches)	F Bolt Clearance Diameter (Inches)	Nose Length (Inches)	Weight (lbs)
JHW32809-TH	9	3 1/4	29/32	19/32	5/16	2 15/32	1 1/32	2 19/32	0.22
JHW32810-TH	10	3 1/4	29/32	19/32	5/16	2 15/32	1 1/32	2 19/32	0.22
JHW32811-TH	11	3 1/4	29/32	1 1/16	5/16	2 15/32	1 3/32	2 19/32	0.22
JHW32812-TH	12	3 1/4	29/32	23/32	13/32	2 15/32	7/16	2 19/32	0.23
JHW32813-TH	13	3 1/4	29/32	25/32	3/8	2 15/32	15/32	2 19/32	0.24
JHW32814-TH	14	3 1/4	29/32	27/32	3/8	2 15/32	15/32	2 19/32	0.24
JHW32815-TH	15	3 1/4	29/32	7/8	3/8	2 1 1/32	15/32	-	0.24
JHW32816-TH	16	3 1/4	29/32	29/32	9/16	2 1 1/32	15/32	-	0.27
JHW32817-TH	17	3 1/4	31/32	31/32	9/16	2 1 1/32	15/32	-	0.31
JHW32818-TH	18	3 1/4	1	1	13/16	2 1 1/32	15/32	-	0.34
JHW32819-TH	19	3 1/4	1 1/32	1 1/32	13/16	2 5/16	23/32	-	0.37
JHW32820-TH	20	3 1/4	1 1/16	1 1/16	13/16	2 5/16	23/32	-	0.40
JHW32821-TH	21	3 1/4	1 1/8	1 1/8	13/16	2 5/16	3/4	-	0.41
JHW32822-TH	22	3 1/4	1 3/16	1 3/16	13/16	2 5/16	25/32	-	0.46
JHW32823-TH	23	3 1/4	1 1/4	1 1/4	25/32	2 5/16	27/32	-	0.49
JHW32824-TH	24	3 1/4	1 9/32	1 9/32	13/16	2 5/16	7/8	-	0.52
JHW32825-TH	25	3 1/4	1 5/16	1 5/16	13/16	2 1/4	15/16	-	0.55
JHW32826-TH	26	3 1/4	1 3/8	1 3/8	29/32	2 1/4	31/32	-	0.57
JHW32827-TH	27	3 1/4	1 7/16	1 7/16	31/32	2 1/4	1	-	0.66
JHW32828-TH	28	3 1/4	1 1/2	1 1/2	1	2 1/4	1 1/32	-	0.73
JHW32829-TH	29	3 1/4	1 9/16	1 9/16	1 1/32	2 1/4	1 1/16	-	0.78
JHW32830-TH	30	3 1/4	1 5/8	1 5/8	1 1/32	2 1/4	1 3/32	-	0.83
JHW32832-TH	32	3 1/4	1 11/16	1 11/16	1 1/8	2 1/4	1 3/16	-	0.93
32834-TH	34	3 1/4	1 3/4	1 3/4	7/8	2 1/4	1	-	0.93
JHW32836-TH	36	3 1/4	1 15/16	1 15/16	7/8	2 1/4	1 13/32	-	1.16

Fed. Spec: ANSI B107.5

JHW32949-TH - 24 Piece 1/2" Drive Deep 12 Point Socket Set on Clip Rail 12.02 lbs.

Features

- SUPERTORQUE® lobular openings for greater turning power without deforming the fastener
- Designed for quick engagement on both 6 and 12 point fasteners



JHW35212-TH



JHW35274-TH

TOOLS@HEIGHT™ 1/2" DRIVE STANDARD LENGTH HEX BIT SOCKETS, SAE



High-Polished Chrome Finish

Product Code	Size (Inches)	Socket Length (Inches)	Socket Outside Diameter (Inches)	Overall Length (Inches)	Bit Length (Inches)	Weight (lbs)
JHW35208-TH	1/4	1 1/16	29/32	2 13/32	27/32	0.17
JHW35210-TH	5/16	1 7/16	29/32	2 13/32	27/32	0.17
JHW35212-TH	3/8	1 7/16	29/32	2 13/32	27/32	0.19
JHW35214-TH	7/16	1 7/16	29/32	2 13/32	27/32	0.22
JHW35202-TH	1/2	1 19/32	7/8	2 13/32	27/32	0.26
JHW35203-TH	9/16	1 19/32	1	2 13/32	27/32	0.33
JHW35204-TH	5/8	1 19/32	1 1/16	2 13/32	27/32	0.39
JHW35206-TH	3/4	1 19/32	1 3/16	2 13/32	27/32	0.51

TOOLS@HEIGHT™ 1/2" DRIVE STANDARD LENGTH HEX BIT SOCKETS, METRIC



High-Polished Chrome Finish

Product Code	Size (MM)	Socket Length (Inches)	Socket Outside Diameter (Inches)	Overall Length (Inches)	Bit Length (Inches)	Weight (lbs)
JHW35274-TH	8	1 19/32	29/32	2 13/32	27/32	0.17
JHW35275-TH	10	1 19/32	29/32	2 7/16	27/32	0.19
JHW35276-TH	12	1 19/32	29/32	2 7/16	27/32	0.22
JHW35277-TH	14	1 19/32	1	2 7/16	27/32	0.32
JHW35278-TH	17	1 19/32	1 3/32	2 7/16	27/32	0.43
JHW35279-TH	19	1 19/32	1 3/16	2 7/16	27/32	0.51

Features

- High-polished chrome finish socket cleans easily



Williams® Tools@Height™ sockets, extensions, and adaptors feature a locking hole on all four sides, not just one. Williams® Tools@Height™ ratchets and drive tools feature a locking pin which mates with the side lock hole for positive retention. This reduces the risk of misaligning the socket that typical competitor's sockets with just one side hole create.

Release pin with THPRTA - Pin Release Tool for Williams® Square Drive Tools

Do not use quick release tools with locking collars or push button release. These tools can be disengaged inadvertently.



THPRTA

TOOLS@HEIGHT™ 3/4" DRIVE INTEGRATED HANDLE RATCHETS

Chrome and Black Industrial Finish

Product Code	Description	Length (Inches)	Number of Teeth	Weight (lbs)
JHWH-51B-TH	Chrome Finish Ratchet	20 1/8	24	6.04
JHWHB-51B-TH	Black Industrial Finish Ratchet	20 1/8	24	6.04

Fed. Spec: ANSI B107.10M

Features

- Forged one-piece ratchet provide strength and safety for industrial applications
- Smooth comfort-grip handle permits all-day use without gloves



JHWH-51B-TH

JHWHB-51B-TH

TOOLS@HEIGHT™ 3/4" DRIVE EXTENSIONS

Chrome and Black Industrial Finish

Product Code	Description	Length (Inches)	Weight (lbs)
JHWH-104B-TH	Black Industrial Finish Drive Extension	3	0.73
JHWH-110B-TH	Black Industrial Finish Drive Extension	8	1.70
JHWH-110-TH	Chrome Finish Drive Extension	8	1.72
JHWH-115-TH	Chrome Finish Drive Extension	16	3.25

Fed. Spec: ANSI B107.10M

Features

- Chrome plating provides increased protection from rust and corrosion



JHWH-110-TH

JHWH-104B-TH

TOOLS AT HEIGHT

RATCHETS/EXTENSIONS/HANDLES

TOOLS@HEIGHT™ 3/4" DRIVE HANDLE

Chrome and Black Industrial Finish

Product Code	Description	Length (Inches)	Finish
JHWH-41AA-TH	Flex Handle Breaker Bar, Knurled Grip	22 1/8	Chrome

Fed. Spec: ANSI B107.10M

Features

- Chrome plating provides increased protection from rust and corrosion
- Drive handles provide extra leverage with greater strength than ratchets
- Square drive slides on T-Handles for versatility
- Flex handle flex drive swivels 110° in either direction



JHWH-41AA-TH

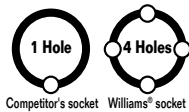

Competitor's socket Williams® socket

Williams® Tools@Height™ sockets, extensions, and adaptors feature a locking hole on all four sides, not just one. Williams® Tools@Height™ ratchets and drive tools feature a locking pin which mates with the side lock hole for positive retention. This reduces the risk of misaligning the socket that typical competitor's sockets with just one side hole create.



Release pin with THPRTA – Pin Release Tool for Williams® Square Drive Sockets

Do not use quick release tools with locking collars or push button release. These tools can be disengaged inadvertently.



THPRTA



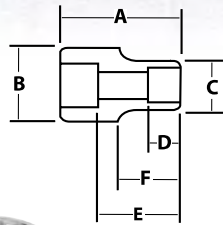

JHW33244-TH

JHW33228-TH

TOOLS@HEIGHT™ 3/4" DRIVE SHALLOW 12 POINT SOCKETS, SAE



High-Polished Chrome Finish

Product Code	Size (Inches)	OAL (Inches)	Drive End Diameter (Inches)	Working End Diameter (Inches)	Nose Length (Inches)	Weight (lbs)
JHW33228-TH	7/8	1 15/16	1 7/16	1 1/4	35/64	0.46
JHW33230-TH	15/16	2	1 7/16	1 3/8	5/8	0.49
JHW33232-TH	1	2 1/16	1 7/16	1 7/16	5/8	0.49
JHW33234-TH	1 1/16	2 1/16	1 7/16	1 1/2	7/8	0.49
JHW33236-TH	1 1/8	2 1/8	1 1/2	1 5/8	7/8	0.54
JHW33238-TH	1 3/16	2 1/8	1 1/2	1 11/16	15/16	0.60
JHW33240-TH	1 1/4	2 3/8	1 1/2	1 3/4	15/16	0.64
JHW33242-TH	1 9/16	2 3/8	1 1/2	1 13/16	1	0.69
JHW33244-TH	1 3/8	2 1/4	1 5/8	1 7/8	1	0.83
JHW33246-TH	1 7/16	2 1/4	1 5/8	1 31/32	1 7/64	0.90
JHW33248-TH	1 1/2	2 3/8	1 3/4	2 1/16	1 7/64	1.01
JHW33252-TH	1 5/8	2 1/2	1 3/4	2 3/16	1 3/16	1.17
JHW33256-TH	1 3/4	2 5/8	1 13/16	2 5/16	1 1/4	1.37
JHW33258-TH	1 13/16	2 11/16	1 13/16	2 3/8	1 1/4	1.37
JHW33260-TH	1 7/8	2 3/4	1 7/8	2 1/2	1 11/32	1.57
JHW33264-TH	2	2 13/16	1 7/8	2 11/16	1 13/32	1.64

Fed. Spec: ANSI B107.1

TOOLS@HEIGHT™ 1" DRIVE HANDLE

Chrome and Black Industrial Finish

Product Code	Description	Length (Inches)	Finish	Weight (lbs)
JHWX-41C-TH	Flex Handle Breaker Bar, Knurled Grip	34 3/16	Chrome	10.93

Fed. Spec: ANSI B107.10M



Features

- Chrome plating provides increased protection from rust and corrosion
- Drive handles provide extra leverage with greater strength than ratchets
- Square drive slides on T-Handles for versatility
- Flex handle flex drive swivels 110° in either direction
- Spring and plunger socket retention



JHWX-41C-TH

TOOLS@HEIGHT™ 1" DRIVE RATCHET

Integrated Handle, Chrome Finish

Product Code	Description	Length (Inches)	Number of Teeth	Weight (lbs)
JHWX-51B-TH	Chrome Ratchet	20 1/8	24	6.25

Fed. Spec: ANSI B107.10M



Features

- Forged one-piece ratchet provide strength and safety for industrial applications
- Smooth comfort-grip handle permits all-day use without gloves
- 24 tooth gear with 15 degree of engagement allows engagement in tight working areas
- Chrome finish with mirror-like exterior can be easily cleaned after each use

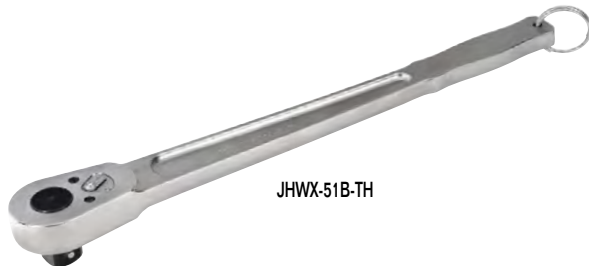

JHWX-51B-TH

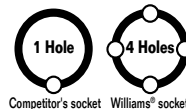

Competitor's socket Williams' socket

Williams® Tools@Height™ sockets, extensions, and adaptors feature a locking hole on all four sides, not just one. Williams® Tools@Height™ ratchets and drive tools feature a locking pin which mates with the side lock hole for positive retention. This reduces the risk of misaligning the socket that typical competitor's sockets with just one side hole create.



Release pin with THPRTA - Pin Release Tool for Williams® Square Drive Tools

Do not use quick release tools with locking collars or push button release. These tools can be disengaged inadvertently.



THPRTA

TOOLS AT HEIGHT

HANDLES/RATCHETS

TOOLS@HEIGHT™ 1000V ERGO® SCREWDRIVERS



Three Component Handle with Black Oxide Tips

Product Code	Overall Length (Inches)	Blade Length (Inches)	Tip Width (Inches)	Weight (lbs)
SLOTTED				
BE-8220S-TH	9	4	1/8	.089
BE-8040S-TH	8 3/4	4	5/32	.136
BE-8050S-TH	8 3/4	4	7/32	.089
PHILLIPS				
BE-8610S-TH	8	3 5/32	1	.141
BE-8620S-TH	8 3/4	4	2	.241

Features

- The three component ergonomically designed handle provides comfort and maximum grip even with oily hands
- For use with optional WTHUNIRET1 retractable lanyard



TOOLS@HEIGHT™ 5 PIECE PREMIUM MIXED SCREWDRIVER SET

Premium Comfort Grip Handles and Blades

Product Code	Description
100P-5MD-TH	5 Piece Premium Screwdriver Set Phillips/Slotted

Contents Include:

Product Code	Overall length (Inches)	Blade Length (Inches)	Tip Width/Point Size
JHWSDR-22-TH	6 1/8	3	3/16
JHWSDR-24-TH	7 7/8	4	1/4
JHWSDR-26-TH	10 11/16	6	5/16
JHWSDP13TH	6 1/4	3	#1 Phillips
JHWSDP24TH	7 15/16	4	#2 Phillips



100P-5MD-TH

TOOLS@HEIGHT™ SLOTTED SCREWDRIVERS



Premium Comfort Grip Handles and Blades

Product Code	Overall Length (Inches)	Blade Length (Inches)	Tip Width (Inches)	Weight (lbs)
JHWSDS-62-TH	3 7/8	1 1/2	3/16	0.09
JHWSDR-22-TH	6 1/8	3	3/16	0.17
JHWSDR-24-TH	7 7/8	4	1/4	0.26
JHWSDR-26-TH	10 11/16	6	5/16	0.38
JHWSDR-28-TH	12 11/16	8	3/8	0.59
JHWSDR-30-TH	14 3/4	10	7/16	0.66

Features

- Comfort-grip handle with thumb stop allow for added turning power without discomfort or slippage.
- Hi-polish chrome blades prevent corrosion and can be easily cleaned.
- Vapor-blasted tips grip fasteners and prevent chipping, extending tool life.
- Blades are made from special alloy steel for extra strength.



JHWSDS-62-TH

JHWSDR-24-TH



Rotating screwdriver tabs – tab is located for secure retention and allow full use of the screwdriver handle

- Stainless steel tab is corrosion resistant
- Tab rotates freely 360° so the lanyard does not wrap around the users hand
- Nylon bushing has a shoulder so the tab will not bind between the handle and shank bolster



Be sure to use a lanyard that has more weight capacity than the tool you are attaching because drop forces are greater than actual tool weight.

JHWSDP2STTH



JHWSDP24TH

TOOLS@HEIGHT™ PHILLIPS® SCREWDRIVERS W/ROUND BLADES

Premium Comfort Grip Handles and Blades

Product Code	Overall Length (Inches)	Blade Length (Inches)	Point Size	Weight (lbs)
JHWSDP2STTH	3 7/8	1 1/2	2	0.10
JHWSDP13TH	6 1/4	3	1	0.15
JHWSDP24TH	7 15/16	4	2	0.25
JHWSDP28TH*	12	8	2	0.30
JHWSDP36TH	10 1/2	6	3	0.39
JHWSDP46TH	10 3/4	6	4	0.53

* Does not have Bolster



Features

- Comfort-grip handle with thumb stop allow for added turning power without discomfort or slippage
- Hi-polish chrome blades prevent corrosion and can be easily cleaned
- Vapor-blasted tips grip fasteners and prevent chipping, extending tool life
- Blades are made from special alloy steel for extra strength.

TOOLS@HEIGHT™ WEDGE WIDTH POSITION ADJUSTABLE SHACKLE

Durable Shackle with Wave Washers

Product Code	Overall Length Wedge Only (Inches)	Overall Length Including Shackle (Inches)	Overall Width Including Shackle (Inches)	Width Wedge Working Area (Inches)	Tip Thickness (Inches)	Weight (lbs)
JHWWG6412TH	12	14	2.3	2	0.1	6.9
JHWWG2408TH	8	9	1.82	1.5	0.1	1.5
THCARA257FTB	SST Carabiner to carabiner bungee lanyard, medium duty					

Features

- Wedge features a durable shackle with wave washers that allow the shackle to be positioned out of the way while being struck Precision machined socket end
- Useful for most separating and positioning tasks
- Designed to allow the shackle to swivel fully from one side to the other
- Made from heat treated alloy steel; Stainless steel shackle is durable and will not corrode in harsh environments
- Shackle has position adjustment feature to keep the shackle out of the hammer path, even when used upside down
- Shackle pin is locked in place to prevent it from "walking out" during use

TOOLS@HEIGHT™ BULL PINS WIDTH POSITION ADJUSTABLE SHACKLE

Durable Shackle with Wave Washers

Product Code	Overall Length Bull Pin Only (Inches)	Overall Length Including Shackle (Inches)	Overall Width Including Shackle (Inches)	Diameter Bull Pin Working Area (Inches)	Point Diameter (Inches)	Weight (lbs)
JHWP4014TH	14	16	2 5/16	1 1/4	5/16	3.5
JHWP3410TH	10	11	1 13/16	1 1/16	1/4	3
THCARA257FTB	SST Carabiner to carabiner bungee lanyard, medium duty					
KLE5417T	Bull Pin Holder - Leather					

Features

- Bull Pins feature a durable shackle with wave washers that allow the shackle to be positioned out of the way while being struck
- Broad head bull pin for most alignment tasks
- Head of bull pin designed to allow the shackle to swivel fully from one side to the other
- Bull Pin made from heat treated alloy steel; Stainless steel shackle is durable and will not corrode in harsh environments
- Shackle has position adjustment feature to keep the shackle out of the hammer path, even when used upside down
- Shackle pin is locked in place to prevent it from "walking out" during use
- Broad head angle allows shackle to pass from side to side, even as head mushrooms from being struck

JHWWG6412TH



JHWP4014TH



TOOLS@HEIGHT™ UTILITY SUPERJOINT PLIERS

Double-Dipped Plastic Handles

Features	Overall Length (Inches)	Maximum Opening (Inches)	Tip Width (Inches)	Weight (lbs)
JHWPL1519CTH	5	1/2	3/16	0.22
JHWPL1520CTH	10	1 1/2	5/16	0.92
JHWPL1523CTH	12	2 5/8	1/2	1.50
JHWPL1524CTH	16	4	1/2	2.78

Features

- Multiple parallel jaw positions are locked in to proper groove for superior non-slip performance
- Serrated jaws for maximum gripping power
- Polished heads resist rust and corrosion, extending the tool life



JHWPL1520CTH

TOOLS@HEIGHT™ COMBINATION SLIP-JOINT PLIERS

Double-Dipped Plastic Handles

Product Code	Overall Length (Inches)	Jaw Length (Inches)	Tip Width (Inches)	Weight (lbs)
JHWPL-8C-TH	8	1 13/32	3/8	0.73
JHWPL-10C-TH	10	1 13/32	1/2	1.04

Features

- Multiple parallel jaw positions are locked in to proper groove for superior non-slip performance
- Serrated jaws for maximum gripping power
- Polished heads resist rust and corrosion, extending the tool life
- Shear type wire cutter extends tool use



JHWPL-10C-TH

TOOLS@HEIGHT™ INDUSTRIAL GRADE LINESMAN'S PLIERS

Double-Dipped Plastic Handles

Product Code	Description	Overall Length (Inches)	Jaw Length (Inches)	Weight (lbs)
JHWPL204CTH	Electrician's	7	1/2	.62

Features

- Designed for wiring, electrical equipment installation and maintenance for utility linemen
- Polished faces look good and resist corrosion
- Induction hardened cutting edges stay sharp longer
- Diamond serrated jaws provide solid grip on wire
- Double-dipped plastic handle grips are comfortable yet durable



JHWPL204CTH



JHWPL-57C-TH

TOOLS@HEIGHT™ HIGH LEVERAGE DIAGONAL CUTTING PLIERS

Double-Dipped Plastic Handles

Product Code	Description	Overall Length (Inches)	Cutting Blade Length (Inches)	Weight (lbs)
JHWPL-57C-TH	High Leverage Head	7 1/4	15/16	0.50

Features

- Handles are designed to cut wire with ease
- Polished heads resist rust and corrosion, extending the tool life
- Induction hardened cutting edges



JHWPL-46C-TH

TOOLS@HEIGHT™ INDUSTRIAL GRADE DIAGONAL CUTTING PLIERS

Double-Dipped Plastic Handles

Product Code	Overall Length (Inches)	Cutting Blade Length (Inches)	Weight (lbs)
JHWPL-46C-TH	6	3/4	.37
JHWPL-47C-TH	7	11/16	.50

Features

- Handles are designed to cut wire with ease
- Polished heads resist rust and corrosion, extending the tool life
- Induction hardened cutting edges
- Regular flush cutters are used for cutting hard wire

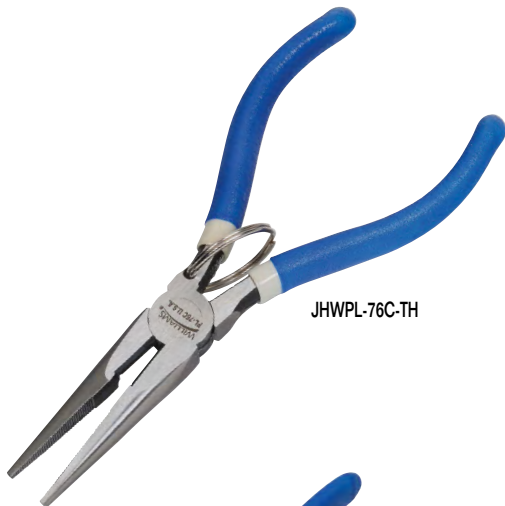

JHWPL-76C-TH

TOOLS@HEIGHT™ CHAIN NOSE PLIERS

Double-Dipped Plastic Handles

Product Code	Description	Overall Length (Inches)	Jaw Length (Inches)	Weight (lbs)
JHWPL-76C-TH	Long Nose w/cutter	6 1/2	1 5/16	.38

Features

- Polished heads resist rust and corrosion, extending the tool life
- Diamond serrated jaws with industrial hardened cutting edges



JHWPL149CTH

TOOLS@HEIGHT™ DUCK BILL PLIERS

Double-Dipped Plastic Handles

Product Code	Description	Overall Length (Inches)	Jaw Length (Inches)	Weight (lbs)
JHWPL149CTH	High Leverage	8	1 1/4	.44

Features

- Jaws are polished with rust-protective coating
- Flat wide nose provides a better grip than the regular needle nose models



TOOLS@HEIGHT™ THIN BENT CHAIN NOSE PLIERS

Double-Dipped Plastic Handles

Product Code	Description	Overall Length (Inches)	Jaw Length (Inches)	Weight (lbs)
JHWPL126CTH	73° Bent Thin Nose	6 1/4	1 1/4	0.33

Features

- Polished heads resist rust and corrosion, extending the tool life
- Serrated jaws for extra gripping power
- 73° bent nose model featured thin jaws angled to reach around obstacles and hard-to-reach spaces



JHWPL126CTH

TOOLS@HEIGHT™ HEAVY DUTY FRONT END WIRE STRIPPERS

Double-Dipped Plastic Handles

Product Code	Overall Length (Inches)	Capacity (AWG-solid wire)	Capacity (stranded wire)	Weight (lbs)
JHW23506-TH	6 1/4	10-20	12-20	.24

Features

- Double-dipped handles with air cushion pockets provide comfortable grip, reducing hand fatigue
- Spring-loaded handles speed work and reduce hand effort
- Serrated gripping jaws in nose for use as pliers
- 2-piece hardened steel pivot for long life service
- Lock protects cutting edges in storage



JHW23506-TH

TOOLS@HEIGHT™ MULTI-PURPOSE COMBINATION WIRE TOOLS

Double-Dipped Plastic Handles with Curved Wire Cutter

Product Code	Description	Overall Length (Inches)	Nose Style	Weight (lbs)
JHW23503-TH	Front-end Stripper	8 1/4	Serrated Pliers	0.45

Features

- Crimp and strip wire sizes 10-22 AWG
- Double-dipped handles with air cushion pockets provide comfortable grip, reducing hand fatigue
- 23503 cuts 6 bolt sizes: 4-40 / 5-40 / 6-32 / 8-32 / 10-32 / 10-24



JHW23503-TH

TOOLS@HEIGHT™ WIRE TWISTER / CUTTER

Produces Right Hand (clockwise) Twists

Product Code	Overall Length (Inches)	Jaw Length (Inches)	Cutting Blade Length (Inches)	Weight (lbs)
JHWWTC-11-TH	8.5	1 1/16	1/4	.53

Features

- Diamond-shaped, flat top jaw serrations hold wire firmly and resist nicking material being worked on
- Diagonal nose configurations & "mini" frame allows access in tight quarters
- Automatic return feature retracts automatically, speeding up operation use and reducing operator fatigue
- Heat-treated cutting edge holds its edge for cutting tough (up to .041) stainless steel and safety wire
- One hand operation allows for operator closing and locking with minimum of handle force
- High carbon alloy steel forging are used for maximum durability and long life



JHWWTC-11-TH



JHW23303A-TH

TOOLS@HEIGHT™ CABLE CUTTER FOR FERROUS MATERIALS

Locking Pliers

Product Code	Overall Length (Inches)	Weight (lbs)
JHW23302A-TH	7	0.71
JHW23303A-TH	10	1.15

Features

- Convenient one-hand release lever
- Heavy-duty jaw surfaces provide extra gripping power

JHW23310A-TH



JHW23321A-TH

TOOLS@HEIGHT™ LOCKING PLIERS

Long Nose with Wire Cutter Locking Pliers

Product Code	Overall Length (Inches)	Weight (lbs)
JHW23310A-TH	9	0.80

Locking C-Clamps

Product Code	Overall Length (Inches)	Throat Depth	Capacity (Lbs.)	Weight (lbs)
JHW23321A-TH	11	2 1/4"	900	1.65

Features

- Convenient one-hand release lever
- Heavy-duty jaw surfaces provide extra gripping power



JHWCC404CTH

TOOLS@HEIGHT™ DROP FORGED C-CLAMPS

Deep Throat Design, Copper Plated Screw

Product Code	Capacity (Inches)	Throat Depth (Inches)	Screw Diameter (Inches)	Min Test Load (lbs)	Weight (lbs)
JHWCC402CTH	2	2 11/32	1/2	3500	1.50
JHWCC404CTH	4	3 3/16	3/4	6500	3.15
JHWCC406CTH	6	4 1/8	3/4	6900	5.24
JHWCC408CTH	8	5 3/16	3/4	6900	7.5

Features

- Copper plated screw resists weld splatter
- Drop-forged and heat treated for maximum strength and greater rigidity
- I-Beam design for extra strength
- Highly resistant to "springing"



TOOLS@HEIGHT™ PIPE WRENCHES

Aluminum, Heavy Duty

Product Code	Overall Capacity (Inches)	Maximum jaw Opening	Weight (lbs)
R31090-TH	10	1 1/2	1
R47057-TH	12	2	2.5
R31095-TH	14	2	2.5
R31100-TH	18	2 1/2	3.75
R31105-TH*	24	3	6.5
R31110-TH*	36	5	11.2
R31115-TH*	48	6	19.5

Features

- Professional strength in lightweight aluminum
- Offers the durability and ease-of-use



*Tools@Height Tools Over 5 lbs. with Engineered Attachment Point. Three-foot-long web strap/carabiner system designed for use with "master ring" systems.



R31090-TH

We pin the tang of the removable pipe wrench jaw so it cannot become separated from the handle

TOOLS@HEIGHT™ PIPE WRENCHES

Cast Iron, Heavy Duty

Product Code	Overall Capacity (Inches)	Maximum jaw Opening	Weight (lbs)
R31000-TH	6	3/4	0.5
R31005-TH	8	1	0.75
R31010-TH	10	1 1/2	1.75
R31015-TH	12	2	2.75
R31020-TH	14	2	3.5
R31025-TH*	18	2 9/16	5.8
R31030-TH*	24	3	9.5
R31035-TH*	36	5	19.5
R31040-TH*	48	6	32

Features

- Sturdy, cast-iron housing and I-beam handle with full floating forged hook jaw, featuring self-cleaning threads with replaceable hook and heel jaws
- Heavy-duty pipe wrenches comply with federal specifications GGG-W65IE, Type II, Class A



*Tools@Height Tools Over 5 lbs. with Engineered Attachment Point. Three-foot-long web strap/carabiner system designed for use with "master ring" systems.



R31010-TH

R31030-TH

Tools@Height Tools Over 5 lbs. with Engineered Attachment Point. Three-foot-long web strap/carabiner system designed for use with "master ring" systems.

TOOLS@HEIGHT™ PIPE CHAIN WRENCH

Heat Treated

Product Code	Pipe Diameter Minimum -		Handle Length (Inches)	Chain Length (Inches)	Weight (lbs)
	Maximum (Pipe Size)				
JHWCW-4-TH	3/8	4	11	15	1.80

Features

- Forged handle is fully heat-treated
- Ideal for use in close quarters and where space is at a premium
- Successive "bites" can be taken without removal of wrench from the work piece
- Fully adjustable to fit any shape pipe



JHWCW-4-TH



THFSNE3-22SM

TOOLS@HEIGHT™ CLAW HAMMER

Solid steel hammer with Cushion Grip

Product Code	Head Weight (ozs.)	Handle Length (Inches)	Overall Length (Inches)	Weight (lbs.)
THFSNE3-22SM	22	7 1/4	15 3/4	2.13
MOIE3-16C-TH	16	11	13	1.5

Features

- Cushion grip handle provides greater comfort and safety
- Durable design for a long lasting hammer



JHW20543-TH

TOOLS@HEIGHT™ BALL PEIN HAMMERS

Fiberglass Handles with Cushion Grip

Product Code	Handle Length (Inches)	Overall Length (Inches)	Face Diameter (Inches)	Weight (lbs.)
JHW20542-TH	9 1/2	10 3/4	7/8	1.84
JHW20543-TH	10 1/4	11 3/4	7/8	1.23
JHW20544-TH	11 1/4	13	1 7/8	1.67
JHW20545-TH	13	15	1 1/4	2.31
JHW20546-TH	12 3/4	15	1 1/4	2.69

Features

- Ideal for driving punches, chisels and other metal work
- Fiberglass handle has a cushion grip for greater comfort and safety
- Hammer heads are drop-forged from specially selected steel and carefully heat treated for dependable strength, hardness and uniformity



HSB-1.5A-TH

TOOLS@HEIGHT™ BRONZE HAMMER

Fiberglass Handles with Cushion Grip

Product Code	Handle Length (Inches)	Overall Length (Inches)	Face Diameter (Inches)	Weight Class (lbs)
HSB-1.5A-TH	10 3/4	12	1	1.91

Features

- Ideal for applications which require non-sparking conditions
- The flat surface brass head absorbs impact blows, reduces rebound and helps eliminate marred work surfaces
- Non-slip cushion grip provides greater comfort and safety



TOOLS@HEIGHT™ DRILLING HAMMER

Fiberglass Handles with Cushion Grip

Product Code	Handle Length (Inches)	Overall Length (Inches)	Weight (lbs.)
JHW20678-TH	8 ½	10 ¼	2.55

Features

- Handles are durable and comfortable
- Heavy duty construction for strength and durability



JHW20678-TH

TOOLS@HEIGHT™ CROSS PEIN HAMMER

Fiberglass Handles with Cushion Grip

Product Code	Weight (ozs.)	Handle Length (Inches)	Overall Length (Inches)	Weight (lbs.)
20651-TH	48	13	15 ¾	4.96

Features

- Handles are durable and comfortable
- Heavy duty construction for strength and durability



20651-TH



SHF-10LA-TH

TOOLS@HEIGHT™ SLEDGE HAMMERS

Fiberglass Handles

Product Code	Weight Class (lbs.)	Handle Length (Inches)	Overall Length (Inches)	Face Diameter (Inches)	Weight (lbs.)
SHF-4SA-TH **	4	14	14	1 ¼	4.93
SHF-8SA-TH **	8	32	32	2	10.34
SHF-12SA-TH **	12	32	32	2 ¼	14.45
SHF-4A-TH	4	14	14	1 ½	4.78
SHF-6A-TH	6	32	32	1 ¾	7.74
SHF-8A-TH	8	32	32	2	9.89
SHF-10A-TH	10	16	16	2 ½	11.34
SHF-10LA-TH	10	32	32	2 ½	12.18
SHF-12A-TH	12	32	32	2 ¼	14.70
SHF-16A-TH	16	24	24	2 ½	18.43

Features

- ** Soft steel safety head is similar in hardness to brass
- ** Ideal replacement for Brass Head where non-sparking is not required
- Double faced head is hardened and tempered forged for maximum strength and durability





C-807-TH

TOOLS@HEIGHT™ PRY BARS - SCREWDRIVER TYPE

Comfort Grip Handles

Product Code	Size	Overall Length (inches)	Weight (lbs)
C-807-TH	3/8	12	0.67
C-812-TH	3/8	17	0.86
C-818-TH	1/2	25	1.9491

Features

- Blade is heat-treated the entire length
- Handle is ergonomically designed to provide a more comfortable and secure grip
- Curved blade style gives extra leverage
- Capped end allows for striking without damage to hand.



JHWP-17-TH

TOOLS@HEIGHT™ 17 PIECE PUNCH & CHISEL SET

Packed in a Roll Pouch

Product Code	Description	Weight (lbs)
JHWP-17-TH	17 Piece Punch & Chisel Set	4.93

Contents Include:

Product Code	Description	Point Diameter (Inches)	Product Code	Description	Blade Width (Inches)
JHWP-4-TH	Pin Punch	1/8	C-10-TH	Cold Chisel	5/16
JHWP-6-TH	Pin Punch	3/16	C-12-TH	Cold Chisel	3/8
JHWP-8-TH	Pin Punch	1/4	C-16-TH	Cold Chisel	1/2
JHWP-14-TH	Solid Punch	1/8	C-20-TH	Cold Chisel	5/8
JHWP-15-TH	Solid Punch	5/32	C-24-TH	Cold Chisel	3/4
JHWP-16-TH	Solid Punch	3/16	C-42-TH	Cape Chisel	1/4
JHWP-25-TH	Long Taper Punch	5/32	C-62-TH	Diamond Point Chisel	3/8
JHWP-28-TH	Long Taper Punch	1/4			
JHWP-32-TH	Prick Punch	-			
JHWP-40-TH	Center Punch	-			

Features

- Heavy duty construction for strength and durability.



TOOLS AT HEIGHT

PRY BARS/PUNCH & CHISEL SET

TOOLS@HEIGHT™ COLD CHISELS

Heavy Duty Industrial Grade

Product Code	Stock Size	Blade Width (Inches)	Length (Inches)	Weight (lbs)
JHWC-10-TH	1/4	5/16	5	0.07
JHWC-12-TH	5/16	3/8	5 1/2	0.13
JHWC-15-TH	3/8	7/16	6	0.20
JHWC-16-TH	7/16	1/2	6	0.26
JHWC-20-TH	1/2	5/8	6 1/2	0.33
JHWC-24-TH	5/8	3/4	7	0.59
JHWC-32-TH	7/8	1	8	1.28

Features

- The most commonly used chisels in the chisel line
- For cutting, shaping and removing metal softer than the cutting edge of the chisel



TOOLS@HEIGHT™ CAPE CHISELS

Heavy Duty Industrial Grade

Product Code	Stock Size	Blade Width (Inches)	Length (Inches)	Weight (lbs)
JHWC-42-TH	3/8	1/4	5	0.15

Features

- Designed for cutting or grooving keyholes or slots



TOOLS@HEIGHT™ DIAMOND POINT CHISELS

Heavy Duty Industrial Grade

Product Code	Stock Size	Square Cut	Length (Inches)	Weight (lbs)
JHWC-62-TH	5/8	3/8	7	.56

Features

- Designed for making a V-groove in metal and to clean out inside corners





JHWP-4-TH



JHWP-16-TH



JHWP-32-TH



JHWP-40-TH

TOOLS@HEIGHT™ PIN PUNCHES

Heavy Duty Industrial Grade

Product Code	Stock Size	Point Diameter	Length (Inches)	Weight (lbs)
JHWP-4-TH	5/16	1/8	4 3/4	0.09
P-5-TH	5/16	5/32	5	0.10
JHWP-6-TH	5/16	3/16	5 1/4	0.15
JHWP-8-TH	3/8	1/4	5 3/4	0.17
JHWP-10-TH	7/16	5/16	6	0.24

Features

- For driving out and removing already loosened pins and keys after initial movement by a solid or starter punch



TOOLS@HEIGHT™ SOLID PUNCHES

Heavy Duty Industrial Grade

Product Code	Stock Size	Point Diameter	Length (Inches)	Weight (lbs)
JHWP-14-TH	3/8	1/8	5	0.15
JHWP-15-TH	3/8	5/32	5	0.15
JHWP-16-TH	3/8	3/16	5	0.16
JHWP-17-TH	1/2	1/4	5	0.16
JHWP-18-TH	3/8	7/32	5	0.15

Features

- For loosening frozen or tight pins and keys or knocking out rivets
- Also called starter punches because they are ideal for loosening frozen pins



TOOLS@HEIGHT™ PRICK PUNCHES

Heavy Duty Industrial Grade

Product Code	Stock Size	Length (Inches)	Weight (lbs)
JHWP-32-TH	1/2	6	.28

Features

- For scribing lines into metal before cutting or riveting, and for punching starting holes for short metal screws
- Point is more tapered than center punch



TOOLS@HEIGHT™ CENTER PUNCHES

Heavy Duty Industrial Grade

Product Code	Stock Size	Blade Width (Inches)	Weight (lbs)
JHWP-38-TH	1/4	4	.05
JHWP-39-TH	5/8	4 1/2	.08
JHWP-40-TH	3/8	5	.09
JHWP-42-TH	1/2	6	.07

Features

- Pierces or marks work by indentation for starting pilot drills in metal or other materials



TOOLS@HEIGHT™ LONG TAPER PUNCHES

Heavy Duty Industrial Grade

Product Code	Stock Size	Point Diameter	Length (Inches)	Weight (lbs)
JHWP-25-TH	3/8	3/32	9	0.25
JHWP-28-TH	5/8	1/4	12	0.82
JHWP-28A-TH	3/4	1/4	15	1.50

Features

- Designed for aligning the holes in metal pieces through which rivets, bolts, or screws will be inserted
- Not intended for driving pins as punch may become stuck in work
- Also called line-up aligning or drift punches



JHWP-25-TH

TOOLS@HEIGHT™ PUNCH AND CHISEL HOLDER

Comfort Grip Handle

Product Code	Description	Weight (lbs)
28449-TH	7/8	0.50

Features

- Holds chisel and punch securely
- Protect user from hand injury



28449-TH

TOOLS@HEIGHT™ PINCH BARS

Heavy Duty Industrial Grade

Product Code	Overall Length (Inches)	Stock Size	Width of Flat (Inches)	Weight (lbs)
JHWC-83-TH	19 3/8	3/4	7/8	2.32
JHWC-84-TH	30	7/8	1	5.0

Features

- Used for aligning, prying and positioning



JHWC-83-TH

TOOLS@HEIGHT™ SUPERIOR HANDSAWS WITH XT TOOTHING

ERGO® handle - Unique XT toothing - Low Friction Coating

Product Code	Blade Length (Inch)	Teeth Per Inch (TPI)	Type of cut	Weight (lbs)
2700-24-XT7-HP-TH	24	7	Aggressive	1.24

Features

- Hard point saw with substantially thicker blade which results in less power-consuming side vibrations
- Bevel ground teeth on thick blade for height precision and straight cutting with exceptionally good stability
- Screwed, one piece two-component Ergo® handle
- Handle placement provides even distribution of power along the tooth line
- Comes with reusable plastic patented tooth protector



2700-24-XT7-HP-TH

TOOLS AT HEIGHT

PUNCHES/PINCH BARS/HANDSAWS



319-TH

TOOLS@HEIGHT™ PROFESSIONAL HAND HACKSAW

Non-Slip Handles Ensures a Solid and Secure Grip.

Product Code	Description	Blade Length (Inches)	Weight (lbs)
319-TH	Professional Hand Hacksaw	12	1.26

Features

- Alternative 55° blade mounting for flush cutting
- Offers a strong steel frame that is covered with a protective dual component plastic
- Comfortable, non-slip back handle and front grip ensures a solid, secure grip
- Tension mechanism is fully integrated into the handles so there is no obstruction during use
- Supplied with reliable and shatterproof 12 inch bi-metal blade, 24 TPI.

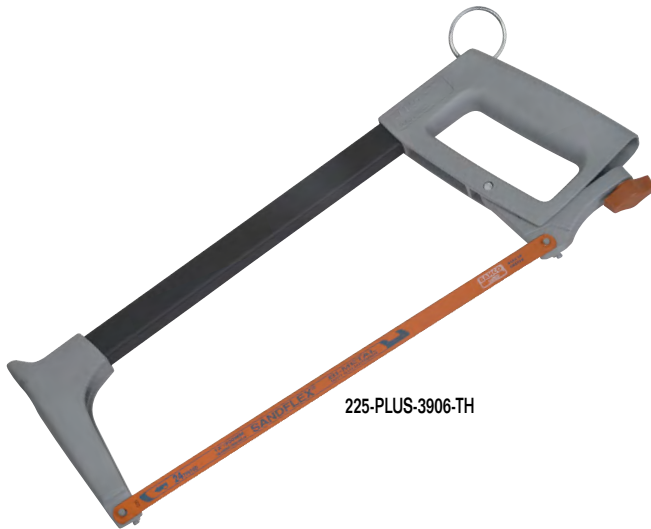

225-PLUS-3906-TH

TOOLS@HEIGHT™ TRADITIONAL HAND HACKSAW

Heavy Duty Frame with Blade Storage

Product Code	Description	Blade Length (Inches)	Weight (lbs)
225-PLUS-3906-TH	Traditional Hand Hacksaw	12	1.48

Features

- Allows very high blade tension for accurate and fast cuts
- Strong rectangular back section for blade storage with easy-to-handle retaining screws
- Can also be used as a compass saw
- Alternative 55° blade mounting for flush cutting
- Supplied with reliable and shatterproof 12 inch bi-metal blade, 24 TPI.



JHW40000-TH

TOOLS@HEIGHT™ GASKET SCRAPER

Bi-Mold Comfort Grip Handle

Product Code	Blade Length (Inch)	Overall Length	Blade Width	Weight (lbs)
JHW40000-TH	6	9 3/4	7/8	.32

Features

- Bi-mold handle provides comfortable grip, reducing hand fatigue
- Ideal for gasket removal and cleaning rust and corrosion.

TOOLS AT HEIGHT

HACKSAWS/SCRAPERS

TOOLS@HEIGHT™ 6 PIECE ENGINEERING FILE SET

Product Code	Description
1-476-04-3-2-TH	6 Piece Engineering File Set

Plastic Handled Files Contents Include:

Description	Length (Inch)	Type of Cut	Weight (lbs)
Hand Smooth	4	Smooth	.15
Warding Smooth	4	Smooth	.15
Square Smooth	4	Smooth	.15
Three Square Smooth	4	Smooth	.15
Half Round Smooth	4	Smooth	.15
Round Smooth	4	Smooth	.15

Features

- Files are smooth, double cut and designed for the fine filing and polishing applications
- Supplied with pouch
- For use with optional THUNIRET1A Retractable Lanyard



1-476-04-3-2

TOOLS@HEIGHT™ MILL FILE (USA TYPE)-TWO FLAT EDGES

Engineering File With Bi-Molded ERGO® Handle

Product Code	Length (Inch)	Width (Inch)	Height (Inch)	Teeth Per Inch (TPI)	Type of Cut	Weight (lbs)
1-143-08-1-2-TH	8	25/32	1/8	44	Bastard	.31

Features

- Surfaces and edges are single cut
- Suitable for engineering and sharpening file applications
- Can be used for polishing and deburring work in lathes
- Widely used for sharpening tools and implements such as spades, shovels, hoes, scrapers, etc.

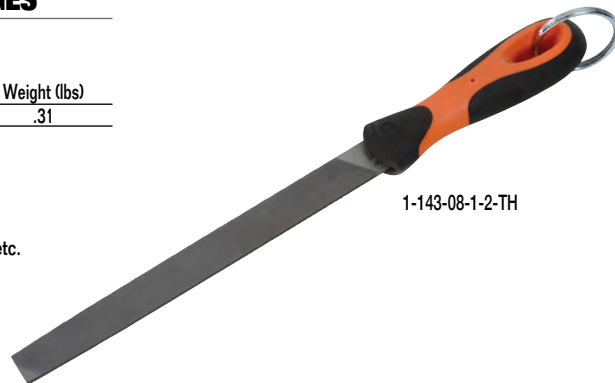

1-143-08-1-2-TH

TOOLS@HEIGHT™ ROUND FILE

Engineering File With Bi-Molded ERGO® Handle

Product Code	Length (Inch)	Width (Inch)	Height (Inch)	Teeth Per Inch (TPI)	Type of Cut	Weight (lbs)
1-230-08-2-2-TH	8	5/16	-	36	Second	.25

Features

- Regularly used for filing holes, large fillets and concave surfaces.
File is tapered to a point and has a double cut.



1-230-08-2-2-TH



2535L-TH

TOOLS@HEIGHT™ MAGNETIC PICK-UP TOOL WITH LIGHT

Product Code	Description	Extended Length (Inches)	Weight (lbs)
2535L-TH	Magnetic Pick-up Tool with Light	30	.23

Features

- Wide area lighting
- Soft grip handle
- Powerful magnetic tip
- Pick-up weight is 1¼ pounds



JHWGS-1-TH



JHWGS-3-TH

TOOLS@HEIGHT™ FEELER GAUGE SET

Heavy Duty Machine Shop Tools

Product Code	Description	Thickness	Number of Blades	Weight (lbs)
JHWGS-1-TH	Master Feeler Gauge Set	.0015 - 1/32	25	.19

Features

- 25 blades 3-5/16" x 1/2" in the following thicknesses: .0015, .002, .003, .004, .005, .006, .007, .008, .009, .010, .011, .012, .013, .014, .015, .016, .018, .020, .022, .024, .025, .028, .030, .032, and .035.
- Both decimal and equivalent metric size etched in each blade
- Gauges supplied in holder with knurled lock-nut which allows the user to select the required blade size and lock it into position

Product Code	Description	Thickness	Number of Blades	Weight (lbs)
JHWGS-3-TH	Combination Feeler Gauge Set	.002 - .025	22	.11

Features

- Contains total of 22 blades
- 10 blades 3" x 1/2" in the following thicknesses: .002, .003, .004, .005, .006, .007, .008, .010, .013, .015.
- 12 blades 1-3/4" x 1/4" in the following thicknesses: .011, .012, .013, .014, .015, .016, .017, .018, .019, .020, .022, .025.
- Overall length 5"
- Both decimal and equivalent metric size etched in each blade
- Gauges supplied in holder with knurled lock-nut which allows the user to select the required blade size and lock it into position



JHW28201-TH



JHW28203-TH



JHW28205-TH

TOOLS@HEIGHT™ AVIATION SNIPS

Bi-Mold Comfort Grip Handles

Product Code	Cutting Direction	Overall Length (Inches)	Cut Length (Inches)	Cutting Capacity (cold-rolled/stainless)	Weight (lbs)
JHW28201-TH	Left	9 3/4	1 3/8	18 ga.CR / 22 ga.SS	.93
JHW28203-TH	Right	9 3/4	1 3/8	18 ga.CR / 22 ga.SS	.93
JHW28205-TH	Straight	9 13/16	1 1/2	18 ga.CR / 22 ga.SS	.96

Features

- Color-coded handles help quickly identify the cutting direction
- Bi-mold handles provide comfortable grip, reduces hand fatigue
- Meet ANSI and DIN standards

TOOLS@HEIGHT™ TORPEDO LEVEL

Product Code	Description
THFSN25100	10" Magnetic Torped Level

Features

- Big, bright easy to read vials
- Heavy-duty, die-cast frame
- Certified Level accuracy; in top read position: (1/32" over 72")
- Level accuracy guaranteed for life; vials will never fog, leak or require adjustment
- Ideal for scaffolding as well as general construction and maintenance

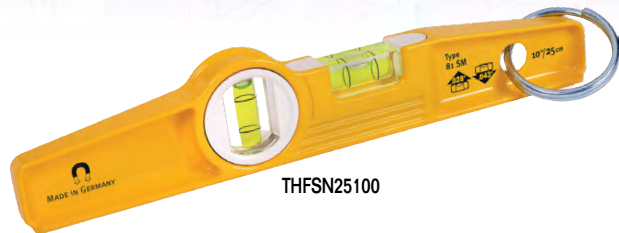

THFSN25100

TOOLS@HEIGHT™ TAPE MEASURE

Construction Grade Tape Rule

Product Code	Blade Length (Width and Length Inch)	Weight (lbs.)
JHWTM25X1-TH	1 x 25	0.85
JHWTM16X1-TH	1 x 16	1.00

Features

- Measurements on both sides of the blade
- Auto lock feature
- Triple riveted stainless steel magnetic hook on the end of the blade

Measurements on both sides of the blade

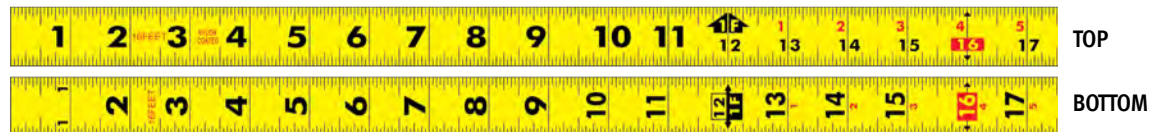

TOP

BOTTOM

JHWTM16X1-TH

TOOLS@HEIGHT™ INSPECTION MIRROR

Product Code	Description
IM1-TH	Tools@Height Tether-Ready Inspection Mirror

Features

- Installed safety-coil can be tethered to prevent dropping
- Hinged rectangular glass mirror
- Mirror is 1-3/16" x 1-1/2"



IM1-TH

TOOLS@HEIGHT™ GREASE GUN

Product Code	Description
THYA728A	Tools@Height Tether-Ready Grease Gun

Features

- Lever-operated large capacity gun develops 6,000 PSI
- Accepts 16 oz. bulk or 14-1/4 oz. cartridge grease
- Includes 18" flexible whip hose with coupler and 6" rigid extension

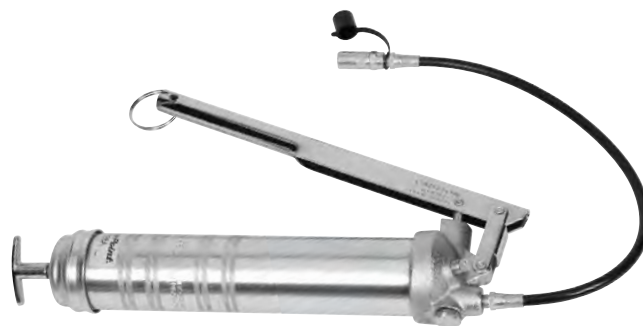

THYA728A



DR1X3.5-10PK
Max Load: 5 pounds



DR5X22510PK
Max Load: 2 pounds



DR5X225NC10PK
Max Load: 2 pounds

D-RINGS

Product Code	Description	Quantity
DR5X22510PK	D-Ring 0.5" X 2.25"	10
DR5X225100PK	D-Ring 0.5" X 2.25"	100
DR5X225NC10P	D-Ring 0.5" X 2.25" Non-Conductive	10
DR5X225NC100	D-Ring 0.5" X 2.25" Non-Conductive	100
DR1X3.5-10PK	D-Ring 1" X 3.5"	10
DR1X3.5-50PK	D-Ring 1" X 3.5"	50

Features

- D-Rings combined with Quick Wrap Tape can create attachment points on tools that are otherwise impossible to tether
- Non-conductive variant also available (DR5X225NC10PK)
- Third-party load rated for 5 pounds and 2 pounds

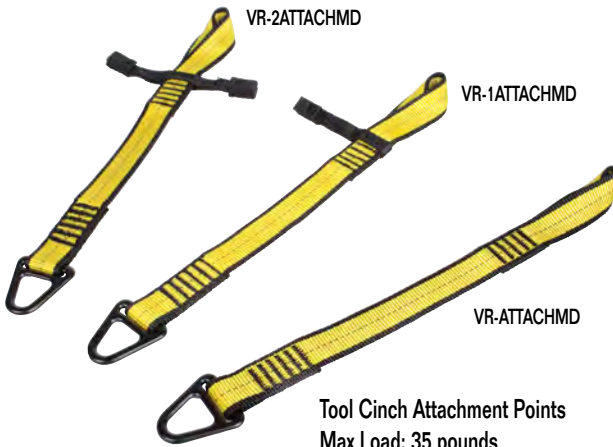

Tool Cinch Attachment Points
Max Load: 35 pounds

TOOL CINCH ATTACHMENTS

Product Code	Description	Quantity
VRATTMMD10PK	Tool Cinch Medium Duty	10
VR1ATTMD10PK	Tool Cinch Single Wing Medium Duty	10
VR2ATTMD10PK	Tool Cinch Dual Wing Medium Duty	10

Features

- Patent-pending Tool Cinch Attachment Points are third-party load rated for 35 pounds.
- The VR-1ATTACHMD and VR-2ATTACHMD feature stabilization wings that can be taped down using Quick Wrap Tape to create a strong connection that won't slide off a tool.
- With a Tool Cinch, it's possible to create attachment points on heavy, difficult to tether tools and equipment.
- The VR-ATTACHMD is perfect for tools with closed handles, or pre-drilled holes.
- The VR-1ATTACHMD is designed to be used with tools that do not have pre-drilled holes or closed handles. It can even be used on tools with triggers such as grinders, bandsaws, or drills.
- The VR-2ATTACHMD is intended to be used on long cylindrical tools where there is at least 5.5 inches of space available for the stabilization wings to be taped down.



QS-XL

QS-L

QS-M

QS-S



QS-PCOIL

QUICK SPINS

Product Code	Diameter (Inches)	Load Rating (Pounds)	Quantity
QS-S-10PK	0.6	1	10
QS-M-10PK	0.8	1	10
QS-L-10PK	1	1	10
QS-XL-10PK	1.2	1	10
QS-P-10PK	0.3	No Rated	10
QSPCOIL-10PK	0.3	No Rated	10
QS-PM-10PK	0.5	No Rated	10
QSPMCOIL10PK	0.5	No Rated	10

Features

- The unique, patented Quick Spins accommodate a wide selection of tools, making them tether-ready in seconds
- Reusable, and suitable for non-conductive use, the tangle-resistant spin tops make Quick Spins an outstanding drop prevention solution that doesn't deface tools
- Body is made from a Thermoplastic Rubber and Polyester material (TPU), while the spin tops are made of polyacetal and black carbon (POM)

QUICK WRAP TAPE

Product Code	Length (Inches)	Width (Inches)	Color	Quantity
QWHDBLU110PK	108	1	Blue	10
QWHDYLW110PK	108	1	Yellow	10

Features

- Quick Wrap Tape is made from a self-fusing silicone rubber, and features inner fiberglass webbing reinforcement.
- Quick Wrap Tape is intended to be used with D-Rings and Tool Cinch Attachment Points.



QW-HDYLW1

HEAT SHRINK

Product Code	Length (Inches)	Diameter (Inches)	Quantity
PYT1500019	1.75	0.75	25
HS1X175-25PK	1.75	1	25
HS1.5X2-25PK	2	1.5	25
HS-2X4-10PK	4	2	10
HS-3X4-10PK	4	3	10

Features

- Heat Shrink is used to create an even stronger connection that is more resistant to abrasives and harsh environments
- Links shrink 300% in size, while an inner adhesive securely fastens itself to whatever is being wrapped.

Tools not included



Tape is always used with D-Rings and cinches.
Heat Shrink is added to make a more durable surface

D-RING CORD

Product Code	Load Rating (Pounds)	Quantity
DR-CORD-10PK	5	10

Features

- The D-Ring cord (patent pending) easily cinches to tools weighing under 5 pounds, creating an instant attachment point for many tools

Tools not included



DR-CORD

MICRO D-RING

Product Code	Quantity
DR-MICRO10PK	10

Features

- The Micro D-Ring is an attachment point that can be used on small tools and equipment that are otherwise not possible to tether.
- The DR-MICRO is a flexible piece of ballistic plastic that can conform to the shape of many objects. A piece of industrial grade double-sided adhesive tape sticks to the bottom of the Micro D-Ring, allowing it to be attached to a clean surface.



EXT-C2LCOIL (see page 92)

Phone not included.



DR-MICRO

WRENCHES



COMBINATION	142
RATCHETING COMBINATION	154
DOUBLE HEAD OPEN END	162
BOX END	170
FLARE NUT	174
ADJUSTABLE	176
STRUCTURAL	178
TUBULAR	180
STRIKING	182
HEX KEY	187

ADJUSTABLE WRENCHES



TRUE ERGO™ DESIGN

with thermoplastic handle and larger grip width

Precision hardened and anti-corrosion treated

Measurement scale on head conveniently shows fastener size



Slim head with tapered jaws combine easy accessibility with extra turning strength

TUBULAR WRENCHES

Unique, versatile design allows wrench to be used with or without optional handles to quickly run down nuts

Handle can be attached to provide maximum turning power for final tightening or to reach otherwise inaccessible fasteners

A detent on the wrench shaft helps to align locking button with handle hole

Offset box wrench head provides turning clearance

Straight box wrench head provides access when clearance is limited



WRENCHES

NOT JUST HEAVY-DUTY.
INDUSTRIAL DUTY.

RATCHETING COMBINATION WRENCHES

Ratcheting gear up to 80 teeth that minimizes the swing arc in tight spaces

Low profile, easy action, reverse lever won't get in your way

SUPERTORQUE™ BOX END DESIGN

allows application of higher torque without rounding or deforming hex fasteners points

SUPERCOMBO® WRENCHES

High polish nickel-chrome plating textured finish provides great feel and wipes clean easily

Manufactured from special alloy steel, precision forged and heat treated for optimum strength and durability

Longer length wrench handle is sized for optimum comfort and balance that provides increased leverage

SUPERCOMBO® OPEN END

has specially designed grooves that direct wrench force away from fastener corners and onto the flats preventing rounding of fasteners





SUPERCOMBO® COMBINATION WRENCHES

High Polish Chrome and Satin Chrome Finish, 12 Point, SAE

Product Code	Size (Inches)	A Overall Length (Inches)	B Open End Width (Inches)	C Open End Thickness (Inches)	D Box End Diameter (Inches)	E Box End Thickness (Inches)
JHW1208SC +	1/4	4 1/4	9/16	1/8	13/32	3/16
JHW1210SC +	5/16	5 3/4	1 1/16	5/32	1/2	7/32
JHW1211SC +	11/32	6 1/4	3/4	3/16	9/16	1/4
JHW1212SC++	3/8	6 1/2	13/16	3/16	9/16	1/4
JHW1214SC++	7/16	7 1/4	15/16	7/32	1 1/16	9/32
JHW1216SC++	1/2	8	1 1/16	1/4	3/4	1 1/32
JHW1218SC++	9/16	8 3/4	1 1/4	1/4	7/8	3/8
JHW1220SC++	5/8	9 1/2	1 5/8	9/32	19/16	19/32
JHW1222SC++	11/16	10 1/4	1 1/2	5/16	1 1/2	7/16
JHW1224SC++	3/4	11	1 5/8	5/16	1 1/8	1/2
JHW1226SC++	13/16	11 3/4	1 3/4	3/8	1 7/8	17/32
JHW1228SC++	7/8	12 1/2	1 7/8	13/32	1 5/16	9/16
JHW1230SC++	15/16	13 1/4	2	7/16	1 3/8	19/32
JHW1232SC++	1	14	2 1/8	15/32	1 15/32	5/8
JHW1234SC++	1 1/16	14 3/4	2 1/4	1/2	1 9/16	21/32
JHW1236SC++	1 1/8	15 1/2	2 13/32	17/32	1 21/32	11/16
JHW1238SC++	1 3/16	16 1/4	2 17/32	17/32	1 23/32	3/4
JHW1240SC++	1 1/4	17	2 21/32	9/16	1 13/16	3/4
JHW1242 **	1 5/16	17 3/4	2 13/16	19/32	1 29/32	3/4
JHW1244 **	1 3/8	18 1/2	2 15/16	5/8	2	3/4
JHW1246 **	1 7/16	19 1/4	3 1/16	5/8	2 3/32	7/8
JHW1248 **	1 1/2	20 1/32	3 3/16	11/16	2 3/16	7/8
JHW1178A **	1 9/16	20 25/32	3 3/16	21/32	2 1/4	7/8
JHW1180 **	1 5/8	21 1/2	3 5/16	11/16	2 11/32	7/8
JHW1182 **	1 11/16	22 9/32	3 7/16	23/32	2 7/16	7/8
JHW1184 **	1 3/4	22 7/8	3 3/16	23/32	2 17/32	1 1/32
JHW1186 **	1 13/16	23 15/32	3 11/16	3/4	2 5/8	1 1/32
JHW1188 **	1 7/8	24 1/32	3 13/16	25/32	2 23/32	1 1/32
JHW1190 **	2	25 1/4	4 1/16	27/32	2 7/8	1 1/32
JHW1191 **	2 1/16	25 13/16	4 3/16	27/32	2 31/32	1 5/32
JHW1192 **	2 1/8	26 3/8	4 5/16	7/8	3 1/16	1 5/32
JHW1193 **	2 3/16	26 31/32	4 7/16	29/32	3 5/32	1 5/32
JHW1194 **	2 1/4	27 9/16	4 9/16	15/16	3 7/32	1 5/32
JHW1195 **	2 5/8	28 3/4	4 13/16	31/32	3 13/32	1 9/32
JHW1197 **	2 1/2	29 29/32	5 1/16	1 1/32	3 19/32	1 9/32
JHW1198 **	2 5/8	32	6 5/8	1 7/32	4 7/8	1 5/8
JHW1198A *	2 3/4	32	6 5/8	1 7/32	4 7/8	1 5/8
JHW1198B *	2 7/8	32	6 5/8	1 7/32	4 7/8	1 5/8
JHW1198C *	2 15/16	32	6 5/8	1 7/32	4 7/8	1 5/8
JHW1199 *	3	32	6 5/8	1 7/32	4 7/8	1 5/8
JHW1199A *	3 1/8	32	6 5/8	1 7/32	4 7/8	1 5/8
JHW1199B *	3 3/8	31 3/8	6 5/8	1 7/32	4 7/8	1 5/8
JHW1199C *	3 1/2	31 29/32	6 5/8	1 7/32	4 7/8	1 5/8

+ High Polish Chrome Finish with SUPERTORQUE™ Box End.
 ++ High Polish Chrome Finish with SUPERCOMBO® Open End and SUPERTORQUE™ Box End.
 ** Satin Chrome Finish with SUPERTORQUE™ Box End and Standard Open End.
 * Satin Chrome Finish with Standard Open and Box Ends.
 Fed. Spec.: ANSI B107.6; SAE AS 954

Features

- SUPERCOMBO® open end has specially designed grooves that direct wrench force away from fastener corners
- SUPERTORQUE™ box opening design allows application of higher torque without rounding or deforming hex fastener points
- No contact is made at the corners
- Instead, wrenching forces are placed on the flat surfaces behind the points
- Meets or exceeds aerospace specification AS 954 for 12 point fasteners (as defined by AS 870) to provide accurate torque/tension relationship for precision application
- May be used on all common hex (6 point) fasteners with considerable advantage over conventional box end wrenches to increase both hand tool flexibility and economy
- Box and open end openings are identical



Grooves in the SUPERCOMBO® open ends direct wrench force away from fastener corners.

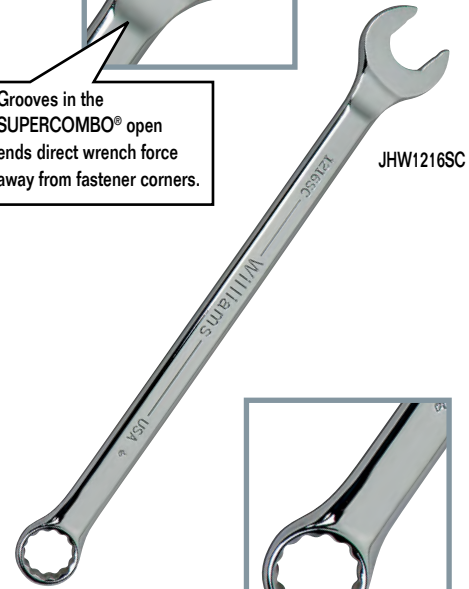

JHW1216SC



SUPERTORQUE™ box opening design allows higher torque without rounding or deforming fastener corners by placing wrenching forces on the flat surfaces rather than the points.

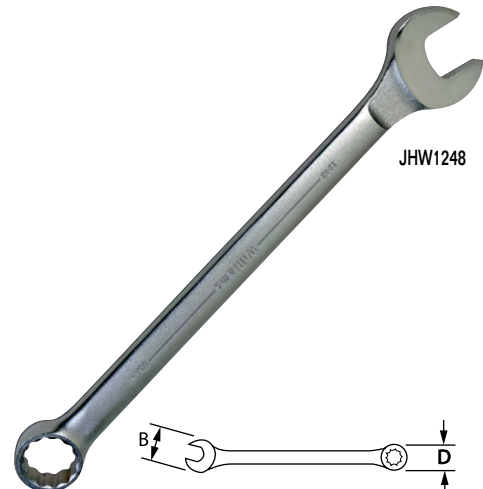

JHW1248

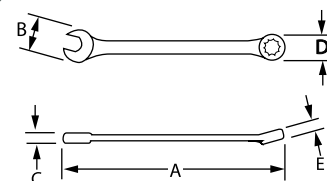

COMBINATION

WRENCHES





SUPERCOMBO® WRENCH SETS

High Polish Chrome and Satin Chrome Finish, 12 Point, SAE

Contents Include:

JHWWS1170SCA

JHWWS1171SCA

JHWWS1172SCA

JHWWS1190SCA

JHWWS-1174TA

JHWWS-1175

JHWWS-1176

JHWWS1191SC



JHWWS1170SCA



JHWWS1171SCA



JHWWS-1175



JHWWS-1174TA



JHWWS1172SCA



JHWWS1190SCA

Product Code	Size (Inches)	7-Piece Set in Pouch	11-Piece Set in Pouch	15-Piece Set in Pouch	26-Piece Set	10-Piece Set	6-Piece Set	16-Piece Set	32-Piece Set
JHW1208SC	1/4				X				X
JHW1210SC	5/16			X	X				X
JHW1212SC	3/8	X	X	X	X				X
JHW1214SC	7/16	X	X	X	X				X
JHW1216SC	1/2	X	X	X	X				X
JHW1218SC	9/16	X	X	X	X				X
JHW1220SC	5/8	X	X	X	X				X
JHW1222SC	11/16	X	X	X	X				X
JHW1224SC	3/4	X	X	X	X				X
JHW1226SC	13/16		X	X	X				X
JHW1228SC	7/8		X	X	X				X
JHW1230SC	15/16		X	X	X				X
JHW1232SC	1		X	X	X				X
JHW1234SC	1 1/16			X	X				X
JHW1236SC	1 1/8			X	X				X
JHW1240SC	1 1/4			X	X				X
JHW1242	1 5/16				X	X		X	X
JHW1244	1 3/8				X	X		X	X
JHW1246	1 7/16				X	X		X	X
JHW1248	1 1/2				X	X		X	X
JHW1180	1 5/8				X	X		X	X
JHW1182	1 11/16				X	X		X	X
JHW1184	1 3/4				X	X		X	X
JHW1186	1 13/16				X	X		X	X
JHW1188	1 7/8				X	X		X	X
JHW1190	2				X	X		X	X
JHW1191	2 1/16						X	X	X
JHW1192	2 1/8						X	X	X
JHW1193	2 3/16						X	X	X
JHW1194	2 1/4						X	X	X
JHW1195	2 3/8						X	X	X
JHW1197	2 1/2						X	X	X



COMBINATION

WRENCHES

SUPERCOMBO® COMBINATION WRENCHES



High Polished Chrome Finish, 6 Point, SAE

Product Code	Size (Inches)	A Overall Length (Inches)	B Open End Width (Inches)	C Open End Thickness (Inches)	D Box End Diameter (Inches)	E Box End Thickness (Inches)
JHW608SC	1/4	4 1/4	9/16	1/8	13/32	3/16
JHW612SC	3/8	6 1/2	13/16	3/16	9/16	1/4
JHW614SC	7/16	7 1/4	15/16	7/32	11/16	9/32
JHW616SC	1/2	8	1 1/16	1/4	3/4	11/32
JHW618SC	9/16	8 3/4	1 1/4	1/4	7/8	3/8
JHW620SC	5/8	9 1/2	1 3/8	9/32	15/16	13/32
JHW622SC	11/16	10 1/4	1 1/2	5/16	1 1/32	7/16
JHW624SC	3/4	11	1 5/8	5/16	1 1/8	1/2
JHW626SC	13/16	11 3/4	1 3/4	3/8	1 7/32	17/32
JHW628SC	7/8	12 1/2	1 7/8	13/32	1 5/16	9/16
JHW630SC	15/16	13 1/4	2	7/16	1 3/8	19/32
JHW632SC	1	14	2 1/8	15/32	1 15/32	5/8
JHW640SC	1 1/4	17	2 21/32	9/16	1 19/16	3/4



JHWWS-SC11 11 Piece SUPERCOMBO® Wrench Set, SAE

Contents Include:

Product Code:	Size (Inches)	Product Code:	Size (Inches)	Product Code:	Size (Inches)
JHW612SC	3/8	JHW614SC	7/16	JHW616SC	1/2
JHW618SC	9/16	JHW620SC	5/8	JHW622SC	11/16
JHW624SC	3/4	JHW626SC	13/16	JHW628SC	7/8
JHW630SC	15/16	JHW632SC	1		

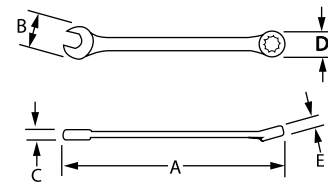

Features

- SUPERCOMBO® open end has specially designed grooves that direct wrench force away from fastener corners
- SUPERTORQUE™ box opening design allows application of higher torque without rounding or deforming hex fastener points
- No contact is made at the corners, instead wrenching forces are placed on the flat surfaces behind the points
- High polish chrome textured finish provides great feel and wipes clean easily



JHWWS-SC11

COMBINATION WRENCHES





OFFSET COMBINATION WRENCHES

High Polish Chrome Finish, 12 Point Offset Box End, SAE



JHW11954

Product Code	Size (Inches)	A Overall Length (Inches)	B Open End Width (Inches)	C Open End Thickness (Inches)	D Box End Diameter (Inches)	E Box End Thickness (Inches)
JHW11950	1/4	3 3/4	9/16	5/32	13/32	5/32
JHW11951	5/16	4 1/2	1 1/16	9/16	1/2	7/32
JHW11970	1 1/32	5	29/32	3/16	17/32	1/4
JHW11952	3/8	5	25/32	3/16	9/16	1/4
JHW11953	7/16	5 3/4	19/16	3/16	5/8	1/4
JHW11954	1/2	6 3/4	1 1/8	7/32	23/32	5/16
JHW11955	9/16	7 1/4	1 7/32	1/4	13/16	3/8
JHW11956	5/8	8 1/8	1 3/8	1/4	29/32	3/8
JHW11957	1 1/16	8 3/4	1 7/16	9/32	31/32	13/32
JHW11958	3/4	9 5/8	1 5/8	5/16	1 1/16	19/32
JHW11959	13/16	10 1/2	1 21/32	5/16	1 9/32	19/32
JHW11960	7/8	10 1/2	1 7/8	11/32	1 9/32	1/2
JHW11961	15/16	11 3/4	2 1/32	11/32	1 11/32	9/16
JHW11962	1	13	2 5/32	11/32	1 7/16	19/32
JHW11963	1 1/16	13	2 9/32	3/8	1 17/32	5/8
JHW11964	1 1/8	14 1/2	2 13/32	3/8	1 19/32	11/16
JHW11965	1 1/4	15 1/4	2 21/32	7/16	1 25/32	23/32
JHW11966	1 5/16	16 1/4	2 13/16	15/32	1 7/8	23/32
JHW11967	1 3/8	16 3/8	2 13/16	15/32	1 7/8	25/32
JHW11968	1 7/16	17	3 1/16	9/16	2 1/8	7/8
JHW11969	1 1/2	17	3 1/16	17/32	2 3/32	21/32

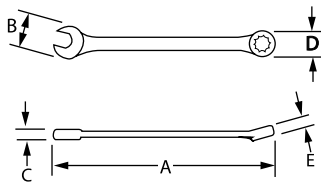

JHW11990

9 Piece Offset Combination Wrench Set, 12 Point, SAE, in Pouch

Contents Include:

Product Code	Size (Inches)	Product Code	Size (Inches)	Product Code	Size (Inches)
JHW11952	3/8	JHW11955	9/16	JHW11958	3/4
JHW11953	7/16	JHW11956	5/8	JHW11959	13/16
JHW11954	1/2	JHW11957	1 1/16	JHW11960	7/8

Features

- Unique 15° offset box end provides extra knuckle clearance
- High-polished chrome finish cleans easily
- 12 point box end provides maximum versatility
- Recessed corners in box end provide extra turning power
- Includes pouch



JHW11990



SUPERCOMBO® COMBINATION WRENCHES

Black Industrial Finish, 12 Point, SAE

Product Code	Size (Inches)	A Overall Length (Inches)	B Open End Width (Inches)	C Open End Thickness (Inches)	D Box End Diameter (Inches)	E Box End Thickness (Inches)
JHW1210BSC +	5/16	5 3/4	1 1/16	5/32	1/2	7/32
JHW1212BSC ++	3/8	6 1/2	1 3/16	3/16	9/16	1/4
JHW1214BSC ++	7/16	7 1/4	1 5/16	7/32	1 1/16	9/32
JHW1216BSC ++	1/2	8	1 7/16	1/4	3/4	1 1/32
JHW1218BSC ++	9/16	8 3/4	1 1/4	1/4	7/8	3/8
JHW1220BSC ++	5/8	9 1/2	1 3/8	9/32	15/16	13/32
JHW1222BSC ++	1 1/16	10 1/4	1 1/2	5/16	1 1/32	7/16
JHW1224BSC ++	3/4	11	1 5/8	5/16	1 1/8	1/2
JHW1226BSC ++	13/16	11 3/4	1 3/4	3/8	1 7/32	17/32
JHW1228BSC ++	7/8	12 1/2	1 7/8	13/32	1 5/16	9/16
JHW1230BSC ++	15/16	13 1/4	2	7/16	1 3/8	19/32
JHW1232BSC ++	1	14	2 1/8	15/32	1 19/32	5/8
JHW1234BSC ++	1 1/16	14 3/4	2 1/4	1/2	1 9/16	2 1/32
JHW1236BSC ++	1 1/8	15 1/2	2 13/32	17/32	1 21/32	1 11/16
JHW1240BSC ++	1 1/4	17	2 21/32	9/16	1 13/16	3/4
JHW1242B **	1 5/16	17 3/4	2 19/16	19/32	1 29/32	3/4
JHW1244B **	1 3/8	18 1/2	2 15/16	5/8	2	3/4
JHW1246B **	1 7/16	19 1/4	3 1/16	5/8	2 3/32	7/8
JHW1248B **	1 1/2	20 1/32	3 3/16	1 1/16	2 3/16	7/8
JHW1178AB **	1 9/16	20 29/32	3 3/16	2 1/32	2 1/4	7/8
JHW1180B **	1 5/8	21 1/2	3 3/16	1 1/16	2 11/32	7/8
JHW1182B **	1 11/16	22 9/32	3 7/16	23/32	2 7/16	7/8
JHW1184B **	1 3/4	22 7/8	3 9/16	23/32	2 17/32	1 1/32
JHW1186B **	1 13/16	23 19/32	3 1 1/16	3/4	2 5/8	1 1/32
JHW1188B **	1 7/8	24 1/32	3 13/16	25/32	2 23/32	1 1/32
JHW1190B **	2	25 1/4	4 1/16	27/32	2 7/8	1 1/32
JHW1191B **	2 1/16	25 19/16	4 3/16	27/32	2 31/32	1 5/32
JHW1192B **	2 1/8	26 3/8	4 5/16	7/8	3 1/16	1 5/32
JHW1193B **	2 3/16	26 31/32	4 7/16	29/32	3 3/32	1 5/32
JHW1194B **	2 1/4	27 9/16	4 9/16	15/16	3 7/32	1 5/32
JHW1195B **	2 3/8	28 3/4	4 13/16	31/32	3 13/32	1 9/32
JHW1197B **	2 1/2	29 29/32	5 1/16	1 1/32	3 19/32	1 9/32
JHW1198BL *	2 5/8	32	6 5/8	1 7/32	4 7/8	1 5/8
JHW1198ABL *	2 3/4	32	6 5/8	1 7/32	4 7/8	1 5/8
JHW1198BBL *	2 7/8	32	6 5/8	1 7/32	4 7/8	1 5/8
JHW1198CBL *	2 15/16	32	6 5/8	1 7/32	4 7/8	1 5/8
JHW1199BL *	3	32	6 5/8	1 7/32	4 7/8	1 5/8
JHW1199ABL *	3 1/8	32	6 5/8	1 7/32	4 7/8	1 5/8
JHW1199BBL *	3 3/8	31 29/32	6 5/8	1 7/32	4 7/8	1 5/8
JHW1199CBL *	3 1/2	31 29/32	6 5/8	1 7/32	4 7/8	1 5/8

+ Black Industrial Finish with SUPERTORQUE™ Box End
 ++ Black Industrial Finish with SUPERCOMBO® Open End and SUPERTORQUE™ Box End
 ** Black Industrial Finish with SUPERTORQUE™ Box End and standard open end
 * Satin Chrome Finish with Standard Open and Box Ends
 Fed. Spec.: ANSI B107.6; SAE AS 954

Features

- SUPERCOMBO® open end has specially designed grooves that direct wrench force away from fastener corners
- SUPERTORQUE™ box opening design allows application of higher torque without rounding or deforming hex fastener points
- No contact is made at the corners
- Instead, wrenching forces are placed on the flat surfaces behind the points
- Meets or exceeds aerospace specification AS 954 for 12 point fasteners (as defined by AS 870) to provide accurate torque/tension relationship for precision application
- May be used on all common hex (6 point) fasteners with considerable advantage over conventional box end wrenches to increase both hand tool flexibility and economy
- Box and open end openings are identical



Grooves in the SUPERCOMBO® open ends direct wrench force away from fastener corners.



JHW1216BSC



SUPERTORQUE™ box opening design allows higher torque without rounding or deforming fastener corners by placing wrenching forces on the flat surfaces rather than the points.

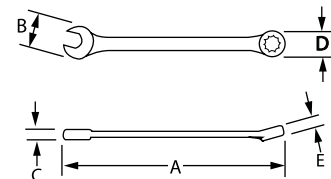



SUPERCOMBO® WRENCH SETS

**Black Industrial Finish, 12 Point, SAE
Set Contents**



JHWS1170BSC



JHWS1171BSC



JHWS1172BSC



JHWS1190BSC



JHWS1174BTA

Product Code	Size (Inches)	Set Contents				
		7-Piece Set in Pouch	11-Piece Set in Pouch	15-Piece Set in Pouch	26-Piece Set	11-Piece Set
JHW1210BSC	5/16			X	X	
JHW1212BSC	3/8	X	X	X	X	
JHW1214BSC	7/16	X	X	X	X	
JHW1216BSC	1/2	X	X	X	X	
JHW1218BSC	9/16	X	X	X	X	
JHW1220BSC	5/8	X	X	X	X	
JHW1222BSC	11/16	X	X	X	X	
JHW1224BSC	3/4	X	X	X	X	
JHW1226BSC	13/16		X	X	X	
JHW1228BSC	7/8		X	X	X	
JHW1230BSC	15/16		X	X	X	
JHW1232BSC	1		X	X	X	
JHW1234BSC	1 1/16			X	X	
JHW1236BSC	1 1/8			X	X	
JHW1240BSC	1 1/4			X	X	
JHW1242B	1 5/16				X	X
JHW1244B	1 3/8				X	X
JHW1246B	1 7/16				X	X
JHW1248B	1 1/2				X	X
JHW1178AB	1 9/16				X	X
JHW1180B	1 5/8				X	X
JHW1182B	1 11/16				X	X
JHW1184B	1 3/4				X	X
JHW1186B	1 13/16				X	X
JHW1188B	1 7/8				X	X
JHW1190B	2				X	X



COMBINATION

WRENCHES



SUPERCOMBO® COMBINATION WRENCHES

High Polish Chrome Finish, 12 Point, Metric

Product Code	Size (MM)	A Overall Length (Inches)	B Open End Width (Inches)	C Open End Thickness (Inches)	D Box End Diameter (Inches)	E Box End Thickness (Inches)
JHW1206MSC +	6	4 27/32	9/16	1/8	13/32	3/16
JHW1207MSC ++	7	5 5/16	5/8	5/32	15/32	7/32
JHW1208MSC ++	8	5 25/32	23/32	5/32	1/2	7/32
JHW1209MSC ++	9	6 9/32	13/16	3/16	9/16	1/4
JHW1210MSC ++	10	6 3/4	7/8	3/16	5/8	9/32
JHW1211MSC ++	11	7 1/4	31/32	7/32	11/16	5/16
JHW1212MSC ++	12	7 11/16	1 1/32	7/32	3/4	5/16
JHW1213MSC ++	13	8 1/32	1 1/8	1/4	25/32	11/32
JHW1214MSC ++	14	8 5/8	1 7/32	1/4	27/32	3/8
JHW1215MSC ++	15	9 9/32	1 9/32	9/32	29/32	13/32
JHW1216MSC ++	16	9 1/2	1 3/8	9/32	19/16	13/32
JHW1217MSC ++	17	10 1/16	1 15/32	5/16	1	7/16
JHW1218MSC ++	18	10 17/32	1 17/32	5/16	1 1/16	15/32
JHW1219MSC ++	19	11 1/32	1 5/8	11/32	1 1/8	1/2
JHW1220MSC ++	20	11 1/2	1 23/32	3/8	1 9/16	1/2
JHW1221MSC ++	21	11 25/32	1 3/4	3/8	1 7/32	17/32
JHW1222MSC ++	22	12 1/2	1 29/32	13/32	1 5/16	9/16
JHW1223MSC ++	23	12 7/8	1 31/32	7/16	1 11/32	9/16
JHW1224MSC ++	24	13 9/32	2	7/16	1 3/8	19/32
JHW1225MSC ++	25	14 1/32	2 5/32	15/32	1 15/32	5/8
JHW1226MSC +	26	14 5/16	2 3/16	1/2	1 1/2	21/32
JHW1227MSC +	27	14 25/32	2 9/32	1/2	1 9/16	11/16
JHW1229MSC +	29	15 17/32	2 13/32	17/32	1 21/32	23/32
JHW1230MSC +	30	16 9/32	2 17/32	17/32	1 3/4	3/4
JHW1232MSC +	32	17 1/32	2 11/16	9/16	1 13/16	3/4
JHW1234MSC +	34	17 25/32	2 13/16	19/32	1 29/32	3/4
JHW1236MSC +	36	19 9/32	3 1/16	21/32	2 3/32	7/8

+ High Polish Chrome Finish with SUPERTORQUE™ Box End

++ High Polish Chrome Finish with SUPERCOMBO® Open End and SUPERTORQUE™ Box End
Fed. Spec.: ANSI B107.6; SAE AS 954

Features

- SUPERCOMBO® open end has specially designed grooves that direct wrench force away from fastener corners
- SUPERTORQUE™ box opening design allows application of higher torque without rounding or deforming hex fastener points
- No contact is made at the corners
- Instead, wrenching forces are placed on the flat surfaces behind the points
- Meets or exceeds aerospace specification AS 954 for 12 point fasteners (as defined by AS 870) to provide accurate torque/tension relationship for precision application
- May be used on all common hex (6 point) fasteners with considerable advantage over conventional box end wrenches to increase both hand tool flexibility and economy
- Box and open end openings are identical



Made in U.S.A.

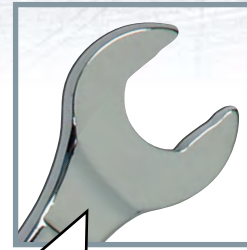

Grooves in the SUPERCOMBO® open ends direct wrench force away from fastener corners.



JHW1213MSC



JHW1232MSC



SUPERTORQUE™ box opening design allows higher torque without rounding or deforming fastener corners by placing wrenching forces on the flat surfaces rather than the points.

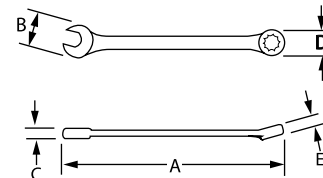

COMBINATION

WRENCHES



SUPERCOMBO® WRENCH SETS

High Polish Chrome Finish, 12 Point, Metric
Set Contents:

Product Code	Size (MM)	Set Contents							
		JHWMWS-1B 8-Piece Set in Pouch	JHWMWS-5A 10-Piece Set in Pouch	JHWMWS-10A 10-Piece Set in Pouch	JHWMWS-15A 15-Piece Set in Pouch	JHWMWS-15SA 15-Piece Set in Pouch	JHWMWS-18A 18-Piece Set in Pouch	JHWMWS-6A 10-Piece Set in Pouch	JHWMWS-27TA 27-Piece Set
JHW1206MSC	6	X							X
JHW1207MSC	7	X	X		X	X	X		X
JHW1208MSC	8	X	X		X	X	X		X
JHW1209MSC	9	X	X		X	X	X		X
JHW1210MSC	10	X	X	X	X	X	X		X
JHW1211MSC	11	X	X	X	X	X	X		X
JHW1212MSC	12	X	X	X	X	X	X		X
JHW1213MSC	13	X	X	X	X	X	X		X
JHW1214MSC	14		X	X	X	X	X		X
JHW1215MSC	15		X	X	X	X	X		X
JHW1216MSC	16			X	X	X	X		X
JHW1217MSC	17		X	X	X	X	X		X
JHW1218MSC	18			X	X	X	X	X	X
JHW1219MSC	19			X	X	X	X	X	X
JHW1220MSC	20				X	X	X		X
JHW1221MSC	21				X		X	X	X
JHW1222MSC	22					X	X	X	X
JHW1223MSC	23						X	X	X
JHW1224MSC	24					X	X	X	X
JHW1225MSC	25							X	X
JHW1226MSC	26					X			X
JHW1227MSC	27					X		X	X
JHW1229MSC	29					X			X
JHW1230MSC	30					X		X	X
JHW1232MSC	32					X		X	X
JHW1234MSC	34							X	X
JHW1236MSC	36							X	X



JHWMWS-1B



JHWMWS-5A



JHWMWS-10A



JHWMWS-15A



JHWMWS-18A



JHWMWS-6A

COMBINATION

WRENCHES



SUPERCOMBO® COMBINATION WRENCHES

High Visibility Red Finish, 12 Point, SAE

Product Code	Size (Inches)	A Overall Length (Inches)	B Open End Width (Inches)	C Open End Thickness (Inches)	D Box End Diameter (Inches)	E Box End Thickness (Inches)
JHW1212RSC ++	3/8	6 1/2	1 3/16	3/16	9/16	1/4
JHW1214RSC ++	7/16	7 1/4	1 5/16	7/32	1 1/16	9/32
JHW1216RSC ++	1/2	8	1 1/16	1/4	3/4	11/32
JHW1218RSC ++	9/16	8 3/4	1 1/4	1/4	7/8	3/8
JHW1220RSC ++	5/8	9 1/2	1 3/8	9/32	15/16	13/32
JHW1222RSC ++	11/16	10 1/4	1 1/2	5/16	1 1/32	7/16
JHW1224RSC ++	3/4	11	1 5/8	5/16	1 1/8	1/2
JHW1226RSC ++	13/16	11 3/4	1 3/4	3/8	1 7/32	17/32
JHW1228RSC ++	7/8	12 1/2	1 7/8	13/32	1 9/16	9/16
JHW1230RSC ++	15/16	13 1/4	2	7/16	1 3/8	19/32
JHW1232RSC ++	1	14	2 1/8	15/32	1 15/32	5/8
JHW1234RSC ++	1 1/16	14 3/4	2 1/4	1/2	1 9/16	21/32
JHW1236RSC ++	1 1/8	15 1/2	2 13/32	17/32	1 21/32	11/16
JHW1240RSC ++	1 1/4	17	2 21/32	9/16	1 19/16	3/4

++ Hi-Vis Red Finish with SUPERCOMBO® Open End and SUPERTORQUE™ Box End
Fed. Spec.: ANSI B107.6



JHW1216RSC

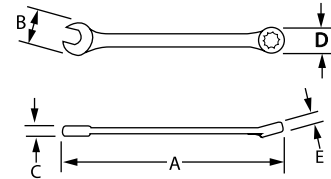

JHWWS1170RSC

7 Piece Hi-Vis Red Combination Wrench Set, 12 Point, SAE, in Pouch

Contents Include:

Product Code	Size (Inches)	Product Code	Size (Inches)	Product Code	Size (Inches)
JHW1212RSC	3/8	JHW1218RSC	9/16	JHW1224RSC	3/4
JHW1214RSC	7/16	JHW1220RSC	5/8	Pouch	
JHW1216RSC	1/2	JHW1222RSC	11/16		

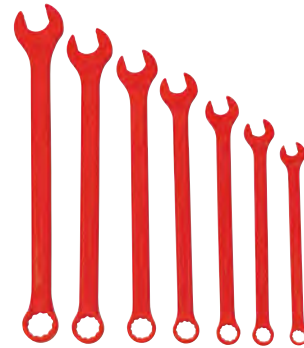

JHWWS1170RSC

JHWWS1171RSC

11 Piece Hi-Vis Red Combination Wrench Set, 12 Point, SAE, in Pouch

Contents Include:

Product Code	Size (Inches)	Product Code	Size (Inches)	Product Code	Size (Inches)
JHW1212RSC	3/8	JHW1220RSC	5/8	JHW1228RSC	7/8
JHW1214RSC	7/16	JHW1222RSC	11/16	JHW1230RSC	15/16
JHW1216RSC	1/2	JHW1224RSC	3/4	JHW1232RSC	1
JHW1218RSC	9/16	JHW1226RSC	13/16	Pouch	



JHWWS1171RSC

JHWWS1172RSC

14 Piece Hi-Vis Red Combination Wrench Set, 12 Point, SAE, in Pouch

Contents Include:

Product Code	Size (Inches)	Product Code	Size (Inches)	Product Code	Size (Inches)
JHW1212RSC	3/8	JHW1222RSC	11/16	JHW1232RSC	1
JHW1214RSC	7/16	JHW1224RSC	3/4	JHW1234RSC	1 1/16
JHW1216RSC	1/2	JHW1226RSC	13/16	JHW1236RSC	1 1/8
JHW1218RSC	9/16	JHW1228RSC	7/8	JHW1240RSC	1 1/4
JHW1220RSC	5/8	JHW1230RSC	15/16	Pouch	



JHWWS1172RSC

Features

- SUPERCOMBO® open end has specially designed grooves that direct wrench force away from fastener corners
- SUPERTORQUE™ box opening design allows application of higher torque without rounding or deforming hex fastener points
- No contact is made at the corners
- Instead, wrenching forces are placed on the flat surfaces behind the points
- Meets or exceeds aerospace specification AS 954 for 12 point fasteners (as defined by AS 870) to provide accurate torque/tension relationship for precision application
- May be used on all common hex (6 point) fasteners with considerable advantage over conventional box end wrenches to increase both hand tool flexibility and economy
- Box and open end openings are identical



Made in U.S.A.





SUPERCOMBO® COMBINATION WRENCHES

High Visibility Yellow Finish, 12 Point, SAE

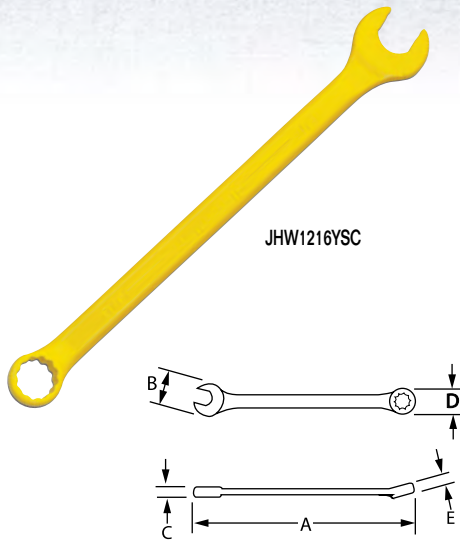

Product Code	Size (Inches)	A Overall Length (Inches)	B Open End Width (Inches)	C Open End Thickness (Inches)	D Box End Diameter (Inches)	E Box End Thickness (Inches)
JHW1212YSC ++	3/8	6 1/2	1 3/16	3/16	9/16	1/4
JHW1214YSC ++	7/16	7 1/4	1 5/16	7/32	1 1/16	9/32
JHW1216YSC ++	1/2	8	1 1/16	1/4	3/4	1 1/32
JHW1218YSC ++	9/16	8 3/4	1 1/4	1/4	7/8	3/8
JHW1220YSC ++	5/8	9 1/2	1 3/8	9/32	15/16	13/32
JHW1222YSC ++	1 1/16	10 1/4	1 1/2	5/16	1 1/32	7/16
JHW1224YSC ++	3/4	11	1 5/8	5/16	1 1/2	1/2
JHW1226YSC ++	13/16	11 3/4	1 3/4	3/8	1 7/32	17/32
JHW1228YSC ++	7/8	12 1/2	1 7/8	13/32	1 5/16	9/16
JHW1230YSC ++	15/16	13 1/4	2	7/16	1 3/8	19/32
JHW1232YSC ++	1	14	2 1/8	15/32	1 15/32	5/8
JHW1234YSC ++	1 1/16	14 3/4	2 1/4	1/2	1 9/16	2 1/32
JHW1236YSC ++	1 1/8	15 1/2	2 13/32	17/32	1 21/32	1 11/16
JHW1240YSC ++	1 1/4	17	2 2 1/32	9/16	1 13/16	3/4

++ Hi-Vis Yellow Finish with SUPERCOMBO® Open End and SUPERTORQUE™ Box End
Fed. Spec.: ANSI B107.6

JHWS1170YSC

7 Piece Hi-Vis Yellow Combination Wrench Set, 12 Point, SAE, in Pouch

Contents Include:

Product Code	Size (Inches)	Product Code	Size (Inches)	Product Code	Size (Inches)
JHW1212YSC	3/8	JHW1218YSC	9/16	JHW1224YSC	3/4
JHW1214YSC	7/16	JHW1220YSC	5/8	Pouch	
JHW1216YSC	1/2	JHW1222YSC	1 1/16		



JHWS1171YSC

11 Piece Hi-Vis Yellow Combination Wrench Set, 12 Point, SAE, in Pouch

Contents Include:

Product Code	Size (Inches)	Product Code	Size (Inches)	Product Code	Size (Inches)
JHW1212YSC	3/8	JHW1220YSC	5/8	JHW1228YSC	7/8
JHW1214YSC	7/16	JHW1222YSC	1 1/16	JHW1230YSC	15/16
JHW1216YSC	1/2	JHW1224YSC	3/4	JHW1232YSC	1
JHW1218YSC	9/16	JHW1226YSC	13/16	Pouch	

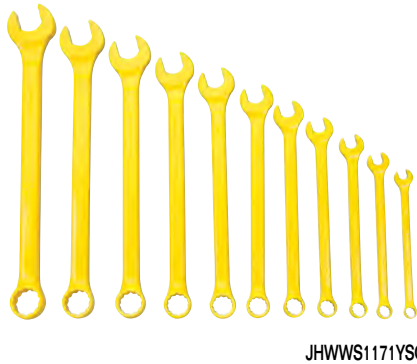

JHWS1172YSC

14 Piece Hi-Vis Yellow Combination Wrench Set, 12 Point, SAE, in Pouch

Contents Include:

Product Code	Size (Inches)	Product Code	Size (Inches)	Product Code	Size (Inches)
JHW1212YSC	3/8	JHW1222YSC	1 1/16	JHW1232YSC	1
JHW1214YSC	7/16	JHW1224YSC	3/4	JHW1234YSC	1 1/16
JHW1216YSC	1/2	JHW1226YSC	13/16	JHW1236YSC	1 1/8
JHW1218YSC	9/16	JHW1228YSC	7/8	JHW1240YSC	1 1/4
JHW1220YSC	5/8	JHW1230YSC	1 9/16	Pouch	

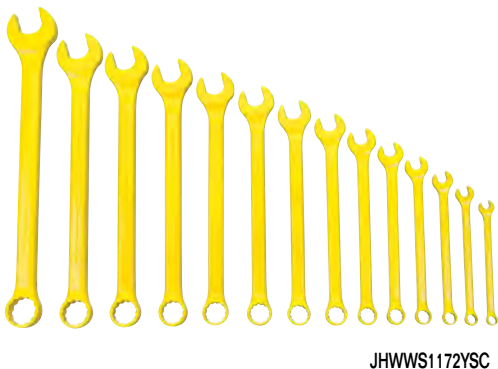

Features

- SUPERCOMBO® open end has specially designed grooves that direct wrench force away from fastener corners
- SUPERTORQUE™ box opening design allows application of higher torque without rounding or deforming hex fastener points
- No contact is made at the corners
- Instead, wrenching forces are placed on the flat surfaces behind the points
- Meets or exceeds aerospace specification AS 954 for 12 point fasteners (as defined by AS 870) to provide accurate torque/tension relationship for precision application
- May be used on all common hex (6 point) fasteners with considerable advantage over conventional box end wrenches to increase both hand tool flexibility and economy
- Box and open end openings are identical





MINIATURE COMBINATION WRENCH

High Polished Chrome Finish, 6 & 12 Point, SAE

Product Code	Size (Inches)	Point	A Box End Diameter (Inches)	B Open End Width (Inches)	C Box End Thickness (Inches)	D Open End Thickness (Inches)	E Overall Length (Inches)
JHWMIDS4A	1/8	6	7/32	11/32	1/8	1/8	2 11/16
JHWMIDS5A	5/32	6	9/32	13/32	5/32	1/8	2 27/32
JHWMIDS6A	3/16	6	5/16	7/16	5/32	1/8	2 31/32
JHWMID65A	13/64	12	3/8	1/2	1/8	1/8	3 1/8
JHWMID7A	7/32	12	3/8	1/2	3/16	1/8	3 3/32
JHWMID75A	15/64	12	3/8	1/2	2/8	1/8	3 1/4
JHWMID8A	1/4	12	13/32	17/32	3/16	5/32	3 7/32
JHWMID9A	9/32	12	7/16	19/32	7/32	5/32	3 11/32
JHWMID10A	5/16	12	1/2	21/32	7/32	5/32	3 1/2
JHWMID12A	3/8	12	19/32	25/32	1/4	3/16	3 3/4
JHWMID14A	7/16	12	21/32	29/32	5/16	7/32	4 1/32

JHWW-S-MID10 10 Piece Miniature Combination Wrench Set in Pouch Contents Include:

Product Code:	Size (Inches)	Product Code:	Size (Inches)	Product Code:	Size (Inches)
JHWMIDS5A	5/32	JHWMIDS6A	3/16	JHWMID65A	13/64
JHWMID7A	7/32	JHWMID75A	15/64	JHWMID8A	1/4
JHWMID9A	9/32	JHWMID10A	5/16	JHWMID12A	3/8
JHWMID14A	7/16				



MINIATURE COMBINATION

WRENCHES



SHORT COMBINATION WRENCH

High Polish Chrome Finish, 12 Point, Metric

Product Code	Size (MM)	A Box End Diameter (Inches)	B Open End Width (Inches)	C Box End Thickness (Inches)	D Open End Thickness (Inches)	E Overall Length (Inches)
JHW1208M	8	1/2	5/8	1/4	3/16	4 13/16
JHW1209M	9	1/2	3/4	1/4	3/16	5
JHW1210M	10	9/16	3/4	1/4	3/16	5 1/4
JHW1211M	11	11/16	1	5/16	1/4	5 7/16
JHW1212M	12	11/16	1	5/16	1/4	5 9/16
JHW1213M	13	13/16	1	3/8	1/4	5 13/16
JHW1214M	14	13/16	1 1/8	3/8	1/4	6
JHW1215M	15	7/8	1 1/4	3/8	1/4	6 1/8
JHW1216M	16	1	1 1/4	3/8	1/4	6 3/8
JHW1217M	17	1	1 3/8	7/16	5/16	6 5/8
JHW1218M	18	1 1/16	1 1/2	1	5/16	6 3/4
JHW1219M	19	1 3/16	1 1/2	1	3/8	7

MWS-MS-10 10 Piece Short Combination Wrench Set in Pouch Contents Include:

Product Code:	Sizes (mm)	Product Code:	Sizes (mm)	Product Code:	Sizes (mm)
JHW1208M	8	JHW1209M	9	JHW1210M	10
JHW1211M	11	JHW1212M	12	JHW1213M	13
JHW1214M	14	JHW1215M	15	JHW1217M	17
JHW1219M	19				



JHWMID8A



JHWW-S-MID10

Features

- Excellent wrench for fast turning of fasteners in limited clearance areas
- Box and open end openings are identical size
- High polish chrome textured finish provides great feel and wipes clean easily



JHW1213M



JHWMWS-MS10

Features

- Excellent wrench for fast turning of fasteners in limited clearance areas
- Box and open end openings are identical size
- High polish chrome textured finish provides great feel and wipes clean easily

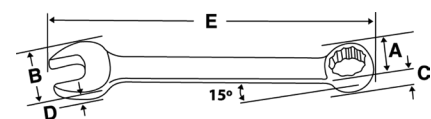

A = Outside Dia.
B = Outside Dia.
C = Head Depth
D = Head Depth
E = Length





JHW11900



JHW11940

SEMI DEEP, FLEX-HEAD COMBINATION WRENCHES



High Polish Chrome Finish, 12 Point, SAE

Product Code	Size (Inches)	A Overall Length (Inches)	B Open End Width (Inches)	C Open End Thickness (Inches)	D Socket Diameter (Inches)	E Hex Depth (Inches)
JHW11900	3/8	7	15/16	7/32	9/16	1/2
JHW11901	7/16	7	15/16	7/32	5/8	17/32
JHW11902	1/2	8	1 15/16	1/4	25/32	19/32
JHW11903	9/16	8 3/4	1 9/32	1/4	13/16	21/32
JHW11904	5/8	9 3/4	1 15/32	9/32	14/16	3/4
JHW11905	11/16	9 3/4	1 15/32	9/32	15/16	3/4
JHW11906	3/4	10 3/4	1 19/32	1/4	1	25/32

JHW11940 7 Piece Flex-Head Combination Wrench Set, 12 Point, SAE, in Pouch

Contents Include:

Product Code	Size (Inches)	Product Code	Size (Inches)	Product Code	Size (Inches)
JHW11900	3/8	JHW11903	9/16	JHW11906	3/4
JHW11901	7/16	JHW11904	5/8		
JHW11902	1/2	JHW11905	11/16		



JHW12607



JHW12691

SEMI DEEP, DOUBLE FLEX-HEAD WRENCHES



High Polish Chrome Finish, 12 Point, SAE

Product Code	Size (Inches)	A Overall Length (Inches)	B Socket Diameter (Inches)	C Hex Depth (Inches)	D Socket Diameter (Inches)	E Hex Depth (Inches)
JHW12601	3/8 x 7/16	7 13/16	9/16	15/32	5/8	17/32
JHW12603	1/2 x 9/16	9 3/4	23/32	5/8	13/16	21/32
JHW12605	5/8 x 11/16	10	27/32	23/32	15/16	3/4
JHW12607	3/4 x 7/8	12	1	3/4	1 5/32	29/32

JHW12691 4 Piece Double Flex-Head Wrench Set, 12 Point, SAE, in Pouch

Contents Include:

Product Code	Size (Inches)	Product Code	Size (Inches)
JHW12601	3/8 x 7/16	JHW12605	5/8 x 11/16
JHW12603	1/2 x 9/16	JHW12607	3/4 x 7/8

Features

- Unique semi-deep socket end provides extra bolt clearance.
- High-polished chrome finish cleans easily.
- 12 point socket end provides maximum versatility.
- Recessed corners in socket end provide extra turning power.



JHW11316



JHW11030

STUBBY COMBINATION WRENCHES



High Polish Chrome Finish, 12 Point, SAE

Product Code	Size (Inches)	A Overall Length (Inches)	B Open End Width (Inches)	C Open End Thickness (Inches)	D Box End Diameter (Inches)	E Box End Thickness (Inches)
JHW11310	5/16	3 9/16	11/16	5/32	1/2	7/16
JHW11312	3/8	3 3/4	13/16	3/16	19/32	1/2
JHW11314	7/16	3 15/16	15/16	7/32	21/32	9/16
JHW11316	1/2	4 1/4	1 1/16	1/4	3/4	11/16
JHW11318	9/16	4 1/2	1 1/16	9/32	27/32	3/4
JHW11320	5/8	4 3/4	1 1/16	9/32	15/16	13/16
JHW11322	11/16	5	1 1/16	5/16	1 1/32	7/8
JHW11324	3/4	5 1/16	1 1/16	11/32	1 1/8	15/16

Fed. Spec.: ANSI B107.6

JHW11030 7 Piece Stubby Combination Wrench Set, 12 Point, SAE, in Pouch

Contents Include:

Product Code	Size (Inches)	Product Code	Size (Inches)	Product Code	Size (Inches)
JHW11312	3/8	JHW11318	9/16	JHW11324	3/4
JHW11314	7/16	JHW11320	5/8		
JHW11316	1/2	JHW11322	11/16		

Features

- Extra short handle for access where clearance is limited
- High-polished chrome finish cleans easily
- 12 point box end provides maximum versatility
- Recessed corners in box end provide extra turning power

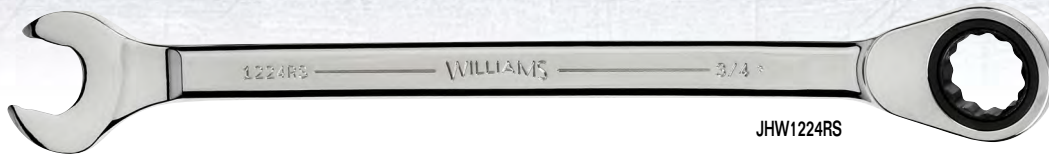

JHW1224RS

STANDARD RATCHETING COMBINATION WRENCHES

- Nickel-chrome plating helps protect against corrosion and makes cleaning easy
- Sized for optimum comfort and balance
- Ratcheting gear features up to 80 teeth, minimizing swing arc in tight spaces
- Manufactured from special alloy steel, precision-forged and heat treated for optimum strength and durability
- SUPERCAMBO® open end has specially designed grooves that direct wrench force away from fastener corners
- SUPERTORQUE™ box opening design allows the application of higher torque without rounding or deforming hex fastener points. No contact is made at the corners. Instead, wrenching forces are placed on the flat surfaces behind the points.

High Polish Chrome Finish, 12 Point, SAE



Product Code	Size (Inches)	A Overall Length (Inches)	B Open End Width (Inches)	C Open End Thickness (Inches)	D Box End Width (Inches)	E Box End Thickness (Inches)
JHW1208RS	1/4	4 15/16	9/16	1/8	2 1/32	1/4
JHW1210RS	5/16	5 7/8	1 1/16	5/32	1 1/16	9/32
JHW1211RS	1 1/32	6 15/32	2 5/32	3/16	2 5/32	5/16
JHW1212RS	3/8	7 1/32	7/8	3/16	2 7/32	5/16
JHW1214RS	7/16	7 3/8	3 1/32	7/32	7/8	1 1/32
JHW1216RS	1/2	8 11/16	1 3/32	7/32	3 1/32	1 3/32
JHW1218RS	9/16	9 1/4	1 7/32	1/4	1 1/16	1 3/32
JHW1220RS	5/8	10 9/32	1 11/32	9/32	1 3/16	7/16
JHW1222RS	1 1/16	10 29/32	1 7/16	1/2	1 1/4	1 1/32
JHW1224RS	3/4	12	1 5/8	1 1/32	1 7/16	1/2

High Polish Chrome Finish, 12 Point, Metric



Product Code	Size (MM)	A Overall Length (MM)	B Open End Width (MM)	C Open End Thickness (MM)	D Box End Width (MM)	E Box End Thickness (MM)
JHW1210MRS	10	179	22	5	22	8
JHW1211MRS	11	194	24	5	22	9
JHW1212MRS	12	207	26	6	24	9
JHW1213MRS	13	221	28	6	25	10
JHW1214MRS	14	235	31	7	27	10
JHW1215MRS	15	250	33	5	28	11
JHW1216MRS	16	261	34	7	31	11
JHW1217MRS	17	277	37	8	32	12
JHW1218MRS	18	291	39	8	35	12
JHW1219MRS	19	305	41	8	37	13

JHWWS1170RS 7 Piece Standard Ratcheting Combination Wrench Set, SAE, in Pouch

Contents Include:

Product Code	Size (Inches)	Product Code	Size (Inches)
JHW1212RS	3/8	JHW1220RS	5/8
JHW1214RS	7/16	JHW1222RS	1 1/16
JHW1216RS	1/2	JHW1224RS	3/4
JHW1218RS	9/16		

JHWWS1180RS 10 Piece Standard Ratcheting Combination Wrench Set, SAE, in Pouch

Contents Include:

Product Code	Size (Inches)	Product Code	Size (Inches)
JHW1208RS	1/4	JHW1216RS	1/2
JHW1210RS	5/16	JHW1218RS	9/16
JHW1211RS	1 1/32	JHW1220RS	3/8
JHW1212RS	3/8	JHW1222RS	1 1/16
JHW1214RS	7/16	JHW1224RS	3/4

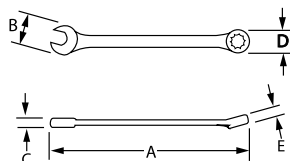

JHWMWS10RS 10 Piece Standard Ratcheting Combination Wrench Set, Metric, in Pouch

Contents Include:

Product Code	Size (MM)	Product Code	Size (MM)
JHW1210MRS	10	JHW1215MRS	15
JHW1211MRS	11	JHW1216MRS	16
JHW1212MRS	12	JHW1217MRS	17
JHW1213MRS	13	JHW1218MRS	18
JHW1214MRS	14	JHW1219MRS	19



JHWWS1170RS

RATCHETING COMBINATION

WRENCHES





REVERSIBLE RATCHETING COMBINATION WRENCHES

- Box ends are offset 15-degrees for knuckle clearance
- Sized for optimum comfort and balance
- Ratcheting gear features up to 80 teeth, minimizing swing arc in tight spaces
- Low-profile, easy-action, reverse lever won't get in your way
- Manufactured from special alloy steel, precision-forged and heat-treated for optimum strength and durability
- SUPERCOMBO® open end has specially designed grooves that direct wrench force away from fastener corners
- SUPERTORQUE™ box opening design allows the application of higher torque without rounding or deforming hex fastener points. No contact is made at the corners. Instead, wrenching forces are placed on the flat surfaces behind the points

High Polish Chrome Finish,
12 Point, SAE



Product Code	Size (Inches)	A Overall Length (Inches)	B Open End Width (Inches)	C Open End Thickness (Inches)	D Box End Width (Inches)	E Box End Thickness (Inches)
JHW1210RCU	5/16	5 7/8	1 1/16	5/32	1 1/16	9/32
JHW1212RCU	3/8	7 1/32	7/8	3/16	2 7/32	5/16
JHW1214RCU	7/16	7 5/8	3 3/32	7/32	7/8	1 1/32
JHW1216RCU	1/2	8 1 1/16	1 3/32	7/32	3 1/32	1 3/32
JHW1218RCU	9/16	9 1/4	1 7/32	1/4	1 1/16	1 3/32
JHW1220RCU	5/8	10 9/32	1 1 1/32	9/32	1 3/16	7/16
JHW1222RCU	1 1/16	10 29/32	1 7/16	1/2	1 1/4	1 9/32
JHW1224RCU	3/4	12	1 5/8	1 1/32	1 7/16	1/2

JHWWS1170RCU 7 Piece Reversible Ratcheting Combination Wrench Set, SAE, in Pouch

Contents Include:

Product Code	Size (Inches)	Product Code	Size (Inches)
JHW1212RCU	3/8	JHW1220RCU	5/8
JHW1214RCU	7/16	JHW1222RCU	1 1/16
JHW1216RCU	1/2	JHW1224RCU	3/4
JHW1218RCU	9/16		



High Polish Chrome Finish,
12 Point, Metric



Product Code	Size (MM)	A Overall Length (MM)	B Open End Width (MM)	C Open End Thickness (MM)	D Box End Width (MM)	E Box End Thickness (MM)
JHW1208MRCU	8	149	18	4	18	7
JHW1209MRCU	9	164	20	4	20	8
JHW1210MRCU	10	179	22	5	22	8
JHW1211MRCU	11	194	24	5	22	9
JHW1212MRCU	12	207	26	6	24	9
JHW1213MRCU	13	221	28	6	25	10
JHW1214MRCU	14	235	31	7	27	10
JHW1215MRCU	15	250	33	7	28	11
JHW1216MRCU	16	261	34	7	31	11
JHW1217MRCU	17	277	37	8	32	12
JHW1218MRCU	18	291	39	8	35	12
JHW1219MRCU	19	305	41	8	37	13

JHWMWS10RCU 10 Piece Reversible Ratcheting Combination Wrench Set, Metric, in Pouch

Contents Include:

Product Code	Size (MM)	Product Code	Size (MM)
JHW1210MRCU	10	JHW1215MRCU	15
JHW1211MRCU	11	JHW1216MRCU	16
JHW1212MRCU	12	JHW1217MRCU	17
JHW1213MRCU	13	JHW1218MRCU	18
JHW1214MRCU	14	JHW1219MRCU	19



STUBBY REVERSIBLE RATCHETING COMBINATION WRENCHES

- SUPERCOMBO® open end has specially designed grooves that direct wrench force away from fastener corners
- Manufactured from special alloy steel, precision forged and head treated for optimum strength and durability
- Nickel-chrome plating helps protect against corrosion and makes cleaning easy
- Ratcheting gear features up to 80 teeth, minimizing swing arc in tight places
- Sized for optimum comfort and balance
- SUPERTORQUE™ box opening design allows application of higher torque without rounding or deforming hex fasteners points. No contact is made at the corners. Instead, wrenching forces are placed on the flat surfaces behind the points

High Polish Chrome Finish,
12 Point, SAE



Product Code	Size (Inches)	A Overall Length (Inches)	B Open End Width (Inches)	C Open End Thickness (Inches)	D Box End Width (Inches)	E Box End Thickness (Inches)
JHW1210RSS	5/16	3 1/2	1 1/16	5/32	1 1/16	9/32
JHW1212RSS	3/8	3 27/32	7/8	3/16	2 7/32	5/16
JHW1214RSS	7/16	4	3 3/32	7/32	7/8	1 1/32
JHW1216RSS	1/2	4 1 1/32	1 3/32	7/32	3 1/32	1 3/32
JHW1218RSS	9/16	4 1/2	1 7/32	1/4	1 1/16	1 3/32
JHW1220RSS	5/8	4 27/32	1 1 1/32	9/32	1 3/16	7/16
JHW1222RSS	1 1/16	5	1 7/16	1/2	1 1/4	1 9/32
JHW1224RSS	3/4	5 1 1/32	1 5/8	1 1/32	1 7/16	1/2

JHWWS1170RSS 7 Piece Stubby Reversible Ratcheting Combination Wrench Set, SAE, in Pouch

Contents Include:

Product Code	Size (Inches)	Product Code	Size (Inches)
JHW1212RSS	3/8	JHW1220RSS	5/8
JHW1214RSS	7/16	JHW1222RSS	1 1/16
JHW1216RSS	1/2	JHW1224RSS	3/4
JHW1218RSS	9/16		



High Polish Chrome Finish,
12 Point, Metric



Product Code	Size (MM)	A Overall Length (MM)	B Open End Width (MM)	C Open End Thickness (MM)	D Box End Width (MM)	E Box End Thickness (MM)
JHW1208MRSS	8	89	18	4	18	7
JHW1209MRSS	9	93	20	4	20	8
JHW1210MRSS	10	98	22	5	22	8
JHW1211MRSS	11	102	24	5	22	9
JHW1212MRSS	12	106	26	6	24	9
JHW1213MRSS	13	110	28	6	25	10
JHW1214MRSS	14	114	31	7	27	10
JHW1215MRSS	15	119	33	7	28	11
JHW1216MRSS	16	123	34	7	31	11
JHW1217MRSS	17	127	37	8	32	12
JHW1218MRSS	18	135	39	8	35	12
JHW1219MRSS	19	135	41	8	37	13

JHWMWS10RSS 10 Piece Stubby Reversible Ratcheting Combination Wrench Set, Metric, in Pouch

Contents Include:

Product Code	Size (MM)	Product Code	Size (MM)
JHW1210MRSS	10	JHW1215MRSS	15
JHW1211MRSS	11	JHW1216MRSS	16
JHW1212MRSS	12	JHW1217MRSS	17
JHW1213MRSS	13	JHW1218MRSS	18
JHW1214MRSS	14	JHW1219MRSS	19



REVERSIBLE RATCHETING COMBINATION WRENCHES



High Polish Chrome Finish, 12 Point, SAE

Product Code	Size (Inches)	A Overall Length (Inches)	B Open End Width (Inches)	C Open End Thickness (Inches)	D Box End Diameter (Inches)	E Box End Thickness (Inches)
JHW1208RC	1/4	4 1/2	2 1/32	5/32	2 1/32	9/32
JHW1210RC	5/16	5 1/4	2 9/32	5/32	2 9/32	9/32
JHW1212RC	3/8	6 1/4	7/8	3/16	7/8	9/16
JHW1214RC	7/16	6 5/8	1 5/16	7/32	2 9/32	1 1/32
JHW1216RC	1/2	7	1 1/32	1/4	1	1 9/32
JHW1218RC	9/16	7 3/8	1 3/16	1/4	1 3/32	1 9/32
JHW1220RC	5/8	8 7/32	1 11/32	9/32	1 7/32	7/16
JHW1222RC	1 1/16	9	1 7/16	9/32	1 11/16	1/2
JHW1224RC	3/4	9 3/4	1 17/32	1 1/32	1 15/32	1 1/32
JHW1226RC	1 9/16	10 1/2	1 23/32	3/8	1 9/16	1 9/32
JHW1228RC	7/8	11 13/32	1 7/8	1 1/32	1 21/32	1 9/32
JHW1230RC	1 5/16	12	1 31/32	1 5/32	1 27/32	5/8
JHW1232RC	1	13	2 3/32	1 5/32	1 7/8	5/8



JHW1226RC



JHWS-1168RC

JHWS-1168RC 8 Piece Reversible Ratcheting Combination Wrench Set, SAE, in Plastic Tray

Contents Include:

Product Code	Size (Inches)	Product Code	Size (Inches)	Product Code	Size (Inches)
JHW1210RC	5/16	JHW1216RC	1/2	JHW1222RC	1 1/16
JHW1212RC	3/8	JHW1218RC	9/16	JHW1224RC	3/4
JHW1214RC	7/16	JHW1220RC	5/8		

JHWS-1164RC 4 Piece Reversible Ratcheting Combination Wrench Set, SAE, in Plastic Tray

Contents Include:

Product Code	Size (Inches)	Product Code	Size (Inches)
JHW1226RC	1 9/16	JHW1230RC	1 5/16
JHW1228RC	7/8	JHW1232RC	1

Features

- High-polished chrome finish cleans easily
- Ratchet lever is easily accessible for quick direction changes
- Recessed corners in ends provide extra turning power

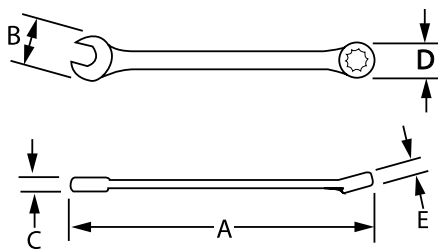

JHWS-1164RC

RATCHETING COMBINATION

WRENCHES



JHW1219MRC



JHWMWS-12RC



JHWMWS-4RC



JHWW4RWA

REVERSIBLE RATCHETING COMBINATION WRENCHES



High Polish Chrome Finish, 12 Point, Metric

Product Code	Size (MM)	A				
		Overall Length (Inches)	B Open End Width (Inches)	C Open End Thickness (Inches)	D Box End Diameter (Inches)	E Box End Thickness (Inches)
JHW1206MRC	6	4 1/2	21/32	5/32	21/32	1/4
JHW1208MRC	8	5 1/4	23/32	3/16	23/32	9/32
JHW1209MRC	9	5 7/8	13/16	5/32	25/32	5/16
JHW1210MRC	10	6 1/4	7/8	7/32	7/8	11/32
JHW1211MRC	11	6 5/8	15/16	7/32	29/32	11/32
JHW1212MRC	12	6 13/16	1	7/32	31/32	3/8
JHW1213MRC	13	7	1 1/32	1/4	1	13/32
JHW1214MRC	14	7 3/8	1 3/16	1/4	1 3/32	13/32
JHW1215MRC	15	7 3/4	1 1/4	9/32	1 5/32	7/16
JHW1216MRC	16	8 3/16	1 11/32	9/32	1 7/32	7/16
JHW1217MRC	17	9	1 7/16	9/32	1 9/32	1/2
JHW1218MRC	18	9 3/8	1 17/32	5/16	1 3/8	15/32
JHW1219MRC	19	9 3/4	1 17/32	11/32	1 7/16	17/32
JHW1221MRC	21	10 3/4	1 23/32	3/8	1 9/16	9/16
JHW1222MRC	22	11 1/4	1 27/32	3/8	1 21/32	19/32
JHW1224MRC	24	12	1 31/32	15/32	1 27/32	5/8
JHW1225MRC	25	12 31/32	2 3/32	15/32	1 7/8	5/8

JHWMWS-12RC

12 Piece Reversible Ratcheting Combination Wrench Set, Metric, in Plastic Tray

Contents Include:

Product Code	Size (MM)	Product Code	Size (MM)	Product Code	Size (MM)
JHW1208MRC	8	JHW1212MRC	12	JHW1216MRC	16
JHW1209MRC	9	JHW1213MRC	13	JHW1217MRC	17
JHW1210MRC	10	JHW1214MRC	14	JHW1218MRC	18
JHW1211MRC	11	JHW1215MRC	15	JHW1219MRC	19

JHWMWS-4RC

4 Piece Reversible Ratcheting Combination Wrench Set, Metric, in Pouch

Contents Include:

Product Code	Size (MM)	Product Code	Size (MM)
JHW1221MRC	21	JHW1224MRC	24
JHW1222MRC	22	JHW1225MRC	25

Features

- High-polished chrome finish cleans easily
- Ratchet lever is easily accessible for quick direction changes
- Recessed corners in ends provide extra turning power

4 PIECE RATCHETING ADAPTOR SET

Product Code	Description
JHWW4RWA	4 Piece Ratcheting Adaptor Set

Contents Include:

Description	Description
1/4" Drive male Adaptor	3/8" Drive Male Adaptor
1/4" Hex Shank Coupler	1/2" Drive Male Adaptor

Features

- Converts a ratcheting wrench into a ratchet
- To be used with Ratcheting Combination Wrenches
- Allows the use of hex bits, 1/4", 3/8", 1/2" Drive Sockets
- Adaptor locks into the wrench by twisting the top cap
- Push-button socket release



RATCHETING COMBINATION WRENCHES

High Polish Chrome Finish, 12 Point, SAE

Product Code	Size (Inches)	A Overall Length (Inches)	B Open End Width (Inches)	C Open End Thickness (Inches)	D Box End Diameter (Inches)	E Box End Thickness (Inches)
JHW1208NRC	1/4	5 1/3	3/4	1/4	3/4	1/4
JHW1210NRC	5/16	5 1/3	3/4	1/4	3/4	1/4
JHW1212NRC	3/8	6 1/3	3/4	1/4	3/4	1/4
JHW1214NRC	7/16	6 1/2	1	1/4	3/4	1/4
JHW1216NRC	1/2	7	1	1/4	1	1/4
JHW1218NRC	9/16	7 1/2	1 1/4	1/3	1	1/4
JHW1220NRC	5/8	8 1/2	1 5/16	1/3	1 1/4	3/8
JHW1222NRC	11/16	9	1 1/2	1/3	1 5/16	3/8
JHW1224NRC	3/4	10	1 1/2	5/8	1 5/16	3/8
JHW1226NRC	13/16	11 1/4	1 3/4	5/8	1 5/8	1/2
JHW1228NRC	7/8	11 1/4	1 3/4	5/8	1 5/8	1/2
JHW1230NRC	15/16	13	2	5/8	1 3/4	1/2
JHW1232NRC	1	13	2	5/8	1 3/4	1/2
JHW1234NRC	1 1/16	14	2 1/2	1/2	2	1/2
JHW1236NRC	1 1/8	16 3/4	2 1/2	1/2	2 5/16	5/8
JHW1238NRC	1 1/4	16 3/4	2 1/2	1/2	2 5/16	5/8



JHW1208NRC

JHWWS-1120NRC

9 Piece Combination Wrench Set, in Pouch

Contents Include:

Product Code	Size (Inches)	Product Code	Size (Inches)
JHW1208NRC	1/4	JHW1218NRC	9/16
JHW1210NRC	5/16	JHW1220NRC	5/8
JHW1212NRC	3/8	JHW1222NRC	11/16
JHW1214NRC	7/16	JHW1224NRC	3/4
JHW1216NRC	1/2		



JHWWS-1120NRC

JHWWS-1121NRC

11 Piece Combination Wrench Set, in Pouch

Contents Include:

Product Code	Size (Inches)	Product Code	Size (Inches)	Product Code	Size (Inches)
JHW1212NRC	3/8	JHW1220NRC	5/8	JHW1228NRC	7/8
JHW1214NRC	7/16	JHW1222NRC	11/16	JHW1230NRC	15/16
JHW1216NRC	1/2	JHW1224NRC	3/4	JHW1232NRC	1
JHW1218NRC	9/16	JHW1226NRC	13/16		



JHWWS-1121NRC

JHWWS-1122NRC

16 Piece Combination Wrench Set, in Pouch

Contents Include:

Product Code	Size (Inches)	Product Code	Size (Inches)	Product Code	Size (Inches)
JHW1208NRC	1/4	JHW1220NRC	5/8	JHW1232NRC	1
JHW1210NRC	5/16	JHW1222NRC	11/16	JHW1234NRC	1 1/16
JHW1212NRC	3/8	JHW1224NRC	3/4	JHW1236NRC	1 1/8
JHW1214NRC	7/16	JHW1226NRC	13/16	JHW1238NRC	1 1/4
JHW1216NRC	1/2	JHW1228NRC	7/8		
JHW1218NRC	9/16	JHW1230NRC	15/16		



JHWWS-1122NRC

Features

- 72-tooth gear requires only 5° of ratcheting arc to engage next gear
- High polish satin-chrome finish cleans easily & protects against corrosion
- Thin profile is perfect for tight clearances where accessibility is critical
- 12-point ratcheting box end allows for superior fastener engagement

RATCHETING COMBINATION

WRENCHES





JHW1206MNRC

RATCHETING COMBINATION WRENCHES

High Polish Chrome Finish, 12 Point, Metric

Product Code	Size (MM)	A Overall Length (Inches)	B Open End Width (Inches)	C Open End Thickness (Inches)	D Box End Diameter (Inches)	E Box End Thickness (Inches)
JHW1206MNRC	6	5 3/8	3/4	1/4	1/4	1/4
JHW1207MNRC	7	5 3/8	3/4	1/4	1/4	1/4
JHW1208MNRC	8	5 3/8	3/4	1/4	1/4	1/4
JHW1209MNRC	9	5 5/8	3/4	1/4	1/4	1/4
JHW1210MNRC	10	6 1/2	7/8	1/4	7/8	1/4
JHW1211MNRC	11	6 5/8	1	1/4	7/8	3/8
JHW1212MNRC	12	6 7/8	1	1/4	1	3/8
JHW1213MNRC	13	7 1/8	1	1/4	1	3/8
JHW1214MNRC	14	7 5/8	1 1/4	3/8	1	3/8
JHW1215MNRC	15	7 7/8	1 1/2	3/8	1	3/8
JHW1216MNRC	16	8 1/2	1 1/2	3/8	1 1/4	3/8
JHW1217MNRC	17	9 1/8	1 1/2	3/8	1 1/4	3/8
JHW1218MNRC	18	9 3/8	1 1/2	3/8	1 1/4	1/2
JHW1219MNRC	19	9 7/8	1 5/8	3/8	1 1/4	1/2
JHW1220MNRC	20	11	1 7/8	3/8	1 5/8	1/2
JHW1221MNRC	21	11	1 7/8	3/8	1 5/8	1/2
JHW1222MNRC	22	11	1 7/8	3/8	1 5/8	1/2
JHW1223MNRC	23	11	1 7/8	3/8	1 5/8	1/2
JHW1224MNRC	24	12 3/4	2	3/8	1 7/8	1/2
JHW1225MNRC	25	12 3/4	2	3/8	1 7/8	1/2
JHW1226MNRC	26	12 3/4	2	3/8	1 7/8	1/2
JHW1227MNRC	27	14 1/8	2 1/8	1/2	2	1/2
JHW1228MNRC	28	14 1/8	2 1/8	1/2	2	1/2
JHW1230MNRC	30	16 3/4	2 1/2	1/2	2 3/8	5/8
JHW1232MNRC	32	16 3/4	2 1/2	1/2	2 3/8	5/8



JHMWS1123NRC

JHMWS1123NRC 9 Piece Combination Wrench, in Pouch Contents Include:

Product Code	Size (MM)	Product Code	Size (MM)	Product Code	Size (MM)
JHW1206MNRC	6	JHW1209MNRC	9	JHW1212MNRC	12
JHW1207MNRC	7	JHW1210MNRC	10	JHW1213MNRC	13
JHW1208MNRC	8	JHW1211MNRC	11	JHW1214MNRC	14



JHMWS1124NRC

JHMWS1124NRC 14 Piece Combination Wrench, in Pouch Contents Include:

Product Code	Size (MM)	Product Code	Size (MM)	Product Code	Size (MM)	Product Code	Size (MM)
JHW1206MNRC	6	JHW1210MNRC	10	JHW1214MNRC	14	JHW1218MNRC	18
JHW1207MNRC	7	JHW1211MNRC	11	JHW1215MNRC	15	JHW1219MNRC	19
JHW1208MNRC	8	JHW1212MNRC	12	JHW1216MNRC	16		
JHW1209MNRC	9	JHW1213MNRC	13	JHW1217MNRC	17		



JHMWS1125NRC

JHMWS1125NRC 19 Piece Combination Wrench, in Pouch Contents Include:

Product Code	Size (MM)	Product Code	Size (MM)	Product Code	Size (MM)	Product Code	Size (MM)
JHW1206MNRC	6	JHW1211MNRC	11	JHW1216MNRC	16	JHW1221MNRC	21
JHW1207MNRC	7	JHW1212MNRC	12	JHW1217MNRC	17	JHW1222MNRC	22
JHW1208MNRC	8	JHW1213MNRC	13	JHW1218MNRC	18	JHW1223MNRC	23
JHW1209MNRC	9	JHW1214MNRC	14	JHW1219MNRC	19	JHW1224MNRC	24
JHW1210MNRC	10	JHW1215MNRC	15	JHW1220MNRC	20		



JHMWS1126NRC

JHMWS1126NRC 25 Piece Combination Wrench, in Pouch Contents Include:

Product Code	Size (MM)	Product Code	Size (MM)	Product Code	Size (MM)	Product Code	Size (MM)
JHW1206MNRC	6	JHW1213MNRC	13	JHW1220MNRC	20	JHW1227MNRC	27
JHW1207MNRC	7	JHW1214MNRC	14	JHW1221MNRC	21	JHW1228MNRC	28
JHW1208MNRC	8	JHW1215MNRC	15	JHW1222MNRC	22	JHW1230MNRC	30
JHW1209MNRC	9	JHW1216MNRC	16	JHW1223MNRC	23	JHW1232MNRC	32
JHW1210MNRC	10	JHW1217MNRC	17	JHW1224MNRC	24		
JHW1211MNRC	11	JHW1218MNRC	18	JHW1225MNRC	25		
JHW1212MNRC	12	JHW1219MNRC	19	JHW1226MNRC	26		

Features

- 72-tooth gear requires only 5° of ratcheting arc to engage next gear
- High polish satin-chrome finish cleans easily & protects against corrosion
- Thin profile is perfect for tight clearances where accessibility is critical
- 12-point ratcheting box end allows for superior fastener engagement

STUBBY REVERSIBLE RATCHETING COMBINATION WRENCHES



High Polish Chrome Finish, 12 Point, SAE

Product Code	Size (Inches)	A Overall Length (Inches)	B Open End Width (Inches)	C Open End Thickness (Inches)	D Box End Diameter (Inches)	E Box End Thickness (Inches)
JHW1210RCS	5/16	3 1/2	23/32	5/32	23/32	9/32
JHW1212RCS	3/8	3 29/32	7/8	9/16	7/8	11/32
JHW1214RCS	7/16	4	31/32	7/32	7/8	11/32
JHW1216RCS	1/2	4 1/2	1 1/16	1/4	1	13/32
JHW1218RCS	9/16	4 11/16	1 3/16	1/4	1 3/32	13/32
JHW1220RCS	5/8	5	1 11/32	9/32	1 7/32	15/32
JHW1222RCS	11/16	5 1/4	1 1/2	9/32	1 9/16	1/2
JHW1224RCS	3/4	5 1/2	1 19/32	11/32	1 15/32	17/32

JHWWS1168RCS 8 Piece Reversible Stubby Ratcheting Combination Wrench Set, SAE, in Plastic Tray

Contents Include:

Product Code	Size (Inches)	Product Code	Size (Inches)	Product Code	Size (Inches)
JHW1210RCS	5/16	JHW1216RCS	1/2	JHW1222RCS	11/16
JHW1212RCS	3/8	JHW1218RCS	9/16	JHW1224RCS	3/4
JHW1214RCS	7/16	JHW1220RCS	5/8		

Features

- Fine tooth design with dual-pawl mechanism for extra strength
- High-polished chrome finish cleans easily
- Ratchet lever is easily accessible for quick direction changes
- Recessed corners in ends provide extra turning power



JHW1216RCS



JHWWS1168RCS

STUBBY REVERSIBLE RATCHETING COMBINATION WRENCHES



High Polish Chrome Finish, 12 Point, Metric

Product Code	Size (MM)	A Overall Length (Inches)	B Open End Width (Inches)	C Open End Thickness (Inches)	D Box End Diameter (Inches)	E Box End Thickness (Inches)
JHW1208MRCS	8	3 1/2	23/32	5/32	23/32	9/32
JHW1209MRCS	9	3 3/4	13/16	5/32	3/4	5/16
JHW1210MRCS	10	3 27/32	7/8	3/16	7/8	11/32
JHW1211MRCS	11	4 1/8	31/32	7/32	29/32	11/32
JHW1212MRCS	12	4 1/4	1	7/32	15/16	3/8
JHW1213MRCS	13	4 1/2	1	1/4	1	13/32
JHW1214MRCS	14	4 11/16	1 5/32	1/4	1 3/32	13/32
JHW1215MRCS	15	4 29/32	1 1/4	9/32	1 5/32	7/16
JHW1216MRCS	16	5	1 3/8	9/32	1 1/4	15/32
JHW1217MRCS	17	5 5/32	1 7/16	9/32	1 9/32	1/2
JHW1218MRCS	18	5 1/4	1 1/2	9/16	1 3/8	1/2
JHW1219MRCS	19	5 1/2	1 9/16	11/32	1 15/32	17/32

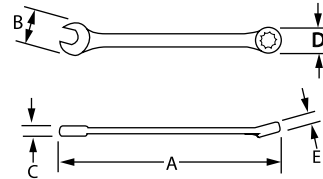

JHWMWS-12RCS 12 Piece Reversible Stubby Ratcheting Combination Wrench Set, Metric, in Plastic Tray

Contents Include:

Product Code	Size (MM)	Product Code	Size (MM)	Product Code	Size (MM)
JHW1208MRCS	8	JHW1212MRCS	12	JHW1216MRCS	16
JHW1209MRCS	9	JHW1213MRCS	13	JHW1217MRCS	17
JHW1210MRCS	10	JHW1214MRCS	14	JHW1218MRCS	18
JHW1211MRCS	11	JHW1215MRCS	15	JHW1219MRCS	19

Features

- Fine tooth design with dual-pawl mechanism for extra strength
- High-polished chrome finish cleans easily
- Ratchet lever is easily accessible for quick direction changes
- Recessed corners in ends provide extra turning power



JHW1213MRCS



JHWMWS-12RCS



JHW1216RCF



JHWS1168RCF

FLEX-HEAD REVERSIBLE RATCHETING COMBINATION WRENCHES



High Polish Chrome Finish, 12 Point, SAE

Product Code	Size (Inches)	A	B	C	D	E
		Overall Length (Inches)	Open End Width (Inches)	Open End Thickness (Inches)	Box End Diameter (Inches)	Box End Thickness (Inches)
JHW1210RCF	5/16	5 1/2	23/32	5/32	23/32	1/4
JHW1212RCF	3/8	6 5/16	29/32	7/32	7/8	5/16
JHW1214RCF	7/16	6 11/16	31/32	7/32	29/32	11/32
JHW1216RCF	1/2	7 1/4	1 1/32	1/4	1	13/32
JHW1218RCF	9/16	7 19/32	1 3/16	1/4	1 3/32	13/32
JHW1220RCF	5/8	8 13/32	1 3/8	9/32	1 1/4	7/16
JHW1222RCF	11/16	9	1 15/32	9/32	1 9/32	1/2
JHW1224RCF	3/4	10	1 9/16	11/32	1 15/32	1/2

JHWS1168RCF 8 Piece Reversible Flex-Head Ratcheting Combination Wrench Set, SAE, in Plastic Tray

Contents Include:

Product Code	Size (Inches)	Product Code	Size (Inches)	Product Code	Size (Inches)
JHW1210RCF	5/16	JHW1216RCF	1/2	JHW1222RCF	11/16
JHW1212RCF	3/8	JHW1218RCF	9/16	JHW1224RCF	3/4
JHW1214RCF	7/16	JHW1220RCF	5/8		

Features

- Flex-Head pivots 90° in either direction for access in tight areas
- Fine tooth design with dual-pawl mechanism for extra strength
- High-polished chrome finish cleans easily
- Ratchet lever is easily accessible for quick direction changes
- Recessed corners in ends provide extra turning power

FLEX-HEAD REVERSIBLE RATCHETING COMBINATION WRENCHES



High Polish Chrome Finish, 12 Point, Metric

Product Code	Size (MM)	A	B	C	D	E
		Overall Length (Inches)	Open End Width (Inches)	Open End Thickness (Inches)	Box End Diameter (Inches)	Box End Thickness (Inches)
JHW1208MRCF	8	5 9/16	23/32	5/32	23/32	9/32
JHW1209MRCF	9	6	13/16	5/32	25/32	5/16
JHW1210MRCF	10	6 5/16	29/32	7/32	27/32	5/16
JHW1211MRCF	11	6 3/4	31/32	7/32	29/32	11/32
JHW1212MRCF	12	7	1 1/32	7/32	31/32	3/8
JHW1213MRCF	13	7 11/16	1 1/16	1/4	1	13/32
JHW1214MRCF	14	7 19/32	1 3/16	1/4	1 3/32	13/32
JHW1215MRCF	15	8	1 1/4	9/32	1 5/32	7/16
JHW1216MRCF	16	8 5/16	1 3/8	9/32	1 7/32	7/16
JHW1217MRCF	17	9	1 15/32	9/32	1 9/32	1/2
JHW1218MRCF	18	9 1/2	1 9/16	5/16	1 3/8	1/2
JHW1219MRCF	19	10	1 9/16	11/32	1 15/32	17/32

JHWMWS-12RCF 12 Piece Reversible Flex-Head Ratcheting Combination Wrench Set, Metric, in Plastic Tray

Contents Include:

Product Code	Size (MM)	Product Code	Size (MM)	Product Code	Size (MM)
JHW1208MRCF	8	JHW1212MRCF	12	JHW1216MRCF	16
JHW1209MRCF	9	JHW1213MRCF	13	JHW1217MRCF	17
JHW1210MRCF	10	JHW1214MRCF	14	JHW1218MRCF	18
JHW1211MRCF	11	JHW1215MRCF	15	JHW1219MRCF	19

Features

- Flex-Head pivots 90° in either direction for access in tight areas
- Fine tooth design with dual-pawl mechanism for extra strength
- High-polished chrome finish cleans easily
- Ratchet lever is easily accessible for quick direction changes
- Recessed corners in ends provide extra turning power



JHW1213MRCF



JHWMWS-12RCF



DOUBLE HEAD OPEN END WRENCHES

Chrome Satin Finish, SAE

Product Code	Size (Inches)	A Overall Length (Inches)	B Open End Width (Inches)	C Open End Thickness (Inches)	D Open End Width (Inches)	E Open End Thickness (Inches)
JHW1020	1/4 x 3/16	4 1/16	9/16	5/32	11/16	3/16
JHW1721	5/16 x 3/8	4 11/16	11/16	5/32	13/16	3/16
JHW1723	3/8 x 7/16	5 5/16	13/16	3/16	15/16	7/32
JHW1725	7/16 x 1/2	5 31/32	3/32	7/32	1 1/16	1/4
JHW1725B	1/2 x 9/16	6 19/32	1 1/16	1/4	1 3/16	9/32
JHW1727	9/16 x 5/8	7 9/32	1 9/16	9/32	1 5/16	9/32
JHW1027B	5/8 x 11/16	7 31/32	1 5/16	5/16	1 7/16	5/16
JHW1729	5/8 x 3/4	8 9/32	1 9/16	9/32	1 9/16	11/32
JHW1729B	11/16 x 3/4	8 21/32	1 7/16	5/16	1 9/16	11/32
JHW1731	3/4 x 13/16	9 11/32	1 9/16	11/32	1 11/16	3/8
JHW1731A	3/4 x 7/8	9 11/16	1 19/32	11/32	1 27/32	3/8
JHW1731B	13/16 x 7/8	10 1/32	1 11/16	3/8	1 13/16	3/8
JHW1033A	7/8 x 15/16	10 3/4	1 19/16	3/8	1 15/16	19/32
JHW1033C	15/16 x 1	11 1/2	1 15/16	13/32	2 1/32	13/32
JHW1037	1 1/16 x 1 1/4	12 15/16	2 3/16	7/16	2 17/32	1/2
JHW1037B	1 1/8 x 1 3/16	13 23/32	2 9/16	15/32	2 7/16	15/32
JHW1038	1 1/4 x 1 9/16	15 9/32	2 9/16	1/2	2 11/16	17/32
JHW1038A	1 3/8 x 1 7/16	16 7/8	2 13/16	17/32	2 15/16	17/32
JHW1039B	1 1/2 x 1 5/8	18 29/32	3 1/16	9/16	3 5/16	19/32

Fed. Spec. ANSI B107.6

JHWS-1705A

5 Piece Double Head Open End Wrench Set, SAE, in Pouch

Contents Include:

Product Code	Size (Inches)	Product Code	Size (Inches)	Product Code	Size (Inches)
JHW1723	3/8 x 7/16	JHW1727	9/16 x 5/8	JHW1731B	13/16 x 7/8
JHW1725B	1/2 x 9/16	JHW1729B	11/16 x 3/4		

JHWS-1710A

10 Piece Double Head Open End Wrench Set, SAE, in Pouch

Contents Include:

Product Code	Size (Inches)	Product Code	Size (Inches)	Product Code	Size (Inches)
JHW1020	1/4 x 3/16	JHW1727	9/16 x 5/8	JHW1037	1 1/16 x 1 1/4
JHW1723	3/8 x 7/16	JHW1729B	11/16 x 3/4	JHW1037B	1 1/8 x 1 3/16
JHW1725	7/16 x 1/2	JHW1731B	13/16 x 7/8		
JHW1725B	1/2 x 9/16	JHW1033C	15/16 x 1		

Features

- Two openings in each wrench with 45° chamfer on wrench ends allow easy placement of wrench on the fastener
- Continuous arc design minimizes spreading and is stronger than "V" design
- Satin chrome finish provides good grip and cleans easily



Made in U.S.A.



JHW1037



JHWS-1705A



JHWS-1710A

DOUBLE OPEN END

WRENCHES





DOUBLE HEAD OPEN END WRENCHES

Chrome Satin Finish, Metric

Product Code	Size (MM)	A Overall Length (Inches)	B Open End Width (Inches)	C Open End Thickness (Inches)	D Open End Width (Inches)	E Open End Thickness (Inches)
JHWEWM-0607	6 x 7	3 13/16	17/32	5/32	19/32	5/32
JHWEWM-0708	7 x 8	4 3/16	19/32	5/32	11/16	3/16
JHWEWM-0910	9 x 10	5	3/4	3/16	27/32	7/32
JHWEWM-1011	10 x 11	5 3/8	27/32	7/32	15/16	7/32
JHWEWM-1213	12 x 13	6 3/16	1	1/4	1 3/32	1/4
JHWEWM-1415	14 x 15	7 1/2	1 1/32	9/32	1 1/4	9/32
JHWEWM-1618	16 x 18	8 3/32	1 5/16	5/16	1 15/32	11/32
JHWEWM-1719	17 x 19	8 17/32	1 13/32	5/16	1 9/16	11/32
JHWEWM-2124	21 x 24	10 17/32	1 23/32	3/8	1 15/16	13/32
JHWEWM-2224	22 x 24	10 3/4	1 13/16	3/8	1 15/16	13/32
JHWEWM-2427	24 x 27	11 29/32	1 15/16	13/32	2 3/16	7/16
JHWEWM-2730	27 x 30	13 5/16	2 3/16	7/16	2 7/16	15/32
JHWEWM3032	30 x 32	14 1/2	2 7/16	15/32	2 9/16	1/2

Fed. Spec. ANSI B107.9M

JHWMWS-26 6 Piece Double Head Open End Wrench Set, Metric, in Pouch

Contents Include:

Product Code	Size (MM)	Product Code	Size (MM)	Product Code	Size (MM)
JHWEWM-0708	7 x 8	JHWEWM-1213	12 x 13	JHWEWM-1618	16 x 18
JHWEWM-1011	10 x 11	JHWEWM-1415	14 x 15	JHWEWM-1719	17 x 19

JHWMWS-31

10 Piece Double Head Open End Wrench Set, Metric, in Pouch

Contents Include:

Product Code	Size (MM)	Product Code	Size (MM)	Product Code	Size (MM)
JHWEWM-0607	6 x 7	JHWEWM-1415	14 x 15	JHWEWM-2427	24 x 27
JHWEWM-0708	7 x 8	JHWEWM-1618	16 x 18	JHWEWM-2730	27 x 30
JHWEWM-1011	10 x 11	JHWEWM-1719	17 x 19		
JHWEWM-1213	12 x 13	JHWEWM-2124	21 x 24		

Features

- Two openings in each wrench with 45° chamfer on wrench ends allow easy placement of wrench on the fastener
- Continuous arc design minimizes spreading and is stronger than "V" design
- Satin chrome finish provides good grip and cleans easily



Made in U.S.A.

SHORT DOUBLE HEAD OPEN END WRENCHES



Chrome Satin Finish, SAE

Product Code	Size (Inches)	A Overall Length (Inches)	B Open End Width (Inches)	C Open End Thickness (Inches)	D Open End Width (Inches)	E Open End Thickness (Inches)
JHWOES-0607	3/16 x 7/32	2 27/32	13/32	1/8	15/32	1/8
JHWOES-0809	1/4 x 9/32	3 5/32	1/2	1/8	9/16	1/8
JHWOES-1011	5/16 x 11/32	3 7/16	5/8	5/32	11/16	1/8
JHWOES-1214	3/8 x 7/16	3 3/4	3/4	5/32	29/32	1/8
JHWOES-1618	1/2 x 9/16	4 11/32	1	3/16	1 1/8	3/16

Fed. Spec. ANSI B107.6

JHWS-1605

5 Piece Short Double Head Open End Wrench Set, SAE, in Pouch

Contents Include:

Product Code	Size (Inches)	Product Code	Size (Inches)	Product Code	Size (Inches)
JHWOES-0607	3/16 x 7/32	JHWOES-1011	5/16 x 11/32	JHWOES-1618	1/2 x 9/16
JHWOES-0809	1/4 x 9/32	JHWOES-1214	3/8 x 7/16		

Features

- Two openings in each wrench with 45° chamfer on wrench ends allow easy placement of wrench on the fastener
- Continuous arc design minimizes spreading and is stronger than "V" design
- Satin chrome finish provides good grip and cleans easily



Made in U.S.A.



JHWEWM-1618



JHWMWS-26



JHWMWS-31



JHWOES-1011



JHWS-1605

MINIATURE 15° × 80° DOUBLE HEAD OPEN END WRENCHES

Satin Chrome Finish, SAE

Product Code	Size (Inches)	Overall Length (Inches)	Open End Width (Inches)	Open End Thickness (Inches)	Open End Width (Inches)	Open End Thickness (Inches)
JHW1112A	3/16	3	1/2	7/64	1/2	7/64
JHW1113A	13/64	3	1/2	7/64	1/2	7/64
JHW1114A	7/32	3	1/2	7/64	1/2	7/64
JHW1115A	15/64	3	1/2	7/64	1/2	7/64
JHW1116A	1/4	3	1/2	7/64	1/2	7/64
JHW1118A	9/32	3 1/2	5/8	9/64	5/8	9/64
JHW1120A	5/16	3 1/2	5/8	9/64	5/8	9/64
JHW1122A	11/32	3 3/4	3/4	9/64	3/4	9/64
JHW1124A	3/8	3 3/4	3/4	9/64	3/4	9/64
JHW1128A	7/16	4 7/16	7/16	11/64	7/16	11/64
JHW1132A	1/2	4 7/16	7/16	11/64	7/16	11/64
JHW1136A	9/16	5 3/4	1 5/32	13/64	1 5/32	13/64
JHW1140A	5/8	5 3/4	1 5/32	13/64	1 5/32	13/64

Features

- Wrench heads are offset at 15° and 80° to the handle
- Both ends are the same size to permit the wrench to be used in four different positions
- 45° chamfer on wrench ends allow easy placement of wrench on the fastener
- Continuous arc design minimizes spreading and is stronger than "V" design
- Thin head is perfect for tight clearances
- Satin finish provides corrosion resistance and slip resistant grip
- Excellent for fast turning of fasteners in limited clearance areas
- Each wrench has the same size opening at both ends

JHWWS-1108SP 8 Piece Mini Double Open End Wrench & Plier Set, SAE, in Pouch

Contents Include:

Product Code	Size (Inches)	Product Code	Size (Inches)	Product Code	Size (Inches)
JHW1114A	7/32	JHW1118A	9/32	JHW1124A	3/8
JHW1115A	15/64	JHW1120A	5/16	JHW1128A	7/16
JHW1116A	1/4	JHW1122A	11/32		

JHWWS-1113CA 10 Piece Mini Double Open End Wrench & Plier Set, SAE, in Pouch

Contents Include:

Product Code	Size (Inches)	Product Code	Size (Inches)	Product Code	Size (Inches)
JHW1112A	3/16	JHW1116A	1/4	JHW1124A	3/8
JHW1113A	13/64	JHW1118A	9/32	JHWPL-1519C	5" SUPERJOINT® Utility Pliers
JHW1114A	7/32	JHW1120A	5/16		
JHW1115A	15/64	JHW1122A	11/32		

JHWWS1142PCA 14 Piece Mini Double Open End Wrench & Plier Set, SAE, in Pouch

Contents Include:

Product Code	Size (Inches)	Product Code	Size (Inches)	Product Code	Size (Inches)
JHW1112A	3/16	JHW1118A	9/32	JHW1132A	1/2
JHW1113A	13/64	JHW1120A	5/16	JHW1136A	9/16
JHW1114A	7/32	JHW1122A	11/32	JHW1140A	5/8
JHW1115A	15/64	JHW1124A	3/8	JHWPL-1519C	5" SUPERJOINT® Utility Pliers
JHW1116A	1/4	JHW1128A	7/16		



JHW1128A



JHWWS-1108SP



JHWWS-1113CA



JHWWS1142PCA



MINIATURE 15° × 80° DOUBLE HEAD OPEN END WRENCHES

Satin Chrome Finish, Metric



JHW1111MM

Product Code	Size (MM)	Overall Length (Inches)	Open End Width (Inches)	Open End Thickness (Inches)	Open End Width (Inches)	Open End Thickness (Inches)
JHW1104MM	4	3	1/2	7/64	1/2	7/64
JHW1105MM	5	3	1/2	7/64	1/2	7/64
JHW1105.5MM	5.5	3	1/2	7/64	1/2	7/64
JHW1106MM	6	3	1/2	7/64	1/2	7/64
JHW1107MM	7	3 1/2	5/8	9/64	5/8	9/64
JHW1108MM	8	3 1/2	5/8	9/64	5/8	9/64
JHW1109MM	9	3 3/4	3/4	9/64	3/4	9/64
JHW1110MM	10	4 7/16	7/16	11/64	7/16	11/64
JHW1111MM	11	4 7/16	7/16	11/64	7/16	11/64
JHW1112MM	12	4 7/16	7/16	11/64	7/16	11/64
JHW1113MM	13	4 7/16	7/16	11/64	7/16	11/64
JHW1114MM	14	5 3/4	1 5/32	13/64	1 5/32	13/64
JHW1115MM	15	5 3/4	1 5/32	13/64	1 5/32	13/64
JHW1116MM	16	5 3/4	1 5/32	13/64	1 5/32	13/64

Features

- Wrench heads are offset at 15° and 80° to the handle
- Both ends are the same size to permit the wrench to be used in four different positions
- 45° chamfer on wrench ends allow easy placement of wrench on the fastener
- Continuous arc design minimizes spreading and is stronger than "V" design
- Thin head is perfect for tight clearances
- Satin finish provides corrosion resistance and slip resistant grip

JHWMWS-1110

10 Piece Mini Double Open End Wrench & Plier Set, Metric, in Pouch

Contents Include:

Product Code	Size (MM)	Product Code	Size (MM)	Product Code	Size (MM)
JHW1104MM	4	JHW1107MM	7	JHW1111MM	11
JHW1105MM	5	JHW1108MM	8	JHWPL-1519C	5" SUPERJOINT Utility Pliers
JHW1105.5MM	5.5	JHW1109MM	9		
JHW1106MM	6	JHW1110MM	10		



JHWMWS-1110

JHWMWS-1115

15 Piece Mini Double Open End Wrench & Plier Set, Metric, in Pouch

Contents Include:

Product Code	Size (MM)	Product Code	Size (MM)	Product Code	Size (MM)
JHW1104MM	4	JHW1108MM	8	JHW1113MM	13
JHW1105MM	5	JHW1109MM	9	JHW1114MM	14
JHW1105.5MM	5.5	JHW1110MM	10	JHW1115MM	15
JHW1106MM	6	JHW1111MM	11	JHW1116MM	16
JHW1107MM	7	JHW1112MM	12	JHWPL-1519C	5" SUPERJOINT Utility Pliers



JHWMWS-1115



DOUBLE OPEN END

WRENCHES

15° - 60° DOUBLE OPEN END ANGLE-HEAD WRENCHES

Chrome Satin Finish, SAE

Product Code	Size (Inches)	A Head Diameter (Inches)	B Head Thickness (Inches)	C Overall Length (Inches)
JHW3712	3/8	25/32	7/32	4 3/4
JHW3714	7/16	7/8	7/32	5
JHW3716	1/2	1	7/32	5 1/2
JHW3718	9/16	1 1/8	1/4	6
JHW3720	5/8	1 3/16	9/32	6 1/4
JHW3722	11/16	1 5/16	9/32	7
JHW3724	3/4	1 7/16	9/32	7 1/4
JHW3726	13/16	1 19/32	9/32	7 1/2
JHW3728	7/8	1 21/32	9/32	8 1/4
JHW3730	15/16	1 25/32	5/16	9 1/16
JHW3732	1	1 15/16	9/16	9 3/4
JHW3734	1 1/16	2 1/16	5/16	10
JHW3736	1 1/8	2 1/4	9/16	11
JHW3740	1 1/4	2 3/8	11/32	11 1/2
JHW3744	1 3/8	2 11/16	13/32	12 1/2
JHW3746	1 7/16	2 11/16	13/32	12 1/2
JHW3748	1 1/2	2 11/16	13/32	12 1/2
JHW3752	1 5/8	3 13/64	13/32	15 3/4
JHW3754	1 11/16	3 11/32	1/2	16 1/2
JHW3756	1 3/4	3 7/16	17/32	17
JHW3758	1 13/16	3 9/16	17/32	17 3/4
JHW3760	1 7/8	3 11/16	9/16	18 1/2
JHW3764	2	3 15/16	13/32	19 1/4

Fed. Spec. ANSI B107.39 Type 2 Class 3



JHW3732



JHW3780

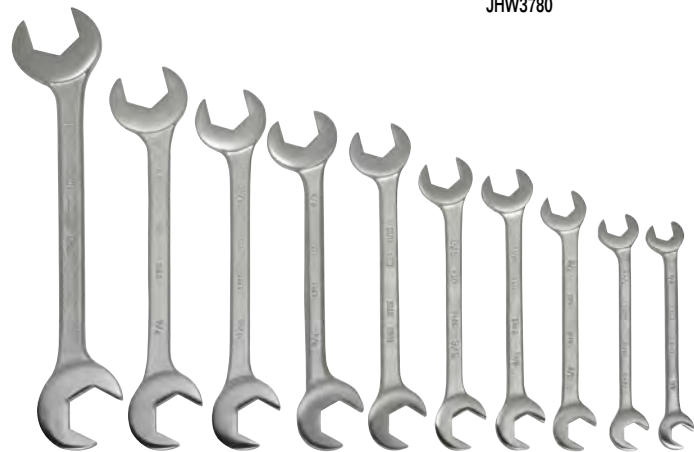

JHW3782

JHW3780 5 Piece Double Open End Wrench Set, SAE, in Pouch

Contents Include:

Product Code	Size (Inches)	Product Code	Size (Inches)
JHW3712	3/8	JHW3718	9/16
JHW3714	7/16	JHW3720	5/8
JHW3716	1/2		

JHW3782 10 Piece Double Open End Wrench Set, SAE, in Pouch

Contents Include:

Product Code	Size (Inches)	Product Code	Size (Inches)
JHW3712	3/8	JHW3722	11/16
JHW3714	7/16	JHW3724	3/4
JHW3716	1/2	JHW3726	13/16
JHW3718	9/16	JHW3728	7/8
JHW3720	5/8	JHW3732	1

Features

- Wrench heads are offset at 15° and 60° to the handle
- Both ends are the same size to permit the wrench to be used in four different positions
- 45° chamfer on wrench ends allow easy placement of wrench on the fastener
- Continuous arc design minimizes spreading and is stronger than "V" design
- Thin head is perfect for tight clearances
- Satin chrome finish provides good grip and cleans easily



DOUBLE OPEN END

WRENCHES





DOUBLE HEAD FLARE NUT WRENCHES

Chrome Satin Finish, 6 Point, SAE

Product Code	Size (Inches)	A	B	C	D	E
		Overall Length (Inches)	Open End Dia (Inches)	Open End Thickness (Inches)	Open End Dia (Inches)	Open End Thickness (Inches)
JHW10600	3/8 x 7/16	6	27/32	11/32	15/16	11/32
JHW10602	1/2 x 9/16	6 3/4	15/16	13/32	1	13/32
JHW10604	5/8 x 11/16	7 3/4	1 3/32	7/16	1 3/16	15/32
JHW10606	3/4 x 7/8	8 5/8	1 9/32	1/2	1 13/32	17/32

Fed. Spec.: ANSI B107.6

JHW11690

4 Piece Double Head Flare Nut Wrench Set, 6 Point, SAE, in Pouch

Contents Include:

Product Code	Size (Inches)	Product Code	Size (Inches)
JHW10600	3/8 x 7/16	JHW10604	5/8 x 11/16
JHW10602	1/2 x 9/16	JHW10606	3/4 x 7/8

JHW11691 3 Piece Double Head Flare Nut Wrench Set, 6 Point, SAE, in Pouch

Contents Include:

Product Code	Size (Inches)	Product Code	Size (Inches)
JHW10600	3/8 x 7/16	JHW10604	5/8 x 11/16
JHW10602	1/2 x 9/16		

Features

- Will not mar fittings on pipes and tubing
- Satin chrome textured finish provides great feel and extra gripping power
- Recessed corners in ends provide extra turning power



JHW10600



JHW11690



JHW11691

DOUBLE OPEN END

WRENCHES



30° SERVICE WRENCHES

Satin Chrome Finish, SAE

Product Code	Size (Inches)	Overall Length (Inches)	Head Diameter (Inches)	Head Thickness (Inches)
JHW3524	3/4	6 1/4	1 11/16	1/4
JHW3526	13/16	6 1/4	1 11/16	1/4
JHW3528	7/8	6 1/4	1 11/16	1/4
JHW3530	15/16	6 7/8	1 7/8	1/4
JHW3532	1	6 7/8	1 7/8	1/4
JHW3534	1 1/16	6 7/8	1 7/8	1/4
JHW3536	1 1/8	7	2 1/16	1/4
JHW3538	1 3/16	7	2 1/16	1/4
JHW3540	1 1/4	7	2 1/16	1/4
JHW3542	1 5/16	7 5/8	2 1/2	9/32
JHW3544	1 3/8	7 5/8	2 1/2	9/32
JHW3546	1 7/16	7 5/8	2 1/2	9/32
JHW3548	1 1/2	7 5/8	2 1/2	9/32
JHW3550	1 9/16	7 5/8	2 5/8	9/32
JHW3552	1 3/8	7 5/8	2 5/8	9/32
JHW3554	1 11/16	7 5/8	2 5/8	9/32
JHW3556	1 3/4	8 1/2	3 1/8	5/16
JHW3558	1 13/16	8 1/2	3 1/8	5/16
JHW3560	1 7/8	8 1/2	3 1/8	5/16
JHW3562	1 15/16	8 1/2	3 1/8	5/16
JHW3564	2	8 1/2	3 1/2	5/16
JHW3568	2 1/8	8 1/2	3 1/2	5/16
JHW3572	2 1/4	8 1/2	3 1/2	5/16
JHW3576	2 3/8	9 1/2	3 1/2	5/16

Fed. Spec: GGG-W-636E Type 17 Class 3



JHW3542



JHWWS-3510

JHWWS-3510 10 Piece Service Wrench Set, SAE in Pouch

Contents Include:

Product Code	Size (Inches)	Product Code	Size (Inches)	Product Code	Size (Inches)
JHW3524	3/4	JHW3532	1	JHW3538	1 3/16
JHW3526	13/16	JHW3534	1 1/16	JHW3540	1 1/4
JHW3528	7/8	JHW3536	1 1/8	JHW3544	1 3/8
JHW3530	15/16				

30° SERVICE WRENCHES

Satin Chrome Finish, Metric



Product Code	Size (MM)	Overall Length (Inches)	Head Diameter (Inches)	Head Thickness (Inches)
JHW3519M	19	6 1/4	1 11/16	1/4
JHW3521M	21	6 1/4	1 11/16	1/4
JHW3522M	22	6 1/4	1 11/16	1/4
JHW3524M	24	6 7/8	1 7/8	1/4
JHW3527M	27	6 7/8	1 7/8	1/4
JHW3530M	30	7	2 1/16	1/4
JHW3532M	32	7	2 1/16	1/4
JHW3536M	36	7 5/8	2 1/2	9/32
JHW3537M	37	7 5/8	2 1/2	9/32
JHW3538M	38	7 5/8	2 1/2	9/32
JHW3540M	40	7 5/8	2 5/8	9/32
JHW3541M	41	7 5/8	2 5/8	9/32
JHW3542M	42	7 5/8	2 5/8	9/32
JHW3544M	44	7 5/8	2 5/8	9/32
JHW3546M	46	8 1/2	3 1/8	5/16
JHW3548M	48	8 1/2	3 1/8	5/16
JHW3550M	50	8 1/2	3 1/8	5/16
JHW3552M	52	8 1/2	3 1/2	5/16
JHW3555M	55	8 1/2	3 1/2	5/16
JHW3560M	60	9 1/2	3 1/2	5/16
JHW3565M	65	9 1/2	3 1/2	5/16

Fed. Spec: GGG-W-636E Type 17 Class 3



JHW3537M



JHWMWS-3510

JHWMWS-3510 10 Piece Service Wrench Set, Metric in Pouch

Contents Include:

Product Code	Size (MM)	Product Code	Size (MM)	Product Code	Size (MM)
JHW3519M	19	JHW3527M	27	JHW3536M	36
JHW3521M	21	JHW3530M	30	JHW3538M	38
JHW3522M	22	JHW3532M	32	JHW3540M	40
JHW3524M	24				

Features

- Ultra thin pattern for use on jam nuts and access to confined areas
- 30° offset head
- Satin chrome finish



Made in U.S.A.



DOUBLE HEAD 10° OFFSET BOX END WRENCHES



Chrome Satin Finish, 12 Point, SAE

Product Code	Size (Inches)	A Overall Length (Inches)	B Box End Diameter (Inches)	C Box End Thickness (Inches)	D Box End Diameter (Inches)	E Box End Thickness (Inches)
JHW7723	3/8 x 7/16	7 5/8	19/32	5/16	21/32	11/32
JHW7725B	1/2 x 9/16	8 11/16	3/4	3/8	27/32	3/8
JHW7727A	5/8 x 11/16	10 5/32	29/32	7/16	1	15/32
JHW7029B	11/16 x 3/4	10 15/16	1	15/32	1 3/32	1/2
JHW7731A	3/4 x 7/8	12 1/32	1 3/32	1/2	1 1/4	9/16
JHW7731B	13/16 x 7/8	12 13/32	1 3/16	17/32	1 1/4	9/16
JHW7033C	15/16 x 1	14 1/8	1 11/32	19/32	1 7/16	5/8
JHW7038	1 1/8 x 1 1/16	16 3/32	1 19/32	11/16	1 11/16	11/16
JHW7039B	1 1/4 x 1 5/16	17 5/8	1 25/32	23/32	1 27/32	3/4

Fed. Spec. ANSI B107.6

JHWS-7707

7 Piece Double Head 10° Offset Box End Wrench Set, SAE, in Pouch

Contents Include:

Product Code	Size (Inches)	Product Code	Size (Inches)	Product Code	Size (Inches)
JHW7723	3/8 x 7/16	JHW7029B	11/16 x 3/4	JHW7033C	15/16 x 1
JHW7725B	1/2 x 9/16	JHW7731A	3/4 x 7/8		
JHW7727A	5/8 x 11/16	JHW7731B	13/16 x 7/8		

Features

- SUPERTORQUE™ box opening design allows application of higher torque without rounding or deforming hex fastener points
- No contact is made at the corners
- Instead, wrenching forces are placed on the flat surfaces behind the points
- 10° offset box end allows clearance in tight areas
- Sizes are clearly marked on handle ends



Made in U.S.A.

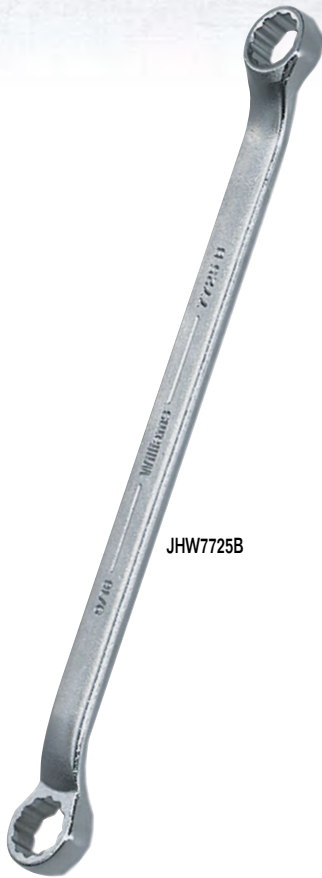

JHW7725B



JHWS-7707

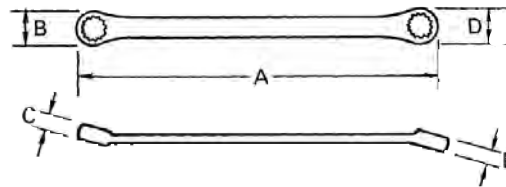

DOUBLE BOX END

WRENCHES

DOUBLE HEAD 10° OFFSET BOX END WRENCHES



Chrome Satin Finish, 12 Point, Metric

Product Code	Size (MM)	A Overall Length (Inches)	B Box End Diameter (Inches)	C Box End Thickness (Inches)	D Box End Diameter (Inches)	E Box End Thickness (Inches)
JHWBWM-0810	8 x 10	7 5/16	1/2	9/32	19/32	5/16
JHWBWM-1011	10 x 11	7 31/32	19/32	5/16	21/32	11/32
JHWBWM-1012	10 x 12	8 3/16	19/32	5/16	23/32	11/32
JHWBWM-1113	11 x 13	8 5/8	21/32	11/32	25/32	3/8
JHWBWM-1213	12 x 13	8 27/32	25/32	11/32	25/32	3/8
JHWBWM-1214	12 x 14	9 1/16	23/32	11/32	13/16	13/32
JHWBWM-1315	13 x 15	9 1/2	25/32	3/8	7/8	13/32
JHWBWM-1415	14 x 15	9 3/4	13/16	13/32	7/8	13/32
JHWBWM-1417	14 x 17	9 29/32	13/16	13/32	31/32	15/32
JHWBWM-1618	16 x 18	10 27/32	15/16	7/16	1 1/32	15/32
JHWBWM-1719	17 x 19	11 9/32	31/32	15/32	1 3/32	1/2
JHWBWM-1821	18 x 21	11 19/16	1 3/32	15/32	1 3/16	17/32
JHWBWM-1922	19 x 22	12 3/8	1 3/32	1/2	1 1/4	9/16
JHWBWM-2124	21 x 24	13 1/4	1 3/16	17/32	1 11/32	19/32
JHWBWM-2224	22 x 24	13 19/32	1 1/4	9/16	1 11/32	19/32
JHWBWM-2427	24 x 27	14 19/32	1 11/32	19/32	1 17/32	21/32
JHWBWM-2730	27 x 30	15 29/32	1 17/32	21/32	1 11/16	11/16
JHWBWM-3032	30 x 32	17 1/32	1 11/16	11/16	1 25/32	23/32

Fed. Spec. ANSI B107.9M

JHWMWS-BWM10 10 Piece Double Head 10° Offset Box End Wrench Set, Metric, in Pouch

Contents Include:

Product Code	Size (MM)	Product Code	Size (MM)	Product Code	Size (MM)
JHWBWM-0810	8 x 10	JHWBWM-1618	16 x 18	JHWBWM-2730	27 x 30
JHWBWM-1113	11 x 13	JHWBWM-1719	17 x 19	JHWBWM-3032	30 x 32
JHWBWM-1214	12 x 14	JHWBWM-1922	19 x 22		
JHWBWM-1415	14 x 15	JHWBWM-2124	21 x 24		

JHWMWS-BWM12 12 Piece Double Head 10° Offset Box End Wrench Set, Metric, in Pouch

Contents Include:

Product Code	Size (MM)	Product Code	Size (MM)	Product Code	Size (MM)
JHWBWM-1011	10 x 11	JHWBWM-1417	14 x 17	JHWBWM-1922	19 x 22
JHWBWM-1214	12 x 14	JHWBWM-1618	16 x 18	JHWBWM-2224	22 x 24
JHWBWM-1315	13 x 15	JHWBWM-1719	17 x 19	JHWBWM-2730	27 x 30
JHWBWM-1415	14 x 15	JHWBWM-1821	18 x 21	JHWBWM-3032	30 x 32

Features

- SUPERTORQUE™ box opening design allows application of higher torque without rounding or deforming hex fastener points
- No contact is made at the corners
- Instead, wrenching forces are placed on the flat surfaces behind the points
- 10° offset box end allows clearance in tight areas
- Sizes are clearly marked on handle ends

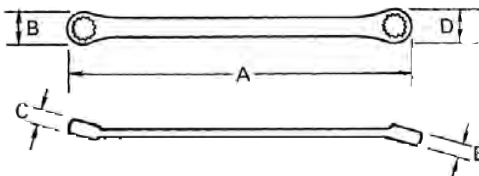

JHWBWM-1012



JHWMWS-BWM10



JHWMWS-BWM12





DOUBLE HEAD 60° OFFSET BOX END WRENCHES

Chrome Satin Finish, 12 Point, SAE



JHW8725B

Product Code	Size (Inches)	A Overall Length (Inches)	B Box End Diameter (Inches)	C Box End Thickness (Inches)	D Box End Diameter (Inches)	E Box End Thickness (Inches)
JHW8720	1/4 x 5/16	6 7/16	13/32	1/4	15/32	9/32
JHW8723	3/8 x 7/16	7 5/8	9/16	5/16	21/32	5/16
JHW8725	7/16 x 1/2	8 3/16	21/32	11/32	3/4	11/32
JHW8725B	1/2 x 9/16	8 25/32	3/4	3/8	27/32	3/8
JHW8727	9/16 x 5/8	9 3/8	27/32	19/32	29/32	19/32
JHW8727A	5/8 x 11/16	9 31/32	29/32	7/16	1	7/16
JHW8729	5/8 x 3/4	10 1/4	15/16	7/16	1 3/32	7/16
JHW8729A	11/16 x 13/16	10 27/32	1	19/32	1 3/16	19/32
JHW8731A	3/4 x 7/8	11 7/16	1 3/32	17/32	1 9/32	17/32
JHW8033A	7/8 x 19/16	13	1 9/32	9/16	1 3/8	9/16
JHW8033C	15/16 x 1	13 31/32	1 3/8	19/32	1 7/16	19/32

Fed. Spec. ANSI B107.6

JHWS-8707

7 Piece Double Head 60° Offset Box End Wrench Set, SAE, in Pouch

Contents Include:

Product Code	Size (Inches)	Product Code	Size (Inches)	Product Code	Size (Inches)
JHW8720	1/4 x 5/16	JHW8729	5/8 x 3/4	JHW8033C	15/16 x 1
JHW8723	3/8 x 7/16	JHW8729A	11/16 x 13/16		
JHW8725B	1/2 x 9/16	JHW8731A	3/4 x 7/8		



JHWS-8707

Features

- SUPERTORQUE™ box opening design allows application of higher torque without rounding or deforming hex fastener points
- No contact is made at the corners
- Instead, wrenching forces are placed on the flat surfaces behind the points
- 60° offset box end allows extra knuckle and bolt clearance in tight areas
- Sizes are clearly marked on handle ends



Made in U.S.A.

DOUBLE BOX END/RATCHETING BOX END

WRENCHES



SINGLE HEAD RATCHETING BOX WRENCHES

High Polish Chrome Finish, 12 Point, SAE



JHWRB-52

Product Code	Size (Inches)	A Overall Length (Inches)	Product Code	Size (Inches)	A Overall Length (Inches)
JHWRB-42	1 5/16	15 1/2	JHWRB-54	1 11/16	19
JHWRB-44	1 3/8	15 1/2	JHWRB-56	1 3/4	19
JHWRB-46	1 7/16	15 1/2	JHWRB-58	1 13/16	19
JHWRB-48	1 1/2	15 1/2	JHWRB-60	1 7/8	19
JHWRB-50	1 9/16	15 1/2	JHWRB-64	2	19
JHWRB-52	1 5/8	15 1/2	JHWRB-68	2 1/8	19

Features

- Combines the quick ratcheting action with opening sizes large enough to handle most industrial applications
- Requires less effort than a conventional combination wrench
- All wrenches contain 12-point Torque Grip® wheels
- Ideal for long "bolt-through" applications
- Turn wrench over to change direction



Made in U.S.A.

SINGLE HEAD RATCHETING BOX WRENCHES



High Polish Chrome Finish, 12 Point, Metric

Product Code	Size (MM)	A Overall Length (Inches)	Product Code	Size (MM)	A Overall Length (Inches)
JHWRBM-22	22	12	JHWRBM-27	27	12
JHWRBM-23	23	12	JHWRBM-29	29	12
JHWRBM-24	24	12	JHWRBM-30	30	12
JHWRBM-25	25	12	JHWRBM-32	32	15 1/2
JHWRBM-26	26	12	JHWRBM-36	36	15 1/2

Features

- Combines the quick ratcheting action with opening sizes large enough to handle most industrial applications
- Requires less effort than a conventional combination wrench
- All wrenches contain 12-point Torque Grip® wheels
- Ideal for long "bolt-through" applications
- Turn wrench over to change direction



Made in U.S.A.



JHWRBM-22

RATCHETING BOX END

WRENCHES

DOUBLE HEAD RATCHETING BOX WRENCHES



High Polish Chrome Finish, 6 & 12 Point, SAE

Product Code	Number of Points	Size (Inches)	A Overall Length (Inches)	B Box End Diameter (Inches)	C Box End Thickness (Inches)	D Box End Diameter (Inches)	E Box End Thickness (Inches)
JHWRB-810	6	1/4 x 5/16	4 1/4	19/32	3/8	1 1/16	3/8
JHWRB-1214	6	3/8 x 7/16	5 1/2	29/32	3/8	7/8	3/8
JHWRB-1618	6	1/2 x 9/16	6 3/4	1	1/2	1 5/32	1/2
JHWRB-1820	12	5/16 x 3/8	8 1/8	1 5/16	1/2	1 7/16	1/2
JHWRB-2022	12	5/8 x 1 1/16	8 1/8	1 5/16	1/2	1 7/16	1/2
JHWRB-2024	12	5/8 x 3/4	8 1/8	1 5/16	1/2	1 7/16	1/2
JHWRB-2428	12	3/4 x 7/8	9 1/4	1 13/32	1/2	1 9/16	1/2
JHWRB-3036	12	19/16 x 1 1/8	15 1/8	1 21/32	9/16	2 5/32	9/16
JHWRB-3440	12	1 1/16 x 1 1/4	15 1/8	1 29/32	9/16	2 5/32	9/16



JHWRB-1618

JHWS-12

5 Piece Ratcheting Box Wrench Set, 6 & 12 Point, SAE, in Pouch

Contents Include:

Product Code	Size (Inches)	Product Code	Size (Inches)	Product Code	Size (Inches)
JHWRB-810	1/4 x 5/16	JHWRB-1618	1/2 x 9/16	JHWRB-2428	3/4 x 7/8
JHWRB-1214	3/8 x 7/16	JHWRB-2022	5/8 x 1 1/16		

Features

- Allows fast removal of fasteners with a ratcheting action at each end
- Ideal for long "bolt-through" applications
- Flat handle allows access to tight clearance areas
- Turn wrench over to change direction



Made in U.S.A.

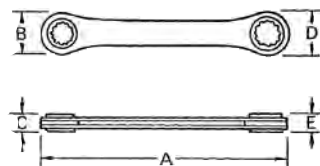

JHWS-12



JHWRBM-1314



JHWMWS-30

DOUBLE HEAD RATCHETING BOX WRENCHES



High Polish Chrome Finish, 6 & 12 Point, Metric

Product Code	Number of Points	Size (MM)	A	B	C	D	E
			Overall Length (Inches)	Box End Diameter (Inches)	Box End Thickness (Inches)	Box End Diameter (Inches)	Box End Thickness (Inches)
JHWRBM-0708	6	7 x 8	4 1/2	1 1/16	3/8	1 1/32	3/8
JHWRBM-0910	6	9 x 10	5 1/2	7/8	3/8	7/8	3/8
JHWRBM-1112	6	11 x 12	6 7/8	1 3/16	1/2	1 1/8	1/2
JHWRBM-1314	6	13 x 14	6 7/8	1 3/16	1/2	1 1/8	1/2
JHWRBM-1517	12	15 x 17	8 1/8	1 7/16	1/2	1 7/16	1/2
JHWRBM-1618	12	16 x 18	8 1/8	1 7/16	1/2	1 7/16	1/2
JHWRBM-1921	12	19 x 21	9 1/4	1 9/16	1/2	1 9/16	1/2

JHWMWS-30

5 Piece Ratcheting Box Wrench Set, 6 & 12 Point, Metric, in Pouch

Contents Include:

Product Code	Size (MM)	Product Code	Size (MM)	Product Code	Size (MM)
JHWRBM-0708	7 x 8	JHWRBM-1112	11 x 12	JHWRBM-1517	15 x 17
JHWRBM-0910	9 x 10	JHWRBM-1314	13 x 14		

Features

- Allows fast removal of fasteners with a ratcheting action at each end
- Ideal for long "bolt-through" applications
- Flat handle allows access to tight clearance areas
- Turn wrench over to change direction

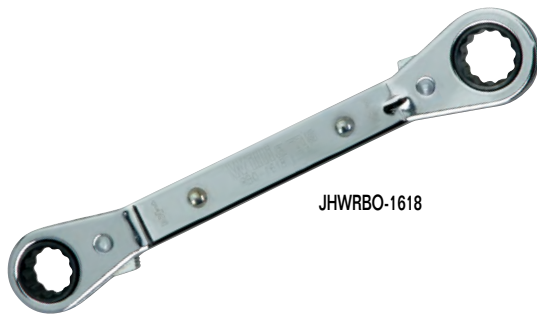

JHWRBO-1618



JHWS-5

DOUBLE HEAD 25° REVERSIBLE OFFSET RATCHETING BOX WRENCHES



High Polish Chrome Finish, 12 Point, SAE

Product Code	Size (Inches)	A	B	C	D	E
		Overall Length (Inches)	Box End Diameter (Inches)	Box End Thickness (Inches)	Box End Diameter (Inches)	Box End Thickness (Inches)
JHWRBO-810	1/4 x 5/16	4 1/4	19/32	3/8	2 1/32	3/8
JHWRBO-1214	3/8 x 7/16	5 7/16	27/32	3/8	7/8	3/8
JHWRBO-1618	1/2 x 9/16	6 3/4	1	1/2	1 1/32	1/2
JHWRBO-2022	5/8 x 1 1/16	8	1 1/16	1/2	1 7/16	1/2
JHWRBO-2024	5/8 x 3/4	8	1 9/16	1/2	1 7/16	1/2
JHWRBO-2226	1 1/16 x 13/16	9 1/8	1 13/32	1/2	1 9/16	1/2
JHWRBO-2428	3/4 x 7/8	9 1/8	1 13/32	1/2	1 9/16	1/2
JHWRBO-2630	13/16 x 15/16	9 1/8	1 13/32	1/2	1 9/16	1/2

JHWS-5

5 Piece Reversible Offset Ratcheting Box Wrench Set, 12 Point, SAE, in Pouch

Contents Include:

Product Code	Size (Inches)	Product Code	Size (Inches)	Product Code	Size (Inches)
JHWRBO-810	1/4 x 5/16	JHWRBO-1618	1/2 x 9/16	JHWRBO-2428	3/4 x 7/8
JHWRBO-1214	3/8 x 7/16	JHWRBO-2022	5/8 x 1 1/16		

Features

- 25° offset handle clears obstructions that flat handle wrenches cannot
- Allows fast removal of fasteners with a ratcheting action at each end
- Ideal for long "bolt-through" applications

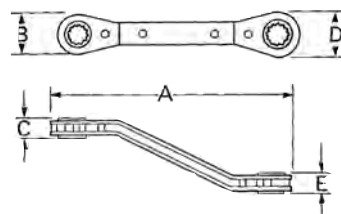



RATCHETING FLARE NUT WRENCHES

Black Industrial Finish, 12 Point, SAE

Product Code	Size (Inches)	Overall Length (Inches)	Head Diameter (Inches)	Head Thickness (Inches)
JHWRFW-12	3/8	5 3/8	1	5/16
JHWRFW-14	7/16	5 3/8	1	5/16
JHWRFW-16	1/2	5 3/8	1	5/16
JHWRFW-18	9/16	7 1/4	1 1/32	3/8
JHWRFW-20	5/8	7 1/4	1 1/32	3/8
JHWRFW-22	11/16	7 1/4	1 1/32	3/8
JHWRFW-24	3/4	7 1/4	1 1/32	3/8
JHWRFW-26	13/16	9 5/16	1 5/8	1/2
JHWRFW-28	7/8	9 5/16	1 5/8	1/2
JHWRFW-30	15/16	9 5/16	1 5/8	1/2
JHWRFW-32	1	9 5/16	1 5/8	1/2

Features

- Designed for use on 6 and 12 point tube fittings, fasteners, valves and compression fittings
- Unique design requires only 30° rotation for ratcheting action
- High carbon steel jaws snap open, then close around fastener with 6 point contact
- Prevents distortion of thin-walled fitting
- Allow easy access to tight locations



JHWRFW-24

FLARE NUT

WRENCHES



DOUBLE HEAD FLARE NUT WRENCHES

Chrome Satin Finish, 6 Point, SAE

Product Code	Size (Inches)	A Overall Length (Inches)	B Open End Dia (Inches)	C Open End Thickness (Inches)	D Open End Dia (Inches)	E Open End Thickness (Inches)
JHWXFN-0810	1/4 x 5/16	4 27/32	19/32	1/4	5/8	9/32
JHWXFN-1214	3/8 x 7/16	5 13/16	25/32	5/16	27/32	11/32
JHWXFN-1618	1/2 x 9/16	6 13/16	15/16	3/8	1	13/32
JHWXFN-2022	5/8 x 11/16	7 3/4	1 3/32	7/16	3/16	15/32
JHWXFN-2432	3/4 x 1	9 1/2	1 1/4	1/2	19/32	5/8
JHWXFN-2836	7/8 x 1 1/8	10.5	1 7/16	9/16	1 3/4	11/16

Fed. Spec.: ANSI B107.6

JHWWS-14

5 Piece Double Head Flare Nut Wrench Set, 6 Point, SAE, in Pouch

Contents Include:

Product Code	Size (Inches)	Product Code	Size (Inches)	Product Code	Size (Inches)
JHWXFN-1214	3/8 x 7/16	JHWXFN-2022	5/8 x 11/16	JHWXFN-2836	7/8 x 1 1/8
JHWXFN-1618	1/2 x 9/16	JHWXFN-2432	3/4 x 1		

Features

- Will not mar fittings on pipes and tubing
- Satin chrome textured finish provides great feel and extra gripping power
- Recessed corners in ends provide extra turning power



JHWXFN-1618



JHWWS-14





33HRUS

BAHCO® ADJUSTABLE WRENCH WITH VALVE PERSUADER

Product Code	Length (Inches)	Maximum Jaw Opening (Inches)	Valve Wheel Wrench Opening
33HRUS	10	1 3/4	3/4

Features

- Two tools combined into one convenient operator's tool that can be used wherever valves are adjusted for flow and pressure
- 10" overall length supplies leverage while being compact enough to be easily carried.
- Big-mouth adjustable wrench has large, 1 3/4" capacity
- 3/4" valve wheel wrench opening.
- Precision hardened and anti-corrosion treated
- Easy to read size measurement scale: fractional on one side, metric on the other
- Rounded hook-end doesn't leave marks or scratches on the valve
- Head combines slimness for accessibility with strength for performance



31 R US

BAHCO® ALLIGATOR ADJUSTABLE WRENCH

Industrial Grade Steel Handle, Black Phosphate Finish

Product Code	Length (Inches)	Maximum Jaw Opening (Inches)	Head Thickness (Inches)	Jaw Tip Thickness (Inches)
31 R US	8	1 1/4	1/2	3/16

Features

- V-jaw on wrench has aggressively angled teeth for sure grip on pipes and rounded fasteners
- Measurement scale on head conveniently shows fastener size
- Slim head with tapered jaws combine easy accessibility with extra turning strength
- Precision hardened and anti-corrosion treated



91CUS

BAHCO® SIDE NUT ADJUSTABLE WRENCHES

Comfortable Bigger and Rounded Handles, Chrome Finish

Product Code	Length (Inches)	Maximum Jaw Opening (Inches)	Head Thickness (Inches)	Jaw Tip Thickness (Inches)
91CUS	6	3/4	1/2	1/4
92CUS	8	1 1/4	1/2	5/16
93CUS	10	1 3/8	5/8	5/16
94CUS	12	1 1/2	3/4	3/8
95CUS	15	2	1	1/2
96CUS	21	2 1/2	1 1/8	5/8
97CUS	30	3	1 1/2	1

Features

- Side nut adjustable wrenches for heavy duty applications
- Forged in one piece for better performance
- Head angle 15° provides better accessibility
- Measurement scale on head conveniently shows fastener size

BAHCO® ERGO™ BIG-MOUTH ADJUSTABLE WRENCHES

Designed According to BAHCO®'s Scientific 11-Step Ergonomic Design Program

Product Code	Length (Inches)	Maximum Jaw Opening (Inches)	Head Thickness (Inches)	Jaw Tip Thickness (Inches)
Chrome Finish:				
9031 RC US	8	1 1/2	1/2	1/4
Black Phosphate Finish:				
9029 R US	6	1 1/4	1/2	3/16
9031 R US	8	1 1/2	1/2	1/4
9033 R US	10	1 3/4	5/16	3/4
9035 R US	12	2 3/16	3/8	7/8
Thin Jaw Wide Mouth:				
9029 RT US	6	1 1/4	11/64	1/4
9031 RT US	8	1 1/2	11/64	1/4

Features

- Extra-wide opening jaws with shorter handle for maximum access in confined areas
- True ERGO™ design, with thermoplastic handle and larger grip width
- Ideal for plumbers, electricians, and maintenance workers
- Slim head with tapered jaws combine easy accessibility with extra turning strength
- Perfect for working under the sink, within enclosures, or anywhere that a short handle is needed
- Thin Jaw Wide Mouth - 45% wider opening and 45% thinner jaw



9031 RC US



9029 R US



9031 R US

BAHCO® ERGO™ COMBINATION ADJUSTABLE/PIPE WRENCHES

Designed According to BAHCO®'s Scientific 11-Step Ergonomic Design Program

Product Code	Length (Inches)	Maximum Jaw Opening (Inches)	Head Thickness (Inches)	Max Pipe Diameter (Inches)
Chrome Finish:				
9070 RPC US	6	1 3/16	7/16	3/8
9071 RPC US	8	1 1/16	1/2	1/2
9072 RPC US	10	1 5/16	5/8	5/8
9073 RPC US	12	1 5/16	11/16	11/16
Black Phosphate Finish:				
9070 RP US	6	1 3/16	7/16	3/8
9071 RP US	8	1 1/16	1/2	1/2
9072 RP US	10	1 5/16	5/8	5/8
9073 RP US	12	1 5/16	11/16	11/16
Wide Mouth:				
9031 RP US	8	1 1/2	1/2	1 1/2

Features

- Unique reversible jaw combines the functions of an adjustable and pipe wrenches
- Simply reverse the jaw to change the grip
- Teeth are aggressively angled to provide maximum gripping power
- True ERGO™ design, with thermoplastic handle and larger grip width
- Ideal for plumbers, electricians, and maintenance workers
- Slim head with tapered jaws combine easy accessibility with extra turning strength



9072 RPC US



9072 RP US

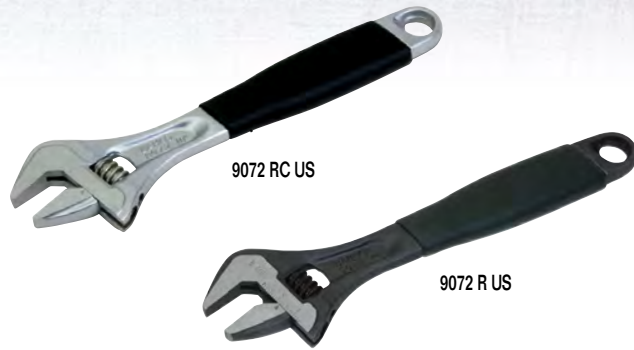

9072 RC US

9072 R US



8072 RC US

8072 R US

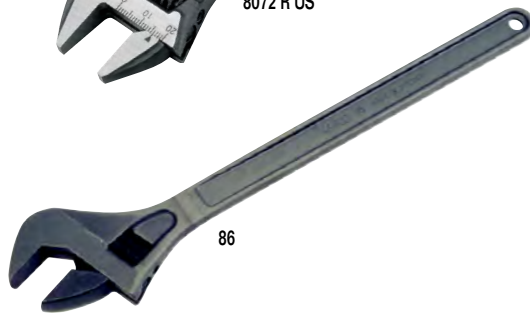

86



80RCUS3



80RUS3

BAHCO® ERGO™ ADJUSTABLE WRENCHES

Designed According to BAHCO®'s Scientific 11-Step Ergonomic Design Program

Product Code	Length (Inches)	Maximum Jaw Opening (Inches)	Head Thickness (Inches)	Jaw Tip Thickness (Inches)
Chrome Finish:				
9070 RC US	6	3/4	7/16	3/16
9071 RC US	8	1 1/16	1/2	1/4
9072 RC US	10	1 3/16	5/8	5/16
9073 RC US	12	1 5/16	11/16	7/16
Black Phosphate Finish:				
9070 R US	6	3/4	7/16	3/16
9071 R US	8	1 1/16	1/2	1/4
9072 R US	10	1 3/16	5/8	5/16
9073 R US	12	1 5/16	11/16	7/16

Features

- True ERGO™ design, with thermoplastic handle and larger grip width
- Ideal for plumbers, electricians, and maintenance workers
- Slim head with tapered jaws combine easy accessibility with extra turning strength
- Precision hardened and anti-corrosion treated
- Measurement scale on head conveniently shows fastener size

BAHCO® ADJUSTABLE WRENCHES

Industrial Grade Steel Handles

Product Code	Length (Inches)	Maximum Jaw Opening (Inches)	Head Thickness (Inches)	Jaw Tip Thickness (Inches)
Chrome Finish:				
8069 RC US	4	1/2	3/8	1/8
8070 RC US	6	3/4	7/16	3/16
8071 RC US	8	1 1/16	1/2	1/4
8072 RC US	10	1 1/8	5/8	5/16
8073 RC US	12	1 5/16	11/16	7/16
8074 RC US	15	1 11/16	13/16	9/16
8075 RC US	18	2 1/16	7/8	11/16
Black Phosphate Finish:				
8069 R US	4	1/2	3/8	1/8
8070 R US	6	3/4	7/16	3/16
8071 R US	8	1 1/16	1/2	1/4
8072 R US	10	1 1/8	5/8	5/16
8073 R US	12	1 5/16	11/16	7/16
8074 R US	15	1 11/16	13/16	9/16
8075 R US	18	2 1/16	7/8	11/16
86	24	2 7/16	1 1/16	1 1/16
87	30	3 5/16	1 3/16	1 3/16

80RCUS3

3 Piece Chrome Finish Adjustable Wrench Set, in Pouch

Contents Include:

Product Code	Size	Product Code	Size	Product Code	Size
8070 RC US	6	8071 RC US	8	8072 RC US	10

80RUS3

3 Piece Black Phosphate Finish Adjustable Wrench Set, in Pouch

Contents Include:

Product Code	Size	Product Code	Size	Product Code	Size
8070 R US	6	8071 R US	8	8072 R US	10

Features

- Slim head with tapered jaws combine easy accessibility with extra turning strength
- Measurement scale on head conveniently shows fastener size (except for 24" and 30" wrenches)
- Precision hardened and anti-corrosion treated

ADJUSTABLE

WRENCHES

ADJUSTABLE CONSTRUCTION WRENCH

Heavy-Duty With Polished Head and Measurement Scales

Product Code	Length (Inches)	Maximum Jaw Opening (Inches)	Head Thickness (Inches)
JHW13625A	15	1 1/2	23/32

Features

- Tapered spud handle locates and aligns bolts and rivets
- Hole in handle permits tethering wrench for safety
- Measurement scale on head conveniently shows fastener size
- Economical black phosphate finish resists rust



JHW13625A

SINGLE HEAD OPEN END OFFSET STRUCTURAL WRENCHES



Industrial Black Finish, SAE

Product Code	Size (Inches)	A	B	C	D
		Overall Length (Inches)	Open End Width (Inches)	Open End Thickness (Inches)	Handle Offset (Inches)
JHW1904A	3/4	11 9/16	1 19/32	19/32	7/8
JHW1905	7/8	14 3/16	2	9/16	1
JHW1906	1 1/16	14 3/16	1 31/32	19/32	1
JHW1906B	1	14 1/4	2	19/32	1
JHW1907	1 1/16	16 13/16	2 3/32	3/8	1 1/8
JHW1907A	1 1/8	16 13/16	2 1/4	3/8	1 1/8
JHW1908	1 1/4	17 11/16	2 23/32	11/16	1 1/4
JHW1908A	1 5/16	18 3/4	2 13/16	23/32	1 1/4
JHW1909	1 7/16	19 3/4	3 3/32	25/32	1 1/4
JHW1909A	1 1/2	19 7/8	3 3/32	25/32	1 1/2
JHW1910	1 5/8	21 1/16	3 7/32	7/8	1 1/2
JHW1911	1 13/16	23	3 3/4	1 3/4	1 5/8
JHW1911A	1 7/8	22 13/16	3 23/32	31/32	1 5/8
JHW1912	2	23 3/4	4 7/32	31/32	1 5/8

Features

- Long offset handle is designed for clearance of obstructions while providing greater leverage
- Tapered spud handle locates and aligns bolt and rivet holes



Made in U.S.A.

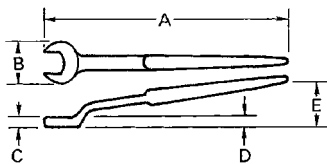

JHW1906B

SINGLE HEAD OPEN END CONSTRUCTION WRENCHES



Industrial Black Finish, SAE

Product Code	Size (Inches)	A	B	C
		Overall Length (Inches)	Open End Width (Inches)	Open End Thickness (Inches)
JHW204A	3/4	12	1 23/32	15/32
JHW205	7/8	14 1/4	2 1/16	19/32
JHW206	15/16	14 3/4	2 1/8	19/32
JHW206B	1	13 1/8	2 3/32	1/2
JHW207	1 1/16	16 9/16	2 7/16	21/32
JHW207A	1 1/8	17	2 9/16	11/16
JHWQ-208	1 1/4	18 15/16	2 23/32	23/32
JHW208A	1 5/16	19	2 27/32	3/4
JHW209	1 7/16	21 1/8	3 3/8	27/32
JHW209A	1 1/2	18 3/4	2 3/4	13/16
JHWQ-210	1 5/8	22 11/16	3 21/32	7/8
JHW211	1 13/16	25	4 1/2	1 1/32
JHW211A	1 7/8	25 1/8	4 9/16	1 1/16

Features

- 15° open end provides two gripping angles when wrench is turned over
- Tapered spud handle locates and aligns bolt and rivet holes



Made in U.S.A.

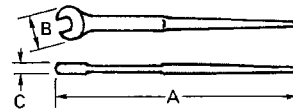

JHW206B



JHW8907A

OFFSET STRUCTURAL BOX WRENCHES



Industrial Black Finish, SAE

Product Code	Size (Inches)	A	B	C
		Overall Length (Inches)	Head Diameter (Inches)	Offset at End
JHW8905A	13/16	12	1 15/32	1 25/32
JHW8905	7/8	12	1 15/32	1 25/32
JHW8906	15/16	12	1 5/8	1 61/64
JHW8906B	1	12	1 5/8	1 61/64
JHW8907	1 1/16	15	1 53/64	2 9/64
JHW8907A	1 1/8	15	1 53/64	2 9/64
JHW8908	1 1/4	17	2 5/64	2 21/64
JHW8908A	1 5/16	17	2 5/64	2 21/64
JHW8909	1 7/16	21	2 3/8	2 3/4
JHW8909A	1 1/2	21	2 3/8	2 3/4
JHW8910	1 3/8	22	2 3/8	2 7/8
JHW8910A	1 11/16	22	2 5/8	2 7/8
JHW8911	1 13/16	23	2 29/32	3
JHW8911A	1 7/8	23	2 29/32	3
JHW8912	2	24 1/2	3 5/32	3 5/32
JHW8913	2 13/16	26	3 15/32	3 1/2
JHW8914	2 3/8	28	3 23/32	3 11/16
JHW8915	2 9/16	30	3 29/32	3 13/16
JHW8916	2 3/4	30	4 5/32	3 29/32

Fed. Spec: GGG-W-636E Type 9 Class 2

Features

- Offset from handle to permit clearance of obstructions
- Handles are tapered for insertion into bolt holes
- Industrial Black Finish



Made in U.S.A.

STRUCTURAL

WRENCHES

TUBULAR WRENCH HANDLES

Industrial Black Finish

Product Code	Length (Inches)	Inside Handle Diameter (Inches)
JHW13TH	13 1/2	7/8
JHW24TH	24	7/8
JHW36TH	36	1 1/8

Features

- For use with all Williams Tubular Handle Wrenches
- A detent on the wrench shaft helps to align locking button with handle hole
- Tubular wrenches may be used without the handle to quickly run down nuts



OPEN END TUBULAR HANDLE WRENCHES

Industrial Black Finish, SAE / Metric



Product Code	Size (Inches)	Size (MM)	B		C		Fits Handle No.
			Outside Head Diameter (Inches)	Head Depth (Inches)	Assembled Length From Bolt Center (Inches) 13TH	Assembled Length From Bolt Center (Inches) 24TH	
JHW1228TOE	7/8	-	1 15/16	1/2	19 3/8	29 7/8	JHW13TH - JHW24TH
JHW1230TOE	15/16	-	1 19/16	1/2	19 3/8	29 7/8	JHW13TH - JHW24TH
JHW1232TOE	1	-	2 9/16	9/16	20 5/32	30 21/32	JHW13TH - JHW24TH
JHW1234TOE	1 1/16	-	2 5/16	9/16	20 5/32	30 21/32	JHW13TH - JHW24TH
JHW1236TOE	1 1/8	-	2 9/16	9/16	20 5/32	30 21/32	JHW13TH - JHW24TH
JHW1240TOE	1 1/4	32	2 11/16	5/8	21 5/32	31 21/32	JHW13TH - JHW24TH
JHW1242TOE	1 5/16	33	2 11/16	5/8	21 5/32	31 21/32	JHW13TH - JHW24TH
JHW1244TOE	1 3/8	35	2 11/16	5/8	22	32 1/2	JHW13TH - JHW24TH
JHW1246TOE	1 7/16	36	3 1/8	11/16	22 1/16	32 9/16	JHW13TH - JHW24TH
JHW1248TOE	1 1/2	38	3 1/8	11/16	22 1/16	33 9/16	JHW13TH - JHW24TH

Features

- Unique, versatile design allows wrench to be used with or without optional handles
- Tubular wrenches may be used without the handle to quickly run down nuts
- The handle can then be attached to provide maximum turning power for final tightening or to reach otherwise inaccessible fasteners
- A detent on the wrench shaft helps to align locking button with handle hole
- Open end wrench head provides access in tight areas
- Sizes of both SAE and corresponding metric fasteners are shown

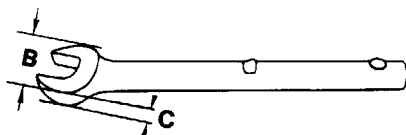

B = Outside Dia.
C = Head Depth

JHW13TH



JHW1228TOE

TUBULAR

WRENCHES



OFFSET BOX END TUBULAR HANDLE WRENCHES

Industrial Black Finish, 12 Point, SAE / Metric



JHW1234TOB

Product Code	Size (Inches)	Size (MM)	A		C		F		Assembled Length From Bolt Center (Inches) 13TH	Assembled Length From Bolt Center (Inches) 24TH/36TH	Fits Handle No.
			Outside Head Diameter (Inches)	Head Depth (Inches)	Head Depth (Inches)	Height of Offset (Inches)					
JHW1234TOB	1 1/16	-	1 21/32	5/8	1 5/16	1 1/16	9 3/32	30 3/32	JHW13TH - JHW24TH		
JHW1236TOB	1 1/8	-	1 7/8	23/32	1 1/8	1 1/16	9 7/32	30 7/32	JHW13TH - 24TH		
JHW1240TOB	1 1/4	32	1 29/32	23/32	1 1/8	1 1/16	9 7/32	30 7/32	JHW13TH - 24TH		
JHW1242TOB	1 5/16	33	2	27/32	1 1/8	1 1/16	11 1/2	32 1/2	JHW13TH - 24TH		
JHW1244TOB	1 3/8	35	2 1/16	7/8	1 3/16	1 1/16	11 19/32	32 19/32	JHW13TH - 24TH		
JHW1246TOB	1 7/16	36	2 5/32	7/8	1 1/4	1 1/16	11 19/32	32 19/32	JHW13TH - 24TH		
JHW1248TOB	1 1/2	38	2 1/4	15/16	1 5/16	1 1/16	11 19/32	32 19/32	JHW13TH - 24TH		
JHW1250TOB	1 9/16	40	2 5/16	15/16	1 5/16	1 1/16	11 19/32	32 19/32	JHW13TH - 24TH		
JHW1252TOB	1 5/8	41	2 3/8	3/32	1 3/8	1 1/16	11 23/32	32 23/32	JHW13TH - 24TH		
JHW1254TOB	1 11/16	43	2 19/32	1 1/16	1 7/16	1 1/16	43 3/32	43 3/32	JHW36TH		
JHW1256TOB	1 3/4	44	2 5/8	1 1/16	1 1/2	1 1/16	43 3/32	43 3/32	JHW36TH		
JHW1258TOB	1 13/16	46	2 23/32	1 1/8	1 9/16	1 1/16	43 13/32	43 13/32	JHW36TH		
JHW1260TOB	1 7/8	47	2 3/4	1 1/8	1 5/8	1 1/16	43 13/32	43 13/32	JHW36TH		
JHW1264TOB	2	51	2 31/32	1 1/4	1 3/4	1 1/16	43 1/2	43 1/2	JHW36TH		
JHW1266TOB	2 1/16	52	2 31/32	1 1/4	1 3/4	1 1/16	43 1/2	43 1/2	JHW36TH		
JHW1270TOB	2 3/16	55	3 3/16	1 5/16	1 7/8	1 1/16	43 19/32	43 19/32	JHW36TH		
JHW1272TOB	2 1/4	57	3 1/4	1 5/16	1 7/8	1 1/16	43 19/32	43 19/32	JHW36TH		
JHW1276TOB	2 3/8	60	3 13/32	1 13/32	2	1 1/16	43 11/16	43 11/16	JHW36TH		
JHW1282TOB	2 9/16	65	3 21/32	1 1/2	2 1/4	1 1/16	43 13/16	43 13/16	JHW36TH		
JHW1284TOB	2 5/8	67	3 11/16	1 1/2	2 1/4	1 1/16	44 7/32	44 7/32	JHW36TH		
JHW1288TOB	2 3/4	70	3 15/16	1 19/32	2 1/2	1 1/16	44	44	JHW36TH		
JHW1294TOB	2 15/16	75	4 3/32	1 11/16	2 3/8	1 1/16	44 3/32	44 3/32	JHW36TH		
JHW12100TOB	3 1/8	79	4 3/8	1 11/16	2 3/4	1 1/16	44 19/32	44 19/32	JHW36TH		

Features

- Unique, versatile design allows wrench to be used with or without optional handles
- Tubular Wrenches may be used without the handle to quickly run down nuts
- The handle can then be attached to provide maximum turning power for final tightening or to reach otherwise inaccessible fasteners
- A detent on the wrench shaft helps to align locking button with handle hole
- Offset box wrench head provides turning clearance
- Sizes of both SAE and corresponding metric fasteners are shown



Made in U.S.A.

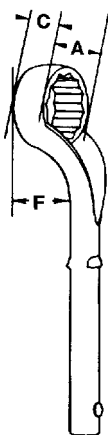

A = Outside Dia.
C = Head Depth
F = Height of Offset

JHW1224TSB

STRAIGHT BOX END TUBULAR HANDLE WRENCHES

Industrial Black Finish, 12 Point, SAE / Metric



Product Code	Size (Inches)	Size (MM)	A		C		Assembled Length From Bolt Center (Inches) 13TH	Assembled Length From Bolt Center (Inches) 24TH/36TH	Fits Handle No.
			Outside Head Diameter (Inches)	Head Depth (Inches)	Head Depth (Inches)	Height of Offset (Inches)			
JHW1224TSB	3/4	-	1 1/4	17/32	19 1/32	19 1/32	29 17/32	29 17/32	JHW13TH - JHW24TH
JHW1226TSB	13/16	-	1 1/4	17/32	19 1/32	19 1/32	29 17/32	29 17/32	JHW13TH - JHW24TH
JHW1228TSB	7/8	-	1 13/32	19/32	19 1/32	19 1/32	29 17/32	29 17/32	JHW13TH - JHW24TH
JHW1230TSB	15/16	-	1 13/32	19/32	19 1/32	19 1/32	29 17/32	29 17/32	JHW13TH - JHW24TH
JHW1232TSB	1	-	1 9/16	21/32	19 3/32	19 3/32	29 19/32	29 19/32	JHW13TH - JHW24TH
JHW1234TSB	1 1/16	-	1 9/16	21/32	19 3/32	19 3/32	29 19/32	29 19/32	JHW13TH - JHW24TH
JHW1236TSB	1 1/8	-	1 5/16	11/16	19 3/32	19 3/32	29 19/32	29 19/32	JHW13TH - JHW24TH
JHW1240TSB	1 1/4	32	1 29/32	27/32	21 13/32	21 13/32	31 29/32	31 29/32	JHW13TH - JHW24TH
JHW1242TSB	1 5/16	33	1 29/32	27/32	21 13/32	21 13/32	31 29/32	31 29/32	JHW13TH - JHW24TH
JHW1246TSB	1 7/16	36	2 5/32	7/8	21 13/32	21 13/32	31 29/32	31 29/32	JHW13TH - JHW24TH
JHW1248TSB	1 1/2	38	2 3/32	7/8	21 13/32	21 13/32	31 29/32	31 29/32	JHW13TH - JHW24TH
JHW1252TSB	1 5/8	41	2 3/16	15/16	22 7/32	22 7/32	32 23/32	32 23/32	JHW13TH - JHW24TH
JHW12100TSB	3 1/8	79	4 3/32	1 3/4	42 7/32	42 7/32	42 7/32	42 7/32	JHW36TH

Features

- Unique, versatile design allows wrench to be used with or without optional handles
- Tubular wrenches may be used without the handle to quickly run down nuts
- The handle can then be attached to provide maximum turning power for final tightening or to reach otherwise inaccessible fasteners
- A detent on the wrench shaft helps to align locking button with handle hole
- Straight box wrench head provides access when clearance is limited
- Sizes of both SAE and corresponding metric fasteners are shown



Made in U.S.A.

TUBULAR

WRENCHES

STRAIGHT PATTERN BOX END STRIKING WRENCHES



Industrial Black Finish, 12 Point, SAE / Metric

Product Code	Size (Inches)	Size (MM)	A	B	C
			Overall Length (Inches)	Box End Diameter (Inches)	Box End Thickness (Inches)
JHWSFH1808BW	1 3/16	30	7 9/16	2 3/32	7/8
JHWSFH-1808W	1 1/4	32	7 9/16	2 3/32	7/8
JHWSFH1808AW	1 5/16	33	7 9/16	2 3/32	7/8
JHWSFH1808CW	1 3/8	35	7 21/32	2 9/32	31/32
JHWSFH-1809W	1 7/16	-	7 21/32	2 9/32	31/32
JHWSFH1809BW	-	36	7 21/32	2 9/32	31/32
JHWSFH1809AW	1 1/2	38	7 21/32	2 9/32	31/32
JHWSFH-1810W	1 5/8	41	7 21/32	2 21/32	1 3/32
JHWSFH1810AW	1 11/16	43	7 19/16	2 21/32	1 9/32
JHWSFH1810BW	1 3/4	44	7 15/16	2 13/16	1 1/4
JHWSFH-1811W	1 13/16	46	7 15/16	2 13/16	1 1/4
JHWSFH1811AW	1 7/8	-	7 15/16	2 13/16	1 1/4
JHWSFH1812BW	-	50	11 19/32	3 3/16	1 13/32
JHWSFH-1812W	2	51	11 19/32	3 3/16	1 13/32
JHWSFH1812AW	2 1/16	52	11 19/32	3 3/16	1 13/32
JHWSFH-1813W	2 3/16	55	11 3/4	2 9/16	1 17/32
JHWSFH1813AW	2 1/4	57	11 3/4	2 9/16	1 17/32
JHWSFH-1814W	2 3/8	60	11 7/8	3 3/4	1 11/16
JHWSFH1814AW	2 7/16	62	11 7/8	3 3/4	1 11/16
JHWSFH1814BW	2 1/2	64	11 7/8	3 3/4	1 11/16
JHWSFH-1815W	2 9/16	65	13	4	1 13/16
JHWSFH1815AW	2 5/8	67	13	4	1 13/16
JHWSFH-1816W	2 3/4	70	14 9/32	4 9/32	1 15/16
JHWSFH1816AW	2 13/16	71	14 9/32	4 9/32	1 15/16
JHWSFH1816BW	2 15/16	75	14 13/32	4 17/32	2 1/16
JHWSFH1817AW	3	76	14 13/32	4 17/32	2 1/16
JHWSFH-1817W	3 1/8	80	17 19/32	4 29/32	2 9/32
JHWSFH1818AW	3 3/8	85	17 19/32	4 29/32	2 9/32
JHWSFH-1818W	3 1/2	89	17 19/16	5 5/16	2 15/32
JHWSFH1819BW	3 3/4	95	17 29/32	5 17/32	2 21/32
JHWSFH1819WA	3 7/8	98	17 29/32	5 17/32	2 21/32
JHWSFH1819CWA	4 1/8	105	18 7/32	6 1/32	2 15/16
JHWSFH1819AW	4 1/4	108	18 7/32	6 1/32	2 15/16
JHWSFH1820BWA	4 1/2	114	20 1/32	6 25/32	3 3/16
JHWSFH1820WA	4 5/8	117	20 1/32	6 25/32	3 3/16



JHWSFH-1812W

STRIKING

WRENCHES

Features

- Striking face wrenches are designed to be struck by a hammer on the anvil area in order to loosen frozen fasteners or to set and tighten fasteners
- Anvils are proportional to opening sizes
- Special heat treating provides maximum durability for long life
- Straight handle design resists springing while allowing the fastener to turn more easily
- Williams' expanded line of offset striking face wrenches, up to 4 5/8", provides the most extensive line on the market
- Specifically engineered to hold up under the most rigorous industrial use

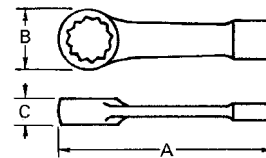

OFFSET PATTERN BOX END STRIKING WRENCHES



Industrial Black Finish, 12 Point, SAE / Metric



JHW8811BW

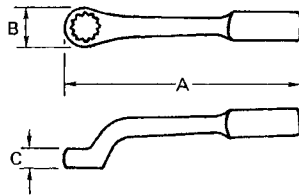

Product Code	Size (Inches)	Size (MM)	A	B	C
			Overall Length (Inches)	Box End Diameter (Inches)	Box End Thickness (Inches)
JHW8807W	1 1/16	27	9 3/32	1 21/32	23/32
JHW8807AW	1 1/8	-	10 31/32	1 15/16	3/4
JHW8808BW	1 3/16	30	10 31/32	1 15/16	3/4
JHW8808W	1 1/4	32	10 31/32	1 15/16	3/4
JHW8808AW	1 5/16	33	10 31/32	1 15/16	3/4
JHW8808CW	1 3/8	35	11 1/2	2 7/32	29/32
JHW8809W	1 7/16	-	11 1/2	2 5/32	29/32
JHW8809BW	-	36	11 1/2	2 7/32	29/32
JHW8809AW	1 1/2	38	12	2 7/16	1
JHW8810W	1 5/8	41	12	2 7/16	1
JHW8810AW	1 11/16	43	12 9/16	2 11/16	1 1/8
JHW8811BW	1 3/4	44	12 9/16	2 11/16	1 1/8
JHW8811W	1 13/16	46	12 9/16	2 11/16	1 1/8
JHW8811AW	1 7/8	-	13	2 7/8	1 1/4
JHW8812AW	1 15/16	49	13	2 7/8	1 1/4
JHW8812BW	-	50	13	2 7/8	1 1/4
JHW8812W	2	51	13	2 7/8	1 1/4
JHW8813BW	2 1/8	54	13 9/16	3 1/4	1 13/32
JHW8813W	2 3/16	55	13 9/16	3 1/4	1 13/32
JHW8813AW	2 1/4	57	13 9/16	3 1/4	1 13/32
JHW8814AW	2 3/16	59	13 9/16	3 1/4	1 13/32
JHW8814W	2 3/8	60	14 1/8	3 11/16	1 1/2
JHW8815BW	2 1/2	64	14 1/8	3 11/16	1 1/2
JHW8815W	2 9/16	65	14 1/8	3 11/16	1 1/2
JHW8815AW	2 5/8	67	15	3 15/16	1 5/8
JHW8816W	2 3/4	70	15	3 15/16	1 5/8
JHW8816CW	2 7/8	73	16	4 7/16	1 3/4
JHW8816BW	2 15/16	75	16	4 7/16	1 3/4
JHW8817AW	3	76	16	4 7/16	1 3/4
JHW8817W	3 1/8	80	16	4 7/16	1 3/4
JHW8818AW	3 3/8	85	18 9/32	6	2
JHW8818W	3 1/2	89	18 9/32	6	2
JHW8819BW	3 3/4	95	18 9/32	6	2
JHW8819W	3 7/8	98	18 9/32	6	2
JHW8819CW	4 1/8	105	18 9/32	6	2
JHW8819AW	4 1/4	108	18 9/32	6	2

Features

- Striking face wrenches are designed to be struck by a hammer on the anvil area in order to loosen frozen fasteners or to set and tighten fasteners
- Anvils are proportional to opening sizes
- Special heat treating provides maximum durability for long life
- Offset handle is close to head to provide clearance in confined areas
- Williams' expanded line of offset striking face wrenches, up to 4 1/4", provides the most extensive line on the market
- Specifically engineered to hold up under the most rigorous industrial use



STRIKING

WRENCHES

SLUGGING WRENCH RETAINERS

Product Code	Stud Size (Inches)	Length (Inches)	C (Inches)	D (Inches)
SWR-24	3/8	1 29/32	1 15/16	1 1/4
SWR-28	7/8	2	2 19/16	1 29/32
SWR-32	1	2 1/8	2 1/2	2 1/32
SWR-36	1 1/8	2 1/4	2 1/2	2 3/32
SWR-40	1 1/4	2 3/8	2 7/8	2 9/32
SWR-44	1 3/8	2 15/32	3 1/8	2 3/8
SWR-48	1 1/2	2 5/8	3 1/8	2 1/2
SWR-52	1 5/8	2 3/4	3 5/8	2 21/32
SWR-56	1 3/4	2 7/8	3 7/8	2 3/4
SWR-60	1 7/8	3	4 1/2	2 7/8



SWR-52



SWR-24

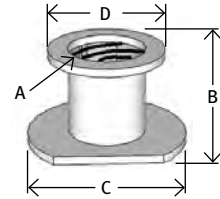

SWR-SET 10 Piece Slugging Wrench Retainers Set

Contents Include:

Product Code	Stud Size (Inches)	Product Code	Stud Size (Inches)
SWR-24	3/8	SWR-44	1 3/8
SWR-28	7/8	SWR-48	1 1/2
SWR-32	1	SWR-52	1 5/8
SWR-36	1 1/8	SWR-56	1 3/4
SWR-40	1 1/4	SWR-60	1 7/8

Features

- Slugging Wrench Retainers thread onto the end of the stud to ensure the wrench stays affixed to the fastener
- A spring loaded plate allows for easy adjustment of the wrench without having to unscrew the retainer.
- Increased productivity and safer operation by eliminating the need for a second worker to hold and slugging wrench in place
- Available in 10 sizes, marked with stud sizes (not hex sizes)
- Configured to work with offset and straight handle slugging wrenches



Made in U.S.A.



SWR-SET

RETAINERS/HAMMER

WRENCHES

HAMMER WRENCHES



6 Point

Product Code	Wrench Opening (Nut Size)	Head Dia. (Inches)	Head Thickness (Inches)	Overall Length (Inches)
JHWHW-6034	1 1/16	1 29/32	5/8	9 7/8
JHWHW-6040	1 1/4	2	23/32	10 1/4
JHWHW-6046	1 7/16	2 17/64	7/8	10 9/16
JHWHW-6052	1 5/8	2 31/64	61/64	11
JHWHW-6058	1 13/16	2 21/32	63/64	11 5/16
JHWHW-6064	2	3 1/32	1 7/32	11 11/16
JHWHW-6070	2 3/16	3 9/32	1 1/4	12
JHWHW-6076	2 3/8	3 13/32	1 7/16	12 3/8
JHWHW-6082	2 9/16	3 3/4	1 17/32	12 11/16
JHWHW-6088	2 3/4	4 1/64	1 17/32	13 1/16
JHWHW-6094	2 15/16	4 23/64	1 17/32	13 7/16
JHWHW-6100	3 1/8	4 31/64	1 5/8	13 13/16
JHWHW-6112	3 1/2	4 31/32	1 23/32	14 1/8
JHWHW-6124	3 7/8	5 39/64	1 29/32	14 1/2

Features

- Designed for use in the petrochemical industries where clearance, particularly on flanges, and cored fasteners are often a problem:
- 6 Point Hex is offset 15 degree, and short handle length allows for use in tight spaces
- Straight Handle transfers maximum torque when struck
- Assortment fits Stud Sizes up to 2 1/2"



Made in U.S.A.



JHWHW-6034





JHWS-476



JHWS-474



JHWS-483

ADJUSTABLE PIN SPANNER WRENCHES



Industrial Black Finish, SAE

Product Code	Span Diameter (Inches)	Pin Diameter (Inches)	Pin Length (Inches)	Overall Length (Inches)
JHWO-471	3/4 to 2	1/8	1/8	5 3/8
JHWO-471A	3/4 to 2	3/16	5/32	5 3/8
JHWO-472	1 1/4 to 3	3/16	3/16	6 7/8
JHWO-472A	1 1/4 to 3	1/4	7/32	6 7/8
JHWO-474	2 to 4 3/4	1/4	1/4	9 1/2
JHWO-474A	4 1/2 to 6 1/4	3/8	1/4	9 7/8

JHWS-476

6-Piece Adjustable Pin Spanner Wrench Set, in Pouch

Contents Include:

Product Code	Overall Length (Inches)	Product Code	Overall Length (Inches)
JHWO-471	5 3/8	JHWO-472A	6 7/8
JHWO-471A	5 3/8	JHWO-474	9 1/2
JHWO-472	6 7/8	JHWO-474A	9 7/8

Features

- Ideal for adjusting collars, lock nut rings, and bearings
- Specifically engineered to hold up under the most rigorous industrial use



Made in U.S.A.

ADJUSTABLE HOOK SPANNER WRENCHES



Industrial Black Finish, SAE

Product Code	Span Diameter (Inches)	Hook Depth (Inches)	Hook Thickness (Inches)	Overall Length (Inches)
JHW471	3/4 to 2	1/8	11/32	5 3/8
JHW472	1 1/4 to 3	5/32	13/32	7 1/4
JHW474	2 to 4 3/4	3/16	15/32	11 1/2
JHW474A	4 1/2 to 6 1/4	1/4	15/32	17 1/2
JHW474B	6 1/8 to 8 3/4	5/16	15/32	18 1/2

JHWS-474

4-Piece Adjustable Hook Spanner Wrench Set, in Pouch

Contents Include:

Product Code	Overall Length (Inches)	Product Code	Overall Length (Inches)
JHW471	5 3/8	JHW474	11 1/2
JHW472	7 1/4	JHW474A	17 1/2

Features

- Ideal for adjusting collars, lock nut rings, and bearings
- Specifically engineered to hold up under the most rigorous industrial use



Made in U.S.A.

ADJUSTABLE FACE SPANNER WRENCHES



Industrial Black Finish, SAE

Product Code	Span Diameter (Inches)	Pin Diameter (Inches)	Pin Length (Inches)	Overall Length (Inches)
JHW482	2	3/16	1/4	6 1/4
JHW483	3	1/4	1/4	8 1/8
JHW484	4	5/16	1/2	10 3/8

JHWS-483

3-Piece Adjustable Face Spanner Wrench Set, in Pouch

Contents Include:

Product Code	Overall Length (Inches)	Product Code	Overall Length (Inches)
JHW482	6 1/4	JHW484	10 3/8
JHW483	8 1/8		

Features

- Ideal for adjusting collars, lock nut rings, and bearings
- Specifically engineered to hold up under the most rigorous industrial use



Made in U.S.A.



T-HANDLE HEX DRIVERS

Cushion Grip Handle, SAE and Metric

Product Code	Size (Inches)	Product Code	Size (MM)
JHWHKT-3/32	3/32	JHWHKT-2MM	2
JHWHKT-7/64	7/64	JHWHKT-2.5MM	2.5
JHWHKT-1/8	1/8	JHWHKT-3MM	3
JHWHKT-9/64	9/64	JHWHKT-4MM	4
JHWHKT-5/32	5/32	JHWHKT-5MM	5
JHWHKT-3/16	3/16	JHWHKT-6MM	6
JHWHKT-7/32	7/32	JHWHKT-8MM	8
JHWHKT-1/4	1/4	JHWHKT-10MM	10
JHWHKT-5/16	5/16		
JHWHKT-3/8	3/8		

Features

- Cushion grip provides extra comfort
- One-Piece handle construction for extra strength
- 6 Inch shaft length

JHWWSHKT-10

10 Piece T-Handle Hex Driver Set, SAE in Pouch

Contents Include:

Product Code	Size (Inches)	Product Code	Size (Inches)	Product Code	Size (MM)
JHWHKT-3/32	3/32	JHWHKT-5/32	5/32	JHWHKT-1/4	1/4
JHWHKT-7/64	7/64	JHWHKT-3/16	3/16	JHWHKT-5/16	5/16
JHWHKT-1/8	1/8	JHWHKT-7/32	7/32	JHWHKT-3/8	3/8
JHWHKT-9/64	9/64				

JHMMWSHKT-8

8 Piece T-Handle Hex Driver Set, MM in Pouch

Contents Include:

Product Code	Size (MM)	Product Code	Size (MM)
JHWHKT-2MM	2	JHWHKT-5MM	5
JHWHKT-2.5MM	2.5	JHWHKT-6MM	6
JHWHKT-3MM	3	JHWHKT-8MM	8
JHWHKT-4MM	4	JHWHKT-10MM	10

Features

- Set comes in pouch for tool box or can be hung

Universal Hex Key Stand

Product Code	Size
JHWHKTSTAND	Width 7 1/2 x Depth 5 1/2 x Height 6

Features

- Universal T-handle stand, fits inch/metric sets
- Number of slots: 22
- Fits up to 3/8" hex
- For Inch, Metric and Torx hex keys
- Can be attached to wall, bench or each other
- T-handle hex drivers are sold separately and are not included with stand
- 6" overall length



JHWHKT-1/4



JHWHKT-6MM



JHWWSHKT-10

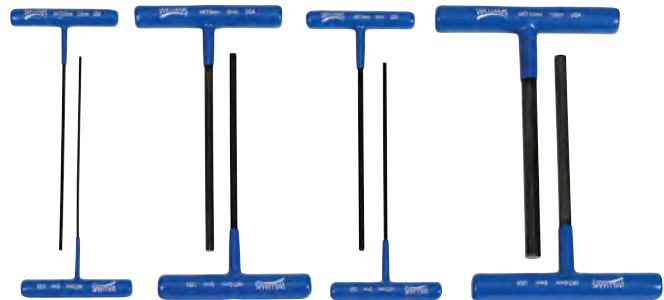

JHMMWSHKT-8



JHWHKTSTAND

HEX KEY

WRENCHES





FOLDING HEX KEY SETS

SAE and Metric

Product Code	JHWS-45		JHWS-46		JHMWS-47	
Number of Pieces	8		9		7	
	Hex Size (Inches)	Key Length (Inches)	Hex Size (Inches)	Key Length (Inches)	Includes Hex Size (MM)	Key Length (Inches)
	.050	1 1/4	5/64	1 1/2	1.5	1 3/8
	1/16	1 3/8	3/32	1 9/16	2	1 1/2
	3/64	1 7/16	7/64	1 11/16	2.5	1 5/8
	3/32	1 9/16	1/8	1 15/16	3	1 3/4
	7/64	1 5/8	9/64	2	4	2
	1/8	1 11/16	5/32	2 1/4	5	2 1/4
	9/64	1 13/16	3/16	2 1/2	6	2 1/2
	5/32	2	7/32	2 5/8		
			1/4	2 7/8		

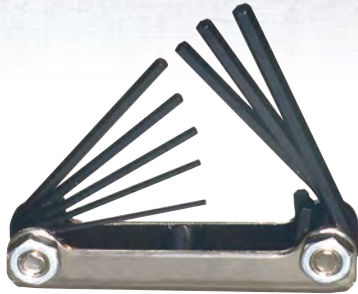

JHWS-45



JHWS-46



JHMWS-47

Features

- Steel case is chrome plated to resist corrosion
- Keys are black oxide finish
- Convenient item for pocket or tool box



Made in U.S.A.

BALL END AND STANDARD HEX KEY SETS



SAE and Metric, in Handy Compact Plastic Holder

Product Code	Number of Pieces	Type	Key Style	Key Length	Size Range
JHW10107	7	SAE	Standard	Short	5/64 - 1/4"
JHW10111	11	SAE	Standard	Short	.050 - 1/4"
JHW10113	13	SAE	Standard	Short	.050 - 3/8"
JHW10213	13	SAE	Standard	Long	.050 - 3/8"
JHW10507	7	Metric	Standard	Short	1.5 - 6.0 mm
JHW10509	9	Metric	Standard	Short	1.5 - 10.0 mm
JHW13213	13	SAE	Ball Hex	Long	.050 - 3/8"
JHW13609	9	Metric	Ball Hex	Long	1.5 - 10.0 mm

Features

- Plastic holders organize hex keys securely in place.
- Keys are black oxide finish.
- Holders are color coded, red for fractional and blue for metric.
- Ball hex key ends are designed with ball on long arm to provide 360° of rotation at up to a 30° angle.



HEX KEY SETS IN POUCH



SAE and Metric

Product Code	JHWW-44		JHWMWS-27	
Number of Pieces	13		11	
	Hex Size (Inches)	Key Length (Inches)	Hex Size (MM)	Key Length (Inches)
	.050	1 11/16	2	2
	1/16	1 13/16	2 1/2	2 5/16
	3/64	1 31/32	3	2 7/32
	3/32	2 1/8	4	2 13/16
	7/64	2 1/4	5	3 5/16
	1/8	2 3/8	6	3 23/32
	9/64	2 9/16	8	4 1/16
	5/32	2 19/32	10	4 5/8
	3/16	3	12	5 7/32
	7/32	3 7/16	14	5 15/16
	1/4	3 1/2	17	6 7/8
	5/16	4		
	3/8	4 17/32		

Features

- Pouch keeps hex keys organized.
- Keys are black oxide finish.



JHWMWS-27

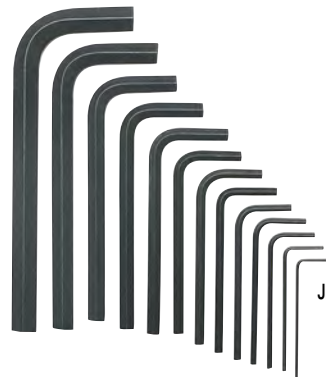

JHWW-44



JHWHK-050

HEX KEY

WRENCHES

L-TYPE HEX KEYS



Industrial Black Finish, SAE

Product Code	Size (Inches)	Length (Inches)	Width (Inches)	Pkg. Qty.
JHWHK-050	.050	1 23/32	1/2	25
JHWHK-1/16	1/16	1 7/8	1/2	25
JHWHK-3/64	3/64	1 31/32	5/8	25
JHWHK-3/32	3/32	1 13/16	9/16	25
JHWHK-7/64	7/64	2 1/4	23/32	25
JHWHK-1/8	1/8	2 13/32	3/4	25
JHWHK-9/64	9/64	2 3/8	25/32	25
JHWHK-5/32	5/32	2 21/32	27/32	25
JHWHK-3/16	3/16	2 31/32	1	25
JHWHK-7/32	7/32	3 3/16	1	25
JHWHK-1/4	1/4	3 5/8	1 1/8	25
JHWHK-3/8	3/8	4 23/32	1 13/32	5

Features

- Keys are black oxide finish.



L-TYPE HEX KEYS



Industrial Black Finish, Metric

Product Code	Size (MM)	Length (Inches)	Width (Inches)	Pkg. Qty.
JHWHK-2mm	2	2	5/8	25
JHWHK-2.5mm	2 1/2	2 1/4	23/32	25
JHWHK-3mm	3	2 9/16	13/16	25
JHWHK-4mm	4	2 13/16	31/32	25
JHWHK-5mm	5	3 13/32	1 1/8	25
JHWHK-6mm	6	3 3/4	1 1/8	10
JHWHK-8mm	8	4 3/16	1 1/8	5
JHWHK-10mm	10	4 3/4	1 1/2	5
JHWHK-12mm	12	5 1/4	1 5/8	5
JHWHK-14mm	14	6	1 1/2	5
JHWHK-17mm	17	6 3/4	2 1/2	1

Features

- Keys are black oxide finish.



SOCKET AND DRIVE TOOLS

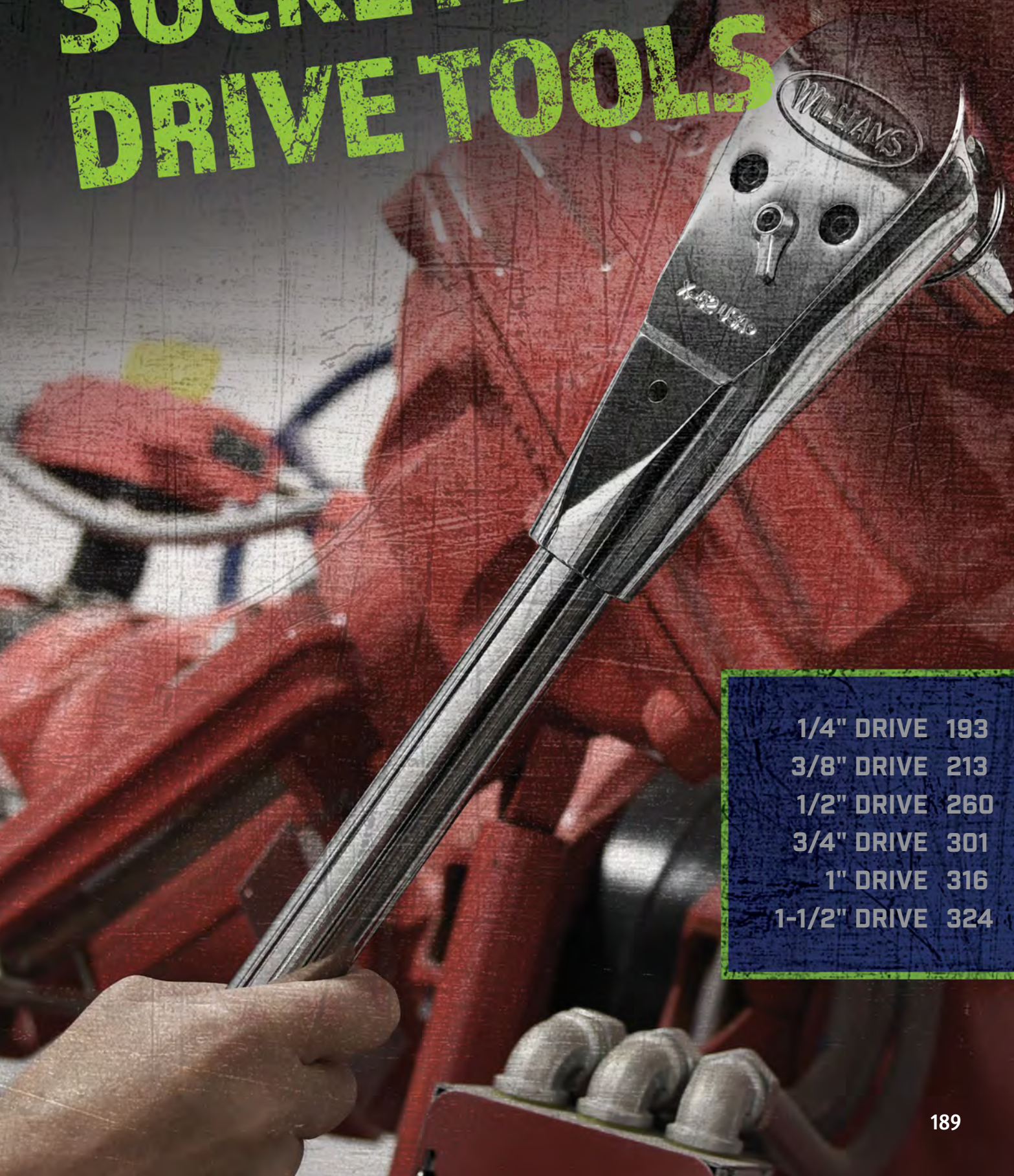

1/4" DRIVE	193
3/8" DRIVE	213
1/2" DRIVE	260
3/4" DRIVE	301
1" DRIVE	316
1-1/2" DRIVE	324

RATCHETS AND DRIVE TOOLS

Single pawl ratchet design is designed for tighter tolerances between pawl and gear which reduces metal fatigue and slippage under load and does not require as many working parts, reducing possible breakage and parts to repair

Enclosed head prevents dust, dirt, and liquids from entering head, preserving internal lubrication

36-tooth gear with 10° of engagement allowing easier ratcheting in tight conditions

Easy access reverse lever for changing working direction quickly and easily with only one hand

Forged, one-piece ratchet provides strength and safety for industrial applications

Nickel/Chrome plating provides increased protection from rust and corrosion

Smooth, comfort-grip handle permits all-day use without gloves

CHROME SOCKETS

SUPERTORQUE™ lobular openings for greater turning power without deforming the fastener

Chrome finish feature mirror-like exterior that can be easily cleaned after each use

Extruded or hot broached from alloy steel, precision machined and fully heat treated

Chamfered ends provides easy engagement of the drive tool and fastener



EXTENSIONS AND ACCESSORIES

Ball and spring socket retention



SOCKET AND DRIVE TOOLS

IMPACT SOCKETS

SUPERTORQUE™ lobular openings for greater turning power without deforming the fastener



Designed for maximum engagement on 6 point fasteners

Heavy Duty - suitable for use with pneumatic and electric impact wrenches



Specially heat treated for impact use to provide long life, safety, and durability

HEAVY-DUTY FASTENER MANAGEMENT

FLEXTENSIONS

Socket retention pin is TIG welded, providing full rotation power to the socket

Up to 30° angle offset

SUPERTORQUE™ lobular openings for greater turning power without deforming the fastener

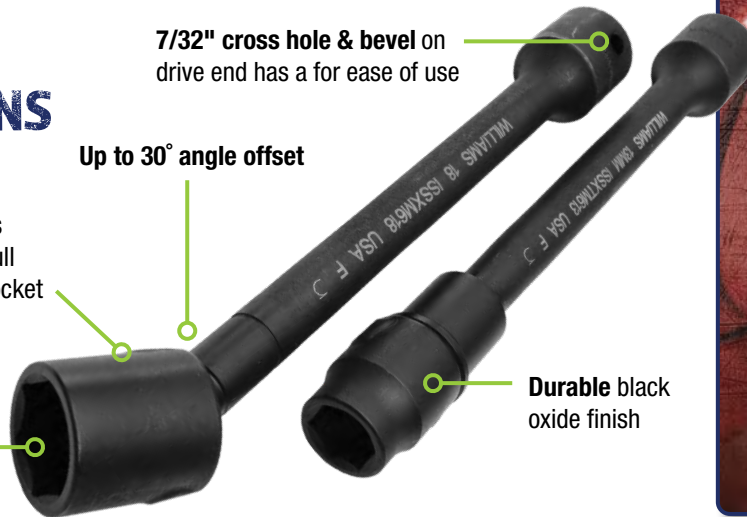

7/32" cross hole & bevel on drive end has a for ease of use

Durable black oxide finish

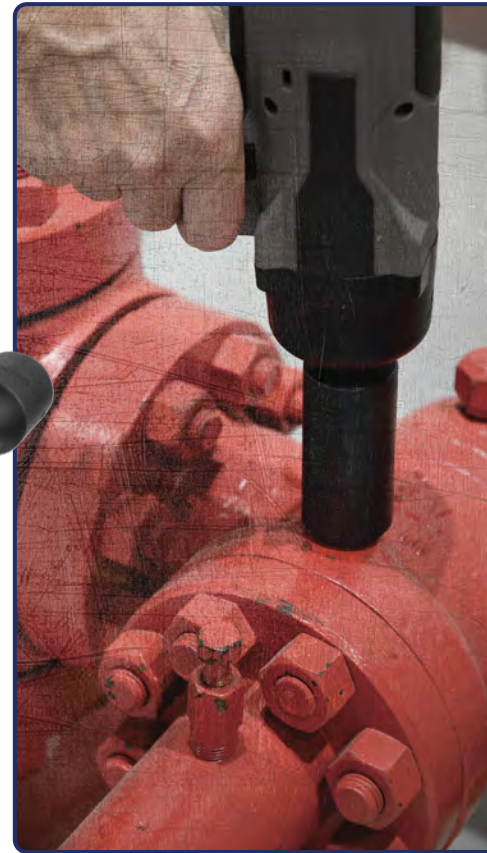

TURBOSOCKET® SALVAGE SOCKETS

- Quickly and easily remove damaged or rounded nuts and bolts
- For use with ratchet, breaker bar or T-handle
- Grip on fastener tightens as more torque is applied
- No hammering is required to install socket over fastener
- Use on all types of standard nuts and bolts as well as studs, pipe nipples, and corroded auto and marine fasteners
- May be used for "best fit" on metric and fractional fasteners
- May be used with air or electric impact wrench for extra speed and turning power



MULTI DRIVE SOCKET & DRIVE TOOL SETS

Product Code	Description
JHW50614B	146 Piece 1/4", 3/8", 1/2" Drive Socket Set 6 Point Rugged Case System Tool Set, SAE & Metric Complete details on page 197, 222, 267
JHW50612B	138 Piece 1/4", 3/8", 1/2" Drive Socket Set 6 Point Rugged Case System Tool Set, SAE & Metric Complete details on page 198, 223, 268
JHW50611B	95 Piece 1/4" & 3/8" Drive Master Socket, Wrench, and Screwdriver Set 6 & 12 Point Rugged Case System Tool Set, SAE Complete details on page 199, 224
JHW50622B	89 Piece 1/4" & 3/8" Drive Master Socket and Tool Set 6 & 12 Point Rugged Case System Tool Set, Metric Complete details on page 200, 255
JHW50681	32 Piece 1/4" & 3/8" Drive Bit Socket Set 6 Point Compact Case Tool Set, SAE & Metric Complete details on page 202

Features

- Sets include comprehensive assortment of sockets and drive tools in multiple drive sizes
- All tools are professional quality, made of high-grade chrome vanadium steel
- Sockets feature SUPERTORQUE™ lobular openings for greater turning power without deforming the fastener
- Packed in rugged high-density polyethylene (HDPE) cases that are strong and durable yet light in weight
- Rugged case is shock proof at both high and low temperatures, equipped with heavy-duty metal latches and hinges
- Two component handles are easy to grip and comfortable to carry



JHW50614B



JHW50612B



JHW50611B



JHW50622B



JHW50681

38 PIECE 1/4" DRIVE SOCKET & DRIVE TOOL SET



JHWWSM38HFTB

Features

- Keep-Safe-Foam system keeps tools organized and helps prevent loss
- All tools are professional quality, made of high-grade chrome vanadium steel
- Sockets feature SUPERTORQUE™ lobular openings for greater turning power without deforming the fastener
- Metal tool box made for years of rugged use

6 & 8 Point SAE, Packed in Exclusive Keep-Safe-Foam System with Metal Box

Product Code	Description
JHWWSM38HFTB	38 Piece Tool Set with TB-103 Metal Tool Box
JHWWSM-38HF	38 Piece Tool Set Only - Packed in Keep Safe Foam System

Contents Include:

Drive Tools:		Drive Tools:	
Product Code	Description	Product Code	Description
JHWM-52EHA	5 1/2" Enclosed Head Ratchet	JHWM-106A	Spinner Handle
JHWM-42A	Flex Handle	JHWM-140A	Universal Joint
JHWM-102	2" Extension	JHW30008	Sliding T-Handle
JHWM-104	4" Extension	JHWMFE-6	6" Flexible Extension
JHWM-115	6" Extension		

Shallow 6-Point Sockets

Product Code	Size (Inches)
JHWM-605	5/32
JHWM-606	3/16
JHWM-607	7/32
JHWM-608	1/4
JHWM-609	9/32
JHWM-610	5/16
JHWM-611	11/32
JHWM-612	3/8
JHWM-614	7/16
JHWM-616	1/2
JHWM-618	9/16

Deep 6-Point Sockets

Product Code	Size (Inches)
JHWMD-606	3/16
JHWMD-607	7/32
JHWMD-608	1/4
JHWMD-609	9/32
JHWMD-610	5/16
JHWMD-611	11/32
JHWMD-612	3/8
JHWMD-614	7/16
JHWMD-616	1/2
JHWMD-618	9/16

Screwdriver Bit Sockets

Product Code	Description
JHW35051	#1 Phillips® Tip
JHW35052	#2 Phillips® Tip
JHW35040	5/32" Slotted Tip
JHW35041	7/32" Slotted Tip
JHW35042	9/32" Slotted Tip

Shallow 8-Point Sockets

Product Code	Size (Inches)
JHWM-808	1/4
JHWM-810	5/16
JHWM-812	3/8



26 PIECE 1/4" DRIVE SOCKET AND DRIVE TOOL SET



JHWWSM26HFTB

Features

- Keep-Safe-Foam system keeps tools organized and helps prevent loss
- All tools are professional quality, made of high-grade chrome vanadium steel
- Sockets feature SUPERTORQUE™ lobular openings for greater turning power without deforming the fastener
- Metal tool box made for years of rugged use

6 Point SAE, Packed in Exclusive Keep-Safe-Foam System with Metal Box

Product Code	Description
JHWWSM26HFTB	26 Piece Tool Set with TB-102 Metal Tool Box
JHWWSM-26HF	26 Piece Tool Set Only - Packed in Keep Safe Foam System

Contents Include:

Drive Tools:		Drive Tools:	
Product Code	Description	Product Code	Description
JHWM-52EHA	5 1/2" Enclosed Head Ratchet	JHWM-106A	Spinner Handle
JHWM-102	2" Extension	JHWM-140A	Universal Joint
JHWM-115	6" Extension		

Shallow 6-Point Sockets

Product Code	Size (Inches)
JHWM-605	3/32
JHWM-606	3/16
JHWM-607	7/32
JHWM-608	1/4
JHWM-609	9/32
JHWM-610	5/16
JHWM-611	11/32
JHWM-612	3/8
JHWM-614	7/16
JHWM-616	1/2
JHWM-618	9/16

Deep 6-Point Sockets

Product Code	Size (Inches)
JHWMD-606	3/16
JHWMD-607	7/32
JHWMD-608	1/4
JHWMD-609	9/32
JHWMD-610	5/16
JHWMD-611	11/32
JHWMD-612	3/8
JHWMD-614	7/16
JHWMD-616	1/2
JHWMD-618	9/16



1/4" DRIVE

SOCKETS AND DRIVE TOOLS

22 PIECE 1/4" DRIVE SOCKET AND DRIVE TOOL SET



6 & 12 Point SAE, Packed in Exclusive Keep-Safe-Foam System with Metal Box

Product Code	Description
JHWSM-22FTB	22 Piece Tool Set with TB-102 Metal Tool Box
JHWSM-22F	22 Piece Tool Set Only - Packed in Keep Safe Foam System

Contents Include:

Drive Tools:		Deep 6-Point Sockets	
Product Code	Description	Product Code	Size (Inches)
JHWM-52EHA	5 1/2" Enclosed Head Ratchet	JHWMD-605	5/32
JHWM-102	2" Extension	JHWMD-606	3/16
JHWM-106A	Spinner Handle	JHWMD-608	1/4
JHWM-140A	Universal Joint		

Shallow 6-Point Sockets		Deep 12-Point Sockets	
Product Code	Size (Inches)	Product Code	Size (Inches)
JHWM-605	5/32	JHWMD-1210	5/16
JHWM-606	3/16	JHWMD-1211	11/32
JHWM-608	1/4	JHWMD-1212	3/8
		JHWMD-1214	7/16
		JHWMD-1216	1/2
		JHWMD-1218	9/16

Shallow 12-Point Sockets	
Product Code	Size (Inches)
JHWM-1210	5/16
JHWM-1211	11/32
JHWM-1212	3/8
JHWM-1214	7/16
JHWM-1216	1/2
JHWM-1218	9/16

Features

- Keep-Safe-Foam system keeps tools organized and helps prevent loss
- All tools are professional quality, made of high-grade chrome vanadium steel
- Sockets feature SUPERTORQUE™ lobular openings for greater turning power without deforming the fastener
- Metal tool box made for years of rugged use



JHWSM-22FTB

19 PIECE 1/4" DRIVE SOCKET AND DRIVE TOOL SET



6 & 8 Point SAE, Packed in Exclusive Keep-Safe-Foam System with Metal Box

Product Code	Description
JHWSM19HFTB	19 Piece Tool Set with TB-101 Metal Tool Box
JHWSM-19HF	19 Piece Tool Set Only - Packed in Keep Safe Foam System

Contents Include:

Drive Tools:		Shallow 6-Point Sockets	
Product Code	Description	Product Code	Size (Inches)
JHWM-52EHA	5 1/2" Enclosed Head Ratchet	JHWM-606	3/16
JHWM-102	2" Extension	JHWM-607	7/32
JHWM-115	6" Extension	JHWM-608	1/4
JHWM-106A	Spinner Handle	JHWM-609	9/32
JHWM-140A	Universal Joint	JHWM-610	5/16
JHWM-42A	Flex Handle	JHWM-611	11/32
		JHWM-612	3/8
		JHWM-614	7/16
		JHWM-616	1/2
		JHWM-618	9/16

Shallow 8-Point Sockets	
Product Code	Size (Inches)
JHWM-808	1/4
JHWM-810	5/16
JHWM-812	3/8

Features

- Keep-Safe-Foam system keeps tools organized and helps prevent loss
- All tools are professional quality, made of high-grade chrome vanadium steel
- Sockets feature SUPERTORQUE™ lobular openings for greater turning power without deforming the fastener
- Metal tool box made for years of rugged use



JHWSM19HFTB

1/4" DRIVE

SOCKETS AND DRIVE TOOLS



15 PIECE 1/4" DRIVE SOCKET AND DRIVE TOOL SET



6 Point SAE, Packed in Exclusive Keep-Safe-Foam System with Metal Box

Product Code	Description
JHWSM15HFTB	15 Piece Tool Set with TB-101 Metal Tool Box
JHWSM-15HF	15 Piece Tool Set Only - Packed in Keep Safe Foam System

Contents Include:

Drive Tools:

Product Code	Description	Product Code	Description
JHWM-52EHA	5 1/2" Enclosed Head Ratchet	JHWM-106A	Spinner Handle
JHWM-102	2" Extension	JHWM-140A	Universal Joint
JHWM-115	6" Extension		

Shallow 6-Point Sockets

Product Code	Size (Inches)	Product Code	Size (Inches)
JHWM-606	3/16	JHWM-611	11/32
JHWM-607	7/32	JHWM-612	3/8
JHWM-608	1/4	JHWM-614	7/16
JHWM-609	9/32	JHWM-616	1/2
JHWM-610	5/16	JHWM-618	9/16

Features

- Keep-Safe-Foam system keeps tools organized and helps prevent loss
- All tools are professional quality, made of high-grade chrome vanadium steel
- Sockets feature SUPERTORQUE™ lobular openings for greater turning power without deforming the fastener
- Metal tool box made for years of rugged use



JHWSM15HFTB

13 PIECE 1/4" DRIVE SOCKET AND DRIVE TOOL SET



6 & 12 Point SAE, Packed in Exclusive Keep-Safe-Foam System with Metal Box

Product Code	Description
JHWSM-13FTB	13 Piece Tool Set with TB-101 Metal Tool Box
JHWSM-13F	13 Piece Tool Set Only - Packed in Keep Safe Foam System

Contents Include:

Drive Tools:

Product Code	Description	Product Code	Size (Inches)
JHWM-52EHA	5 1/2" Enclosed Head Ratchet	JHWM-1208	1/4
JHWM-102	2" Extension	JHWM-1210	5/16
JHWM-106A	Spinner Handle	JHWM-1211	11/32
JHWM-140A	Universal Joint	JHWM-1212	3/8
		JHWM-1214	7/16
		JHWM-1216	1/2
		JHWM-1218	9/16

Shallow 6-Point Sockets

Product Code	Size (Inches)
JHWM-605	5/32
JHWM-606	3/16

Features

- Keep-Safe-Foam system keeps tools organized and helps prevent loss
- All tools are professional quality, made of high-grade chrome vanadium steel
- Sockets feature SUPERTORQUE™ lobular openings for greater turning power without deforming the fastener
- Metal tool box made for years of rugged use



JHWSM-13FTB

1/4" DRIVE

SOCKETS AND DRIVE TOOLS

30 PIECE 1/4" DRIVE SOCKET AND DRIVE TOOL SET



6 Point Metric, Packed in Exclusive Keep-Safe-Foam System with Metal Box

Product Code	Description
JHWMSM30HFTB	30 Piece Metric Tool Set with TB-103 Metal Tool Box
JHWMSM-30HF	30 Piece Tool Set Only - Packed in Keep Safe Foam System

Contents Include:

Drive Tools:

Product Code	Description	Product Code	Description
JHWM-52EHA	5 1/2" Enclosed Head Ratchet	JHWM-106A	Spinner Handle
JHWM-102	2" Extension	JHWM-140A	Universal Joint
JHWM-115	6" Extension	JHWM-42A	Flex Handle

Shallow 6-Point Sockets

Product Code	Size (MM)	Product Code	Size (MM)
JHWM-604	4	JHWMMD-604	4
JHWM-605	5	JHWMMD-605	5
JHWM-605.5	5 1/2	JHWMMD-605.5	5 1/2
JHWM-606	6	JHWMMD-606	6
JHWM-607	7	JHWMMD-607	7
JHWM-608	8	JHWMMD-608	8
JHWM-609	9	JHWMMD-609	9
JHWM-610	10	JHWMMD-610	10
JHWM-611	11	JHWMMD-611	11
JHWM-612	12	JHWMMD-612	12
JHWM-613	13	JHWMMD-613	13
JHWM-614	14	JHWMMD-614	14

Deep 6-Point Sockets



JHWMSM30HFTB

Features

- Keep-Safe-Foam system keeps tools organized and helps prevent loss
- All tools are professional quality, made of high-grade chrome vanadium steel
- Sockets feature SUPERTORQUE™ lobular openings for greater turning power without deforming the fastener
- Metal tool box made for years of rugged use



17 PIECE 1/4" DRIVE SOCKET AND DRIVE TOOL SET



6 Point Metric, Packed in Exclusive Keep-Safe-Foam System with Metal Box

Product Code	Description
JHWMSM17HFTB	17 Piece Metric Tool Set with TB-101 Metal Tool Box
JHWMSM-17HF	17 Piece Tool Set Only - Packed in Keep Safe Foam System

Contents Include:

Drive Tools:

Product Code	Description	Product Code	Description
JHWM-52EHA	5-1/2" Enclosed Head Ratchet	JHWM-106A	Spinner Handle
JHWM-102	2" Extension	JHWM-140A	Universal Joint
JHWM-115	6" Extension		

Shallow 6-Point Sockets

Product Code	Size (MM)	Product Code	Size (MM)
JHWM-604	4	JHWM-609	9
JHWM-605	5	JHWM-610	10
JHWM-605.5	5.5	JHWM-611	11
JHWM-606	6	JHWM-612	12
JHWM-607	7	JHWM-613	13
JHWM-608	8	JHWM-614	14



JHWMSM17HFTB

Features

- Keep-Safe-Foam system keeps tools organized and helps prevent loss
- All tools are professional quality, made of high-grade chrome vanadium steel
- Sockets feature SUPERTORQUE™ lobular openings for greater turning power without deforming the fastener
- Metal tool box made for years of rugged use



1/4" DRIVE

SOCKETS AND DRIVE TOOLS





JHW50614B

Features

- All tools are professional quality, made of high-grade chrome vanadium steel
- Sockets feature SUPERTORQUE™ lobular openings for greater turning power without deforming the fastener
- Packed in rugged high-density polyethylene (HDPE) cases that are strong and durable yet light in weight
- Case is shock proof at both high and low temperatures, equipped with heavy-duty metal latches and hinges
- Two-component handles are easy to grip and comfortable to carry

**146 PIECE
1/4", 3/8", 1/2" DRIVE
SOCKET AND DRIVE TOOL SET**



6 & 12 Point Rugged-Case-System Tool Set, SAE and Metric

Product Code	Description
JHW50614B	146 Piece 1/4", 3/8", 1/2" Drive Socket Set

1/4" Drive Contents Include:

1/4" Drive Tools

- Ratchet
- 3" Extension
- Handle
- Universal Joint

1/4" Drive Deep 6 Point Sockets

Metric Size (MM)	SAE Size (Inches)
4	3/16
5	7/32
6	1/4
7	9/32
8	5/16
9	11/32
10	3/8
11	7/16
12	1/2
13	

1/4" Drive Shallow 6 Point Sockets

Metric Size (MM)	SAE Size (Inches)
4	5/32
5	3/16
5.5	7/32
6	1/4
7	9/32
8	5/16
9	11/32
10	3/8
11	7/16
12	1/2
13	9/16
14	

1/4" Drive Hex Bit Sockets

Metric Size (MM)	SAE Size (Inches)
3	1/8
4	5/32
5	3/16
6	7/32
7	1/4
8	5/16

1/4" Drive Screw-driver Bit Sockets

Size	Size
5/32" Slotted Tip	#0 Phillips Tip
7/32" Slotted Tip	#1 Phillips Tip
9/32" Slotted Tip	#2 Phillips Tip

1/4" Drive Torx Bit Sockets

Size	Size
T10	T25
T15	T27
T20	T30

3/8" Drive Contents Include:

3/8" Drive Tools

- Ratchet
- 3" Extension
- 6" Extension
- Adaptor - 3/8" F x 1/4" M

3/8" Drive Deep 12 Point Sockets

Metric Size (MM)	SAE Size (Inches)
6	1/4
7	5/16
8	3/8
9	7/16
10	1/2
11	9/16
12	5/8
13	11/16
14	3/4
15	13/16
16	7/8
17	15/16
18	1
19	

3/8" Drive Shallow 6 Point Sockets

Metric Size (MM)	SAE Size (Inches)
6	1/4
7	5/16
8	3/8
9	7/16
10	1/2
11	9/16
12	5/8
13	11/16
14	3/4
15	13/16
16	7/8
17	15/16
18	1
19	

3/8" Drive Spark Plug Socket

SAE Size (Inches)
5/8
13/16

1/2" Drive Contents Include:

1/2" Drive Tools

- Ratchet
- 6" Extension
- 10" Extension
- Universal Joint
- Adaptor - 1/2" F x 3/8" M

1/2" Drive Shallow 12 Point Sockets

SAE Size (Inches)
3/8
7/16
1/2
9/16
5/8
11/16
3/4
13/16
7/8
15/16
1

1/4" DRIVE

SOCKETS AND DRIVE TOOLS

**138 PIECE
1/4", 3/8", 1/2" DRIVE
SOCKET AND DRIVE TOOL SET**



6 Point Rugged-Case-System Tool Set, SAE and Metric

Product Code	Description
JHW50612B	138 Piece 1/4", 3/8", 1/2" Drive Socket Set

1/4" Drive Contents Include:

1/4" Drive Tools

- Ratchet
- 1 1/2" Extension
- 3" Extension
- Spinner Handle
- Universal Joint
- Hex Bit Holder

13 Piece Insert Bit Set

1/4" Drive Deep 6 Point Sockets

Metric Size (MM)	SAE Size (Inches)
4	5/32
5	3/16
6	7/32
7	1/4
8	9/32
9	5/16
10	11/32
11	3/8
12	7/16
13	1/2

1/4" Drive Shallow 6 Point Sockets

Metric Size (MM)	SAE Size (Inches)
4	5/32
5	3/16
5.5	7/32
6	1/4
7	9/32
8	5/16
9	11/32
10	3/8
11	7/16
12	1/2
13	

3/8" Drive Contents Include:

3/8" Drive Tools

- Ratchet
- 3" Extension
- 6" Extension
- Universal Joint
- Adaptor
- Hex Bit Holder

3/8" Drive Deep 12 Point Sockets

Metric Size (MM)	SAE Size (Inches)
10	3/8
11	7/16
12	1/2
13	9/16
14	5/8
15	11/16
16	3/4
17	13/16
18	7/8
19	

3/8" Drive Shallow 6 Point Sockets

Metric Size (MM)	SAE Size (Inches)
10	3/8
11	7/16
12	1/2
13	9/16
14	5/8
15	11/16
16	3/4
17	
18	
19	

1/2" Drive Contents Include:

1/2" Drive Tools

- Ratchet
- 6" Extension
- 10" Extension
- Universal Joint
- Adaptor

1/2" Drive 12 Point Sockets

Metric Size (MM)	SAE Size (Inches)
10	3/8
11	7/16
12	1/2
13	9/16
14	5/8
15	11/16
16	3/4
17	13/16
18	7/8
19	
21	1
22	1 1/16
24	1 1/8
27	1 3/16
30	1 1/4
32	



JHW50612B

Features

- All tools are professional quality, made of high-grade chrome vanadium steel
- Sockets feature SUPERTORQUE™ lobular openings for greater turning power without deforming the fastener
- Packed in rugged high-density polyethylene (HDPE) cases that are strong and durable yet light in weight
- Case is shock proof at both high and low temperatures, equipped with heavy-duty metal latches and hinges
- Two-component handles are easy to grip and comfortable to carry

1/4" DRIVE

SOCKETS AND DRIVE TOOLS





JHW50611B

Features

- All tools are professional quality, made of high-grade chrome vanadium steel
- Sockets feature SUPERTORQUE™ lobular openings for greater turning power without deforming the fastener
- Packed in rugged high-density polyethylene (HDPE) cases that are strong and durable yet light in weight
- Case is shock proof at both high and low temperatures, equipped with heavy-duty metal latches and hinges
- Two-component handles are easy to grip and comfortable to carry

**95 PIECE
1/4" & 3/8" DRIVE MASTER
SOCKET AND TOOL SET**



6 & 12 Point Rugged-Case-System Tool Set, SAE

Product Code	Description
JHW50611B	95 Piece Master Socket, Wrench, and Screwdriver Set

1/4" Drive Contents Include:

1/4" Drive Tools

- 36 Tooth Quick-Release Ratchet
- 1 1/2" Extension
- 3" Extension
- Flex Handle
- Spinner Handle
- Universal Joint
- 1/4" F x 3/8" M Adapter

1/4" Drive Shallow 6-Point Sockets

- SAE Size (Inches)
- 3/16
 - 7/32
 - 1/4
 - 9/32
 - 5/16
 - 11/32
 - 3/8
 - 7/16
 - 1/2
 - 9/16

1/4" Drive Deep 6 Point Sockets

- SAE Size (Inches)
- 3/16
 - 7/32
 - 1/4
 - 9/32
 - 5/16
 - 11/32
 - 3/8
 - 7/16
 - 1/2
 - 9/16

1/4" Drive Hex Bit Sockets

Metric Size (MM)	SAE Size (Inches)
3	1/8
4	5/32
5	3/16
6	7/32
7	1/4
8	5/16

1/4" Drive Screwdriver Bit Sockets

Size	Size
5/32" Slotted Tip	#0 Phillips Tip
7/32" Slotted Tip	#1 Phillips Tip
9/32" Slotted Tip	#2 Phillips Tip

1/4" Drive Torx Bit Sockets

Size	Size
T10	T25
T15	T27
T20	T30

3/8" Drive Contents Include:

3/8" Drive Tools

- 38 Tooth Quick-Release Ratchet
- 3" Extension
- 6" Extension
- 10" Extension
- 10" Flex Handle
- Universal Joint
- Sliding T-Handle
- 3/8" F x 1/4" M Adapter
- 3/8" F x 1/2" M Adapter

3/8" Drive Shallow 6-Point Sockets

- SAE Size (Inches)
- 3/16
 - 7/16
 - 1/2
 - 9/16
 - 5/8
 - 11/16
 - 3/4
 - 13/16
 - 7/8
 - 15/16
 - 1

3/8" Drive Deep 12 Point Sockets

- SAE Size (Inches)
- 3/16
 - 7/16
 - 1/2
 - 9/16
 - 5/8
 - 11/16
 - 3/4
 - 13/16
 - 7/8
 - 15/16
 - 1

Other Contents Include:

Comfort Grip Screwdrivers

- 3/16" x 4" Slotted
- 1/4" x 4" Slotted
- #1 x 3" Phillips®
- #2 x 4" Phillips®

12 Point Combination Wrenches

- SAE Size (Inches)
- 1/4
 - 5/16
 - 3/8
 - 7/16
 - 1/2
 - 9/16
 - 5/8
 - 11/16
 - 3/4

1/4" DRIVE

SOCKETS AND DRIVE TOOLS

**89 PIECE
1/4" & 3/8" DRIVE MASTER
SOCKET AND TOOL SET**



6 & 12 Point Rugged-Case-System Tool Set, Metric

Product Code	Description
JHW50622B	89 Piece Master Socket, Wrench and Screwdriver Set

**1/4" Drive
Contents Include:**

1/4" Drive Tools

- 36 Tooth Quick-Release Ratchet
- 1 1/2" Extension
- 3" Extension
- Flex Handle
- Spinner Handle
- Universal Joint
- 1/4" F x 3/8" M Adapter

**1/4" Drive Shallow
6-Point Sockets**

Metric Size (MM)
4
5
5.5
6
7
8
9
10
11
12
13
14

**1/4" Drive
Hex Bit Sockets**

Metric Size (MM)	SAE Size (Inches)
3	1/8
4	5/32
5	3/16
6	7/32
7	1/4
8	5/16

**1/4" Drive Screwdriver
Bit Sockets**

Size	Size
5/32" Slotted Tip	#0 Phillips Tip
7/32" Slotted Tip	#1 Phillips Tip
9/32" Slotted Tip	#2 Phillips Tip

**1/4" Drive
Torx Bit Sockets**

Size	Size
T10	T25
T15	T27
T20	T30

**3/8" Drive
Contents Include:**

3/8" Drive Tools

- 38 Tooth Quick-Release Ratchet
- 3" Extension
- 6" Extension
- 10" Extension
- 10" Flex Handle
- Universal Joint
- Sliding T-Handle
- 3/8" F x 1/4" M Adapter
- 3/8" F x 1/2" M Adapter

**3/8" Drive Shallow
6-Point Sockets**

Metric Size (MM)
8
9
10
11
12
13
14
15
16
17
18
19

**3/8" Drive Deep
12-Point Sockets**

Metric Size (MM)
8
9
10
11
12
13
14
15
16
17
18
19

**Other Contents
Include:**

**Comfort Grip
Screwdrivers**

- 3/16" x 4" Slotted
- 1/4" x 4" Slotted
- #1 x 3" Phillips®
- #2 x 4" Phillips®

**12 Point Combination
Wrenches**

Metric Size (MM)
6
8
10
12
13
14
15
17
19



JHW50622B

Features

- All tools are professional quality, made of high-grade chrome vanadium steel
- Sockets feature SUPERTORQUE™ lobular openings for greater turning power without deforming the fastener
- Packed in rugged high-density polyethylene (HDPE) cases that are strong and durable yet light in weight
- Case is shock proof at both high and low temperatures, equipped with heavy-duty metal latches and hinges
- Two-component handles are easy to grip and comfortable to carry

1/4" DRIVE

SOCKETS AND
DRIVE TOOLS





JHW50602B

67 PIECE 1/4" DRIVE SOCKET AND DRIVE TOOL SET



6 Point Rugged-Case-System Tool Set, SAE and Metric

Product Code	Description
JHW50602B	67 Piece 1/4" Drive Socket Set

Contents Include:

1/4" Drive Tools		1/4" Drive Deep 6 Point Sockets		1/4" Drive Slotted Bit Sockets, SAE	
Ratchet		Metric Size (MM)	SAE Size (Inches)	Size	
Flex Handle		4	3/16	5/32	
4" Extension		5	7/32	7/32	
8" Extension		6	1/4	9/32	
18" Sliding T-handle		7	9/32		
Universal Joint		8	5/16		
Spinner Disc		9	11/32		
		10	3/8		
		11	7/16		
		12	1/2		
		13	9/16		
		14			
1/4" Drive Shallow 6-Point Sockets		1/4" Drive Hex Bit Sockets		1/4" Drive Phillips Bit Sockets, SAE	
Metric Size (MM)	SAE Size (Inches)	Metric Size (MM)	SAE Size (Inches)	Size	
4	3/16	3	1/8	#0	
5	7/32	4	5/32	#1	
5.5	1/4	5	3/16	#2	
6	9/32	6	7/32		
7	5/16	7	1/4		
8	11/32	8	5/16		
9	3/8				
10	7/16				
11	1/2				
12	9/16				
13					
14					



JHW50601B

47 PIECE 1/4" DRIVE SOCKET AND DRIVE TOOL SET



6 Point Rugged-Case-System Tool Set, SAE and Metric

Product Code	Description
JHW50601B	47 Piece Deluxe 6-Point 1/4" Drive Socket Set

Contents Include:

1/4" Drive Tools		1/4" Drive Hex Bit Sockets		Screwdriver Bit Sockets	
36 Tooth Quick-Release Ratchet		Metric Size (MM)	SAE Size (Inches)	Size	
Flex Handle		3	1/8	5/32" Slotted Tip	
1 1/2" Extension		4	5/32	7/32" Slotted Tip	
3" Extension		5	3/16	9/32" Slotted Tip	
Spinner Handle		6	7/32	#0 Phillips® Tip	
Universal Joint		7	1/4	#1 Phillips® Tip	
Ratchet Spinner		8	5/16	#2 Phillips® Tip	
1/4" Drive Shallow 6-Point Sockets					
Metric Size (MM)	SAE Size (Inches)				
4	3/16				
5	7/32				
5.5	1/4				
6	9/32				
7	5/16				
8	11/32				
9	3/8				
10	7/16				
11	1/2				
12	9/16				
13					
14					

Features

- All tools are professional quality, made of high-grade chrome vanadium steel
- Sockets feature SUPERTORQUE™ lobular openings for greater turning power without deforming the fastener
- Packed in rugged high-density polyethylene (HDPE) cases that are strong and durable yet light in weight
- Case is shock proof at both high and low temperatures, equipped with heavy-duty metal latches and hinges
- Two-component handles are easy to grip and comfortable to carry

1/4" DRIVE

SOCKETS AND DRIVE TOOLS

36 PIECE 1/4" DRIVE SOCKET AND DRIVE TOOL SET



6 Point Rugged-Case-System Tool Set, Metric

Product Code	Description
JHW50604B	36 Piece Socket Set

Contents Include:

1/4" Drive Tools	1/4" Drive Phillips® Sockets	1/4" Drive TORX® Bit Sockets
Ratchet	#1	T8
1 1/2" Extension	#2	T10
6" Extension	#3	T15
Universal Joint		T20
Sliding T-Handle	1/4" Drive Slotted Sockets	T25
Spinner Handle	Metric Size (MM)	T27
	4	T30
	5.5	
	7	
1/4" Drive Shallow 6 Point Sockets		
Metric Size (MM)	1/4" Drive Hex Bit Sockets	
4	3	
4.5	4	
5	6	
6	8	
7		
8		
9		
10		
11		
12		
13		



JHW50604B

32 PIECE 1/4" & 3/8" DRIVE BIT SOCKET SET



6 Point Compact Case Tool Set, SAE and Metric

Product Code	Description
JHW50681	32 Piece 1/4" & 3/8" Drive Bit Socket Set

Contents Include:

3/8" Drive Hex Bit Sockets		3/8" Drive Phillips® Sockets	1/4" Drive TORX® Bit Sockets
Metric Size (MM)	SAE Size (Inches)	#1	T10
4	1/8	#2	T15
5	9/64	#3	T20
6	5/32		T25
7	3/16	3/8" Drive Slotted Sockets	T27
8	7/32	SAE Size (Inches)	T30
9	1/4	1/4	
10	5/16	9/16	3/8" Drive TORX® Bit Sockets
	3/8	3/8	T40
	3/8	3/8	T45
		3/8	T47
			T50



JHW50681

Features

- All tools are professional quality, made of high-grade chrome vanadium steel
- Sockets feature SUPERTORQUE™ lobular openings for greater turning power without deforming the fastener
- Packed in rugged compact high-density polyethylene (HDPE) cases that are strong and durable yet light in weight

1/4" DRIVE

SOCKETS AND DRIVE TOOLS



JHW50661B

27 PIECE 1/4" DRIVE SOCKET AND DRIVE TOOL SET



6 Point Compact Case Tool Set, SAE and Metric

Product Code	Description
JHW50661B	27 Piece 1/4" Drive Socket and Drive Tool Set

Contents Include:

1/4" Drive Tools:		1/4" Drive Shallow 6 Point Sockets:	
5 1/4" Pear Head Ratchet	1 1/2" Extension	Metric Size (MM)	SAE Size (Inches)
6" Extension	Spinner Handle	4	3/16
Universal Joint		5	7/32
		5.5	1/4
		6	9/32
		7	5/16
		8	11/32
		9	3/8
		10	7/16
		11	1/2
		12	9/16
		13	
		14	



JHW50662B

21 PIECE 1/4" DRIVE SOCKET AND DRIVE TOOL SET



6 Point Compact Case Tool Set, SAE

Product Code	Description
JHW50662B	21 Piece 1/4" Drive Socket and Drive Tool Set

Contents Include:

1/4" Drive Tools:		1/4" Drive Shallow 6 Point Sockets	1/4" Drive Deep 6 Point Sockets
5 1/4" Pear Head Ratchet	1 1/2" Extension	SAE Size (Inches)	SAE Size (Inches)
3" Extension	6" Extension	3/16	1/4
Spinner Handle		7/32	9/32
		1/4	5/16
		9/32	11/32
		5/16	3/8
		11/32	7/16
		3/8	1/2
		7/16	
		1/2	



JHW50672A

27 PIECE 1/4" DRIVE SOCKET AND DRIVE TOOL SET



12 Point Compact Case Tool Set, SAE and Metric

Product Code	Description
JHW50672A	27 Piece 1/4" Drive Socket and Drive Tool Set

Contents Include:

1/4" Drive Tools:		1/4" Drive Shallow 12 Point Sockets	1/4" Drive Shallow 12 Point Sockets
5 1/4" Pear Head Ratchet	1 1/2" Extension	SAE Size (Inches)	Metric Size (MM)
6" Extension	Spinner Handle	3/16	4
Universal Joint		7/32	5
		1/4	6
		9/32	7
		5/16	8
		11/32	9
		3/8	10
		7/16	11
		1/2	12
		9/16	13
			14

Features

- All tools are professional quality, made of high-grade chrome vanadium steel
- Sockets feature SUPERTORQUE™ lobular openings for greater turning power without deforming the fastener
- Packed in rugged compact high-density polyethylene (HDPE) cases that are strong and durable yet light in weight

1/4" DRIVE

SOCKETS AND DRIVE TOOLS

1/4" DRIVE ENCLOSED HEAD RATCHETS

Sealed Narrow Head Design, Chrome and Black Industrial Finish

Product Code	Description	Length (Inches)	Number of Teeth
JHWM-52EHA	Chrome Finish Enclosed Head Ratchet	5 1/4	36
JHWM-52EHFA	Chrome Finish Flex Head Ratchet	7	36
JHWMB-52EHA	Black Industrial Finish Enclosed Head Ratchet	5 1/4	36
JHWM-52EHRKA	Repair Kit for Enclosed Head Ratchets		

Fed. Spec: ANSI B107.10M

Features

- Enclosed head is sealed to prevent dust, dirt, and liquids from entering head, preserving internal lubrication
- Forged one-piece ratchet provide strength and safety for industrial applications
- 36 tooth gear with 10 degree of engagement allows engagement in tight working areas
- Nickel/Chrome plating provides increase protection from rust and corrosion
- Chrome finish models feature mirror-like exterior that can be easily cleaned after each use
- Single Pawl ratchet design:
 - Designed for tighter tolerances between pawl and gear which reduces metal fatigue and slippage under load
 - Does not require as many working parts, reducing possible breakage and parts to repair
- Easy access reverse lever allows user to change working direction quickly and easily with only one hand



Made in U.S.A.



1/4" DRIVE ROUND HEAD RATCHET

High-Polished Chrome Finish

Product Code	Description	Length (Inches)	Number of Teeth
JHWM-52A	Chrome Finish Round Head Ratchet	5	40
JHWM-52ARK	Repair Kit for Round Head Ratchet		

Fed. Spec: ANSI B107.10M

Features

- Double pawl design with 40 teeth action provides a 5° ratcheting angle
- Shift lever reverses action instantly
- Knurled handle provides a non-slip grip
- Chrome plating provides increased protection from rust and corrosion



Made in U.S.A.



1/4" DRIVE

1/4" DRIVE HANDLES

High-Polished Chrome Finish

Product Code	Description	Length (Inches)
JHWM-106A	Spinner Handle	6
JHWM-15A	Speeder Handle	15 1/2
JHWM-42A	Flex Handle Breaker Bar	5 3/4
JHWM-42RK	Repair Kit for Flex Handle	

Fed. Spec: ANSI B107.10M

Features

- Chrome plating provides increased protection from rust and corrosion
- Drive handles provide extra leverage with greater strength than ratchets
- Spinner handle features 1/4" drive female handle end



Made in U.S.A.

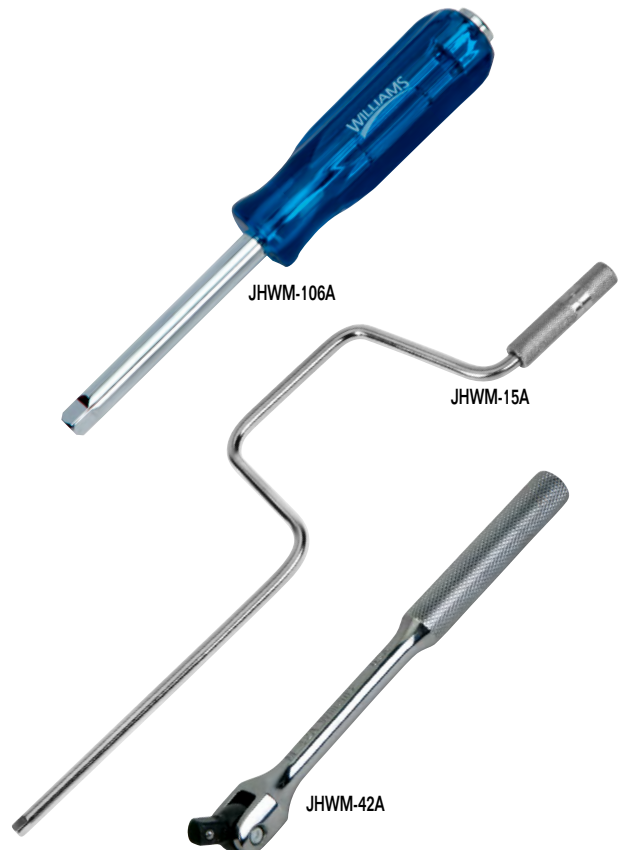

SOCKETS AND DRIVE TOOLS





1/4" DRIVE EXTENSIONS

High-Polished Chrome Finish

Product Code	Description	Length (Inches)
JHWM-102	Extension	2
JHWM-104	Extension	4
JHWM-115	Extension	6
JHWM-110	Extension	10
JHWM-124	Extension	24
JHWMFE-6	Flexible Extension	6
JHWM-140A	Universal Joint	1 7/16

Fed. Spec: ANSI B107.10M

Features

- Chrome plating provides increased protection from rust and corrosion
- Flexible extension is designed for low torque applications in limited access areas
- Ball and spring socket retention



Made in U.S.A.

1/4" DRIVE ADAPTORS

High-Polished Chrome and Black Industrial Finish

Product Code	Length (Inches)	Male End (Inches)	Female End (Inches)
Chrome Finish			
JHWMB-130	1	3/8	1/4
Black Finish			
JHWMB-130B	1	3/8	1/4
JHWMB-131BA	1 1/8	1/4	3/8

Fed. Spec: ANSI B107.10M

Features

- Ball and spring socket retention



Made in U.S.A.

1/4" DRIVE SLIDING T-HANDLE AND SPINNER HANDLE

High-Polished Chrome Finish

Product Code	Description	Length (Inches)
JHW30008	Sliding T-Handle	4 1/2
JHW30006A	Spinner Handle	6 3/8

Fed. Spec: ANSI B107.10M

Features

- Ball and spring socket retention
- High-polished chrome finish for easy cleaning
- Spinner handle features three component comfort grip handle

6 PIECE 1/4" DRIVE RATCHET AND DRIVE TOOL SET

Furnished in a Pouch

Product Code	Description
JHWDTM-6	6 Piece 1/4" Drive Ratchet and Accessory Set

Contents Include:

Product Code	Description	Product Code	Description
JHWM-52EHA	36 Tooth Quick-Release Ratchet	JHWM-42A	Flex Handle
JHWM-102	1 1/2" Extension	JHWM-106A	Spinner Handle
JHWM-115	6" Extension	JHWM-140A	Universal Joint

Features

- All tools are professional quality, made of high-grade chrome vanadium steel



JHWDTM-6

1/4" WOBBLE EXTENSIONS

High-Polished Chrome Finish

Product Code	Length (Inches)
JHWM-202	2
JHWM-203	3
JHWM-206	6
JHWM-211	11

Fed. Spec: ANSI B107.10M

Features

- Chrome plating provides increased protection from rust and corrosion
- Provides 16 degrees of additional accessibility



JHWM-203

JHWM-202

JHWM-206

JHW30013

JHW30026

JHW30027

JHW30028

1/4" DRIVE EXTENSIONS AND ACCESSORIES

High-Polished Chrome Finish

Product Code	Description	Length (Inches)
JHW30013	Holder for 1/4" Hex Screwdriver Bits	3/4
JHW30023	Locking Extension	4
JHW30024	Locking Extension	6
JHW30025	Locking Extension	10
JHW30026	Locking Extension	12
JHW30027	Locking Extension	18
JHW30028	Locking Extension	24

Fed. Spec: ANSI B107.10M

Features

- Chrome plating provides increased protection from rust and corrosion
- Ball and spring socket retention

1/4" DRIVE SHALLOW 12 POINT SOCKETS, SAE



High-Polished Chrome Finish

Product Code	A		B		C		D		E		F
	Size (Inches)	OAL (Inches)	Drive End Diameter (Inches)	Working End Diameter (Inches)	Broach Depth (Inches)	Bolt Clearance Depth (Inches)	Bolt Clearance Diameter (Inches)	Nose Length (Inches)			
JHWM-1208	1/4	7/8	15/32	3/8	7/32	17/32	7/32	7/16			
JHWM-1210	5/16	7/8	15/32	19/32	9/32	17/32	7/32	-			
JHWM-1211	11/32	7/8	1/2	1/2	9/32	17/32	11/32	-			
JHWM-1212	3/8	7/8	17/32	9/32	9/32	17/32	3/8	-			
JHWM-1214	7/16	7/8	19/32	19/32	3/8	17/32	7/16	-			
JHWM-1216	1/2	7/8	11/16	11/16	3/8	17/32	1/2	-			
JHWM-1218	9/16	29/32	3/4	3/4	3/8	17/32	7/32	-			

Fed. Spec: ANSI B107.110



JHWM-1212

JHWM-1208

JHWWSM-7RC 7 Piece 1/4" Drive Shallow 12-Point Socket Set on Clip Rail

Contents Include:

Product Code	Size (Inches)	Product Code	Size (Inches)	Product Code	Size (Inches)	Product Code	Size (Inches)
JHWM-1208	1/4	JHWM-1211	11/32	JHWM-1214	7/16	JHWM-1218	9/16
JHWM-1210	5/16	JHWM-1212	3/8	JHWM-1216	1/2		

Features

- SUPERTORQUE™ lobular openings for greater turning power without deforming the fastener
- Designed for quick engagement on both 6 and 12 point fasteners



JHWWSM-7RC

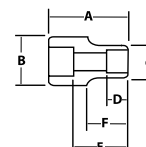

1/4" DRIVE

SOCKETS AND DRIVE TOOLS



Made in U.S.A.





1/4" DRIVE SHALLOW SOCKETS, 6 POINT, SAE

High-Polished Chrome Finish



Features

- SUPERTORQUE™ lobular openings for greater turning power without deforming the fastener
- Designed for maximum engagement on 6 point fasteners

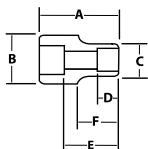

Product Code	Size (Inches)	A	B	C	D	E	F
		OAL (Inches)	Drive End Dia. (Inches)	Working End Dia. (Inches)	Broach Depth (Inches)	Bolt Clearance Depth (Inches)	Bolt Clearance Dia. (Inches)
JHWM-604	1/8	7/8	15/32	7/32	1/8	17/32	7/16
JHWM-605	5/32	7/8	15/32	7/32	1/8	17/32	7/16
JHWM-606	3/16	7/8	15/32	7/32	1/8	17/32	7/16
JHWM-607	7/32	7/8	15/32	7/32	1/8	17/32	7/16
JHWM-608	1/4	7/8	15/32	7/32	1/8	17/32	7/16
JHWM-609	9/32	7/8	15/32	7/32	1/8	17/32	7/16
JHWM-610	5/16	7/8	15/32	7/32	1/8	17/32	7/16
JHWM-611	11/32	7/8	1/2	1/2	11/32	17/32	-
JHWM-612	3/8	7/8	9/16	9/16	15/32	17/32	-
JHWM-614	7/16	7/8	5/8	5/8	15/32	17/32	-
JHWM-616	1/2	7/8	11/16	11/16	15/32	17/32	-
JHWM-618	9/16	29/32	3/4	3/4	1/2	17/32	-
JHWM-620	5/8	31/32	27/32	27/32	9/16	5/8	-

Fed. Spec: ANSI B107.110

JHWWSM-11HRC 11 Piece 1/4" Drive Shallow 6 Point Socket Set on Clip Rail

Contents Include:

Product Code	Size (Inches)	Product Code	Size (Inches)	Product Code	Size (Inches)	Product Code	Size (Inches)
JHWM-605	5/32	JHWM-608	1/4	JHWM-611	11/32	JHWM-616	1/2
JHWM-606	3/16	JHWM-609	9/32	JHWM-612	3/8	JHWM-618	9/16
JHWM-607	7/32	JHWM-610	5/16	JHWM-614	7/16		



1/4" DRIVE SHALLOW SOCKETS, 8 POINT, SAE

High-Polished Chrome Finish



Product Code	Size (Inches)	A	B	C	D	E	F
		OAL (Inches)	Drive End Dia. (Inches)	Working End Dia. (Inches)	Broach Depth (Inches)	Bolt Clearance Depth (Inches)	Bolt Clearance Dia. (Inches)
JHWM-808	1/4	7/8	15/32	7/16	1/4	17/32	7/16
JHWM-810	5/16	7/8	9/16	9/16	9/32	17/32	-
JHWM-812	3/8	7/8	21/32	21/32	5/16	17/32	-



1/4" DRIVE DEEP SOCKETS, 12 POINT, SAE

High-Polished Chrome Finish



Product Code	Size (Inches)	A	B	C	D	E	F
		OAL (Inches)	Drive End Diameter (Inches)	Working End Diameter (Inches)	Broach Depth (Inches)	Bolt Clearance Depth (Inches)	Bolt Clearance Diameter (Inches)
JHWMD-1210	5/16	2	19/32	7/16	9/32	1 1/16	9/32
JHWMD-1211	11/32	2	1/2	1/2	9/32	1 21/32	11/32
JHWMD-1212	3/8	2	17/32	17/32	9/32	1 21/32	3/8
JHWMD-1214	7/16	2	19/32	19/32	3/8	1 21/32	13/32
JHWMD-1216	1/2	2	11/16	11/16	3/8	1 21/32	15/32
JHWMD-1218	9/16	2	3/4	3/4	3/8	1 21/32	17/32

Fed. Spec: ANSI B107.110

JHWWSMD-6RC 6 Piece 1/4" Drive Deep 12 Point Socket Set on Clip Rail

Contents Include:

Product Code	Size (Inches)	Product Code	Size (Inches)	Product Code	Size (Inches)
JHWMD-1210	5/16	JHWMD-1212	3/8	JHWMD-1216	1/2
JHWMD-1211	11/32	JHWMD-1214	7/16	JHWMD-1218	9/16

JHWWSM-20RC 25 Piece 1/4" Drive Shallow & Deep Sockets on Clip Rails

Contents Include:

12-Point Deep Sockets		12-Point Shallow Sockets	
Product Code	Size (Inches)	Product Code	Size (Inches)
JHW30406	3/16	JHW30206	3/16
JHW30407	7/32	JHW30207	7/32
JHW30408	1/4	JHWM-1208	1/4
JHW30409	9/32	JHW30209	9/32
JHWMD-1210	5/16	JHWM-1210	5/16
JHWMD-1211	11/32	JHWM-1211	11/32
JHWMD-1212	3/8	JHWM-1212	3/8
JHWMD-1214	7/16	JHWM-1214	7/16
JHWMD-1216	1/2	JHWM-1216	1/2
JHWMD-1218	9/16	JHWM-1218	9/16



1/4" DRIVE

SOCKETS AND DRIVE TOOLS



1/4" DRIVE DEEP SOCKETS, 6 POINT, SAE

High-Polished Chrome Finish

Product Code	Size (Inches)	A OAL (Inches)	B Drive End Diameter (Inches)	C Working End Diameter (Inches)	D Broach Depth (Inches)	Bolt Clearance Diameter (Inches)	F Nose Length (Inches)
JHWMD-605	5/32	2	15/32	9/32	5/32	5/32	1 9/16
JHWMD-606	3/16	2	15/32	9/16	9/16	3/16	1 9/16
JHWMD-607	7/32	2	15/32	1 1/32	7/32	7/32	1 9/16
JHWMD-608	1/4	2	15/32	3/8	7/32	7/32	1 9/16
JHWMD-609	9/32	2	15/32	13/32	1/4	9/32	1 9/16
JHWMD-610	5/16	2	15/32	7/16	9/32	9/32	1 9/16
JHWMD-611	11/32	2	1/2	1/2	9/32	11/32	-
JHWMD-612	3/8	2	17/32	17/32	9/32	3/8	-
JHWMD-614	7/16	2	19/32	19/32	3/8	13/32	-
JHWMD-616	1/2	2	1 1/16	1 1/16	3/8	15/32	-
JHWMD-618	9/16	2	3/4	3/4	3/8	17/32	-

Fed. Spec: ANSI B107.110



JHWMD-605 JHWMD-618

JHWSMD10HRC 10 Piece 1/4" Drive Deep 6 Point Socket Set on Clip Rail

Contents Include:

Product Code	Size (Inches)	Product Code	Size (Inches)	Product Code	Size (Inches)	Product Code	Size (Inches)
JHWMD-606	3/16	JHWMD-609	9/32	JHWMD-612	3/8	JHWMD-618	9/16
JHWMD-607	7/32	JHWMD-610	5/16	JHWMD-614	7/16		
JHWMD-608	1/4	JHWMD-611	11/32	JHWMD-616	1/2		



JHWSMD10HRC

Features

- SUPERTORQUE™ lobular openings for greater turning power without deforming the fastener
- Designed for maximum engagement on 6 point fasteners



Made in U.S.A.

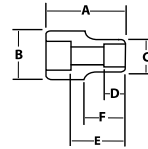

1/4" DRIVE SHALLOW SOCKETS, 6 POINT, METRIC

High-Polished Chrome Finish

Product Code	Size (MM)	A OAL (Inches)	B Drive End Diameter (Inches)	C Working End Diameter (Inches)	D Broach Depth (Inches)	E Bolt Clearance Depth (Inches)	Bolt Clearance Diameter (Inches)	F Nose Length (Inches)
JHWMM-604	4	7/8	15/32	9/32	3/16	17/32	5/32	7/16
JHWMM-605	5	7/8	15/32	9/16	3/16	17/32	5/32	7/16
JHWMM-605.5	5.5	7/8	15/32	11/32	3/16	17/32	7/32	7/16
JHWMM-606	6	7/8	15/32	3/8	7/32	17/32	7/32	7/16
JHWMM-607	7	7/8	15/32	13/32	1/4	17/32	1/4	7/16
JHWMM-608	8	7/8	15/32	15/32	9/32	17/32	1/4	7/16
JHWMM-609	9	7/8	1/2	1/2	1/2	17/32	5/16	-
JHWMM-610	10	7/8	9/16	9/16	1/2	17/32	3/8	-
JHWMM-611	11	7/8	19/32	19/32	1/2	17/32	13/32	-
JHWMM-612	12	7/8	21/32	21/32	1/2	17/32	7/16	-
JHWMM-613	13	7/8	23/32	23/32	15/32	17/32	15/32	-
JHWMM-614	14	29/32	3/4	3/4	1/2	17/32	17/32	-

Fed. Spec: ANSI B107.110



JHWMM-608 JHWMM-604

JHWMSM-12HRC 12 Piece 1/4" Drive Shallow 6 Point Socket Set on Clip Rail

Contents Include:

Product Code	Size (MM)	Product Code	Size (MM)	Product Code	Size (MM)	Product Code	Size (MM)
JHWMM-604	4	JHWMM-606	6	JHWMM-609	9	JHWMM-612	12
JHWMM-605	5	JHWMM-607	7	JHWMM-610	10	JHWMM-613	13
JHWMM-605.5	5 1/2	JHWMM-608	8	JHWMM-611	11	JHWMM-614	14



JHWMSM-12HRC

Features

- SUPERTORQUE™ lobular openings for greater turning power without deforming the fastener
- Designed for maximum engagement on 6 point fasteners



Made in U.S.A.

1/4" DRIVE

SOCKETS AND DRIVE TOOLS





1/4" DRIVE SHALLOW SOCKETS, 12 POINT, METRIC

High-Polished Chrome Finish



JHW30608

JHW30604

Product Code	Size (MM)	A		B		C		D		E		F
		OAL (Inches)	Drive End Diameter (Inches)	Working End Diameter (Inches)	Broach Depth (Inches)	Bolt Clearance Depth (Inches)	Bolt Clearance Diameter (Inches)	Nose Length (Inches)				
JHW30604A	4	1	15/32	1/4	1/4	19/32	1/2					
JHW30605A	5	1	15/32	5/16	5/16	19/32	1/2					
JHW30699A	5.5	1	15/32	11/32	15/32	19/32	1/2					
JHW30606A	6	1	15/32	11/32	5/16	19/32	1/2					
JHW30607A	7	1	15/32	7/16	5/16	15/32	1/2					
JHW30608A	8	1	15/32	15/32	3/8	1/2	-					
JHW30609A	9	1	17/32	17/32	3/8	21/32	-					
JHW30610A	10	1	19/32	19/32	1/2	7/8	-					
JHW30611A	11	1	5/8	5/8	17/32	7/8	-					
JHW30612A	12	1	11/16	11/16	1/2	7/8	-					
JHW30613A	13	1	23/32	23/32	1/2	7/8	-					
JHW30614A	14	1	3/4	3/4	1/2	7/8	-					

Fed. Spec: ANSI B107.110

JHW30925 12 Piece 1/4" Drive Shallow 12 Point Socket Set on Clip Rail

Contents Include:



JHW30925

Product Code	Size (MM)	Product Code	Size (MM)	Product Code	Size (MM)	Product Code	Size (MM)
JHW30604	4	JHW30606	6	JHW30609	9	JHW30612	12
JHW30605	5	JHW30607	7	JHW30610	10	JHW30613	13
JHW30699	5.5	JHW30608	8	JHW30611	11	JHW30614	14

Features

- SUPERTORQUE™ lobular openings for greater turning power without deforming the fastener
- Designed for maximum engagement on 12 point fasteners

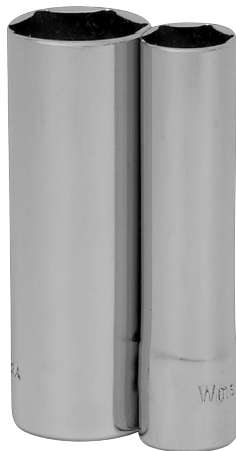

JHWMMD-614

JHWMMD-606



1/4" DRIVE DEEP SOCKETS, 6 POINT, METRIC

High-Polished Chrome Finish

Product Code	Size (MM)	A		B		C		D		E		F
		OAL (Inches)	Drive End Diameter (Inches)	Working End Diameter (Inches)	Broach Depth (Inches)	Bolt Clearance Depth (Inches)	Bolt Clearance Diameter (Inches)	Nose Length (Inches)				
JHWMMD-604	4	2	15/32	9/32	3/16	1 21/32	1/8	1 9/16				
JHWMMD-605	5	2	15/32	5/16	3/16	1 21/32	3/32	1 9/16				
JHWMMD-605.5	5.5	2	15/32	5/16	7/32	1 21/32	7/32	1 9/16				
JHWMMD-606	6	2	15/32	3/8	7/32	1 21/32	7/32	1 9/16				
JHWMMD-607	7	2	15/32	13/32	1/4	1 21/32	1/4	1 9/16				
JHWMMD-608	8	2	15/32	15/32	9/32	1 21/32	1/4	1 9/16				
JHWMMD-609	9	2	1/2	1/2	9/32	1 21/32	5/16	-				
JHWMMD-610	10	2	9/16	9/16	9/32	1 21/32	3/8	-				
JHWMMD-611	11	2	19/32	19/32	3/8	1 21/32	13/32	-				
JHWMMD-612	12	2	21/32	21/32	3/8	1 21/32	7/16	-				
JHWMMD-613	13	2	23/32	23/32	3/8	1 21/32	15/32	-				
JHWMMD-614	14	2	3/4	3/4	7/16	1 21/32	17/32	-				

Fed. Spec: ANSI B107.110

JHWMSMD12HRC 12 Piece 1/4" Drive Deep 6 Point Socket Set on Clip Rail

Contents Include:



JHWMSMD12HRC

Product Code	Size (MM)	Product Code	Size (MM)	Product Code	Size (MM)	Product Code	Size (MM)
JHWMMD-604	4	JHWMMD-606	6	JHWMMD-609	9	JHWMMD-612	12
JHWMMD-605	5	JHWMMD-607	7	JHWMMD-610	10	JHWMMD-613	13
JHWMMD-605.5	5.5	JHWMMD-608	8	JHWMMD-611	11	JHWMMD-614	14

Features

- SUPERTORQUE™ lobular openings for greater turning power without deforming the fastener
- Designed for maximum engagement on 6 point fasteners



Made in U.S.A.

1/4" DRIVE
SOCKETS AND
DRIVE TOOLS



1/4" DRIVE DEEP SOCKETS, 12 POINT, METRIC

High-Polished Chrome Finish

Product Code	Size (MM)	A		B		C		D		E		F	
		OAL (Inches)	Drive End Diameter (Inches)	Working End Diameter (Inches)	Broach Depth (Inches)	Bolt Clearance Depth (Inches)	Bolt Clearance Diameter (Inches)	Nose Length (Inches)					
JHW30804	4	2	15/32	9/32	3/16	1 21/32	1/8	15/16					
JHW30805	5	2	15/32	5/16	3/16	1 21/32	5/32	15/16					
JHW30855	5.5	2	15/32	5/16	7/32	1 21/32	7/32	15/16					
JHW30806	6	2	15/32	3/8	7/32	1 21/32	7/32	15/16					
JHW30807	7	2	15/32	13/32	1/4	1 21/32	1/4	15/16					
JHW30808	8	2	15/32	15/32	9/32	1 21/32	1/4	15/16					
JHW30809	9	2	1/2	1/2	9/32	1 21/32	5/16	-					
JHW30810	10	2	9/16	9/16	9/32	1 21/32	3/8	-					
JHW30811	11	2	19/32	19/32	3/8	1 21/32	13/32	-					
JHW30812	12	2	21/32	21/32	3/8	1 21/32	7/16	-					
JHW30813	13	2	23/32	23/32	3/8	1 21/32	15/32	-					
JHW30814	14	2	3/4	3/4	7/16	1 21/32	17/32	-					

Fed. Spec: ANSI B107.110



JHW30808 JHW30804

JHW30941 12 Piece 1/4" Drive Deep 12 Point Socket Set on Clip Rail

Contents Include:

Product Code	Size (MM)	Product Code	Size (MM)	Product Code	Size (MM)	Product Code	Size (MM)
JHW30804	4	JHW30806	6	JHW30809	9	JHW30812	12
JHW30805	5	JHW30807	7	JHW30810	10	JHW30813	13
JHW30855	5.5	JHW30808	8	JHW30811	11	JHW30814	14



JHW30941

Features

- SUPERTORQUE™ lobular openings for greater turning power without deforming the fastener
- Designed for maximum engagement on both 6 and 12 point fasteners

1/4" DRIVE STANDARD LENGTH HEX BIT SOCKETS, SAE



High-Polished Chrome Finish

Product Code	Size (Inches)	Socket Length (Inches)	Socket Outside Diameter (Inches)	Overall Length (Inches)	Replacement Bit Product Code
JHWMA-050A	.050	7/8	15/32	1 1/2	JHWBITH05001
JHWMA-2A	1/16	7/8	15/32	1 1/2	JHWBITH0201
JHWMA-2 1/2A	5/64	7/8	15/32	1 1/2	JHWBITH2.501
JHWMA-3A	3/32	7/8	15/32	1 1/2	JHWBITH0301
JHWMA-3 1/2A	7/64	7/8	15/32	1 1/2	JHWBITH3.501
JHWMA-4A	1/8	7/8	15/32	1 1/2	JHWBITH0401
JHWMA-4 1/2A	9/64	7/8	15/32	1 1/2	JHWBITH4.501
JHWMA-5A	5/32	7/8	15/32	1 1/2	JHWBITH0501
JHWMA-6A	3/16	7/8	15/32	1 1/2	JHWBITH0601
JHWMA-7A	7/32	7/8	15/32	1 1/2	JHWBITH0701
JHWMA-8A	1/4	7/8	15/32	1 1/2	JHWBITH0801
JHWMA-10A	5/16	7/8	15/32	1 1/2	JHWBITH1001



JHWMA-4A

JHWWSM-11TRC 11 Piece Hex Bit Socket Set on Clip Rail

Contents Include:

Product Code	Size (Inches)	Product Code	Size (Inches)	Product Code	Size (Inches)
JHWMA-2A	1/16	JHWMA-4A	1/8	JHWMA-7A	7/32
JHWMA-2 1/2A	5/64	JHWMA-4 1/2A	9/64	JHWMA-8A	1/4
JHWMA-3A	3/32	JHWMA-5A	5/32	JHWMA-10A	5/16
JHWMA-3 1/2A	7/64	JHWMA-6A	3/16		



JHWWSM-11TRC

Features

- High-polished chrome finish socket cleans easily
- Two piece design allows bits to be replaced easily



1/4" DRIVE

SOCKETS AND DRIVE TOOLS





1/4" DRIVE LONG HEX BIT SOCKETS, SAE

High-Polished Chrome Finish

Product Code	Size (Inches)	Socket Length (Inches)	Socket Outside Diameter (Inches)	Overall Length (Inches)	Replacement Bit Product Code
JHWMA-3LA	3/32	7/8	15/32	3	JHWBITH0302
JHWMA-3 1/2 LA	7/64	7/8	15/32	3	JHWBITH3.502
JHWMA-4LA	1/8	7/8	15/32	3	JHWBITH0402
JHWMA-4 1/2 LA	9/64	7/8	15/32	3	JHWBITH4.502
JHWMA-5LA	5/32	7/8	15/32	3	JHWBITH0502
JHWMA-6LA	3/16	7/8	15/32	3	JHWBITH0602
JHWMA-7LA	7/32	7/8	15/32	3	JHWBITH0702
JHWMA-8LA	1/4	7/8	15/32	3	JHWBITH0802
JHWMA-10LA	5/16	7/8	15/32	3	JHWBITH1002

JHWMA-5LA



JHWSMS-9LRC

JHWSMS-9LRC 9 Piece Long Hex Bit Socket Set on Clip Rail

Contents Include:

Product Code	Size (Inches)	Product Code	Size (Inches)	Product Code	Size (Inches)
JHWMA-3LA	3/32	JHWMA-4 1/2 LA	9/64	JHWMA-7LA	7/32
JHWMA-3 1/2 LA	7/64	JHWMA-5LA	5/32	JHWMA-8LA	1/4
JHWMA-4LA	1/8	JHWMA-6LA	3/16	JHWMA-10LA	5/16

Features

- High-polished chrome finish socket cleans easily
- Two piece design allows bits to be replaced easily



1/4" DRIVE STANDARD LENGTH HEX BIT SOCKETS, METRIC



High-Polished Chrome Finish

Product Code	Size (MM)	Socket Length (Inches)	Socket Outside Diameter (Inches)	Overall Length (Inches)	Bit Length (Inches)
JHW35070	3	1 1/16	15/32	1 13/32	5/8
JHW35071	4	1 3/16	15/32	1 13/32	5/8
JHW35072	5	1 3/16	15/32	1 13/32	5/8
JHW35073	6	1 3/16	15/32	1 13/32	5/8
JHW35074	7	1 3/16	15/32	1 13/32	5/8
JHW35075	8	1 3/16	15/32	1 13/32	5/8

JHW35070



JHW30904

JHW30904 6 Piece Hex Bit Socket Set on Clip Rail

Contents Include:

Product Code	Size (MM)	Product Code	Size (MM)	Product Code	Size (MM)
JHW35070	3	JHW35072	5	JHW35074	7
JHW35071	4	JHW35073	6	JHW35075	8

Features

- High-polished chrome finish socket cleans easily

1/4" DRIVE BALL TIP HEX BIT SOCKETS, SAE



High-Polished Chrome Finish

Product Code	Size (Inches)	Socket Length (Inches)	Socket Outside Diameter (Inches)	Overall Length (Inches)	Replacement Bit Product Code (Inches)
JHWMA-3HBA	3/32	7/8	15/32	1 1/2	JHWBITH0301
JHWMA-4HBA	1/8	7/8	15/32	1 1/2	JHWBITH0401
JHWMA4 1/2 HBA	9/64	7/8	15/32	1 1/2	JHWBITH4.501
JHWMA-5HBA	5/32	7/8	15/32	1 1/2	JHWBITH0501
JHWMA-6HBA	3/16	7/8	15/32	1 1/2	JHWBITH0601
JHWMA-7HBA	7/32	7/8	15/32	1 1/2	JHWBITH0701
JHWMA-8HBA	1/4	7/8	15/32	1 1/2	JHWBITH0801

JHWMA-3HBA



JHWSM-7HBA

JHWSM-7HBA 7 Piece Ball Tip Hex Bit Socket Set on Clip Rail

Contents Include:

Product Code	Size (Inches)	Product Code	Size (Inches)	Product Code	Size (Inches)
JHWMA-3HBA	3/32	JHWMA-5HBA	5/32	JHWMA-8HBA	1/4
JHWMA-4HBA	1/8	JHWMA-6HBA	3/16		
JHWMA4 1/2 HBA	9/64	JHWMA-7HBA	7/32		

Features

- High-polished chrome finish socket cleans easily
- Two piece design allows bits to be replaced easily



1/4" DRIVE

SOCKETS AND
DRIVE TOOLS

1/4" DRIVE STUBBY HEX BIT SOCKETS, SAE



High-Polished Chrome Finish

Product Code	Size (Inches)	Socket Length (Inches)	Socket Outside Diameter (Inches)	Overall Length (Inches)	Replacement Bit Product Code
JHWMA-4SA	1/8	7/8	15/32	1 1/16	JHWTMAXS4E2
JHWMA-4.5SA	9/64	7/8	15/32	1 1/16	JHWTMAXS4S5E2
JHWMA-5SA	5/32	7/8	15/32	1 1/16	JHWTMAXS5E2
JHWMA-6SA	3/16	7/8	15/32	1 1/16	JHWTMAXS6E2

JHWWSM-4TRC 4 Piece Stubby Hex Bit Socket Set on Clip Rail

Product Code	Size (Inches)	Product Code	Size (Inches)
JHWMA-4SA	1/8	JHWMA-5SA	5/32
JHWMA-4.5SA	9/64	JHWMA-6SA	3/16

Features

- High-polished chrome finish socket cleans easily
- Two piece design allows bits to be replaced easily
- Extra-short bits provide access in confined areas



1/4" DRIVE TORX® BIT SOCKETS



High-Polished Chrome Finish

Product Code	Torx® Size	Socket Length (Inches)	Socket Outside Diameter (Inches)	Overall Length (Inches)	Bit Length (Inches)
JHW35079	T8	13/16	1/2	1 13/32	5/8
JHW35080	T10	13/16	1/2	1 13/32	5/8
JHW35081	T15	13/16	1/2	1 13/32	5/8
JHW35082	T20	13/16	1/2	1 13/32	5/8
JHW35083	T25	13/16	1/2	1 13/32	5/8
JHW35084	T27	13/16	1/2	1 13/32	5/8
JHW35085	T30	13/16	1/2	1 13/32	5/8

JHW30908 6 Piece Torx® Bit Socket Set on Clip Rail

Product Code	Torx® Size	Product Code	Torx® Size	Product Code	Torx® Size
JHW35080	T10	JHW35082	T20	JHW35084	T27
JHW35081	T15	JHW35083	T25	JHW35085	T30

Features

- High-polished chrome finish socket cleans easily

1/4" DRIVE SCREWDRIVER BIT SOCKETS

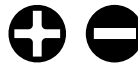

High-Polished Chrome Finish, Phillips® and Slotted

Product Code	Tip Size (Inches)	Socket Length (Inches)	Socket Outside Diameter (Inches)	Overall Length (Inches)	Bit Length (Inches)
Slotted Bits:					
JHW35040	5/32	13/16	15/32	1 13/32	5/8
JHW35041	7/32	13/16	15/32	1 13/32	5/8
JHW35042	9/32	13/16	15/32	1 13/32	5/8
Phillips® Bits:					
JHW35050	#0	13/16	15/32	1 13/32	5/8
JHW35051	#1	13/16	15/32	1 13/32	5/8
JHW35052	#2	13/16	15/32	1 13/32	5/8
JHW35053	#3	13/16	15/32	1 13/32	5/8

JHW30906 6 Piece Screwdriver Bit Socket Set on Clip Rail

Product Code	Tip Size (Inches)	Product Code	Tip Size (Inches)	Product Code	Tip Size
JHW35040	5/32	JHW35042	9/32	JHW35051	#1
JHW35041	7/32	JHW35050	#0	JHW35052	#2

Features

- High-polished chrome finish socket cleans easily



JHWMA-4SA



JHWWSM-4TRC



JHW35080



JHW30908



JHW30906

1/4" DRIVE

SOCKETS AND DRIVE TOOLS



56 PIECE 3/8" DRIVE SOCKET AND DRIVE TOOL SET



8 & 12 Point SAE, with Metal Box

Product Code	Description
JHWWSB-56FTB	56 Piece Tool Set with TB-104 Metal Tool Box (Keep-Safe-Foam is not included)
JHWWSB-56F	56 Piece Tool Set Only Packed in Keep-Safe-Foam System

Contents Include:

Drive Tools:		Drive Tools:	
Product Code	Description	Product Code	Description
JHWB-52EHA	8" Enclosed Head Ratchet	JHWB-40B	8 9/16" Flex Handle
JHWB-108	3" Extension	JHWB-140A	Universal Joint
JHWB-110	6" Extension	JHWB-20A	Sliding T-Handle
JHWB-115	11" Extension		

Shallow 12-Point Sockets		Deep 12-Point Sockets	
Product Code	Size (Inches)	Product Code	Size (Inches)
JHWB-1208	1/4	JHWBD-1212	3/8
JHWB-1210	5/16	JHWBD-1214	7/16
JHWB-1212	3/8	JHWBD-1216	1/2
JHWB-1214	7/16	JHWBD-1218	9/16
JHWB-1216	1/2	JHWBD-1220	5/8
JHWB-1218	9/16	JHWBD-1222	11/16
JHWB-1220	5/8	JHWBD-1224	3/4
JHWB-1222	11/16	JHWBD-1226	13/16
JHWB-1224	3/4	JHWBD-1228	7/8
JHWB-1226	13/16	JHWBD-1230	15/16
JHWB-1228	7/8	JHWBD-1232	1
JHWB-1230	15/16		
JHWB-1232	1		

Shallow 8-Point Sockets		Shallow 12-Point Universal Sockets	
Product Code	Size (Inches)	Product Code	Size (Inches)
JHWBD-808	1/4	JHWBU-1212	3/8
JHWBD-810	5/16	JHWBU-1214	7/16
JHWBD-812	3/8	JHWBU-1216	1/2
JHWBD-814	7/16	JHWBU-1218	9/16
JHWBD-816	1/2	JHWBU-1220	5/8
		JHWBU-1222	11/16
		JHWBU-1224	3/4

Standard Hex Bit Sockets		Screwdriver Bit Sockets	
Product Code	Size (Inches)	Product Code	Size
JHWBA-4A	1/8	JHWBA-7A-2S	7/32" x .040"
JHWBA-5A	5/32	JHWBA-10A-3S	9/32" x .045"
JHWBA-6A	3/16	JHWBA-10A-4S	5/16" x .055"
JHWBA-7A	7/32	JHWBA-7A-2P	#2
JHWBA-8A	1/4	JHWBA-10A-3P	#3
JHWBA-10A	5/16	JHWBA-12A-4P	#4
JHWBA-12A	3/8		

Features

- All tools are professional quality, made of high-grade chrome vanadium steel
- Sockets feature SUPERTORQUE™ lobular openings for greater turning power without deforming the fastener
- Metal tool box made for years of rugged use



JHWWSB-56FTB



3/8" DRIVE

SOCKETS AND DRIVE TOOLS

32 PIECE 3/8" DRIVE SOCKET AND DRIVE TOOL SET



8 & 12 Point SAE, Packed in Exclusive Keep-Safe-Foam System with Metal Box

Product Code	Description
JHWSB-32FTB	32 Piece Tool Set with TB-104 Metal Tool Box
JHWSB-32F	32 Piece Tool Set Only - Packed in Keep Safe Foam System

Contents Include:

Drive Tools:		Drive Tools:	
Product Code	Description	Product Code	Description
JHWB-52EHA	8" Enclosed Head Ratchet	JHWB-115	11" Extension
JHWB-108	3" Extension	JHWB-40B	8 9/16" Flex Handle
JHWB-110	6" Extension	JHWB-140A	Universal Joint

Shallow 12-Point Sockets		Deep 12-Point Sockets	
Product Code	Size (Inches)	Product Code	Size (Inches)
JHWB-1212	3/8	JHWBD-1212	3/8
JHWB-1214	7/16	JHWBD-1214	7/16
JHWB-1216	1/2	JHWBD-1216	1/2
JHWB-1218	9/16	JHWBD-1218	9/16
JHWB-1220	5/8	JHWBD-1220	5/8
JHWB-1222	11/16	JHWBD-1222	11/16
JHWB-1224	3/4	JHWBD-1224	3/4
JHWB-1226	13/16	JHWBD-1226	13/16
JHWB-1228	7/8	JHWBD-1228	7/8

Shallow 8-Point Sockets		Shallow 12-Point Universal Sockets	
Product Code	Size (Inches)	Product Code	Size (Inches)
JHWBD-808	1/4	JHWBU-1212	3/8
JHWBD-810	5/16	JHWBU-1214	7/16
JHWBD-812	3/8	JHWBU-1216	1/2
		JHWBU-1218	9/16
		JHWBU-1220	5/8

Features

- Keep-Safe-Foam system keeps tools organized and helps prevent loss
- All tools are professional quality, made of high-grade chrome vanadium steel
- Sockets feature SUPERTORQUE™ lobular openings for greater turning power without deforming the fastener
- Metal tool box made for years of rugged use



3/8" DRIVE

SOCKETS AND DRIVE TOOLS



28 PIECE 3/8" DRIVE SOCKET AND DRIVE TOOL SET



12 Point SAE, Packed in Exclusive Keep-Safe-Foam System with Metal Box

Product Code	Description
JHWWSB-28FTB	28 Piece Tool Set with TB-104 Metal Tool Box
JHWWSB-28F	28 Piece Tool Set Only - Packed in Keep Safe Foam System

Contents Include:

Drive Tools:		Drive Tools:	
Product Code	Description	Product Code	Description
JHWB-52EHA	8" Enclosed Head Ratchet	JHWB-40B	8 9/16" Flex Handle
JHWB-108	3" Extension	JHWB-140A	Universal Joint
JHWB-110	6" Extension		

Shallow 12-Point Sockets

Product Code	Size (Inches)
JHWB-1208	1/4
JHWB-1210	5/16
JHWB-1211	11/32
JHWB-1212	3/8
JHWB-1214	7/16
JHWB-1216	1/2
JHWB-1218	9/16
JHWB-1220	5/8
JHWB-1222	11/16
JHWB-1224	3/4
JHWB-1226	13/16
JHWB-1228	7/8
JHWB-1230	15/16
JHWB-1232	1

Deep 12-Point Sockets

Product Code	Size (Inches)
JHWBD-1212	3/8
JHWBD-1214	7/16
JHWBD-1216	1/2
JHWBD-1218	9/16
JHWBD-1220	5/8
JHWBD-1222	11/16
JHWBD-1224	3/4
JHWBD-1226	13/16
JHWBD-1228	7/8



JHWWSB-28FTB

Features

- Keep-Safe-Foam system keeps tools organized and helps prevent loss
- All tools are professional quality, made of high-grade chrome vanadium steel
- Sockets feature SUPERTORQUE™ lobular openings for greater turning power without deforming the fastener
- Metal tool box made for years of rugged use



23 PIECE 3/8" DRIVE SOCKET AND DRIVE TOOL SET



6 Point SAE, Packed in Exclusive Keep-Safe-Foam System with Metal Box

Product Code	Description
JHWWSB23HFTB	23 Piece Tool Set with TB-102 Metal Tool Box
JHWWSB-23HF	23 Piece Tool Set Only - Packed in Keep Safe Foam System

Contents Include:

Drive Tools:		Drive Tools:	
Product Code	Description	Product Code	Description
JHWB-52EHA	8" Enclosed Head Ratchet	JHWB-40B	8 9/16" Flex Handle
JHWB-108	3" Extension	JHWB-140A	Universal Joint
JHWB-110	6" Extension		

Shallow 6-Point Sockets

Product Code	Size (Inches)
JHWB-612	3/8
JHWB-614	7/16
JHWB-616	1/2
JHWB-618	9/16
JHWB-620	5/8
JHWB-622	11/16
JHWB-624	3/4
JHWB-626	13/16
JHWB-628	7/8

Deep 6-Point Sockets

Product Code	Size (Inches)
JHWBD-612	3/8
JHWBD-614	7/16
JHWBD-616	1/2
JHWBD-618	9/16
JHWBD-620	5/8
JHWBD-622	11/16
JHWBD-624	3/4
JHWBD-626	13/16
JHWBD-628	7/8



JHWWSB23HFTB

Features

- Keep-Safe-Foam system keeps tools organized and helps prevent loss
- All tools are professional quality, made of high-grade chrome vanadium steel
- Sockets feature SUPERTORQUE™ lobular openings for greater turning power without deforming the fastener
- Metal tool box made for years of rugged use



3/8" DRIVE

SOCKETS AND DRIVE TOOLS

23 PIECE 3/8" DRIVE SOCKET AND DRIVE TOOL SET



12 Point SAE, Packed in Exclusive Keep-Safe-Foam System with Metal Box

Product Code	Description
JHWWSB-23FTB	23 Piece Tool Set with TB-102 Metal Tool Box
JHWWSB-23F	23 Piece Tool Set Only - Packed in Keep Safe Foam System

Contents Include:

Drive Tools:		Drive Tools:	
Product Code	Description	Product Code	Description
JHWB-52EHA	8" Enclosed Head Ratchet	JHWB-40B	8 9/16" Flex Handle
JHWB-108	3" Extension	JHWB-140A	Universal Joint
JHWB-110	6" Extension		

Shallow 12-Point Sockets		Deep 12-Point Sockets	
Product Code	Size (Inches)	Product Code	Size (Inches)
JHWB-1212	3/8	JHWBD-1212	3/8
JHWB-1214	7/16	JHWBD-1214	7/16
JHWB-1216	1/2	JHWBD-1216	1/2
JHWB-1218	9/16	JHWBD-1218	9/16
JHWB-1220	5/8	JHWBD-1220	5/8
JHWB-1222	11/16	JHWBD-1222	11/16
JHWB-1224	3/4	JHWBD-1224	3/4
JHWB-1226	13/16	JHWBD-1226	13/16
JHWB-1228	7/8	JHWBD-1228	7/8

Features

- Keep-Safe-Foam system keeps tools organized and helps prevent loss
- All tools are professional quality, made of high-grade chrome vanadium steel
- Sockets feature SUPERTORQUE™ lobular openings for greater turning power without deforming the fastener
- Metal tool box made for years of rugged use



JHWWSB-23FTB

15 PIECE 3/8" DRIVE SOCKET AND DRIVE TOOL SET



12 Point SAE, Packed in Exclusive Keep-Safe-Foam System with Metal Box

Product Code	Description
JHWWSB-15FTB	15 Piece Tool Set with TB-102 Metal Tool Box
JHWWSB-15F	15 Piece Tool Set Only - Packed in Keep Safe Foam System

Contents Include:

Drive Tools:		Shallow 12-Point Sockets	
Product Code	Description	Product Code	Size (Inches)
JHWB-52EHA	8" Enclosed Head Ratchet	JHWB-1212	3/8
JHWB-108	3" Extension	JHWB-1214	7/16
JHWB-110	6" Extension	JHWB-1216	1/2
JHWB-115	11" Extension	JHWB-1218	9/16
JHWB-40B	8 9/16" Flex Handle	JHWB-1220	5/8
JHWB-140A	Universal Joint	JHWB-1222	11/16
		JHWB-1224	3/4
		JHWB-1226	13/16
		JHWB-1228	7/8

Features

- Keep-Safe-Foam system keeps tools organized and helps prevent loss
- All tools are professional quality, made of high-grade chrome vanadium steel
- Sockets feature SUPERTORQUE™ lobular openings for greater turning power without deforming the fastener
- Metal tool box made for years of rugged use



JHWWSB-15FTB

3/8" DRIVE

SOCKETS AND DRIVE TOOLS



12 PIECE 3/8" DRIVE SOCKET AND DRIVE TOOL SET



6 Point SAE, Packed in Exclusive Keep-Safe-Foam System with Metal Box

Product Code	Description
JHWWSB12HFTB	12 Piece Tool Set with TB-101 Metal Tool Box
JHWWSB-12HF	12 Piece Tool Set Only - Packed in Keep Safe Foam System

Contents Include:

Drive Tools:		Shallow 12-Point Sockets	
Product Code	Description	Product Code	Size (Inches)
JHWB-52EHA	8" Enclosed Head Ratchet	JHWB-612	3/8
JHWB-108	3" Extension	JHWB-614	7/16
JHWB-110	6" Extension	JHWB-616	1/2
		JHWB-618	9/16
		JHWB-620	5/8
		JHWB-622	11/16
		JHWB-624	3/4
		JHWB-626	13/16
		JHWB-628	7/8

Features

- Keep-Safe-Foam system keeps tools organized and helps prevent loss
- All tools are professional quality, made of high-grade chrome vanadium steel
- Sockets feature SUPERTORQUE™ lobular openings for greater turning power without deforming the fastener
- Metal tool box made for years of rugged use



JHWWSB12HFTB

29 PIECE 3/8" DRIVE SOCKET AND DRIVE TOOL SET



6 & 12 Point SAE & Metric, Packed in Exclusive Keep-Safe-Foam System with Metal Box

Product Code	Description
JHWW SMB29FTB	29 Piece Tool Set with TB-103 Metal Tool Box
JHWW SMB-29F	29 Piece Tool Set Only - Packed in Keep Safe Foam System

Contents Include:

Drive Tools:		Drive Tools:	
Product Code	Description	Product Code	Description
JHWB-52EHA	8" Enclosed Head Ratchet	JHWB-110	6" Extension
JHWB-108	3" Extension	JHWB-140A	Universal Joint

Shallow 6-Point Sockets, SAE		Shallow 6-Point Sockets, mm	
Product Code	Size (Inches)	Product Code	Metric Size (mm)
JHWB-608	1/4	JHWBM-606	6
JHWB-610	5/16	JHWBM-607	7
JHWB-612	3/8	JHWBM-608	8
JHWB-614	7/16	JHWBM-609	9
JHWB-616	1/2	JHWBM-610	10
JHWB-618	9/16	JHWBM-611	11
		JHWBM-612	12
		JHWBM-613	13
		JHWBM-614	14
		JHWBM-615	15
		JHWBM-616	16
		JHWBM-617	17
		JHWBM-618	18
		JHWBM-619	19

Shallow 12-point Sockets, SAE	
Product Code	Size (Inches)
JHWB-1220	5/8
JHWB-1222	11/16
JHWB-1224	3/4
JHWB-1226	13/16
JHWB-1228	7/8

Features

- Keep-Safe-Foam system keeps tools organized and helps prevent loss
- All tools are professional quality, made of high-grade chrome vanadium steel
- Sockets feature SUPERTORQUE™ lobular openings for greater turning power without deforming the fastener
- Metal tool box made for years of rugged use



JHWW SMB29FTB

3/8" DRIVE

SOCKETS AND
DRIVE TOOLS

39 PIECE 3/8" DRIVE SOCKET AND DRIVE TOOL SET



6 & 12 Point Metric, Packed in Exclusive Keep-Safe-Foam System with Metal Box

Product Code	Description
JHWMSB-39FTB	39 Piece Tool Set with TB-104 Metal Tool Box
JHWMSB-39F	39 Piece Tool Set Only - Packed in Keep Safe Foam System

Contents Include:

Drive Tools:		Drive Tools:	
Product Code	Description	Product Code	Description
JHWB-52EHA	8" Enclosed Head Ratchet	JHWB-20A	Sliding T-Handle
JHWB-108	3" Extension	JHWB-70	Ratchet Spinner
JHWB-110	6" Extension		
JHWB-115	11" Extension		
JHWBF-8	8" Flexible Extension	Shallow 12-Point Sockets	
JHWB-40B	8 9/16" Flex Handle	Product Code	Size (MM)
JHWB-140A	Universal Joint	JHWBM-1206	6
		JHWBM-1207	7
		JHWBM-1208	8
		JHWBM-1209	9
		JHWBM-1210	10
		JHWBM-1211	11
		JHWBM-1212	12
		JHWBM-1213	13
		JHWBM-1214	14
		JHWBM-1215	15
		JHWBM-1216	16
		JHWBM-1217	17
		JHWBM-1218	18
		JHWBM-1219	19
		JHWBM-1220	20
		JHWBM-1221	21
		JHWBM-1222	22
		JHWBM-1224	24

Deep 6-Point Sockets	
Product Code	Size (MM)
JHWBMD-608	8
JHWBMD-609	9
JHWBMD-610	10
JHWBMD-611	11
JHWBMD-612	12
JHWBMD-613	13
JHWBMD-614	14
JHWBMD-615	15
JHWBMD-616	16
JHWBMD-617	17
JHWBMD-618	18
JHWBMD-619	19

Features

- Keep-Safe-Foam system keeps tools organized and helps prevent loss
- All tools are professional quality, made of high-grade chrome vanadium steel
- Sockets feature SUPERTORQUE™ lobular openings for greater turning power without deforming the fastener
- Metal tool box made for years of rugged use

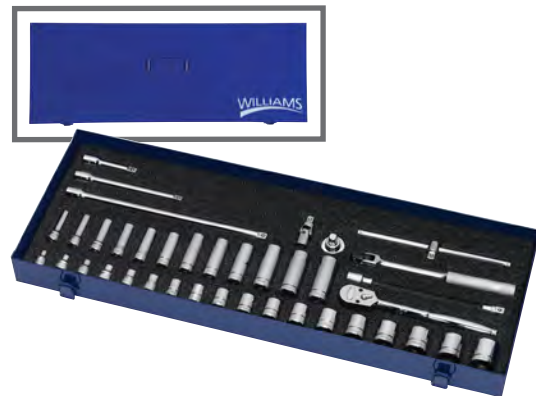

JHWMSB-39FTB

3/8" DRIVE

SOCKETS AND
DRIVE TOOLS





JHWMSB29HFTB

29 PIECE 3/8" DRIVE SOCKET AND DRIVE TOOL SET



6 Point Metric, Packed in Exclusive Keep-Safe-Foam System with Metal Box

Product Code	Description
JHWMSB29HFTB	29 Piece Tool Set with TB-103 Metal Tool Box
JHWMSB-29HF	29 Piece Tool Set Only - Packed in Keep Safe Foam System

Contents Include:

Drive Tools:		Drive Tools:	
Product Code	Description	Product Code	Description
JHWB-52EHA	8" Enclosed Head Ratchet	JHWB-40B	8 9/16" Flex Handle
JHWB-108	3" Extension	JHWB-140A	Universal Joint
JHWB-110	6" Extension		

Shallow 6-Point Sockets		Deep 6-Point Sockets	
Product Code	Size (MM)	Product Code	Size (MM)
JHWBM-608	8	JHWBMD-608	8
JHWBM-609	9	JHWBMD-609	9
JHWBM-610	10	JHWBMD-610	10
JHWBM-611	11	JHWBMD-611	11
JHWBM-612	12	JHWBMD-612	12
JHWBM-613	13	JHWBMD-613	13
JHWBM-614	14	JHWBMD-614	14
JHWBM-615	15	JHWBMD-615	15
JHWBM-616	16	JHWBMD-616	16
JHWBM-617	17	JHWBMD-617	17
JHWBM-618	18	JHWBMD-618	18
JHWBM-619	19	JHWBMD-619	19

Features

- Keep-Safe-Foam system keeps tools organized and helps prevent loss
- All tools are professional quality, made of high-grade chrome vanadium steel
- Sockets feature SUPERTORQUE™ lobular openings for greater turning power without deforming the fastener
- Metal tool box made for years of rugged use



JHWMSB-29FTB

29 PIECE 3/8" DRIVE SOCKET AND DRIVE TOOL SET



6 & 12 Point Metric, Packed in Exclusive Keep-Safe-Foam System with Metal Box

Product Code	Description
JHWMSB-29FTB	29 Piece Tool Set with TB-103 Metal Tool Box
JHWMSB-29F	29 Piece Tool Set Only - Packed in Keep Safe Foam System

Contents Include:

Drive Tools:		Drive Tools:	
Product Code	Description	Product Code	Description
JHWB-52EHA	8" Enclosed Head Ratchet	JHWB-40B	8 9/16" Flex Handle
JHWB-108	3" Extension	JHWB-140A	Universal Joint
JHWB-110	6" Extension		

Shallow 12-Point Sockets		Deep 6-Point Sockets	
Product Code	Size (MM)	Product Code	Size (MM)
JHWBM-1208	8	JHWBMD-608	8
JHWBM-1209	9	JHWBMD-609	9
JHWBM-1210	10	JHWBMD-610	10
JHWBM-1211	11	JHWBMD-611	11
JHWBM-1212	12	JHWBMD-612	12
JHWBM-1213	13	JHWBMD-613	13
JHWBM-1214	14	JHWBMD-614	14
JHWBM-1215	15	JHWBMD-615	15
JHWBM-1216	16	JHWBMD-616	16
JHWBM-1217	17	JHWBMD-617	17
JHWBM-1218	18	JHWBMD-618	18
JHWBM-1219	19	JHWBMD-619	19

Features

- Keep-Safe-Foam system keeps tools organized and helps prevent loss
- All tools are professional quality, made of high-grade chrome vanadium steel
- Sockets feature SUPERTORQUE™ lobular openings for greater turning power without deforming the fastener
- Metal tool box made for years of rugged use



3/8" DRIVE

SOCKETS AND DRIVE TOOLS

18 PIECE 3/8" DRIVE SOCKET AND DRIVE TOOL SET



6 Point Metric, Packed in Exclusive Keep-Safe-Foam System with Metal Box

Product Code	Description
JHWMSB18HFTB	18 Piece Tool Set with TB-102 Metal Tool Box
JHWMSB-18HF	18 Piece Tool Set Only - Packed in Keep Safe Foam System

Contents Include:

Drive Tools:		Drive Tools:	
Product Code	Description	Product Code	Description
JHWB-52EHA	8" Enclosed Head Ratchet	JHWB-110	6" Extension
JHWB-108	3" Extension	JHWB-140A	Universal Joint

Shallow 6-Point Sockets		Shallow 6-Point Sockets	
Product Code	Size (MM)	Product Code	Size (MM)
JHWBM-606	6	JHWBM-613	13
JHWBM-607	7	JHWBM-614	14
JHWBM-608	8	JHWBM-615	15
JHWBM-609	9	JHWBM-616	16
JHWBM-610	10	JHWBM-617	17
JHWBM-611	11	JHWBM-618	18
JHWBM-612	12	JHWBM-619	19

Features

- Keep-Safe-Foam system keeps tools organized and helps prevent loss
- All tools are professional quality, made of high-grade chrome vanadium steel
- Sockets feature SUPERTORQUE™ lobular openings for greater turning power without deforming the fastener
- Metal tool box made for years of rugged use



Made in U.S.A.



JHWMSB18HFTB

17 PIECE 3/8" DRIVE SOCKET AND DRIVE TOOL SET



12 Point Metric, Packed in Exclusive Keep-Safe-Foam System with Metal Box

Product Code	Description
JHWMSB-17FTB	17 Piece Tool Set with TB-102 Metal Tool Box
JHWMSB-17F	17 Piece Tool Set Only - Packed in Keep Safe Foam System

Contents Include:

Drive Tools:		Drive Tools:	
Product Code	Description	Product Code	Description
JHWB-52EHA	8" Enclosed Head Ratchet	JHWB-40B	8 9/16" Flex Handle
JHWB-108	3" Extension	JHWB-140A	Universal Joint
JHWB-110	6" Extension		

Shallow 12-Point Sockets		Shallow 12-Point Sockets	
Product Code	Size (MM)	Product Code	Size (MM)
JHWBM-1208	8	JHWBM-1214	14
JHWBM-1209	9	JHWBM-1215	15
JHWBM-1210	10	JHWBM-1216	16
JHWBM-1211	11	JHWBM-1217	17
JHWBM-1212	12	JHWBM-1218	18
JHWBM-1213	13	JHWBM-1219	19

Features

- Keep-Safe-Foam system keeps tools organized and helps prevent loss
- All tools are professional quality, made of high-grade chrome vanadium steel
- Sockets feature SUPERTORQUE™ lobular openings for greater turning power without deforming the fastener
- Metal tool box made for years of rugged use



Made in U.S.A.



JHWMSB-17FTB

3/8" DRIVE

SOCKETS AND DRIVE TOOLS





JHWMSB-16FTB

16 PIECE 3/8" DRIVE SOCKET AND DRIVE TOOL SET



12 Point Metric, Packed in Exclusive Keep-Safe-Foam System with Metal Box

Product Code	Description
JHWMSB-16FTB	16 Piece Tool Set with TB-102 Metal Tool Box
JHWMSB-16F	16 Piece Tool Set Only - Packed in Keep Safe Foam System

Contents Include:

Drive Tools:		Shallow 12-Point Sockets	
Product Code	Description	Product Code	Size (MM)
JHWB-52EHA	8" Enclosed Head Ratchet	JHWBM-1213	13
JHWB-108	3" Extension	JHWBM-1214	14
		JHWBM-1216	16
		JHWBM-1217	17
		JHWBM-1218	18
Shallow 12-Point Sockets		JHWBM-1220	20
Product Code	Size (MM)	JHWBM-1221	21
JHWBM-1208	8	JHWBM-1222	22
JHWBM-1209	9	JHWBM-1224	24
JHWBM-1210	10		
JHWBM-1211	11		
JHWBM-1212	12		

Features

- Keep-Safe-Foam system keeps tools organized and helps prevent loss
- All tools are professional quality, made of high-grade chrome vanadium steel
- Sockets feature SUPERTORQUE™ lobular openings for greater turning power without deforming the fastener
- Metal tool box made for years of rugged use



146 PIECE 1/4", 3/8", 1/2" DRIVE SOCKET AND DRIVE TOOL SET



6 & 12 Point Rugged-Case-System Tool Set, SAE and Metric

Product Code	Description
JHW50614B	146 Piece 1/4", 3/8", 1/2" Drive Socket Set

1/4" Drive Contents Include:

1/4" Drive Tools	
Ratchet	
3" Extension Handle	
Universal Joint	
1/4" Drive Deep 6 Point Sockets	
Metric Size (MM)	SAE Size (Inches)
4	3/16
5	7/32
6	1/4
7	9/32
8	5/16
9	11/32
10	3/8
11	7/16
12	1/2
13	

1/4" Drive Shallow 6 Point Sockets	
Metric Size (MM)	SAE Size (Inches)
4	5/32
5	3/16
5.5	7/32
6	1/4
7	9/32
8	5/16
9	11/32
10	3/8
11	7/16
12	1/2
13	9/16
14	

1/4" Drive Hex Bit Sockets	
Metric Size (MM)	SAE Size (Inches)
3	1/8
4	5/32
5	3/16
6	7/32
7	1/4
8	5/16

1/4" Drive Screw-driver Bit Sockets	
Size	Size
5/32" Slotted Tip	#0 Phillips Tip
7/32" Slotted Tip	#1 Phillips Tip
9/32" Slotted Tip	#2 Phillips Tip

1/4" Drive Torx Bit Sockets	
Size	Size
T10	T25
T15	T27
T20	T30

3/8" Drive Contents Include:

3/8" Drive Tools	
Ratchet	
3" Extension	
6" Extension	
Adaptor - 3/8" F x 1/4" M	
3/8" Drive Deep 12 Point Sockets	
Metric Size (MM)	SAE Size (Inches)
6	1/4
7	5/16
8	3/8
9	7/16
10	1/2
11	9/16
12	5/8
13	11/16
14	3/4
15	13/16
16	7/8
17	15/16
18	1
19	

3/8" Drive Shallow 6 Point Sockets	
Metric Size (MM)	SAE Size (Inches)
6	1/4
7	5/16
8	3/8
9	7/16
10	1/2
11	9/16
12	5/8
13	11/16
14	3/4
15	13/16
16	7/8
17	15/16
18	1
19	

3/8" Drive Spark Plug Socket	
SAE Size (Inches)	
5/8	
19/16	

1/2" Drive Contents Include:

1/2" Drive Tools	
Ratchet	
6" Extension	
10" Extension	
Universal Joint	
Adaptor - 1/2" F x 3/8" M	
1/2" Drive Shallow 12 Point Sockets	
SAE Size (Inches)	
3/8	
7/16	
1/2	
9/16	
5/8	
11/16	
3/4	
13/16	
7/8	
15/16	
1	



JHW50614B

Features

- All tools are professional quality, made of high-grade chrome vanadium steel
- Sockets feature SUPERTORQUE™ lobular openings for greater turning power without deforming the fastener
- Packed in rugged high-density polyethylene (HDPE) cases that are strong and durable yet light in weight
- Case is shock proof at both high and low temperatures, equipped with heavy-duty metal latches and hinges
- Two-component handles are easy to grip and comfortable to carry

3/8" DRIVE

SOCKETS AND DRIVE TOOLS





JHW50612B

**138 PIECE
1/4", 3/8", 1/2" DRIVE
SOCKET AND DRIVE
TOOL SET**



6 Point Rugged-Case-System Tool Set, SAE and Metric

Product Code	Description
JHW50612B	138 Piece 1/4", 3/8", 1/2" Drive Socket Set

**1/4" Drive
Contents Include:**

1/4" Drive Tools

- Ratchet
- 1 1/2" Extension
- 3" Extension
- Spinner Handle
- Universal Joint
- Hex Bit Holder

13 Piece Insert Bit Set

**1/4" Drive Deep
6 Point Sockets**

Metric Size (MM)	SAE Size (Inches)
4	5/32
5	3/16
6	7/32
7	1/4
8	9/32
9	5/16
10	11/32
11	3/8
12	7/16
13	1/2

**1/4" Drive Shallow
6 Point Sockets**

Metric Size (MM)	SAE Size (Inches)
4	5/32
5	3/16
5.5	7/32
6	1/4
7	9/32
8	5/16
9	11/32
10	3/8
11	7/16
12	1/2
13	

**3/8" Drive
Contents Include:**

3/8" Drive Tools

- Ratchet
- 3" Extension
- 6" Extension
- Universal Joint
- Adaptor
- Hex Bit Holder

**3/8" Drive Deep
12 Point Sockets**

Metric Size (MM)	SAE Size (Inches)
10	3/8
11	7/16
12	1/2
13	9/16
14	5/8
15	11/16
16	3/4
17	13/16
18	7/8
19	

**3/8" Drive Shallow
6 Point Sockets**

Metric Size (MM)	SAE Size (Inches)
10	3/8
11	7/16
12	1/2
13	9/16
14	5/8
15	11/16
16	3/4
17	
18	
19	

**1/2" Drive
Contents Include:**

1/2" Drive Tools

- Ratchet
- 6" Extension
- 10" Extension
- Universal Joint
- Adaptor

1/2" Drive 12 Point Sockets

Metric Size (MM)	SAE Size (Inches)
10	3/8
11	7/16
12	1/2
13	9/16
14	5/8
15	11/16
16	3/4
17	13/16
18	7/8
19	15/16
21	1
22	1 1/16
24	1 1/8
27	1 3/16
30	1 1/4
32	

Features

- All tools are professional quality, made of high-grade chrome vanadium steel
- Sockets feature SUPERTORQUE™ lobular openings for greater turning power without deforming the fastener
- Packed in rugged high-density polyethylene (HDPE) cases that are strong and durable yet light in weight
- Case is shock proof at both high and low temperatures, equipped with heavy-duty metal latches and hinges
- Two-component handles are easy to grip and comfortable to carry

3/8" DRIVE

SOCKETS AND
DRIVE TOOLS

95 PIECE 1/4" & 3/8" DRIVE MASTER SOCKET AND TOOL SET



6 & 12 Point Rugged-Case-System Tool Set, SAE

Product Code	Description
JHW50611B	95 Piece Master Socket, Wrench, and Screwdriver Set

1/4" Drive Contents Include:

1/4" Drive Tools

- 36 Tooth Quick-Release Ratchet
- 1 1/2" Extension
- 3" Extension
- Flex Handle
- Spinner Handle
- Universal Joint
- 1/4" F x 3/8" M Adapter

1/4" Drive Shallow 6-Point Sockets

- | SAE Size (Inches) |
|-------------------|
| 3/16 |
| 7/32 |
| 1/4 |
| 9/32 |
| 5/16 |
| 11/32 |
| 3/8 |
| 7/16 |
| 1/2 |
| 9/16 |

1/4" Drive Deep 6-Point Sockets

- | SAE Size (Inches) |
|-------------------|
| 3/16 |
| 7/32 |
| 1/4 |
| 9/32 |
| 5/16 |
| 11/32 |
| 3/8 |
| 7/16 |
| 1/2 |
| 9/16 |

1/4" Drive Hex Bit Sockets

Metric Size (MM)	SAE Size (Inches)
3	1/8
4	5/32
5	3/16
6	7/32
7	1/4
8	5/16

1/4" Drive Screwdriver Bit Sockets

Size	Size
5/32" Slotted Tip	#0 Phillips Tip
7/32" Slotted Tip	#1 Phillips Tip
9/32" Slotted Tip	#2 Phillips Tip

1/4" Drive Torx Bit Sockets

Size	Size
T10	T25
T15	T27
T20	T30

3/8" Drive Contents Include:

3/8" Drive Tools

- 38 Tooth Quick-Release Ratchet
- 3" Extension
- 6" Extension
- 10" Extension
- 10" Flex Handle
- Universal Joint
- Sliding T-Handle
- 3/8" F x 1/4" M Adapter
- 3/8" F x 1/2" M Adapter

3/8" Drive Shallow 6-Point Sockets

- | SAE Size (Inches) |
|-------------------|
| 3/16 |
| 7/16 |
| 1/2 |
| 9/16 |
| 5/8 |
| 11/16 |
| 3/4 |
| 13/16 |
| 7/8 |
| 15/16 |
| 1 |

3/8" Drive Deep 12-Point Sockets

- | SAE Size (Inches) |
|-------------------|
| 3/16 |
| 7/16 |
| 1/2 |
| 9/16 |
| 5/8 |
| 11/16 |
| 3/4 |
| 13/16 |
| 7/8 |
| 15/16 |
| 1 |

Other Contents Include:

Comfort Grip Screwdrivers

- 3/16" x 4" Slotted
- 1/4" x 4" Slotted
- #1 x 3" Phillips®
- #2 x 4" Phillips®

12 Point Combination Wrenches

- | SAE Size (Inches) |
|-------------------|
| 1/4 |
| 5/16 |
| 3/8 |
| 7/16 |
| 1/2 |
| 9/16 |
| 5/8 |
| 11/16 |
| 3/4 |



JHW50611B

Features

- All tools are professional quality, made of high-grade chrome vanadium steel
- Sockets feature SUPERTORQUE™ lobular openings for greater turning power without deforming the fastener
- Packed in rugged high-density polyethylene (HDPE) cases that are strong and durable yet light in weight
- Case is shock proof at both high and low temperatures, equipped with heavy-duty metal latches and hinges
- Two-component handles are easy to grip and comfortable to carry

3/8" DRIVE

SOCKETS AND DRIVE TOOLS



JHW50622B

**89 PIECE
1/4" & 3/8" DRIVE
MASTER SOCKET
AND TOOL SET**



6 & 12 Point Rugged-Case-System Tool Set, Metric

Product Code	Description
JHW50622B	89 Piece Master Socket, Wrench and Screwdriver Set

**1/4" Drive
Contents Include:**

- 1/4" Drive Tools**
 36 Tooth Quick-Release Ratchet
 1 1/2" Extension
 3" Extension
 Flex Handle
 Spinner Handle
 Universal Joint
 1/4" F x 3/8" M Adapter

1/4" Drive Hex Bit Sockets	
Metric Size (MM)	SAE Size (Inches)
3	1/8
4	5/32
5	3/16
6	7/32
7	1/4
8	5/16

1/4" Drive Screwdriver Bit Sockets	
Size	Size
5/32" Slotted Tip	#0 Phillips Tip
7/32" Slotted Tip	#1 Phillips Tip
9/32" Slotted Tip	#2 Phillips Tip

1/4" Drive Torx Bit Sockets	
Size	Size
T10	T25
T15	T27
T20	T30

**3/8" Drive
Contents Include:**

- 3/8" Drive Tools**
 38 Tooth Quick-Release Ratchet
 3" Extension
 6" Extension
 10" Extension
 10" Flex Handle
 Universal Joint
 Sliding T-Handle
 3/8" F x 1/4" M Adapter
 3/8" F x 1/2" M Adapter

3/8" Drive Shallow 6-Point Sockets	
Metric Size (MM)	
8	
9	
10	
11	
12	
13	
14	
15	
16	
17	
18	
19	

3/8" Drive Deep 12-Point Sockets	
Metric Size (MM)	
8	
9	
10	
11	
12	
13	
14	
15	
16	
17	
18	
19	

**Other Contents
Include:**

- Comfort Grip
Screwdrivers**
 3/16" x 4" Slotted
 1/4" x 4" Slotted
 #1 x 3" Phillips®
 #2 x 4" Phillips®
- 12 Point Combination
Wrenches**
 Metric Size (MM)
 6
 8
 10
 12
 13
 14
 15
 17
 19

Features

- All tools are professional quality, made of high-grade chrome vanadium steel
- Sockets feature SUPERTORQUE™ lobular openings for greater turning power without deforming the fastener
- Packed in rugged high-density polyethylene (HDPE) cases that are strong and durable yet light in weight
- Case is shock proof at both high and low temperatures, equipped with heavy-duty metal latches and hinges
- Two-component handles are easy to grip and comfortable to carry

3/8" DRIVE

SOCKETS AND
DRIVE TOOLS

79 PIECE 3/8" DRIVE DELUXE SOCKET AND DRIVE TOOL SET



6 & 12 Point Rugged-Case-System Tool Set, SAE and Metric, with 1/4" Hex Screwdriver Bits

Product Code	Description
JHW50607B	79 Piece 3/8" Drive Deluxe Tool Set

1/4" Drive Contents Include:

1/4" Drive Tools

Spinner Handle
Universal Joint
1/4" Hex Bit Holder
Universal Joint

1/4" Hex Screwdriver Bits

5/32" Slotted Tip
3/16" Slotted Tip
1/4" Slotted Tip
#0 Phillips® Tip
#1 Phillips® Tip
#2 Phillips® Tip
#3 Phillips® Tip
#1 Square Tip
#2 Square Tip
1/8" Hex Tip
5/32" Hex Tip
7/32" Hex Tip
1/4" Hex Tip

3/8" Drive Contents Include:

3/8" Drive Tools

38 Tooth Quick-Release Ratchet
3" Extension
6" Extension
10" Extension
10" Flex Handle
Universal Joint
Sliding T-Handle
3/8" F x 1/4" M Adapter
3/8" F x 1/2" M Adapter

3/8" Drive Deep 12 Point Sockets

Metric Size (MM)	SAE Size (Inches)
6	1/4
7	5/16
8	3/8
9	7/16
10	1/2
11	9/16
12	5/8
13	11/16
14	3/4
15	13/16
16	7/8
17	15/16
18	1
19	

3/8" Drive Shallow 6 Point Sockets

Metric Size (MM)	SAE Size (Inches)
6	1/4
7	5/16
8	3/8
9	7/16
10	1/2
11	9/16
12	5/8
13	11/16
14	3/4
15	13/16
16	7/8
17	15/16
18	1
19	



JHW50607B

Features

- All tools are professional quality, made of high-grade chrome vanadium steel
- Sockets feature SUPERTORQUE™ lobular openings for greater turning power without deforming the fastener
- Packed in rugged high-density polyethylene (HDPE) cases that are strong and durable yet light in weight
- Case is shock proof at both high and low temperatures, equipped with heavy-duty metal latches and hinges
- Two-component handles are easy to grip and comfortable to carry

3/8" DRIVE

SOCKETS AND DRIVE TOOLS



JHW50605B

63 PIECE 3/8" DRIVE SOCKET, SCREWDRIVER, AND WRENCH SET



6 & 12 Point Rugged-Case-System Tool Set, SAE and Metric

Product Code	Description
JHW50605B	63 Piece 3/8" Drive Socket, Screwdriver, and Wrench Set

1/4" Drive Contents Include:

- 1/4" Drive Tools
- Spinner Handle
- Universal Joint
- 1/4" Hex Bit Holder

1/4" Hex Screwdriver Bits

- 5/32" Slotted Tip
- 3/16" Slotted Tip
- 1/4" Slotted Tip
- #0 Phillips® Tip
- #1 Phillips® Tip
- #2 Phillips® Tip
- #3 Phillips® Tip
- #1 Square Tip
- #2 Square Tip
- 1/8" Hex Tip
- 5/32" Hex Tip
- 7/32" Hex Tip
- 1/4" Hex Tip

3/8" Drive Contents Include:

- 3/8" Drive Tools
- 38 Tooth Quick-Release Ratchet
- 3" Extension
- 6" Extension
- 10" Extension
- 10" Flex Handle
- Universal Joint
- Sliding T-Handle
- 3/8" F x 1/4" M Adapter
- 3/8" F x 1/2" M Adapter

3/8" Drive Shallow 6 Point Sockets

Metric Size (MM)	SAE Size (Inches)
6	1/4
7	5/16
8	3/8
9	7/16
10	1/2
11	9/16
12	5/8
13	11/16
14	3/4
15	13/16
16	7/8
17	15/16
18	1
19	

Additional Contents Include:

- Comfort Grip Screwdrivers
- 3/16" x 4" Slotted
- 1/4" x 4" Slotted
- #1 x 3" Phillips®
- #2 x 4" Phillips®

12 Point Combination Wrenches

SAE Size (Inches)
1/4
5/16
3/8
7/16
1/2
9/16
5/8

Features

- All tools are professional quality, made of high-grade chrome vanadium steel
- Sockets feature SUPERTORQUE™ lobular openings for greater turning power without deforming the fastener
- Packed in rugged high-density polyethylene (HDPE) cases that are strong and durable yet light in weight
- Case is shock proof at both high and low temperatures, equipped with heavy-duty metal latches and hinges
- Two-component handles are easy to grip and comfortable to carry

58 PIECE 3/8" DRIVE SOCKET, SCREWDRIVER, AND PLIERS SET



6 Point Rugged-Case-System Tool Set, SAE and Metric

Product Code	Description
JHW50615B	58 Piece 3/8" Drive Socket, Screwdriver and Pliers Set

1/4" Drive Contents Include:

1/4" Drive Tools

- Spinner Handle
- Universal Joint
- 1/4" Hex Bit Holder

1/4" Hex Screwdriver Bits

- 5/32" Slotted Tip
- 3/16" Slotted Tip
- 1/4" Slotted Tip
- #0 Phillips® Tip
- #1 Phillips® Tip
- #2 Phillips® Tip
- #3 Phillips® Tip
- #1 Square Tip
- #2 Square Tip
- 1/8" Hex Tip
- 5/32" Hex Tip
- 7/32" Hex Tip
- 1/4" Hex Tip

3/8" Drive Contents Include:

3/8" Drive Tools

- 38 Tooth Quick-Release Ratchet
- 3" Extension
- 6" Extension
- 10" Extension
- 10" Flex Handle
- Universal Joint
- Sliding T-Handle
- 3/8" F x 1/4" M Adapter
- 3/8" F x 1/2" M Adapter

3/8" Drive Shallow

6 Point Sockets

Metric Size (MM)	SAE Size (Inches)
6	1/4
7	3/16
8	3/8
9	7/16
10	1/2
11	9/16
12	5/8
13	11/16
14	3/4
15	13/16
16	7/8
17	15/16
18	1
19	

Additional Contents Include:

Pliers

- 8" Slip Joint Pliers
- 9 3/4" Groove Joint Pliers
- 7" Diagonal Cutting Pliers
- 6 1/4" Long Nose Pliers W / Cutter

Adjustable Wrench

- 8"



JHW50615B

Features

- All tools are professional quality, made of high-grade chrome vanadium steel
- Sockets feature SUPERTORQUE™ lobular openings for greater turning power without deforming the fastener
- Packed in rugged high-density polyethylene (HDPE) cases that are strong and durable yet light in weight
- Case is shock proof at both high and low temperatures, equipped with heavy-duty metal latches and hinges
- Two-component handles are easy to grip and comfortable to carry

3/8" DRIVE

SOCKETS AND DRIVE TOOLS



JHW50613B

35 PIECE 3/8" DRIVE BASIC TOOL SET



6 Point Rugged-Case-System Tool Set, Metric, with 1/4" Hex Screwdriver Bits

Product Code	Description
JHW50613B	35 Piece Basic Tool Set, Metric

1/4" Drive Contents Include:

1/4" Drive Tools

Spinner Handle
Universal Joint
1/4" Hex Bit Holder

1/4" Hex Screwdriver Bits

5/32" Slotted Tip
3/16" Slotted Tip
1/4" Slotted Tip
#0 Phillips® Tip
#1 Phillips® Tip
#2 Phillips® Tip
#3 Phillips® Tip
#1 Square Tip
#2 Square Tip
1/8" Hex Tip
5/32" Hex Tip
7/32" Hex Tip
1/4" Hex Tip

3/8" Drive Contents Include:

3/8" Drive Tools

7 3/4" Ratchet
3" Extension
6" Extension
Universal Joint
1/4" Hex Bit Holder

3/8" Drive Shallow 6-Point Sockets

Metric Size (MM)

6
7
8
9
10
11
12
13
14
15
16
17
18
19

Features

- All tools are professional quality, made of high-grade chrome vanadium steel
- Sockets feature SUPERTORQUE™ lobular openings for greater turning power without deforming the fastener
- Packed in rugged high-density polyethylene (HDPE) cases that are strong and durable yet light in weight
- Case is shock proof at both high and low temperatures, equipped with heavy-duty metal latches and hinges
- Two-component handles are easy to grip and comfortable to carry

34 PIECE 3/8" DRIVE BASIC TOOL SET



6 Point Rugged-Case-System Tool Set, SAE, with 1/4" Hex Screwdriver Bits

Product Code	Description
JHW50603B	34 Piece Basic Tool Set, SAE

1/4" Drive Contents Include:

1/4" Drive Tools

Spinner Handle
Universal Joint
1/4" Hex Bit Holder

1/4" Hex Screwdriver Bits

5/32" Slotted Tip
3/16" Slotted Tip
1/4" Slotted Tip
#0 Phillips® Tip
#1 Phillips® Tip
#2 Phillips® Tip
#3 Phillips® Tip
#1 Square Tip
#2 Square Tip
1/8" Hex Tip
5/32" Hex Tip
7/32" Hex Tip
1/4" Hex Tip

3/8" Drive Contents Include:

3/8" Drive Tools

7/8" Ratchet
3" Extension
6" Extension
Universal Joint
1/4" Hex Bit Holder

3/8" Drive Shallow 6 Point Sockets

SAE Size (Inches)

1/4
5/16
3/8
7/16
1/2
9/16
5/8
11/16
3/4
13/16
7/8
15/16
1



JHW50603B

Features

- All tools are professional quality, made of high-grade chrome vanadium steel
- Sockets feature SUPERTORQUE™ lobular openings for greater turning power without deforming the fastener
- Packed in rugged high-density polyethylene (HDPE) cases that are strong and durable yet light in weight
- Case is shock proof at both high and low temperatures, equipped with heavy-duty metal latches and hinges
- Two-component handles are easy to grip and comfortable to carry

22 PIECE 3/8" DRIVE BOLT THRU SOCKET SET



6 Point Compact Case Tool Set, SAE & Metric

Product Code	Description
JHW50671	22 Piece 3/8" Drive Bolt Thru Socket Set

3/8" Drive Contents Include:

3/8" Drive Tools

Locking Flexible Ratchet
3" Extension
Adaptor

3/8" Drive Shallow

6 Point Sockets

Metric Size (MM)	SAE Size (Inches)
8	3/8
9	7/16
10	1/2
11	9/16
12	5/8
13	11/16
14	3/4
15	
16	
17	
18	
19	



JHW50671

Features

- All tools are professional quality, made of high-grade chrome vanadium steel
- Sockets feature SUPERTORQUE™ lobular openings for greater turning power without deforming the fastener
- Packed in rugged high-density polyethylene (HDPE) cases that are strong and durable yet light in weight
- Ratchet with 7 locking positions and flex head design



JHW50664

18 PIECE 3/8" DRIVE SOCKET AND DRIVE TOOL SET



6 & 12 Point Compact Case Tool Set, SAE

Product Code	Description
JHW50664	18 Piece 3/8" Drive Socket and Drive Tool Set

3/8" Drive Contents Include:

3/8" Drive Tools	3/8" Drive Shallow 6 Point Sockets	3/8" Drive Deep 12 Point Sockets
7 3/4" Pear Head Ratchet	SAE Size (Inches)	SAE Size (Inches)
3" Extension	3/8	3/8
6" Extension	7/16	7/16
	1/2	1/2
	9/16	9/16
3/8" Drive Spark Plug Socket	5/8	5/8
	11/16	11/16
	3/4	3/4

Features

- All tools are professional quality, made of high-grade chrome vanadium steel
- Sockets feature SUPERTORQUE™ lobular openings for greater turning power without deforming the fastener
- Packed in rugged compact high-density polyethylene (HDPE) cases that are strong and durable yet light in weight



JHW50666

47 PIECE 3/8" DRIVE SOCKET AND DRIVE TOOL SET



6 & 12 Point Compact Case Tool Set, SAE & Metric

Product Code	Description
JHW50666	47 Piece 3/8" Drive Socket and Drive Tool Set

3/8" Drive Contents Include:

3/8" Drive Tools	3/8" Drive Shallow 6 Point Sockets		3/8" Drive Deep 12 Point Sockets	
	Metric Size (MM)	SAE Size (Inches)	Metric Size (MM)	SAE Size (Inches)
5 1/4" Pear Head Ratchet	6	5/16	7	5/16
3" Extension	7	3/8	8	3/8
1 1/2" Extension	8	7/16	9	7/16
Universal Joint	9	1/2	10	1/2
	10	9/16	11	9/16
	11	5/8	12	5/8
	12	11/16	13	11/16
	13	3/4	14	3/4
	14		15	
	15		16	
	16		17	
	17		18	
	18		19	
	19			

Features

- All tools are professional quality, made of high-grade chrome vanadium steel
- Sockets feature SUPERTORQUE™ lobular openings for greater turning power without deforming the fastener
- Packed in rugged compact high-density polyethylene (HDPE) cases that are strong and durable yet light in weight

3/8" DRIVE

SOCKETS AND
DRIVE TOOLS

15 PIECE 3/8" DRIVE SOCKET AND DRIVE TOOL SET



12 Point Compact Case Tool Set, SAE

Product Code	Description
JHW50673	15 Piece 3/8" Drive Socket and Drive Tool Set

Contents Include:

3/8" Drive Tools:	3/8" Drive Shallow 12 Point Sockets:		
	Description	Size (Inches)	Size (Inches)
7 3/4" Pear Head Ratchet	1/4	1/2	3/4
3" Extension	5/16	9/16	13/16
6" Extension	3/8	5/8	7/8
Universal Joint	7/16	11/16	

Features

- All tools are professional quality, made of high-grade chrome vanadium steel
- Sockets feature SUPERTORQUE™ lobular openings for greater turning power without deforming the fastener
- Packed in rugged compact high-density polyethylene (HDPE) cases that are strong and durable yet light in weight



JHW50673

15 PIECE 3/8" DRIVE SOCKET AND DRIVE TOOL SET



6 Point Compact Case Tool Set, SAE

Product Code	Description
JHW50663	15 Piece 3/8" Drive Socket and Drive Tool Set

Contents Include:

3/8" Drive Tools:	3/8" Drive Shallow 6 Point Sockets:		
	Description	Size (Inches)	Size (Inches)
7 3/4" Pear Head Ratchet	1/4	1/2	3/4
3" Extension	5/16	9/16	13/16
6" Extension	3/8	5/8	7/8
Universal Joint	7/16	11/16	

Features

- All tools are professional quality, made of high-grade chrome vanadium steel
- Sockets feature SUPERTORQUE™ lobular openings for greater turning power without deforming the fastener
- Packed in rugged compact high-density polyethylene (HDPE) cases that are strong and durable yet light in weight



JHW50663

15 PIECE 3/8" DRIVE SOCKET AND DRIVE TOOL SET



6 Point Compact Case Tool Set, Metric

Product Code	Description
JHW50665	16 Piece 3/8" Drive Socket and Drive Tool Set

Contents Include:

3/8" Drive Tools:	3/8" Drive Shallow 6 Point Sockets:		
	Description	Size (mm)	Size (mm)
7 3/4" Pear Head Ratchet	8	12	16
3" Extension	9	13	17
6" Extension	10	14	18
Universal Joint	11	15	19

Features

- All tools are professional quality, made of high-grade chrome vanadium steel
- Sockets feature SUPERTORQUE™ lobular openings for greater turning power without deforming the fastener
- Packed in rugged compact high-density polyethylene (HDPE) cases that are strong and durable yet light in weight



JHW50665

3/8" DRIVE ENCLOSED HEAD RATCHETS

Williams® Sealed Narrow Head Design,
Chrome and Black Industrial Finish

Product Code	Description	Length (Inches)	Number of Teeth
JHWB-52EHA	Chrome Finish Enclosed Head Ratchet	8	36
JHWB-52EHLA	Chrome Finish Enclosed Head Ratchet, Long	10 1/4	36
JHWB-52EHFB	Chrome Finish Flex Head Ratchet	9 11/16	36
JHWBB-52EHA	Black Industrial Finish Enclosed Head Ratchet	8	36
JHWB-52EHRKA	Repair Kit for Enclosed Head Ratchets		

Fed. Spec: ANSI B107.10M

Features

- Enclosed head is sealed to prevent dust, dirt, and liquids from entering head, preserving internal lubrication
- Forged one-piece ratchet provide strength and safety for industrial applications
- Smooth comfort-grip handle permits all-day use without gloves
- 36 tooth gear with 10 degree of engagement allows engagement in tight working areas
- Nickel/Chrome plating provides increase protection from rust and corrosion
- Chrome finish models feature mirror-like exterior that can be easily cleaned after each use
- Single Pawl ratchet design:
 - 1) Designed for tighter tolerances between pawl and gear which reduces metal fatigue and slippage under load
 - 2) Does not require as many working parts, reducing possible breakage and parts to repair
- Easy access reverse lever allows user to change working direction quickly and easily with only one hand



Made in U.S.A.

3/8" DRIVE ROUND HEAD RATCHETS

Knurled Handle, Chrome and Black Industrial Finish

Product Code	Description	Length (Inches)	Number of Teeth
JHWB-52A	Chrome Finish Round Head Ratchet	7 5/8	72
JHWB-53A	Chrome Finish Round Head Ratchet, Long	10 1/2	72
JHWBB-52A	Black Industrial Finish Round Head Ratchet	7 5/8	72
JHWB-52ARK	Repair Kit for Round Head Ratchets		

Fed. Spec: ANSI B107.10M

Features

- Double pawl design with 72 teeth action provides a 5° ratcheting angle
- Shift lever reverses action instantly
- Knurled handle provides a non-slip grip
- Chrome finish models provides increased protection from rust and corrosion



Made in U.S.A.



3/8" DRIVE HANDLES

Knurled Handle, High-Polished Chrome Finish

Product Code	Description	Length (Inches)
JHWB-40B	Flex Handle	8 9/16
JHWB-20A	Sliding T-Handle	7 15/16
JHWB-15	Speeder Handle	18

Fed. Spec: ANSI B107.10M

Features

- Chrome plating provides increased protection from rust and corrosion
- Drive handles provide extra leverage with greater strength than ratchets
- Speeder handle is ideal for fast turn down of fasteners

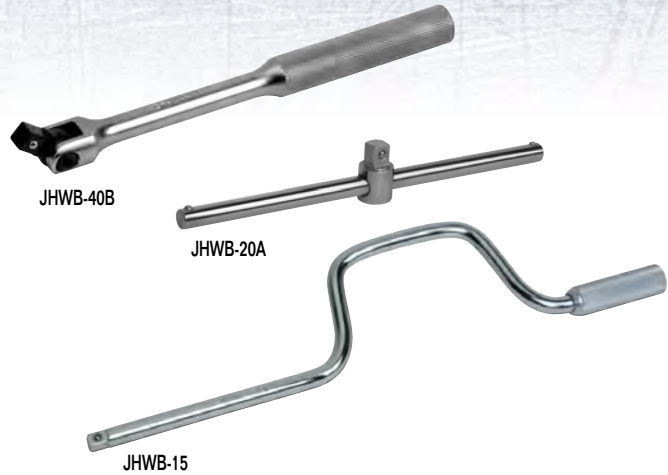

3/8" DRIVE EXTENSIONS AND ACCESSORIES

High-Polished Chrome Finish

Product Code	Description	Length (Inches)
JHWB-101	Extension	1 1/2
JHWB-108	Extension	3
JHWB-110	Extension	6
JHWB-115	Extension	11
JHWB-118	Extension	18
JHWBFE-8	Flexible Extension	8
JHWB-140A	Universal Joint	2
JHWB-70	Ratchet Spinner Disk	1 1/4

Fed. Spec: ANSI B107.10M

JHWWSB-5XT 5 Piece Extension Set in Pouch - 049605

Contents Include:

Product Code	Size (Inches)	Product Code	Size (Inches)
JHWB-101	1 1/2	B-115	11
JHWB-108	3	B-118	18
JHWB-110	6		

Features

- Chrome plating provides increased protection from rust and corrosion
- Flexible extension is designed for low torque applications in limited access areas
- Ball and spring socket retention
- Spinner disk is ideal for fast turn down of fasteners

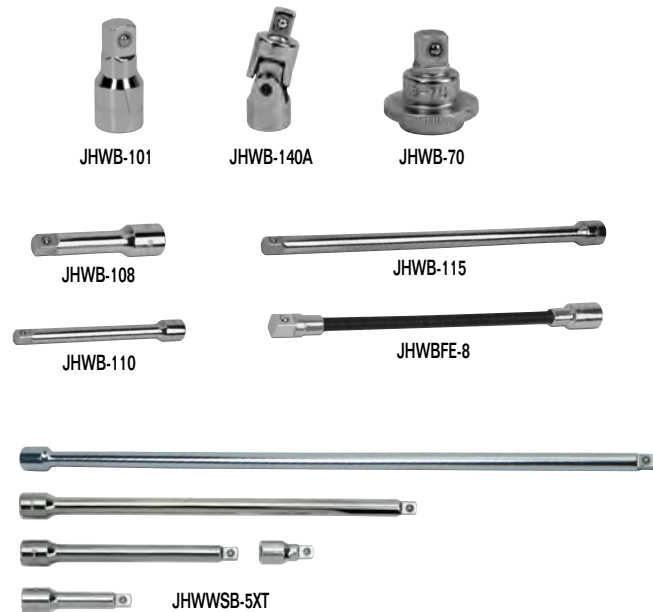

3/8" DRIVE

SOCKETS AND DRIVE TOOLS

3/8" DRIVE ADAPTORS

High-Polished Chrome and Black Industrial Finish

Product Code	Length (Inches)	Male End (Inches)	Female End (Inches)
--------------	-----------------	-------------------	---------------------

Chrome Finish

JHWBS-130	1 5/16	1/2	3/8
-----------	--------	-----	-----

Black Industrial Finish

JHWBS-130B	1 5/16	1/2	3/8
JHWBS-131BF	1 5/16	3/8	1/2

Fed. Spec: ANSI B107.10M

Features

- Ball and spring socket retention



3/8" DRIVE RATCHETS AND HANDLES

High-Polished Chrome Finish

Product Code	Description	Length (Inches)
JHW11920	Flex Handle, Comb. 3/8" x 1/2" Drive	10
JHW31016A	3/8" Drive Spinner Handle	9

Fed. Spec: ANSI B107.10M

Features

- High-polished chrome finish for easy cleaning
- Spinner handles features three component comfort grip handle
- Unique combination 3/8" x 1/2" drive flex handle offers convenience of both drive sizes on one handle



3/8" DRIVE EXTENSIONS AND ACCESSORIES

High-Polished Chrome Finish

Product Code	Description	Length (Inches)
JHW31013	Holder for 1/4" Hex Screwdriver Bits	3/4
JHW31023	Locking Extension	3
JHW31024	Locking Extension	6
JHW31025	Locking Extension	10
JHW31026	Locking Extension	12
JHW31027	Locking Extension	18
JHW31028	Locking Extension	24

Fed. Spec: ANSI B107.10M

Features

- Chrome plating provides increased protection from rust and corrosion
- Ball and spring socket retention

3/8" WOBBLE EXTENSIONS

High-Polished Chrome Finish

Product Code	Length (Inches)
JHWB-201	1
JHWB-203	3
JHWB-206	6
JHWB-208	8
JHWB-211	11
JHWB-218	18

Fed. Spec: ANSI B107.10M

Features

- Chrome plating provides increased protection from rust and corrosion
- Provides 16 degrees of additional accessibility

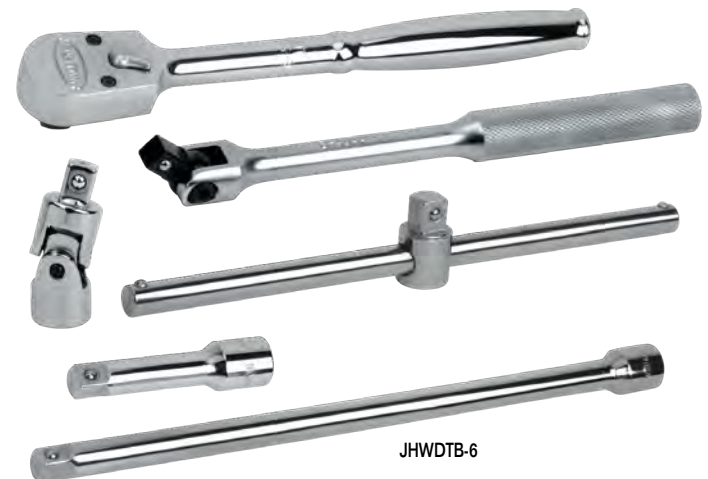

6 PIECE 3/8" DRIVE RATCHET AND DRIVE TOOL SET

Furnished in a Pouch

Product Code	Description
JHWDTB-6	6 Piece 3/8" Drive Ratchet and Accessory Set

Contents Include:

Product Code	Description
JHWB-52EHA	Chrome Finish Enclosed Head Ratchet
JHWB-108	3" Extension
JHWB-115	10" Extension
JHWB-40B	Flex Handle
JHWB-140A	Universal Joint
JHWB-20A	Sliding T-Handle

Features

- All tools are professional quality, made of high-grade chrome vanadium steel



3/8" DRIVE SHALLOW, 12 POINT SOCKETS, SAE

High-Polished Chrome Finish

Product Code	Size (Inches)	A OAL (Inches)	B Drive End Diameter (Inches)	C Working End Diameter (Inches)	D Broach Depth (Inches)	E Bolt Clearance Depth (Inches)	F Bolt Clearance Diameter (Inches)	Nose Length (Inches)
JHWB-1208	1/4	1 1/32	11/16	13/32	7/32	9/16	7/32	17/32
JHWB-1210	5/16	1 1/32	11/16	7/16	1/4	9/16	17/64	17/32
JHWB-1211	11/32	1 1/32	11/16	1/2	9/32	9/16	21/64	17/32
JHWB-1212	3/8	1 1/32	11/16	9/16	9/32	9/16	11/32	17/32
JHWB-1214	7/16	1 1/32	11/16	5/8	5/16	9/16	11/32	17/32
JHWB-1216	1/2	1 1/32	23/32	23/32	11/32	3/8	3/8	-
JHWB-1217	17/32	1 1/32	25/32	25/32	19/32	3/4	1/2	-
JHWB-1218	9/16	1 3/32	25/32	25/32	9/16	19/32	17/32	-
JHWB-1219	19/32	1 3/32	25/32	25/32	9/16	9/16	9/16	-
JHWB-1220	5/8	1 1/8	27/32	27/32	19/32	5/8	19/32	-
JHWB-1222	11/16	1 5/32	15/16	15/16	5/8	5/8	11/16	-
JHWB-1224	3/4	1 3/16	1	1	11/16	11/16	23/32	-
JHWB-1226	13/16	1 1/4	1 1/16	1 1/16	11/16	11/16	25/32	-
JHWB-1228	7/8	1 9/32	1 5/32	1 5/32	25/32	25/32	7/8	-
JHWB-1230	15/16	1 3/8	1 1/4	1 1/4	19/16	27/32	29/32	-
JHWB-1232	1	1 13/32	1 5/16	1 5/16	27/32	7/8	1	-

Fed. Spec: ANSI B107.110



JHWB-1212

JHWB-1208

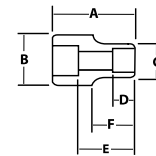

JHWSB-10RC 10 Piece 3/8" Drive Shallow 12-Point Socket Set on Clip Rail

Contents Include:

Product Code	Size (Inches)	Product Code	Size (Inches)	Product Code	Size (Inches)
JHWB-1210	5/16	JHWB-1218	9/16	JHWB-1226	13/16
JHWB-1212	3/8	JHWB-1220	5/8	JHWB-1228	7/8
JHWB-1214	7/16	JHWB-1222	11/16		
JHWB-1216	1/2	JHWB-1224	3/4		

JHWSB-13RC 13 Piece 3/8" Drive Shallow 12-Point Socket Set on Clip Rail

Contents Include:

Product Code	Size (Inches)	Product Code	Size (Inches)	Product Code	Size (Inches)
JHWB-1208	1/4	JHWB-1218	9/16	JHWB-1228	7/8
JHWB-1210	5/16	JHWB-1220	5/8	JHWB-1230	15/16
JHWB-1212	3/8	JHWB-1222	11/16	JHWB-1232	1
JHWB-1214	7/16	JHWB-1224	3/4		
JHWB-1216	1/2	JHWB-1226	13/16		

Features

- SUPERTORQUE™ lobular openings for greater turning power without deforming the fastener
- Designed for quick engagement on both 6 and 12 point fasteners



3/8" DRIVE

SOCKETS AND DRIVE TOOLS



JHWSB-10RC



JHWSB-13RC





3/8" DRIVE SHALLOW SOCKETS, 6 POINT, SAE

High-Polished Chrome Finish



JHWB-616

JHWB-608

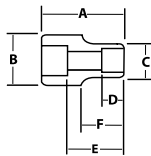

Product Code	Size (Inches)	A OAL (Inches)	B Drive End Diameter (Inches)	C Working End Diameter (Inches)	D Broach Depth (Inches)	E Bolt Clearance Depth (Inches)	F Nose Length (Inches)
JHWB-608	1/4	1 1/32	1 1/16	1 9/32	7/32	9/16	1/2
JHWB-610	5/16	1 1/32	1 1/16	1 7/16	1/4	9/16	1/2
JHWB-611	11/32	1 1/32	1 1/16	1 1/2	9/32	9/16	1/2
JHWB-612	3/8	1 1/32	1 1/16	1 9/16	9/32	9/16	1/2
JHWB-614	7/16	1 1/32	1 1/16	1 5/8	5/16	9/16	1/2
JHWB-616	1/2	1 1/32	23/32	23/32	11/32	9/16	-
JHWB-618	9/16	1 3/32	25/32	25/32	9/16	19/32	-
JHWB-620	5/8	1 1/8	27/32	27/32	19/32	5/8	-
JHWB-622	11/16	1 9/32	15/16	15/16	21/32	5/8	-
JHWB-624	3/4	1 3/16	1	1	21/32	11/16	-
JHWB-626	13/16	1 1/4	1 1/16	1 1/16	11/16	23/32	-
JHWB-628	7/8	1 9/32	1 5/32	1 5/32	3/4	25/32	-
JHWB-630	15/16	1 3/8	1 1/4	1 1/4	13/16	27/32	-
JHWB-632	1	1 19/32	1 5/16	1 5/16	27/32	7/8	-

Fed. Spec: ANSI B107.110

JHWWSS-8HRC 8 Piece 3/8" Drive Shallow 6 Point Socket Set on Clip Rail

Contents Include:

Product Code	Size (Inches)	Product Code	Size (Inches)	Product Code	Size (Inches)
JHWB-608	1/4	JHWB-614	7/16	JHWB-620	5/8
JHWB-610	5/16	JHWB-616	1/2	JHWB-624	3/4
JHWB-612	3/8	JHWB-618	9/16		

JHWWSB-10HRC 10 Piece 3/8" Drive Shallow 6 Point Socket Set on Clip Rail

Contents Include:

Product Code	Size (Inches)	Product Code	Size (Inches)	Product Code	Size (Inches)
JHWB-610	5/16	JHWB-618	9/16	JHWB-626	13/16
JHWB-612	3/8	JHWB-620	5/8	JHWB-628	7/8
JHWB-614	7/16	JHWB-622	11/16		
JHWB-616	1/2	JHWB-624	3/4		

JHWWSB-13HRC 13 Piece 3/8" Drive Shallow 6 Point Socket Set on Clip Rail

Contents Include:

Product Code	Size (Inches)	Product Code	Size (Inches)	Product Code	Size (Inches)
JHWB-608	1/4	JHWB-618	9/16	JHWB-628	7/8
JHWB-610	5/16	JHWB-620	5/8	JHWB-630	15/16
JHWB-612	3/8	JHWB-622	11/16	JHWB-632	1
JHWB-614	7/16	JHWB-624	3/4		
JHWB-616	1/2	JHWB-626	13/16		

Features

- SUPERTORQUE™ lobular openings for greater turning power without deforming the fastener
- Designed for maximum engagement on 6 point fasteners



JHWWSS-8HRC



JHWWSB-10HRC



JHWWSB-13HRC

3/8" DRIVE

SOCKETS AND DRIVE TOOLS

3/8" DRIVE SHALLOW SOCKETS, 4 & 8 POINT, SAE



High-Polished Chrome Finish

Product Code	Size (Inches)	A OAL (Inches)	B Drive End Diameter (Inches)	C Working End Diameter (Inches)	D Broach Depth (Inches)	E Bolt Clearance Depth (Inches)	F Bolt Clearance Diameter (Inches)	Nose Length (Inches)
JHWBD-808	1/4	29/32	21/32	15/32	7/32	13/32	5/32	7/16
JHWB-409 **	9/32	1 1/32	11/16	9/16	9/16	17/32	9/16	1/2
JHWBD-810	5/16	29/32	21/32	9/16	1/4	13/32	1/4	7/16
JHWBD-812	3/8	15/16	11/16	41/64	9/32	7/16	5/16	15/32
JHWBD-814	7/16	1	23/32	23/32	9/32	1/2	5/16	-
JHWBD-816	1/2	1	29/32	29/32	5/16	1/2	13/32	-
JHWBD-818	9/16	1 1/8	1	1	13/32	5/8	17/32	-
JHWBD-820	5/8	1 1/8	1 1/16	1 1/16	7/16	5/8	19/32	-

** 4 Point Socket
Fed. Spec: ANSI B107.110



JHWBD-814



JHWWSD-7RC

JHWWSD-7RC 7 Piece 8 Point Socket Set on Clip Rail

Contents Include:

Product Code	Size (Inches)	Product Code	Size (Inches)	Product Code	Size (Inches)
JHWBD-808	1/4	JHWBD-814	7/16	JHWBD-820	5/8
JHWBD-810	5/16	JHWBD-816	1/2		
JHWBD-812	3/8	JHWBD-818	9/16		

Features

- SUPERTORQUE™ lobular openings for greater turning power without deforming the fastener
- 8 point sockets are designed for quick engagement on 4 point fasteners



Made in U.S.A.

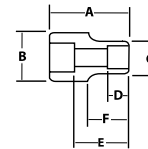

3/8" DRIVE 5 POINT PENTA-SOCKET



Black Industrial Finish

Product Code	Size (Inches)	A OAL (Inches)	B Drive End Diameter (Inches)	C Working End Diameter (Inches)	D Broach Depth (Inches)	E Bolt Clearance Depth (Inches)	F Bolt Clearance Diameter (Inches)	Nose Length (Inches)
JHWBB-526	5/64	1 1/16	1 1/8	1 1/8	7/16	1/2	23/32	-

Features

- 5 point Penta-Socket services 5 point nuts found on tamper-resistant Buffalo covers used by gas, electric, and some water companies to protect shutoff gates



Made in U.S.A.



JHWBB-526

3/8" DRIVE UNIVERSAL SOCKETS, 12 POINT, SAE



High-Polished Chrome Finish

Product Code	Size (Inches)	A OAL (Inches)	B Drive End Diameter (Inches)	C Open End Diameter (Inches)	D Broach Depth (Inches)	E Bolt Clearance Depth (Inches)	F Bolt Clearance Diameter (Inches)	Nose Length (Inches)
JHWBU-1212	3/8	1 25/32	3/4	1/2	1/4	1/2	5/16	15/64
JHWBU-1214	7/16	1 25/32	3/4	5/8	1/4	1/2	11/32	15/64
JHWBU-1216	1/2	1 25/32	3/4	11/16	5/16	9/16	11/32	9/32
JHWBU-1218	9/16	1 25/32	3/4	3/4	11/32	5/8	11/32	17/32
JHWBU-1220	5/8	1 25/32	3/4	7/8	13/32	11/16	11/32	17/32
JHWBU-1222	11/16	2	3/4	15/16	7/16	23/32	11/32	17/32
JHWBU-1224	3/4	2 1/8	3/4	1	17/32	13/16	11/32	5/8

Fed. Spec: ANSI B107.110



JHWBU-1220 JHWBU-1212

JHWWSB-7U 7 Piece 12 Point Universal Socket Set on Clip Rail

Contents Include:

Product Code	Size (Inches)	Product Code	Size (Inches)	Product Code	Size (Inches)
JHWBU-1212	3/8	JHWBU-1218	9/16	JHWBU-1224	3/4
JHWBU-1214	7/16	JHWBU-1220	5/8		
JHWBU-1216	1/2	JHWBU-1222	11/16		

Features

- Ideal for work in confined areas where fastener is inaccessible to standard sockets



Made in U.S.A.



JHWWSB-7U

3/8" DRIVE

SOCKETS AND DRIVE TOOLS





3/8" DRIVE UNIVERSAL SOCKETS, 6 POINT, SAE

High-Polished Chrome Finish



JHW31154 JHW31142



JHW31938

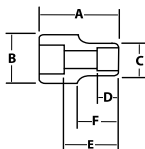

JHW31539 JHW31528



JHW31939



JHWBCF26

JHWBCF32



JHWSBCF-8

Product Code	Size (Inches)	A OAL (Inches)	B Drive End Diameter (Inches)	C Open End Diameter (Inches)	D Broach Depth (Inches)	E Bolt Clearance Depth (Inches)	F Bolt Clearance Diameter (Inches)	Nose Length (Inches)
JHW31142	3/8	1 53/64	3/4	9/16	3/8	35/64	21/64	5/16
JHW31144	7/16	1 53/64	3/4	5/8	3/8	35/64	21/64	5/16
JHW31146	1/2	1 57/64	3/4	45/64	13/32	37/64	21/64	13/32
JHW31148	9/16	1 57/64	3/4	25/32	7/16	43/64	21/64	33/64
JHW31150	5/8	2	3/4	59/64	7/16	45/64	21/64	33/64
JHW31152	11/16	2 3/64	3/4	19/16	3/64	3/4	21/64	17/32
JHW31154	3/4	2 3/64	3/4	1 1/64	1/2	51/64	21/64	17/32

Fed. Spec: ANSI B107.110

JHW31938 7 Piece 6 Point Universal Socket Set on Clip Rail

Contents Include:

Product Code	Size (Inches)	Product Code	Size (Inches)	Product Code	Size (Inches)
JHW31142	3/8	JHW31148	9/16	JHW31154	3/4
JHW31144	7/16	JHW31150	5/8		
JHW31146	1/2	JHW31152	11/16		

Features

- Ideal for work in confined areas where fastener is inaccessible to standard sockets



3/8" DRIVE UNIVERSAL SOCKETS, 6 POINT, METRIC

High-Polished Chrome Finish

Product Code	Size (mm)	A OAL (Inches)	B Drive End Diameter (Inches)	C Open End Diameter (Inches)	D Broach Depth (Inches)	E Bolt Clearance Depth (Inches)	F Bolt Clearance Diameter (Inches)	Nose Length (Inches)
JHW31528	8	1 27/32	3/4	15/32	23/64	35/64	15/64	21/64
JHW31530	10	1 55/64	3/4	9/16	23/64	35/64	21/64	21/64
JHW31531	11	1 59/64	3/4	5/8	23/64	35/64	21/64	21/64
JHW31532	12	1 59/64	3/4	49/64	23/64	35/64	21/64	21/64
JHW31533	13	1 55/64	3/4	45/64	23/64	35/64	21/64	23/64
JHW31534	14	1 15/16	3/4	49/64	25/64	39/64	21/64	1/2
JHW31535	15	1 57/64	3/4	53/64	25/64	39/64	21/64	1/2
JHW31536	16	2	3/4	59/64	7/16	45/64	21/64	1/2
JHW31537	17	2	3/4	19/16	7/16	45/64	21/64	1/2
JHW31538	18	2 1/64	3/4	15/16	15/32	3/4	21/64	1/2
JHW31539	19	2 3/64	3/4	1	1/2	49/64	21/64	1/2

Fed. Spec: ANSI B107.110

JHW31939 11 Piece 6 Point Universal Socket Set on Clip Rail

Contents Include:

Product Code	Size (mm)	Product Code	Size (mm)	Product Code	Size (mm)
JHW31528	8	JHW31533	13	JHW31537	17
JHW31530	10	JHW31534	14	JHW31538	18
JHW31531	11	JHW31535	15	JHW31539	19
JHW31532	12	JHW31536	16		

Features

- Ideal for work in confined areas where fastener is inaccessible to standard sockets



3/8" DRIVE CROWFOOT WRENCH, FLARE NUT, 12 POINT

Satin Chrome Finish, SAE

Product Code	Size (Inches)	A Diameter of Head	B Thickness of Head	C Width of Slot	D Length of Centers
JHWBCF20	5/8	15/16	11/16	15/32	47/64
JHWBCF22	11/16	1 1/32	11/16	17/32	29/32
JHWBCF24	3/4	1 1/8	23/32	9/16	53/64
JHWBCF26	13/16	1 13/64	23/32	5/8	7/8
JHWBCF28	7/8	1 19/64	3/4	11/16	15/16
JHWBCF30	15/16	1 3/8	3/4	23/32	15/16
JHWBCF32	1	1 29/64	25/32	3/4	1 1/64
JHWBCF34	1 1/16	1 17/32	25/32	29/32	1 3/64

Fed. Spec: ASME B107.21 Type 1 Class 1

JHWSBCF-8 8 Piece 12 Point Crowfoot Wrench on Clip Rail

Contents Include:

Product Code	Size (Inches)	Product Code	Size (Inches)	Product Code	Size (Inches)
JHWBCF20	5/8	BCF24	3/4	JHWBCF28	7/8
JHWBCF22	11/16	BCF26	13/16	JHWBCF30	15/16
JHWBCF24	3/4			JHWBCF32	1
				JHWBCF34	1 1/16

3/8" DRIVE CROWFOOT WRENCH, OPEN END, SAE



Satin Chrome Finish, SAE

Product Code	Size (Inches)	A Outside Diameter (Inches)	C Center to Center (Inches)	D Overall Length (Inches)	E Head Depth (Inches)	F Total Depth (Inches)
JHWBCO12	3/8"	7/8	23/32	7/32	33/64	1 19/64
JHWBCO14	7/16"	7/8	41/64	7/32	33/64	1 17/64
JHWBCO16	1/2"	1 1/32	51/64	7/32	33/64	1 29/64
JHWBCO18	9/16"	1 1/4	59/64	7/32	33/64	1 5/8
JHWBCO20	5/8"	1 1/4	55/64	7/32	33/64	1 19/32
JHWBCO22	11/16"	1 9/16	1 3/32	7/32	33/64	1 59/64
JHWBCO24	3/4"	1 9/16	1 1/32	7/32	33/64	1 57/64
JHWBCO26	13/16"	1 23/32	1 3/32	9/32	19/32	2
JHWBCO28	7/8"	1 23/32	1 1/32	9/32	19/32	1 31/32
JHWBCO30	15/16"	2	1 5/32	11/32	21/32	2 1/8
JHWBCO32	1"	2	1 5/64	11/32	21/32	2 3/32
JHWBCO40	1 1/4"	2 5/32	1 15/64	3/8	41/64	2 7/32
JHWBCO44	1 3/8"	2 3/8	1 19/64	3/8	41/64	2 3/8



JHWBCO32



JHWWSBCO-10

JHWWSBCO-10 10 Piece 3/8" Drive Crowfoot Wrenches on Clip Rails, SAE

Contents Include:

Product Code	Size (Inches)	Product Code	Size (Inches)	Product Code	Size (Inches)
JHWBCO12	3/8"	JHWBCO18	9/16"	JHWBCO24	3/4"
JHWBCO14	7/16"	JHWBCO20	5/8"	JHWBCO26	13/16"
JHWBCO16	1/2"	JHWBCO22	11/16"	JHWBCO28	7/8"
				JHWBCO32	1"

Features

- Crowfoot wrenches are professional quality, made of high grade steel
- Featuring an open end with a continuous arc for constant contact with the fastener for greater turning power without deforming the fastener



Made in U.S.A.

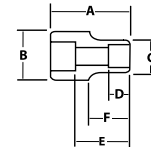

3/8" DRIVE CROWFOOT WRENCH, OPEN END, METRIC



Satin Chrome Finish, MM

Product Code	Size (mm)	A Outside Diameter (Inches)	B Center to Center (Inches)	C Overall Length (Inches)	D Head Depth (Inches)	E Total Depth (Inches)
JHWBCOM10	10	7/8	11/16	1/4	1/2	1 1/4
JHWBCOM11	11	7/8	5/8	1/4	1/2	1 1/4
JHWBCOM12	12	1	13/16	1/4	1/2	1 1/2
JHWBCOM13	13	1	6/8	1/4	1/2	1 1/2
JHWBCOM14	14	1	9/8	1/4	1/2	1 3/8
JHWBCOM15	15	1 1/4	7/8	1/4	1/2	1 5/8
JHWBCOM16	16	1 1/4	7/8	1/4	1/2	1 5/8
JHWBCOM17	17	1 1/4	13/16	1/4	1/2	1 5/8
JHWBCOM18	18	1 1/2	1 1/8	1/4	1/2	1 7/8
JHWBCOM19	19	1 1/2	1	1/4	1/2	1 7/8
JHWBCOM20	20	1 1/2	1	1/4	1/2	1 7/8
JHWBCOM21	21	1 3/4	1 1/8	1/4	5/8	1 7/8
JHWBCOM22	22	1 3/4	1	1/4	5/8	2



JHWBCOM19



JHWWSBCOM-10

JHWWSBCOM-10 10 Piece 3/8" Drive Crowfoot Wrenches on Clip Rails, MM

Contents Include:

Product Code	Size (mm)	Product Code	Size (mm)	Product Code	Size (mm)
JHWBCOM10	10	JHWBCOM13	13	JHWBCOM16	16
JHWBCOM11	11	JHWBCOM14	14	JHWBCOM17	17
JHWBCOM12	12	JHWBCOM15	15	JHWBCOM18	18
				JHWBCOM19	19

Features

- Crowfoot wrenches are professional quality, made of high grade steel
- Featuring an open end with a continuous arc for constant contact with the fastener for greater turning power without deforming the fastener



Made in U.S.A.

3/8" DRIVE

SOCKETS AND DRIVE TOOLS





JHW31612BT

3/8" DRIVE BOLT THRU SOCKETS, 6 POINT, SAE



Product Code	Size (Inches)	Overall Length (Inches)	External Hex Inches
JHW31612BT	3/8	1 7/16	3/4
JHW31614BT	7/16	1 7/16	3/4
JHW31616BT	1/2	1 7/16	3/4
JHW31618BT	9/16	1 7/16	3/4
JHW31620BT	5/8	1 7/16	3/4
JHW31622BT	11/16	1 7/16	3/4
JHW31624BT	3/4	1 7/16	3/4

Features

- SUPERTORQUE™ lobular openings for greater turning power without deforming the fastener
- Designed for quick engagement on both 6 point fasteners



JHW31708BT

3/8" DRIVE BOLT THRU SOCKETS, 6 POINT, METRIC



Product Code	Size (mm)	Overall Length (Inches)	External Hex Inches
JHW31708BT	8	1 7/16	3/4
JHW31709BT	9	1 7/16	3/4
JHW31710BT	10	1 7/16	3/4
JHW31711BT	11	1 7/16	3/4
JHW31712BT	12	1 7/16	3/4
JHW31713BT	13	1 7/16	3/4
JHW31714BT	14	1 7/16	3/4
JHW31715BT	15	1 7/16	3/4
JHW31716BT	16	1 7/16	3/4
JHW31717BT	17	1 7/16	3/4
JHW31718BT	18	1 7/16	3/4
JHW31719BT	19	1 7/16	3/4

Features

- Designed for quick engagement on 6 point fasteners

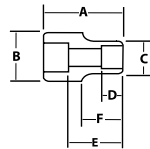

22 PIECE 3/8" DRIVE BOLT THRU SOCKET SET



6 Point Compact Case Tool Set, SAE & MM

Product Code	Description
JHW50671	22 Piece 3/8" Drive Bolt Thru Socket Set

Contents Include:

3/8" Drive Tools:		3/8" Drive Shallow 6-Point Sockets	
Product Code	Description	Product Code	Size (mm)
JHW31018	Locking Flexible Ratchet	JHW31708BT	8
JHW31019	3" Extension	JHW31709BT	9
JHW31020	Adaptor	JHW31710BT	10
		JHW31711BT	11
		JHW31712BT	12
		JHW31713BT	13
		JHW31714BT	14
		JHW31715BT	15
		JHW31716BT	16
		JHW31717BT	17
		JHW31718BT	18
		JHW31719BT	19

Features

- All tools are professional quality, made of high-grade chrome vanadium steel
- Sockets feature SUPERTORQUE™ lobular openings for greater turning power without deforming the fastener
- Packed in rugged compact high-density polyethylene (HDPE) cases that are strong and durable yet light in weight
- Ratchet with 7 locking positions and flex head design



JHW50671

3/8" DRIVE
SOCKETS AND
DRIVE TOOLS



3/8" DRIVE DEEP SOCKETS, 12 POINT, SAE

High-Polished Chrome Finish

Product Code	Size (Inches)	A OAL (Inches)	B Drive End Diameter (Inches)	C Working End Diameter (Inches)	D Broach Depth (Inches)	E Bolt Clearance Depth (Inches)	Bolt Clearance Diameter (Inches)	F Nose Length (Inches)
JHWBD-1208	1/4	2 1/8	1 1/16	1 3/32	7/32	1 11/16	7/32	1 5/8
JHWBD-1210	5/16	2 1/8	1 1/16	1 9/32	1/4	1 11/16	5/16	1 5/8
JHWBD-1212	3/8	2 1/8	1 1/16	9/16	9/32	1 11/16	3/8	1 5/8
JHWBD-1214	7/16	2 1/8	1 1/16	5/8	9/32	1 11/16	7/16	1 5/8
JHWBD-1216	1/2	2 3/8	2 3/32	2 3/32	1 1/32	1 11/32	15/32	-
JHWBD-1218	9/16	2 3/8	2 5/32	2 5/32	9/16	1 9/16	17/32	-
JHWBD-1220	5/8	2 3/8	2 7/32	2 7/32	1 9/16	1 9/16	19/32	-
JHWBD-1222	1 1/16	2 9/8	1 5/16	1 5/16	5/8	1 11/16	2 1/32	-
JHWBD-1224	3/4	2 5/8	1	1	2 1/32	1 11/16	2 3/32	-
JHWBD-1226	13/16	2 3/4	1 1/16	1 1/16	1 1/16	2 1/32	2 5/32	-
JHWBD-1228	7/8	2 3/4	1 5/32	1 5/32	3/4	2 1/32	2 7/32	-
JHWBD-1230	15/16	2 3/4	1 1/4	1 1/4	13/16	2 1/32	2 7/32	-
JHWBD-1232	1	2 3/4	1 5/16	1 5/16	2 7/32	2	3 1/32	-

Fed. Spec: ANSI B107.110



JHWBD-1216 JHWBD-1208

JHWSBD-9RC 9 Piece 3/8" Drive Deep 12 Point Socket Set on Clip Rail

Contents Include:

Product Code	Size (Inches)	Product Code	Size (Inches)	Product Code	Size (Inches)
JHWBD-1212	3/8	JHWBD-1218	9/16	JHWBD-1224	3/4
JHWBD-1214	7/16	JHWBD-1220	5/8	JHWBD-1226	13/16
JHWBD-1216	1/2	JHWBD-1222	1 1/16	JHWBD-1228	7/8

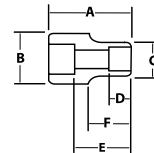

JHWSBD-13RC 13 Piece 3/8" Drive Deep 12 Point Socket Set on Clip Rail

Contents Include:

Product Code	Size (Inches)	Product Code	Size (Inches)	Product Code	Size (Inches)
JHWBD-1208	1/4	JHWBD-1218	9/16	JHWBD-1228	7/8
JHWBD-1210	5/16	JHWBD-1220	5/8	JHWBD-1230	15/16
JHWBD-1212	3/8	JHWBD-1222	1 1/16	JHWBD-1232	1
JHWBD-1214	7/16	JHWBD-1224	3/4		
JHWBD-1216	1/2	JHWBD-1226	13/16		

Features

- SUPERTORQUET™ lobular openings for greater turning power without deforming the fastener
- Designed for quick engagement on both 6 and 12 point fasteners



3/8" DRIVE

SOCKETS AND DRIVE TOOLS



JHWSBD-9RC



JHWSBD-13RC





JHWBD-616

JHWBD-608

3/8" DRIVE DEEP SOCKETS, 6 POINT, SAE



High-Polished Chrome Finish

Product Code	Size (Inches)	Dimensions						
		A	B	C	D	E	F	
		OAL (Inches)	Drive End Diameter (Inches)	Working End Diameter (Inches)	Broach Depth (Inches)	Bolt Clearance Depth (Inches)	Bolt Clearance Diameter (Inches)	Nose Length (Inches)
JHWBD-608	1/4	2 1/8	11/16	13/32	1/4	1 11/16	7/32	1 5/8
JHWBD-610	5/16	2 1/8	11/16	7/16	9/32	1 11/16	5/16	1 5/8
JHWBD-611	11/32	2 1/8	11/16	1/2	1/4	1 11/16	11/32	1 5/8
JHWBD-612	3/8	2 1/8	11/16	9/16	5/16	1 11/16	3/8	1 5/8
JHWBD-614	7/16	2 1/8	11/16	19/32	3/8	1 11/16	7/16	1 5/8
JHWBD-616	1/2	2 1/8	23/32	23/32	7/16	1 11/16	15/32	-
JHWBD-618	9/16	2 3/8	25/32	25/32	7/16	1 9/16	17/32	-
JHWBD-620	5/8	2 3/8	27/32	27/32	1/2	1 9/16	19/32	-
JHWBD-622	11/16	2 5/8	15/16	15/16	17/32	1 3/4	21/32	-
JHWBD-624	3/4	2 5/8	1	1	5/8	1 3/4	23/32	-
JHWBD-626	13/16	2 3/4	1 1/16	1 1/16	11/16	1 27/32	25/32	-
JHWBD-628	7/8	2 3/4	1 5/32	1 5/32	23/32	1 27/32	27/32	-
JHWBD-630	15/16	2 3/4	1 1/4	1 1/4	25/32	2 1/32	27/32	-
JHWBD-632	1	2 3/4	1 9/16	1 9/16	13/16	2 1/32	31/32	-

Fed. Spec: ANSI B107.110

JHWWSBD13HRC 13 Piece 3/8" Drive Deep 6 Point Socket Set on Clip Rail Contents Include:



JHWWSBD13HRC

Product Code	Size (Inches)	Product Code	Size (Inches)	Product Code	Size (Inches)
JHWBD-608	1/4	JHWBD-618	9/16	JHWBD-628	7/8
JHWBD-610	5/16	JHWBD-620	5/8	JHWBD-630	15/16
JHWBD-612	3/8	JHWBD-622	11/16	JHWBD-632	1
JHWBD-614	7/16	JHWBD-624	3/4		
JHWBD-616	1/2	JHWBD-626	13/16		

Features

- SUPERTORQUE™ lobular openings for greater turning power without deforming the fastener
- Designed for maximum engagement on 6 point fasteners

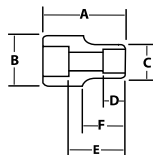

3/8" DRIVE SPARK PLUG SOCKETS, 6 POINT, SAE



High-Polished Chrome Finish

Product Code	Size (Inches)	Dimensions						
		A	B	C	D	E	F	
		OAL (Inches)	Drive End Diameter (Inches)	Working End Diameter (Inches)	Broach Depth (Inches)	Bolt Clearance Depth (Inches)	Bolt Clearance Diameter (Inches)	Nose Length (Inches)
JHW31301	5/8	2 27/32	11/16	27/32	15/32	29/32	11/16	NA
JHW31303	13/16	2 23/32	13/16	1 1/16	15/32	1 1/32	7/8	NA

Fed. Spec: ANSI B107.110

Features

- Rubber insert holds spark plug and prevents damage to insulator



JHW31301

3/8" DRIVE

SOCKETS AND DRIVE TOOLS



3/8" DRIVE SHALLOW SOCKETS, 12 POINT, METRIC

High-Polished Chrome Finish

Product Code	Size (MM)	A	B	C	D	E	Bolt Clearance Diameter (Inches)	Nose Length (Inches)
		OAL (Inches)	Drive End Diameter (Inches)	Working End Diameter (Inches)	Broach Depth (Inches)	Bolt Clearance Depth (Inches)		
JHWBM-1206	6	1 ¹ / ₃₂	1 ¹ / ₁₆	1 ³ / ₃₂	7 ¹ / ₃₂	9 ¹ / ₁₆	7 ¹ / ₃₂	17 ¹ / ₃₂
JHWBM-1207	7	1 ¹ / ₃₂	1 ¹ / ₁₆	1 ³ / ₃₂	7 ¹ / ₃₂	9 ¹ / ₁₆	7 ¹ / ₃₂	17 ¹ / ₃₂
JHWBM-1208	8	1 ¹ / ₃₂	1 ¹ / ₁₆	1 ³ / ₃₂	1 ¹ / ₄	9 ¹ / ₁₆	9 ¹ / ₃₂	17 ¹ / ₃₂
JHWBM-1209	9	1 ¹ / ₃₂	1 ¹ / ₁₆	1 ¹ / ₂	9 ¹ / ₃₂	9 ¹ / ₁₆	1 ¹ / ₃₂	17 ¹ / ₃₂
JHWBM-1210	10	1 ¹ / ₃₂	1 ¹ / ₁₆	9 ¹ / ₁₆	9 ¹ / ₃₂	9 ¹ / ₁₆	1 ¹ / ₃₂	17 ¹ / ₃₂
JHWBM-1211	11	1 ¹ / ₃₂	1 ¹ / ₁₆	5 ¹ / ₈	9 ¹ / ₃₂	9 ¹ / ₁₆	1 ¹ / ₃₂	17 ¹ / ₃₂
JHWBM-1212	12	1 ¹ / ₃₂	1 ¹ / ₁₆	2 ¹ / ₃₂	1 ¹ / ₃₂	9 ¹ / ₁₆	1 ¹ / ₃₂	17 ¹ / ₃₂
JHWBM-1213	13	1 ¹ / ₃₂	2 ³ / ₃₂	2 ³ / ₃₂	1 ¹ / ₃₂	9 ¹ / ₁₆	3 ¹ / ₈	-
JHWBM-1214	14	1 ¹ / ₃₂	2 ³ / ₃₂	2 ³ / ₃₂	7 ¹ / ₁₆	17 ¹ / ₃₂	17 ¹ / ₃₂	-
JHWBM-1215	15	1 ¹ / ₃₂	1 ³ / ₁₆	1 ³ / ₁₆	19 ¹ / ₃₂	19 ¹ / ₃₂	9 ¹ / ₁₆	-
JHWBM-1216	16	1 ¹ / ₈	2 ¹ / ₃₂	2 ¹ / ₃₂	19 ¹ / ₃₂	5 ¹ / ₈	19 ¹ / ₃₂	-
JHWBM-1217	17	1 ¹ / ₃₂	2 ⁹ / ₃₂	2 ⁹ / ₃₂	5 ¹ / ₈	5 ¹ / ₈	5 ¹ / ₈	-
JHWBM-1218	18	1 ¹ / ₃₂	3 ¹ / ₃₂	3 ¹ / ₃₂	5 ¹ / ₈	2 ¹ / ₃₂	1 ¹ / ₁₆	-
JHWBM-1219	19	1 ¹ / ₁₆	1	1	2 ¹ / ₃₂	1 ¹ / ₁₆	2 ³ / ₃₂	-
JHWBM-1220	20	1 ¹ / ₃₂	1 ¹ / ₃₂	1 ¹ / ₃₂	1 ¹ / ₁₆	2 ³ / ₃₂	3 ¹ / ₄	-
JHWBM-1221	21	1 ¹ / ₄	1 ¹ / ₈	1 ¹ / ₈	2 ³ / ₃₂	2 ³ / ₃₂	3 ¹ / ₁₆	-
JHWBM-1222	22	1 ⁹ / ₃₂	1 ⁹ / ₃₂	1 ⁹ / ₃₂	3 ¹ / ₄	3 ¹ / ₄	3 ¹ / ₁₆	-
JHWBM-1223	23	1 ⁵ / ₁₆	1 ³ / ₁₆	1 ³ / ₁₆	3 ¹ / ₄	2 ⁵ / ₃₂	7 ¹ / ₈	-
JHWBM-1224	24	1 ³ / ₈	1 ¹ / ₄	1 ¹ / ₄	1 ³ / ₁₆	2 ⁷ / ₃₂	7 ¹ / ₈	-
JHWBM-1226	26	1 ⁷ / ₁₆	1 ¹ / ₃₂	1 ¹ / ₃₂	2 ⁷ / ₃₂	7 ¹ / ₈	1 ⁵ / ₁₆	-

Fed. Spec: ANSI B107.110



JHWBM-1212

JHWBM-1206

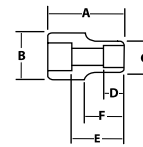

JHWMSB-12RC 12 Piece 3/8" Drive Shallow 12 Point Socket Set on Clip Rail

Contents Include:

Product Code	Size (MM)	Product Code	Size (MM)	Product Code	Size (MM)
JHWBM-1208	8	JHWBM-1212	12	JHWBM-1216	16
JHWBM-1209	9	JHWBM-1213	13	JHWBM-1217	17
JHWBM-1210	10	JHWBM-1214	14	JHWBM-1218	18
JHWBM-1211	11	JHWBM-1215	15	JHWBM-1219	19



JHWMSB-12RC

JHWMSB-17RC 17 Piece 3/8" Drive Shallow 12 Point Socket Set on Clip Rail

Contents Include:

Product Code	Size (MM)	Product Code	Size (MM)	Product Code	Size (MM)	Product Code	Size (MM)
JHWBM-1206	6	JHWBM-1211	11	JHWBM-1216	16	JHWBM-1221	21
JHWBM-1207	7	JHWBM-1212	12	JHWBM-1217	17	JHWBM-1222	22
JHWBM-1208	8	JHWBM-1213	13	JHWBM-1218	18		
JHWBM-1209	9	JHWBM-1214	14	JHWBM-1219	19		
JHWBM-1210	10	JHWBM-1215	15	JHWBM-1220	20		



JHWMSB-17RC

JHWMSB-20RC 20 Piece 3/8" Drive Shallow 12 Point Socket Set on Clip Rail

Contents Include:

Product Code	Size (MM)	Product Code	Size (MM)	Product Code	Size (MM)	Product Code	Size (MM)
JHWBM-1206	6	JHWBM-1211	11	JHWBM-1216	16	JHWBM-1221	21
JHWBM-1207	7	JHWBM-1212	12	JHWBM-1217	17	JHWBM-1222	22
JHWBM-1208	8	JHWBM-1213	13	JHWBM-1218	18	JHWBM-1223	23
JHWBM-1209	9	JHWBM-1214	14	JHWBM-1219	19	JHWBM-1224	24
JHWBM-1210	10	JHWBM-1215	15	JHWBM-1220	20	JHWBM-1226	26



JHWMSB-20RC

Features

- SUPERTORQUE™ lobular openings for greater turning power without deforming the fastener
- Designed for quick engagement on both 6 and 12 point fasteners



3/8" DRIVE

SOCKETS AND DRIVE TOOLS





3/8" DRIVE SHALLOW SOCKETS, 6 POINT, METRIC

High-Polished Chrome Finish



JHWBM-612

JHWBM-606

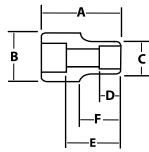

Product Code	Size (MM)	A		B		C		D		E		F
		OAL (Inches)	Drive End Diameter (Inches)	Working End Diameter (Inches)	Broach Depth (Inches)	Bolt Clearance Depth (Inches)	Bolt Clearance Diameter (Inches)	Nose Length (Inches)				
JHWBM-605.5	5 1/2	1 1/32	11/16	13/32	7/32	9/16	3/16	17/32				
JHWBM-606	6	1 1/32	11/16	13/32	7/32	9/16	7/32	17/32				
JHWBM-607	7	1 1/32	11/16	13/32	7/32	9/16	7/32	17/32				
JHWBM-608	8	1 1/32	11/16	13/32	1/4	9/16	9/32	17/32				
JHWBM-609	9	1 1/32	11/16	1/2	9/32	9/16	11/32	17/32				
JHWBM-610	10	1 1/32	11/16	9/16	9/32	9/16	11/32	17/32				
JHWBM-611	11	1 1/32	11/16	5/8	9/32	9/16	11/32	17/32				
JHWBM-612	12	1 1/32	11/16	21/32	11/32	9/16	11/32	17/32				
JHWBM-613	13	1 1/32	23/32	23/32	11/32	9/16	3/8	-				
JHWBM-614	14	1 1/32	25/32	25/32	7/16	17/32	17/32	-				
JHWBM-615	15	1 3/32	13/16	19/16	19/32	19/32	9/16	-				
JHWBM-616	16	1 1/8	27/32	27/32	19/32	5/8	19/32	-				
JHWBM-617	17	1 5/32	29/32	29/32	5/8	5/8	5/8	-				
JHWBM-618	18	1 5/32	31/32	31/32	5/8	21/32	11/16	-				
JHWBM-619	19	1 3/16	1	1	21/32	11/16	23/32	-				
JHWBM-620	20	1 7/32	1 1/32	1 1/32	11/16	23/32	3/4	-				
JHWBM-621	21	1 1/4	1 1/8	1 1/8	23/32	23/32	3/16	-				
JHWBM-622	22	1 9/32	1 5/32	1 5/32	3/4	3/4	3/16	-				
JHWBM-623	23	1 5/16	1 9/16	1 3/16	3/4	25/32	7/8	-				
JHWBM-624	24	1 3/8	1 1/4	1 1/4	13/16	27/32	7/8	-				
JHWBM-626	26	1 7/16	1 11/32	1 11/32	27/32	7/8	15/16	-				

Fed. Spec: ANSI B107.110

JHWMSB-12HRC

12 Piece 3/8" Drive Shallow 6 Point Socket Set on Clip Rail

Contents Include:

Product Code	Size (MM)	Product Code	Size (MM)	Product Code	Size (MM)
JHWBM-608	8	JHWBM-612	12	JHWBM-616	16
JHWBM-609	9	JHWBM-613	13	JHWBM-617	17
JHWBM-610	10	JHWBM-614	14	JHWBM-618	18
JHWBM-611	11	JHWBM-615	15	JHWBM-619	19

JHWMSB-20HRC

20 Piece 3/8" Drive Shallow 6 Point Socket Set on Clip Rail

Contents Include:

Product Code	Size (MM)	Product Code	Size (MM)	Product Code	Size (MM)	Product Code	Size (MM)
JHWBM-605.5	5 1/2	JHWBM-610	10	JHWBM-615	15	JHWBM-620	20
JHWBM-606	6	JHWBM-611	11	JHWBM-616	16	JHWBM-621	21
JHWBM-607	7	JHWBM-612	12	JHWBM-617	17	JHWBM-622	22
JHWBM-608	8	JHWBM-613	13	JHWBM-618	18	JHWBM-623	23
JHWBM-609	9	JHWBM-614	14	JHWBM-619	19	JHWBM-624	24

Features

- SUPERTORQUE™ lobular openings for greater turning power without deforming the fastener
- Designed for maximum engagement on 6 point fasteners



JHWMSB-12HRC



JHWMSB-20RC

3/8" DRIVE

SOCKETS AND DRIVE TOOLS



3/8" DRIVE DEEP SOCKETS, 6 POINT, METRIC

High-Polished Chrome Finish

Product Code	Size (MM)	A	B	C	D	E	Bolt Clearance Diameter (Inches)	Nose Length (Inches)
		OAL (Inches)	Drive End Diameter (Inches)	Working End Diameter (Inches)	Broach Depth (Inches)	Bolt Clearance Depth (Inches)		
JHWBMD-606	6	2 1/8	1 1/16	1 3/32	7/32	1 11/16	7/32	1 5/8
JHWBMD-607	7	2 1/8	1 1/16	1 3/32	9/32	1 11/16	1/4	1 5/8
JHWBMD-608	8	2 1/8	1 1/16	1 5/32	9/32	1 11/16	5/16	1 5/8
JHWBMD-609	9	2 1/8	1 1/16	1/2	9/32	1 11/16	11/32	1 5/8
JHWBMD-610	10	2 1/8	1 1/16	9/16	5/16	1 11/16	3/8	1 5/8
JHWBMD-611	11	2 1/8	1 1/16	5/8	3/8	1 11/16	7/16	1 5/8
JHWBMD-612	12	2 1/8	1 1/16	21/32	13/32	1 11/16	15/32	1 5/8
JHWBMD-613	13	2 1/8	23/32	23/32	13/32	1 5/8	17/32	-
JHWBMD-614	14	2 3/8	25/32	25/32	13/32	1 9/16	17/32	-
JHWBMD-615	15	2 3/8	13/16	13/16	13/32	1 9/16	17/32	-
JHWBMD-616	16	2 3/8	27/32	27/32	13/32	1 9/16	19/32	-
JHWBMD-617	17	2 21/32	29/32	29/32	1/2	1 13/16	5/8	-
JHWBMD-618	18	2 21/32	31/32	31/32	1/2	1 13/16	21/32	-
JHWBMD-619	19	2 21/32	1	1	5/8	1 13/16	23/32	-
JHWBMD-620	20	2 21/32	1 1/32	1 1/32	5/8	1 13/16	25/32	-
JHWBMD-622	22	2 7/8	1 5/32	1 5/32	5/8	2 5/32	7/8	-
JHWBMD-623	23	2 7/8	1 3/16	1 3/16	1/2	2 3/32	27/32	-
JHWBMD-624	24	2 7/8	1 1/4	1 1/4	9/16	2 5/32	15/16	-
JHWBMD-625	25	2 7/8	1 9/32	1 9/32	9/16	2 1/8	31/32	-

Fed. Spec: ANSI B107.110



JHWBMD-612

JHWBMD-606

JHWMSBD12HRC 12 Piece 3/8" Drive Deep 6 Point Socket Set on Clip Rail

Contents Include:

Product Code	Size (MM)	Product Code	Size (MM)	Product Code	Size (MM)
JHWBMD-608	8	JHWBMD-612	12	JHWBMD-616	16
JHWBMD-609	9	JHWBMD-613	13	JHWBMD-617	17
JHWBMD-610	10	JHWBMD-614	14	JHWBMD-618	18
JHWBMD-611	11	JHWBMD-615	15	JHWBMD-619	19

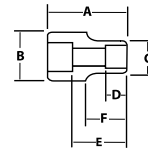

JHWMSBD19HRC 19 Piece 3/8" Drive Deep 6 Point Socket Set on Clip Rail

Contents Include:

Product Code	Size (MM)	Product Code	Size (MM)	Product Code	Size (MM)	Product Code	Size (MM)
JHWBMD-606	6	JHWBMD-611	11	JHWBMD-616	16	JHWBMD-622	22
JHWBMD-607	7	JHWBMD-612	12	JHWBMD-617	17	JHWBMD-623	23
JHWBMD-608	8	JHWBMD-613	13	JHWBMD-618	18	JHWBMD-624	24
JHWBMD-609	9	JHWBMD-614	14	JHWBMD-619	19	JHWBMD-625	25
JHWBMD-610	10	JHWBMD-615	15	JHWBMD-620	20		

Features

- SUPERTORQUET™ lobular openings for greater turning power without deforming the fastener
- Designed for maximum engagement on 6 point fasteners



JHWMSBD12HRC



JHWMSBD19HRC

3/8" DRIVE

SOCKETS AND DRIVE TOOLS





JHW31812

JHW31806

3/8" DRIVE DEEP SOCKETS, 12 POINT, METRIC



High-Polished Chrome Finish

Product Code	Size (MM)	A	B	C	D	E	F	
		OAL (Inches)	Drive End Diameter (Inches)	Working End Diameter (Inches)	Broach Depth (Inches)	Bolt Clearance Depth (Inches)	Bolt Clearance Diameter (Inches)	Nose Length (Inches)
JHW31806	6	2 1/2	11/16	3/8	5/8	1 9/16	7/32	1 7/32
JHW31807	7	2 1/2	11/16	7/16	5/8	1 9/16	1/4	1 7/32
JHW31808	8	2 1/2	11/16	7/16	5/8	1 9/16	9/32	1 7/32
JHW31809	9	2 1/2	11/16	17/32	5/8	1 9/16	5/16	1 7/32
JHW31810	10	2 1/2	11/16	9/16	1	1 11/16	3/8	1 7/32
JHW31811	11	2 1/2	11/16	5/8	1	1 25/32	13/32	1 7/32
JHW31812	12	2 1/2	11/16	11/16	1	1 25/32	7/16	-
JHW31813	13	2 1/2	23/32	23/32	1	1 31/32	1/2	-
JHW31814	14	2 1/2	3/4	3/4	1	2	17/32	-
JHW31815	15	2 1/2	13/16	13/16	1	1 15/16	9/16	-
JHW31816	16	2 1/2	7/8	7/8	1	1 29/32	19/32	-
JHW31817	17	2 1/2	15/16	15/16	1	2	21/32	-
JHW31818	18	2 1/2	31/32	31/32	1 1/16	1 29/32	11/16	-
JHW31819	19	2 1/2	1	1	1 3/32	1 31/32	23/32	-

Fed. Spec: ANSI B107.110

JHW31934 8 Piece 3/8" Drive Deep 12 Point Socket Set on Clip Rail

Contents Include:

Product Code	Size (MM)	Product Code	Size (MM)	Product Code	Size (MM)
JHW31810	10	JHW31813	13	JHW31816	16
JHW31811	11	JHW31814	14	JHW31817	17
JHW31812	12	JHW31815	15		

JHW31936 14 Piece 3/8" Drive Deep 12 Point Socket Set on Clip Rail

Contents Include:

Product Code	Size (MM)	Product Code	Size (MM)	Product Code	Size (MM)
JHW31806	6	JHW31811	11	JHW31816	16
JHW31807	7	JHW31812	12	JHW31817	17
JHW31808	8	JHW31813	13	JHW31818	18
JHW31809	9	JHW31814	14	JHW31819	19
JHW31810	10	JHW31815	15		

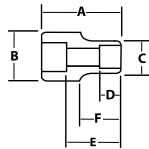

Features

- SUPERTORQUE™ lobular openings for greater turning power without deforming the fastener
- Designed for quick engagement on both 6 and 12 point fasteners



JHW31934



JHW31936

3/8" DRIVE

SOCKETS AND
DRIVE TOOLS

3/8" DRIVE TURBOSOCKET® SALVAGE/DAMAGED FASTENER SOCKETS



Black Industrial Finish, Metric and SAE

Product Code	Size (Inches)	A (Inches)	B (Inches)	C (Inches)	D (Inches)	E (Inches)	F (Inches)	Nose Length (Inches)
JHWTS38375	3/8	1 1/4	1 1/16	1 9/32	1 13/32	3/4	3/8	1 1/16
JHWTS38437	7/16	1 1/4	1 1/16	2 1/32	1 1/2	3/4	7/16	1 1/16
JHWTS38500	1/2	1 1/4	3/4	3/4	1 1/2	3/4	1/2	-
JHWTS38562	9/16	1 1/4	13/16	13/16	1 1/2	23/32	9/16	-
JHWTS38625	5/8	1 1/4	29/32	29/32	1 1/2	19/32	5/8	-
JHWTS38687	1 1/16	1 13/32	3 1/32	3 1/32	2 1/32	29/32	23/32	-
JHWTS38750	3/4	1 13/32	1 1/16	1 1/16	2 1/32	29/32	3/4	-



JHWTS38687

Product Code	Size (MM)	OAL (Inches)	Drive End Diameter (Inches)	Working End Diameter (Inches)	Broach Depth (Inches)	Bolt Clearance Depth (Inches)	Bolt Clearance Diameter (Inches)	Nose Length (Inches)
JHWTS38394	10	1 1/4	1 1/16	5/8	1 13/32	3/4	1 13/32	1 1/16
JHWTS38472	12	1 1/4	23/32	23/32	1 1/2	3/4	1 15/32	-
JHWTS38512	13	1 1/4	3/4	3/4	1 1/2	3/4	1 17/32	-
JHWTS38551	14	1 1/4	13/16	13/16	1 1/2	23/32	9/16	-
JHWTS38591	15	1 1/4	27/32	27/32	1 1/2	19/32	1 19/32	-
JHWTS38669	17	1 13/32	3 1/32	3 1/32	2 1/32	29/32	2 23/32	-

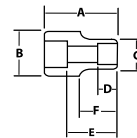

JHWTSFS3807 7 Piece TURBOSOCKET® Salvage Socket Set on Clip Rail, SAE

Contents Include:

Product Code	Size (Inches)	Product Code	Size (Inches)	Product Code	Size (Inches)
JHWTS38375	3/8	JHWTS38562	9/16	JHWTS38750	3/4
JHWTS38437	7/16	JHWTS38625	5/8		
JHWTS38500	1/2	JHWTS38687	1 1/16		

JHWTS3813 13 Piece TURBOSOCKET® Salvage Socket Set on Clip Rail, SAE and Metric

Contents Include:

Product Code	Size (Inches)	Product Code	Size (MM)
JHWTS38375	3/8	JHWTS38394	10
JHWTS38437	7/16	JHWTS38472	12
JHWTS38500	1/2	JHWTS38512	13
JHWTS38562	9/16	JHWTS38551	14
JHWTS38625	5/8	JHWTS38591	15
JHWTS38687	1 1/16	JHWTS38669	17
JHWTS38750	3/4		



JHWTS38669

JHWTSMS3809 9 Piece TURBOSOCKET® Salvage Socket Set on Clip Rail, Metric

Contents Include:

Product Code	Size (MM)	Product Code	Size (MM)	Product Code	Size (MM)
JHWTS38394	10	JHWTS38512	13	JHWTS38625	16 (5/8")
JHWTS38437	11 (7/16")	JHWTS38551	14	JHWTS38669	17
JHWTS38472	12	JHWTS38591	15	JHWTS38750	19 (3/4")

Features

- Quickly and easily remove damaged or rounded nuts and bolts
- Place socket on fastener and turn with ratchet, breaker bar or T-handle
- Grip on fastener tightens as more torque is applied
- No hammering is required to install socket over fastener
- Use on all types of standard nuts and bolts as well as studs, pipe nipples, and corroded auto and marine fasteners
- May be used for "best fit" on metric and fractional fasteners
- May be used with air or electric impact wrench for extra speed and turning power



JHWTSFS3807



JHWTS3813



JHWTSMS3809

3/8" DRIVE

SOCKETS AND DRIVE TOOLS





3/8" DRIVE STANDARD LENGTH HEX BIT SOCKETS, METRIC

High-Polished Chrome Finish

Product Code	Size (MM)	Socket Length (Inches)	Socket Outside Diameter (Inches)	Overall Length (Inches)	Bit Length (Inches)
JHW35170	4	1 3/16	3/4	1 27/32	2 1/32
JHW35171	5	1 3/16	3/4	1 27/32	2 1/32
JHW35172	6	1 3/16	3/4	1 27/32	2 1/32
JHW35173	7	1 3/16	3/4	1 27/32	2 1/32
JHW35174	8	1 3/16	3/4	1 31/32	13/16
JHW35175	9	1 3/16	3/4	1 31/32	13/16
JHW35176	10	1 3/16	3/4	1 31/32	13/16



JHW35170



JHW31904

JHW31904 7 Piece Hex Bit Socket Set on Clip Rail

Contents Include:

Product Code	Size (MM)	Product Code	Size (MM)	Product Code	Size (MM)
JHW35170	4	JHW35173	7	JHW35176	10
JHW35171	5	JHW35174	8		
JHW35172	6	JHW35175	9		

Features

- High-polished chrome finish socket cleans easily



3/8" DRIVE BALL TIP HEX BIT SOCKETS, SAE

High-Polished Chrome Finish

Product Code	Size (Inches)	Socket Length (Inches)	Socket Outside Diameter (Inches)	Overall Length (Inches)	Replacement Bit Product Code
JHWBA-3HBA	3/32	1 1/16	11/16	1 27/32	JHWBITHB03T01
JHWBA-4HBA	1/8	1 1/16	11/16	1 7/8	JHWBITHB0402
JHWBA-5HBA	5/32	1 1/16	11/16	1 7/8	JHWBITHB0502
JHWBA-6HBA	3/16	1 1/16	11/16	1 7/8	JHWBITHB0602
JHWBA-7HBA	7/32	1 1/16	11/16	1 7/8	JHWBITHB0702
JHWBA-8HBA	1/4	1 1/16	11/16	1 7/8	JHWBITHB0802
JHWBA-10HBA	5/16	1 1/16	11/16	1 7/8	JHWBITHB1001
JHWBA-12HBA	3/8	1 1/16	23/32	1 7/8	JHWBITHB1201



JHWBA-7HBA



JHWSBB-7RC

JHWSBB-7RC 7 Piece Ball Tip Hex Bit Socket Set on Clip Rail

Contents Include:

Product Code	Size (Inches)	Product Code	Size (Inches)	Product Code	Size (Inches)
JHWBA-4HBA	1/8	JHWBA-7HBA	7/32	JHWBA-12HBA	3/8
JHWBA-5HBA	5/32	JHWBA-8HBA	1/4		
JHWBA-6HBA	3/16	JHWBA-10HBA	5/16		

Features

- High-polished chrome finish socket cleans easily
- Two piece design allows bits to be replaced easily



3/8" DRIVE STANDARD LENGTH HEX BIT SOCKETS, SAE

High-Polished Chrome Finish

Product Code	Size (Inches)	Socket Length (Inches)	Socket Outside Diameter (Inches)	Overall Length (Inches)	Replacement Bit Product Code
JHWBA-3A	3/32	1 1/16	11/16	1 27/32	JHWBITH03T01
JHWBA-4A	1/8	1 1/16	11/16	1 7/8	JHWBITH0403
JHWBA-5A	5/32	1 1/16	11/16	1 7/8	JHWBITH0503
JHWBA-6A	3/16	1 1/16	11/16	1 7/8	JHWBITH0603
JHWBA-7A	7/32	1 1/16	11/16	1 7/8	JHWBITH0703
JHWBA-8A	1/4	1 1/16	11/16	1 7/8	JHWBITH0803
JHWBA-10A	5/16	1 1/16	11/16	1 7/8	JHWBITH1003
JHWBA-12A	3/8	1 1/16	23/32	1 7/8	JHWBITH1201



JHWBA-7A



JHWSB-7A

JHWSB-7A 7 Piece Hex Bit Socket Set on Clip Rail

Contents Include:

Product Code	Size (Inches)	Product Code	Size (Inches)
JHWBA-4A	1/8	JHWBA-8A	1/4
JHWBA-5A	5/32	JHWBA-10A	5/16
JHWBA-6A	3/16	JHWBA-12A	3/8
JHWBA-7A	7/32		

JHWSBS-10RC 10 Piece Hex Bit Socket Set on Clip Rail, 3/8" & 1/2" Drive

Contents Include:

3/8" Drive		3/8" Drive		1/2" Drive	
Product Code	Size (Inches)	Product Code	Size (Inches)	Product Code	Size (Inches)
JHWBA-4A	1/8	JHWBA-8A	1/4	JHWSA-16A	1/2
JHWBA-5A	5/32	JHWBA-10A	5/16	JHWSA-18A	9/16
JHWBA-6A	3/16	JHWBA-12A	3/8	JHWSA-20A	5/8
JHWBA-7A	7/32				



JHWSBS-10RC

Features

- High-polished chrome finish socket cleans easily
- Two piece design allows bits to be replaced easily



3/8" DRIVE

SOCKETS AND
DRIVE TOOLS



3/8" DRIVE LONG HEX BIT SOCKETS, SAE

High-Polished Chrome Finish

Product Code	Size (Inches)	Socket Length (Inches)	Socket Outside Diameter (Inches)	Overall Length (Inches)	Replacement Bit Product Code
JHWBA-3LA	3/32	1 1/16	1 1/16	3 3/4	JHWBITH03T02
JHWBA-4LA	1/8	1 1/16	1 1/16	3 3/4	JHWBITH0404
JHWBA-5LA	5/32	1 1/16	1 1/16	3 3/4	JHWBITH0504
JHWBA-6LA	3/16	1 1/16	1 1/16	3 3/4	JHWBITH0604
JHWBA-7LA	7/32	1 1/16	1 1/16	3 3/4	JHWBITH0704
JHWBA-8LA	1/4	1 1/16	1 1/16	3 3/4	JHWBITH0804
JHWBA-10LA	5/16	1 1/16	1 1/16	3 3/4	JHWBITH1004
JHWBA-12LA	3/8	1 1/16	23/32	3 3/4	JHWBITH1202

JHWBA-7LA



JHWSBS-7LRC 7 Piece Long Hex Bit Socket Set on Clip Rail

Contents Include:

Product Code	Size (Inches)	Product Code	Size (Inches)	Product Code	Size (Inches)
JHWBA-4LA	1/8	JHWBA-7LA	7/32	JHWBA-12LA	3/8
JHWBA-5LA	5/32	JHWBA-8LA	1/4		
JHWBA-6LA	3/16	JHWBA-10LA	5/16		



JHWSBS-7LRC

Features

- High-polished chrome finish socket cleans easily
- Two piece design allows bits to be replaced easily



Made in U.S.A.

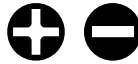

3/8" DRIVE SCREWDRIVER BIT SOCKETS

High-Polished Chrome Finish, Phillips® and Slotted

Product Code	Size (Inches)	Socket Length (Inches)	Socket Outside Diameter (Inches)	Overall Length (Inches)	Replacement Bit Product Code
Slotted Bits:					
JHWBA-5A-1S	3/16 x .032	1 1/16	1 1/16	1 13/16	JHWBITS01
JHWBA-7A-2S	7/32 x .039	1 1/16	1 1/16	1 13/16	JHWBITS02
JHWBA-10A-3S	9/32 x .047	1 1/16	1 1/16	1 7/8	JHWBITS04
JHWBA-10A-4S	5/16 x .061	1 1/16	1 1/16	1 7/8	JHWBITS05
Phillips® Bits:					
JHWBA-7A-1P	1	1 1/16	1 1/16	1 7/8	JHWBITPH0102
JHWBA-7A-2P	2	1 1/16	1 1/16	1 7/8	JHWBITPH0202
JHWBA-10A-3P	3	1 1/16	1 1/16	1 7/8	JHWBITPH0302
JHWBA-12A-4P	4	1 1/16	23/32	1 7/8	JHWBITPH0401

JHWBA-7A-2S

JHWBA-7A-2P



JHWSBSP-8RC 8 Piece Screwdriver Bit Socket Set on Clip Rail

Contents Include:

Product Code	Tip Size	Product Code	Tip Size	Product Code	Tip Size	Product Code	Tip Size
JHWBA-5A-1S	3/16 x .032	JHWBA-10A-3S	9/32 x .047	JHWBA-7A-1P	1	JHWBA-10A-3P	3
JHWBA-7A-2S	7/32 x .039	JHWBA-10A-4S	5/16 x .061	JHWBA-7A-2P	2	JHWBA-12A-4P	4



JHWSBSP-8RC

Features

- High-polished chrome finish socket cleans easily
- Two piece design allows bits to be replaced easily



Made in U.S.A.

3/8" DRIVE LONG LENGTH HEX BIT SOCKETS, METRIC



High-Polished Chrome Finish

Product Code	Size (MM)	Socket Length (Inches)	Socket Outside Diameter (Inches)	Overall Length (Inches)
JHW35164	4	1 3/16	3/4	6
JHW35165	5	1 3/16	3/4	6
JHW35166	6	1 3/16	3/4	6
JHW35167	7	1 3/16	3/4	6
JHW35168	8	1 3/16	3/4	6
JHW35169	9	1 3/16	3/4	6
JHW35163	10	1 3/16	3/4	6

JHW35164



JHW31951 7 Piece Hex Bit Socket Set on Clip Rail

Contents Include:

Product Code	Size (MM)	Product Code	Size (MM)	Product Code	Size (MM)
JHW35164	4	JHW35167	7	JHW35163	10
JHW35165	5	JHW35168	8		
JHW35166	6	JHW35169	9		



JHW31951

Features

- High-polished chrome finish socket cleans easily



3/8" DRIVE LONG BALL TIP HEX BIT SOCKETS, SAE



JHW35130



JHW31947

High-Polished Chrome Finish

Product Code	Size (Inches)	Socket Length (Inches)	Socket Outside Diameter (Inches)	Overall Length (Inches)
JHW35130	1/8	1 3/16	3/4	5
JHW35131	9/64	1 3/16	3/4	5
JHW35132	5/32	1 3/16	3/4	5
JHW35133	3/16	1 3/16	3/4	5
JHW35134	7/32	1 3/16	3/4	5
JHW35135	1/4	1 3/16	3/4	5
JHW35136	5/16	1 3/16	3/4	5
JHW35137	3/8	1 3/16	3/4	5

JHW31947 8 Piece Ball Tip Hex Bit Socket Set on Clip Rail

Contents Include:

Product Code	Size (Inches)	Product Code	Size (Inches)	Product Code	Size (Inches)
JHW35130	1/8	JHW35133	3/16	JHW35136	5/16
JHW35131	9/64	JHW35134	7/32	JHW35137	3/8
JHW35132	5/32	JHW35135	1/4		

Features

- High-polished chrome finish socket cleans easily

3/8" DRIVE TORX® BIT SOCKETS



JHW35182



JHW31910

High-Polished Chrome Finish

Product Code	Torx® Size	Socket Length (Inches)	Socket Outside Diameter (Inches)	Overall Length (Inches)	Bit Length (Inches)
JHW35182	T25	1 3/16	3/4	1 27/32	1 1/16
JHW35183	T27	1 3/16	3/4	1 27/32	1 1/16
JHW35184	T30	1 3/16	3/4	1 27/32	1 1/16
JHW35185	T40	1 3/16	3/4	1 31/32	1 3/16
JHW35186	T45	1 3/16	3/4	1 31/32	1 3/16
JHW35187	T47	1 3/16	3/4	2	1 3/16
JHW35188	T50	1 3/16	3/4	2	1 3/16

JHW31910 7 Piece Torx® Bit Socket Set on Clip Rail

Contents Include:

Product Code	Torx® Size	Product Code	Torx® Size	Product Code	Torx® Size
JHW35182	T25	JHW35185	T40	JHW35188	T50
JHW35183	T27	JHW35186	T45		
JHW35184	T30	JHW35187	T47		

Features

- High-polished chrome finish socket cleans easily

3/8" DRIVE TAMPER-RESISTANT TORX® BIT SOCKETS



JHW35192



JHW31912

High-Polished Chrome Finish

Product Code	Torx® Size	Socket Length (Inches)	Socket Outside Diameter (Inches)	Overall Length (Inches)	Bit Length (Inches)
JHW35192	T25	1 3/16	3/4	1 27/32	2 1/32
JHW35193	T27	1 3/16	3/4	1 27/32	2 1/32
JHW35194	T30	1 3/16	3/4	1 27/32	2 1/32
JHW35195	T40	1 3/16	3/4	1 31/32	1 9/16
JHW35196	T45	1 3/16	3/4	1 31/32	1 9/16
JHW35197	T47	1 3/16	3/4	1 31/32	1 9/16
JHW35198	T50	1 3/16	3/4	1 31/32	1 9/16

JHW31912 7 Piece Tamper-Resistant Torx® Bit Socket Set on Clip Rail

Contents Include:

Product Code	Torx® Size	Product Code	Torx® Size	Product Code	Torx® Size
JHW35192	T25	JHW35195	T40	JHW35198	T50
JHW35193	T27	JHW35196	T45		
JHW35194	T30	JHW35197	T47		

Features

- High-polished chrome finish socket cleans easily

3/8" DRIVE SOCKET FLEXTENSIONS

Williams Flexextension are used extensively in engine and heavy equipment manufacturing, assembly and repair. They increase productivity by featuring an integrated (non-removable) design of the drive extension and socket to allow for reliable, continuous work without concern for the socket disconnecting from the extension as could happen with hand-tool type ball retained sockets.

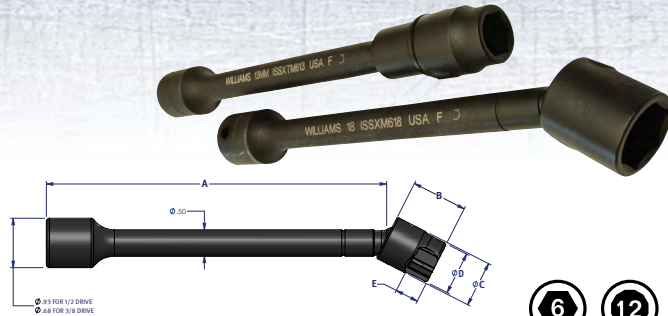

3/8" DRIVE SOCKET FLEXTENSIONS, SAE

Black Industrial Finish

Product Code	Drive	A			Socket Points	Socket (SAE)	B		C	D	E
		Shank Length	Tension	Socket Points			Socket Length	Socket Diameter	Nose Diameter	Hex Depth	
JHWISFXT412	3/8"	4.57"/116.1MM	Yes	6	3/8"	1.06"/26.9MM	0.90"/22.7MM	0.63"/16.0MM	0.28"/7.1MM	1.1MM	
JHWISFX412	3/8"	4.57"/116.1MM	No	6	3/8"	1.06"/26.9MM	0.90"/22.7MM	0.63"/16.0MM	0.28"/7.1MM	1.1MM	
JHWISFXTD612	3/8"	6.57"/166.9MM	Yes	12	3/8"	0.81"/20.6MM	0.75"/19.1MM	0.60"/15.2MM	0.41"/10.4MM	1.4MM	
JHWISFXT612	3/8"	6.57"/166.9MM	Yes	6	3/8"	1.06"/26.9MM	0.90"/22.7MM	0.63"/16.0MM	0.28"/7.1MM	1.1MM	
JHWISFX612	3/8"	6.57"/166.9MM	No	6	3/8"	1.06"/26.9MM	0.90"/22.7MM	0.63"/16.0MM	0.28"/7.1MM	1.1MM	
JHWISFXT1212	3/8"	12.57"/319.3MM	Yes	6	3/8"	1.06"/26.9MM	0.90"/22.7MM	0.63"/16.0MM	0.28"/7.1MM	1.1MM	
JHWISFXT414	3/8"	4.57"/116.1MM	Yes	6	7/16"	1.06"/26.9MM	0.90"/22.7MM	0.76"/19.3MM	0.37"/9.6MM	1.2MM	
JHWISFX414	3/8"	4.57"/116.1MM	No	6	7/16"	1.06"/26.9MM	0.90"/22.7MM	0.76"/19.3MM	0.37"/9.6MM	1.2MM	
JHWISFXT614	3/8"	6.57"/166.9MM	Yes	6	7/16"	1.06"/26.9MM	0.90"/22.7MM	0.76"/19.3MM	0.37"/9.6MM	1.2MM	
JHWISFX614	3/8"	6.57"/166.9MM	No	6	7/16"	1.06"/26.9MM	0.90"/22.7MM	0.76"/19.3MM	0.37"/9.6MM	1.2MM	
JHWISFXT416	3/8"	4.57"/116.1MM	Yes	6	1/2"	1.06"/26.9MM	0.90"/22.7MM	0.76"/19.3MM	0.34"/8.6MM	1.3MM	
JHWISFX416	3/8"	4.57"/116.1MM	No	6	1/2"	1.06"/26.9MM	0.90"/22.7MM	0.76"/19.3MM	0.34"/8.6MM	1.3MM	
JHWISFXT616	3/8"	6.57"/166.9MM	Yes	6	1/2"	1.06"/26.9MM	0.90"/22.7MM	0.76"/19.3MM	0.34"/8.6MM	1.3MM	
JHWISFX616	3/8"	6.57"/166.9MM	No	6	1/2"	1.06"/26.9MM	0.90"/22.7MM	0.76"/19.3MM	0.34"/8.6MM	1.3MM	
JHWISFXT1216	3/8"	12.57"/319.3MM	Yes	6	1/2"	1.06"/26.9MM	0.90"/22.7MM	0.76"/19.3MM	0.34"/8.6MM	1.3MM	
JHWISFXT418	3/8"	4.57"/116.1MM	Yes	6	9/16"	1.06"/26.9MM	0.90"/22.7MM	0.82"/20.8MM	0.44"/11.2MM	1.4MM	
JHWISFX418	3/8"	4.57"/116.1MM	No	6	9/16"	1.06"/26.9MM	0.90"/22.7MM	0.82"/20.8MM	0.44"/11.2MM	1.4MM	
JHWISFXT618	3/8"	6.57"/166.9MM	Yes	6	9/16"	1.06"/26.9MM	0.90"/22.7MM	0.82"/20.8MM	0.44"/11.2MM	1.4MM	
JHWISFX618	3/8"	6.57"/166.9MM	No	6	9/16"	1.06"/26.9MM	0.90"/22.7MM	0.82"/20.8MM	0.44"/11.2MM	1.4MM	
JHWISFXT420	3/8"	4.57"/116.1MM	Yes	6	5/8"	1.06"/26.9MM	0.90"/22.7MM	0.90"/22.7MM	0.44"/11.2MM	1.5MM	
JHWISFX420	3/8"	4.57"/116.1MM	No	6	5/8"	1.06"/26.9MM	0.90"/22.7MM	0.90"/22.7MM	0.44"/11.2MM	1.5MM	
JHWISFXT620	3/8"	6.57"/166.9MM	Yes	6	5/8"	1.06"/26.9MM	0.90"/22.7MM	0.90"/22.7MM	0.44"/11.2MM	1.5MM	
JHWISFX620	3/8"	6.57"/166.9MM	No	6	5/8"	1.06"/26.9MM	0.90"/22.7MM	0.90"/22.7MM	0.44"/11.2MM	1.5MM	



3/8" DRIVE SOCKET FLEXTENSIONS, METRIC

Black Industrial Finish

Product Code	Drive	A			Socket Points	Socket (mm)	B		C	D	E
		Shank Length	Tension	Socket Points			Socket Length	Socket Diameter	Nose Diameter	Socket Hex Depth	
JHWISFXTM410	3/8"	4.57"/116.1MM	Yes	6	10	1.06"/26.9MM	0.90"/22.7MM	0.63"/16.0MM	0.28"/7.1MM	1.1MM	
JHWISFXM410	3/8"	4.57"/116.1MM	No	6	10	1.06"/26.9MM	0.90"/22.7MM	0.63"/16.0MM	0.28"/7.1MM	1.1MM	
JHWISFXTM610	3/8"	6.57"/166.9MM	Yes	6	10	1.06"/26.9MM	0.90"/22.7MM	0.63"/16.0MM	0.28"/7.1MM	1.1MM	
JHWISFXM610	3/8"	6.57"/166.9MM	No	6	10	1.06"/26.9MM	0.90"/22.7MM	0.63"/16.0MM	0.28"/7.1MM	1.1MM	
JHWISFXTM412	3/8"	4.57"/116.1MM	Yes	6	12	1.06"/26.9MM	0.90"/22.7MM	0.76"/19.3MM	0.34"/8.6MM	1.2MM	
JHWISFXM412	3/8"	4.57"/116.1MM	No	6	12	1.06"/26.9MM	0.90"/22.7MM	0.76"/19.3MM	0.34"/8.6MM	1.2MM	
JHWISFXTM612	3/8"	6.57"/166.9MM	Yes	6	12	1.06"/26.9MM	0.90"/22.7MM	0.76"/19.3MM	0.34"/8.6MM	1.2MM	
JHWISFXM612	3/8"	6.57"/166.9MM	No	6	12	1.06"/26.9MM	0.90"/22.7MM	0.76"/19.3MM	0.34"/8.6MM	1.2MM	
JHWISFXTM413	3/8"	4.57"/116.1MM	Yes	6	13	1.06"/26.9MM	0.90"/22.7MM	0.76"/19.3MM	0.34"/8.6MM	1.3MM	
JHWISFXM413	3/8"	4.57"/116.1MM	No	6	13	1.06"/26.9MM	0.90"/22.7MM	0.76"/19.3MM	0.34"/8.6MM	1.3MM	
JHWISFXTM613	3/8"	6.57"/166.9MM	Yes	6	13	1.06"/26.9MM	0.90"/22.7MM	0.76"/19.3MM	0.34"/8.6MM	1.3MM	
JHWISFXM613	3/8"	6.57"/166.9MM	No	6	13	1.06"/26.9MM	0.90"/22.7MM	0.76"/19.3MM	0.34"/8.6MM	1.3MM	
JHWISFXTM415	3/8"	4.57"/116.1MM	Yes	6	15	1.06"/26.9MM	0.90"/22.7MM	0.88"/22.4MM	0.42"/10.7MM	1.4MM	
JHWISFXM415	3/8"	4.57"/116.1MM	No	6	15	1.06"/26.9MM	0.90"/22.7MM	0.88"/22.4MM	0.42"/10.7MM	1.4MM	
JHWISFXTM615	3/8"	6.57"/166.9MM	Yes	6	15	1.06"/26.9MM	0.90"/22.7MM	0.88"/22.4MM	0.42"/10.7MM	1.4MM	
JHWISFXM615	3/8"	6.57"/166.9MM	No	6	15	1.06"/26.9MM	0.90"/22.7MM	0.88"/22.4MM	0.42"/10.7MM	1.4MM	
JHWISFXTM416	3/8"	4.57"/116.1MM	Yes	6	16	1.06"/26.9MM	0.90"/22.7MM	0.90"/22.7MM	0.45"/11.4MM	1.5MM	
JHWISFXM416	3/8"	4.57"/116.1MM	No	6	16	1.06"/26.9MM	0.90"/22.7MM	0.90"/22.7MM	0.45"/11.4MM	1.5MM	
JHWISFXTM616	3/8"	6.57"/166.9MM	Yes	6	16	1.06"/26.9MM	0.90"/22.7MM	0.90"/22.7MM	0.45"/11.4MM	1.5MM	
JHWISFXM616	3/8"	6.57"/166.9MM	No	6	16	1.06"/26.9MM	0.90"/22.7MM	0.90"/22.7MM	0.45"/11.4MM	1.5MM	

Features

- Durable black oxide finish
- Socket retention pin is TIG welded, providing full rotation power to the socket
- Sockets feature SUPERTORQUE™ lobular openings for greater turning power without deforming the fastener
- Drive end has a 7/32" cross hole & bevel for ease of use
- Up to 30 degree angle offset
- Flexextensions are designed for use on hand and power tools (Impulse or Direct drive); NOT FOR IMPACT TOOL USE
- Maximum working torque values: 160 Ft. Lbs. /1920 In. Lbs. /217 Nm
- Other lengths and socket sizes available by special order. Contact your Snap-on Industrial Brands representative
- See pages 290 to 292 for 1/2" Drive Socket Flexextensions

SOCKETS AND DRIVE TOOLS





JHW2-140B

JHW2-4A



JHW2-106A



JHW2-103A



JHW2-02B



JHW2-33B



JHWWSB-6ADPA



JHWBHMD-30



JHWWSBHMD-7

3/8" DRIVE IMPACT EXTENSIONS AND ACCESSORIES

Black Industrial Finish

Product Code	Description	Length (Inches)	Socket Retention
JHW2-103A	Impact Extension	3	Spring Plunger
JHW2-106A	Impact Extension	6	Spring Plunger
JHW2-140B	Impact Universal Joint	2 1/4	Spring Plunger
JHW2-4A	1/2" M x 3/8" F Adapter	1 1/4	Spring Plunger

Fed. Spec: ANSI B107.2



Features

- Specially heat treated for impact use to provide long life, safety, and durability
- Spring plunger provides secure socket retention for safety and convenience
- Suitable for use with pneumatic and electric impact wrenches

3/8" DRIVE HEX TO SQUARE SHANK IMPACT EXTENSIONS

Black Industrial Finish

Product Code	Hex Shank Size (Inches)	Square Drive Size (Inches)	Length (Inches)
JHW2-02B	1/4	3/8	2
JHW2-33B	7/16	3/8	2 3/4



Features

- Specially heat treated for impact use to provide long life, safety, and durability
- Spring plunger provides secure socket retention for safety and convenience
- Suitable for use with pneumatic and electric impact wrenches
- 2-33B - Recommended working torque of 80 ft.lb

6 PIECE ADAPTOR SET

Black Finish and Impact, Furnished on Clip Rail

Product Code	Description
JHWWSB-6ADPA	6 Piece Adaptor Set

Contents Include:

Product Code	Description	Product Code	Description
JHWMB-130B	1/4" F x 3/8" M, Black Finish	JHW4-2F	1/2" F x 3/8" M, Impact, Black
JHWMB-131BA	3/8" F x 1/4" M, Black Finish	JHW4-6	1/2" F x 3/4" M, Impact, Black
JHWBS-130B	3/8" F x 1/2" M, Black Finish	JHW6-4A	3/4" F x 1/2" M, Impact, Black



Features

- Impact adaptors are suitable for use on electric and air impact wrenches
- Black finish adaptors are designed for use with hand drive tools

3/8" DRIVE HAND IMPACT DRIVER

Black Industrial Finish

Product Code	Length (Inches)	Shank Diameter (Inches)
JHWBHMD-30	5	1 1/4



Features

- Specially heat treated for impact use to provide long life, safety, and durability.
- Ball socket retention for fast socket changes.
- Ideal for loosening screws that cannot be loosened with an ordinary screwdriver.
- Impact driver is struck with a hammer to provide turning power.
- Hammer blow forces bit into screw head to reduce stripping.
- Hand impact driver can be used with all 3/8" drive sockets, such as 6-point and hex-bit sockets.

7 PIECE 3/8" DRIVE IMPACT DRIVER SET

Packed in Exclusive Keep-Safe-Foam System

Product Code	Description
JHWWSBHMD-7	7 Piece Impact Driver Set

Contents Include:

Product Code	Description	Product Code	Description
JHWBHMD-30	Hand Impact Driver	JHWBA-7A-2P	#2 Phillips® Bit Socket
JHWBA-7A-2S	7/32" x .040" Slotted Bit Socket	JHWBA-10A-3P	#3 Phillips® Bit Socket
JHWBA-10A-3S	9/32" x .045" Slotted Bit Socket	JHWBA-12A-4P	#4 Phillips® Bit Socket
JHWBA-10A-4S	5/16" x .055" Slotted Bit Socket		



3/8" DRIVE

SOCKETS AND
DRIVE TOOLS

3/8" DRIVE SHALLOW IMPACT SOCKETS, 6 POINT, SAE



Black Industrial Finish

Product Code	Size (Inches)	OAL (Inches)	Drive End Diameter (Inches)	Working End Diameter (Inches)	Broach Depth (Inches)	Bolt Clearance Depth (Inches)	Bolt Clearance Diameter (Inches)	Nose Length (Inches)
JHW2-608	1/4	1 1/32	1 1/16	1/2	7/32	9/16	7/32	17/32
JHW2-610	5/16	1 1/32	1 1/16	1/2	1/4	9/16	9/32	17/32
JHW2-612	3/8	1 1/32	1 1/16	5/8	9/32	9/16	11/32	17/32
JHW2-614	7/16	1 1/16	1 1/16	21/32	9/32	19/32	11/32	-
JHW2-616	1/2	1 1/16	3/4	3/4	5/16	19/32	3/8	-
JHW2-618	9/16	1 3/32	13/16	13/16	9/16	19/32	17/32	-
JHW2-620	5/8	1 1/8	29/32	29/32	19/32	5/8	5/8	-
JHW2-622	11/16	1 9/32	31/32	31/32	19/32	5/8	21/32	-
JHW2-624	3/4	1 3/16	1 1/16	1 1/16	21/32	11/16	23/32	-
JHW2-626	13/16	1 1/4	1 1/8	1 1/8	11/16	23/32	25/32	-
JHW2-628	7/8	1 9/32	1 3/16	1 3/16	3/4	3/4	27/32	-
JHW2-630	15/16	1 5/16	1 9/32	1 9/32	25/32	13/16	29/32	-
JHW2-632	1	1 1/16	1 1/32	1 1/32	25/32	25/32	31/32	-

Fed. Spec: ANSI B107.2

Drop Prevention System

Side hole in socket permits use with Snap-on Industrial Brands Tools@Height drive tools such as ratchets, extensions and u-joints



JHW2-618 JHW2-608

JHWWS-2-8 8 Piece 3/8" Drive Shallow 6 Point Impact Socket Set on Clip Rail

Product Code	Size (Inches)	Product Code	Size (Inches)
JHW2-610	5/16	JHW2-618	9/16
JHW2-612	3/8	JHW2-620	5/8
JHW2-614	7/16	JHW2-622	11/16
JHW2-616	1/2	JHW2-624	3/4



JHWWS-2-8

JHWWS-2-13 13 Piece 3/8" Drive Shallow 6 Point Impact Socket Set on Clip Rail

Product Code	Size (Inches)	Product Code	Size (Inches)
JHW2-608	1/4	JHW2-618	9/16
JHW2-610	5/16	JHW2-620	5/8
JHW2-612	3/8	JHW2-622	11/16
JHW2-614	7/16	JHW2-624	3/4
JHW2-616	1/2	JHW2-626	13/16



JHWWS-2-13

Features

- SUPERTORQUE™ lobular openings for greater turning power without deforming the fastener
- Designed for maximum engagement on 6 point fasteners
- Suitable for use with pneumatic and electric impact wrenches
- Specially heat treated for impact use to provide long life, safety, and durability



Made in U.S.A.

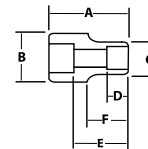

3/8" DRIVE UNIVERSAL IMPACT SOCKETS, 6 POINT, SAE



Black Industrial Finish

Product Code	Size (Inches)	OAL (Inches)	Drive End Diameter (Inches)	Working End Diameter (Inches)	Broach Depth (Inches)	Bolt Clearance Depth (Inches)	Bolt Clearance Diameter (Inches)	Nose Length (Inches)
JHW36212	3/8	2 1/4	1	19/16	9/16	9/16	3/16	15/16
JHW36214	7/16	2 1/4	1	1 1/16	9/16	9/16	3/16	15/16
JHW36216	1/2	2 1/8	1	1 3/16	9/16	9/16	7/16	1 1/16
JHW36218	9/16	2 1/8	1	1 3/16	9/16	9/16	9/16	1 1/16
JHW36220	5/8	2 1/8	1	1 3/16	9/16	9/16	9/16	1 1/16
JHW36222	11/16	2 5/8	1	1	9/16	1 1/16	10/16	1 3/16
JHW36224	3/4	2 3/8	1	1 3/16	9/16	1 1/16	1 1/16	1 3/16

Fed. Spec: ANSI B107.2

JHW36912 7 Piece 3/8" Drive Universal 6 Point Impact Socket Set on Clip Rail

Product Code	Size (Inches)	Product Code	Size (Inches)
JHW36212	3/8	JHW36220	5/8
JHW36214	7/16	JHW36222	11/16
JHW36216	1/2	JHW36224	3/4
JHW36218	9/16		



JHW36224



JHW36912

Features

- SUPERTORQUE™ lobular openings for greater turning power without deforming the fastener
- Designed for maximum engagement on 6 point fasteners
- Suitable for use with pneumatic and electric impact wrenches
- Specially heat treated for impact use to provide long life, safety, and durability
- Drive end features pin retention hole and groove



TOOLS @ HEIGHT
DROP PREVENTION SYSTEM

Side hole in socket permits use with Snap-on Industrial Brands Tools@Height drive tools such as ratchets, extensions and u-joints

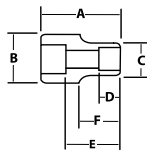

3/8" DRIVE SHALLOW IMPACT SOCKETS, 12 POINT, SAE



Black Industrial Finish

Product Code	Size (Inches)	A OAL (Inches)	B Drive End Diameter (Inches)	C Working End Diameter (Inches)	D Broach Depth (Inches)	E Bolt Clearance Depth (Inches)	F Bolt Clearance Diameter (Inches)	Nose Length (Inches)
JHW35310	5/16	1 1/8	3/4	1/2	3/8	/	1/4	1/2
JHW35312	3/8	1 1/8	3/4	1/2	3/8	/	3/8	1/2
JHW35314	7/16	1 1/8	3/4	5/8	3/8	/	3/8	1/2
JHW35316	1/2	1 1/8	3/4	3/4	3/8	/	3/8	/
JHW35318	9/16	1 1/8	3/4	3/4	3/8	/	1/2	/
JHW35320	5/8	1 1/8	1	15/16	1/2	/	1/2	/
JHW35322	11/16	1 1/8	1	15/16	1/2	/	1/2	/
JHW35324	3/4	1 1/8	1	1	1/2	/	5/8	/
JHW35326	13/16	1 1/8	1 1/8	1	1/2	/	3/4	/
JHW35328	7/8	1 1/8	1 1/8	1 1/8	1/2	/	3/4	/
JHW35330	15/16	1 1/8	1 1/4	1 1/4	1/2	/	3/4	/
JHW35332	1	1 1/8	1 3/8	1 3/8	1/2	/	1	/

JHW36921 12 piece 3/8" Drive Shallow 12 Point Impact Socket Set on Clip Rail

Contents Include:

Product Code	Size (Inches)	Product Code	Size (Inches)	Product Code	Size (Inches)
JHW35310	5/16	JHW35318	9/16	JHW35326	13/16
JHW35312	3/8	JHW35320	5/8	JHW35328	7/8
JHW35314	7/16	JHW35322	11/16	JHW35330	15/16
JHW35316	1/2	JHW35324	3/4	JHW35332	1

Features

- SUPERTORQUE™ lobular openings for greater turning power without deforming the fastener
- Designed for maximum engagement on 6 or 12 point fasteners
- Suitable for use with pneumatic and electric impact wrenches
- Specially heat treated for impact use to provide long life, safety, and durability
- Drive end features pin retention hole and groove

3/8" DRIVE DEEP IMPACT SOCKETS, 6 POINT, SAE



Black Industrial Finish

Product Code	Size (Inches)	A OAL (Inches)	B Drive End Diameter (Inches)	C Working End Diameter (Inches)	D Broach Depth (Inches)	E Bolt Clearance Depth (Inches)	F Bolt Clearance Diameter (Inches)	Nose Length (Inches)
JHW12-610	5/16	2 1/8	11/16	1/2	1/4	1 21/32	9/32	1 5/8
JHW12-612	3/8	2 1/8	11/16	5/8	9/32	1 1/2	11/32	1 5/8
JHW12-614	7/16	2 1/8	11/16	21/32	11/32	1 5/8	11/32	1 5/8
JHW12-616	1/2	2 1/8	3/4	3/4	3/8	1 15/32	7/16	-
JHW12-618	9/16	2 3/8	13/16	13/16	7/16	1 1/2	17/32	-
JHW12-620	5/8	2 3/8	29/32	29/32	15/32	1 1/2	5/8	-
JHW12-622	11/16	2 3/8	31/32	31/32	1/2	1 19/32	21/32	-
JHW12-624	3/4	2 3/8	1 1/16	1 1/16	9/16	1 19/32	23/32	-
JHW12-626	13/16	2 3/4	1 1/8	1 1/8	9/16	1 25/32	25/32	-
JHW12-628	7/8	2 3/4	1 3/16	1 3/16	19/32	1 7/8	27/32	-
JHW12-630	15/16	2 3/4	1 9/32	1 9/32	19/32	1 15/16	29/32	-
JHW12-632	1	2 3/4	1 11/32	1 11/32	5/8	2	1	-

Fed. Spec: ANSI B107.2

JHWWS-12-8 8 Piece 3/8" Drive Deep 6 Point Impact Socket Set on Clip Rail

Contents Include:

Product Code	Size (Inches)	Product Code	Size (Inches)	Product Code	Size (Inches)	Product Code	Size (Inches)
JHW12-610	5/16	JHW12-614	7/16	JHW12-618	9/16	JHW12-622	11/16
JHW12-612	3/8	JHW12-616	1/2	JHW12-620	5/8	JHW12-624	3/4

JHWWS-12-12 12 Piece 3/8" Drive Deep 6 Point Impact Socket Set on Clip Rail

Contents Include:

Product Code	Size (Inches)	Product Code	Size (Inches)	Product Code	Size (Inches)	Product Code	Size (Inches)
JHW12-610	5/16	JHW12-616	1/2	JHW12-622	11/16	JHW12-628	7/8
JHW12-612	3/8	JHW12-618	9/16	JHW12-624	3/4	JHW12-630	15/16
JHW12-614	7/16	JHW12-620	5/8	JHW12-626	13/16	JHW12-632	1

Features

- SUPERTORQUE™ lobular openings for greater turning power without deforming the fastener
- Designed for maximum engagement on 6 point fasteners
- Suitable for use with pneumatic and electric impact wrenches
- Specially heat treated for impact use to provide long life, safety, and durability

3/8" DRIVE SOCKETS AND DRIVE TOOLS

3/8" DRIVE DEEP IMPACT SOCKETS, 12 POINT, SAE



Black Industrial Finish

Product Code	Size (Inches)	A OAL (Inches)	B Drive End Diameter (Inches)	C Working End Diameter (Inches)	D Broach Depth (Inches)	E Bolt Clearance Depth (Inches)	F Bolt Clearance Diameter (Inches)	F Nose Length (Inches)
JHW36410	5/16	2 1/2	3/4	1/2	1/2	/	3/8	1 1/4
JHW36412	3/8	2 1/2	3/4	1/2	3/4	/	1/2	1 1/4
JHW36414	7/16	2 1/2	3/4	5/8	3/4	/	1/2	1 1/4
JHW36416	1/2	2 1/2	3/4	3/4	1	/	1/2	/
JHW36418	9/16	2 1/2	3/4	3/4	1	/	1/2	/
JHW36420	5/8	2 1/2	1	1	1	/	1/2	/
JHW36422	11/16	2 1/2	1	1	1	/	1/2	/
JHW36424	3/4	2 1/2	1	1	1	/	3/4	/
JHW36426	13/16	2 1/2	1	1	1	/	3/4	/
JHW36428	7/8	2 1/2	1 1/8	1 1/8	1	/	3/4	/
JHW36430	15/16	2 1/2	1 1/4	1 1/4	1	/	5/8	/
JHW36432	1	2 1/2	1 3/8	1 3/8	1	/	1	/



JHW36416 JHW36410

Side hole in socket permits use with Snap-on Industrial Brands Tools@Height drive tools such as ratchets, extensions and u-joints

JHW36922 12 piece 3/8" Drive Shallow 12 Point Impact Socket Set on Clip Rail Contents Include:

Product Code	Size (Inches)	Product Code	Size (Inches)	Product Code	Size (Inches)
JHW36410	5/16	JHW36418	9/16	JHW36426	13/16
JHW36412	3/8	JHW36420	5/8	JHW36428	7/8
JHW36414	7/16	JHW36422	11/16	JHW36430	15/16
JHW36416	1/2	JHW36424	3/4	JHW36432	1



JHW36922

Features

- SUPERTORQUE™ lobular openings for greater turning power without deforming the fastener
- Designed for maximum engagement on 6 or 12 point fasteners
- Suitable for use with pneumatic and electric impact wrenches
- Specially heat treated for impact use to provide long life, safety, and durability
- Drive end features pin retention hole and groove

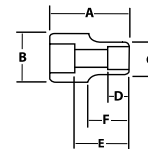

3/8" DRIVE SHALLOW IMPACT SOCKETS, 6 POINT, METRIC



Black Industrial Finish

Product Code	Size (MM)	A OAL (Inches)	B Drive End Diameter (Inches)	C Working End Diameter (Inches)	D Broach Depth (Inches)	E Bolt Clearance Depth (Inches)	F Bolt Clearance Diameter (Inches)	F Nose Length (Inches)
JHW2M-607	7	1 1/32	11/16	7/16	7/32	9/16	1/4	17/32
JHW2M-608	8	1 1/32	11/16	1/2	1/4	9/16	9/32	17/32
JHW2M-609	9	1 1/32	11/16	9/16	9/32	9/16	11/32	17/32
JHW2M-610	10	1 1/32	11/16	5/8	9/32	9/16	11/32	17/32
JHW2M-611	11	1 1/32	11/16	21/32	9/32	19/32	11/32	9/16
JHW2M-612	12	1 1/16	23/32	23/32	9/32	9/16	11/32	-
JHW2M-613	13	1 1/16	25/32	25/32	9/32	19/32	5/8	-
JHW2M-614	14	1 3/32	13/16	13/16	9/16	19/32	1/2	-
JHW2M-615	15	1 3/32	27/32	27/32	9/16	19/32	9/16	-
JHW2M-616	16	1 1/8	29/32	29/32	19/32	19/32	9/16	-
JHW2M-617	17	1 5/32	31/32	31/32	19/32	5/8	5/8	-
JHW2M-618	18	1 3/32	1	1	5/8	21/32	11/16	-
JHW2M-619	19	1 3/16	1 1/16	1 1/16	21/32	11/16	23/32	-



JHW2M-614 JHW2M-607

JHWMS-2-13H 13 Piece 3/8" Drive Shallow 6 Point Impact Socket Set on Clip Rail Contents Include:

Product Code	Size (MM)	Product Code	Size (MM)	Product Code	Size (MM)
JHW2M-607	7	JHW2M-612	12	JHW2M-617	17
JHW2M-608	8	JHW2M-613	13	JHW2M-618	18
JHW2M-609	9	JHW2M-614	14	JHW2M-619	19
JHW2M-610	10	JHW2M-615	15		
JHW2M-611	11	JHW2M-616	16		



JHWMS-2-13H

Features

- SUPERTORQUE™ lobular openings for greater turning power without deforming the fastener
- Designed for maximum engagement on 6 point fasteners
- Suitable for use with pneumatic and electric impact wrenches
- Specially heat treated for impact use to provide long life, safety, and durability



TOOLS @ HEIGHT
DROP PREVENTION SYSTEM

Side hole in socket permits use with Snap-on Industrial Brands Tools@Height drive tools such as ratchets, extensions and u-joints

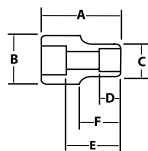

3/8" DRIVE SHALLOW IMPACT SOCKETS, 12 POINT, METRIC



Black Industrial Finish

Product Code	Size (MM)	A	B	C	D	E	F	
		Overall Length (Inches)	Drive End Diameter (Inches)	Working End Diameter (Inches)	Broach Depth (Inches)	Bolt Clearance Depth (Inches)	Bolt Clearance Diameter (Inches)	Nose Length (Inches)
JHW36607	7	1 1/8	3/4	1/2	3/8	/	3/8	1/2
JHW36608	8	1 1/8	3/4	1/2	3/8	/	1/2	1/2
JHW36609	9	1 1/8	3/4	1/2	3/8	/	1/2	1/2
JHW36610	10	1 1/8	3/4	1/2	3/8	/	1/2	1/2
JHW36611	11	1 1/8	3/4	1/2	1/2	/	1/2	1/2
JHW36612	12	1 1/8	3/4	3/4	1/2	/	1/2	/
JHW36613	13	1 1/8	3/4	3/4	1/2	/	1/2	/
JHW36614	14	1 1/8	3/4	3/4	1/2	/	1/2	/
JHW36615	15	1 1/8	7/8	7/8	1/2	/	1/2	/
JHW36616	16	1 1/8	7/8	1	1/2	/	1/2	/
JHW36617	17	1 1/8	7/8	1	1/2	/	3/8	/
JHW36618	18	1 1/8	1	1	1/2	/	3/8	/
JHW36619	19	1 1/8	1	1	1/2	/	3/8	/

JHW36923 13 Piece 3/8" Drive Shallow 12 point Impact Socket Set on Clip and Rail Contents Include:

Product Code	Size (MM)	Product Code	Size (MM)	Product Code	Size (MM)
JHW36607	7	JHW36612	12	JHW36617	17
JHW36608	8	JHW36613	13	JHW36618	18
JHW36609	9	JHW36614	14	JHW36619	19
JHW36610	10	JHW36615	15		
JHW36611	11	JHW36616	16		

Features

- SUPERTORQUE™ lobular openings for greater turning power without deforming the fastener
- Designed for maximum engagement on 6 or 12 point fasteners
- Suitable for use with pneumatic and electric impact wrenches
- Specially heat treated for impact use to provide long life, safety, and durability
- Drive end features pin retention hole and groove

3/8" DRIVE UNIVERSAL IMPACT SOCKETS, 6 POINT, METRIC



Black Industrial Finish

Product Code	Size (MM)	A	B	C	D	E	F	
		OAL (Inches)	Drive End Diameter (Inches)	Working End Diameter (Inches)	Broach Depth (Inches)	Bolt Clearance Depth (Inches)	Bolt Clearance Diameter (Inches)	Nose Length (Inches)
JHW36810	10	2 1/4	7/8	5/8	3/8	1/2	3/16	15/16
JHW36811	11	2 1/4	7/8	11/16	1/2	1/2	3/8	15/16
JHW36812	12	2 1/4	7/8	11/16	1/2	1/2	3/8	15/16
JHW36813	13	3/8	7/8	13/16	1/2	9/16	3/8	1 1/16
JHW36814	14	3/8	7/8	13/16	1/2	9/16	1/2	1 1/16
JHW36815	15	3/8	7/8	7/8	1/2	9/16	9/16	1 1/16
JHW36816	16	3/8	7/8	7/8	1/2	9/16	9/16	1 1/16
JHW36817	17	3/8	7/8	1	1/2	11/16	5/8	1 1/4
JHW36818	18	2 5/8	7/8	1 1/16	1/2	11/16	11/16	1 1/4
JHW36819	19	2 5/8	7/8	1/8	1/2	11/16	11/16	1 1/4

JHW36910 10 Piece 3/8" Drive Universal 6 Point Impact Socket Set on Clip Rail Contents Include:

Product Code	Size (MM)	Product Code	Size (MM)	Product Code	Size (MM)
JHW36810	10	JHW36814	14	JHW36818	18
JHW36811	11	JHW36815	15	JHW36819	19
JHW36812	12	JHW36816	16		
JHW36813	13	JHW36817	17		

Features

- SUPERTORQUE™ lobular openings for greater turning power without deforming the fastener
- Designed for maximum engagement on 6 point fasteners
- Suitable for use with pneumatic and electric impact wrenches
- Specially heat treated for impact use to provide long life, safety, and durability
- Drive end features pin retention hole and groove

3/8" DRIVE

SOCKETS AND
DRIVE TOOLS

3/8" DRIVE DEEP IMPACT SOCKETS, 6 POINT, METRIC



Black Industrial Finish

Product Code	A	B	C	D	E	F	
Size (MM)	OAL (Inches)	Drive End Diameter (Inches)	Working End Diameter (Inches)	Broach Depth (Inches)	Bolt Clearance Depth (Inches)	Bolt Clearance Diameter (Inches)	Nose Length (Inches)
JHW12M-607	7	2 1/8	1 1/16	7/16	9/32	1 11/16	1 5/8
JHW12M-608	8	2 1/8	1 1/16	1/2	1/4	1 11/16	1 5/8
JHW12M-609	9	2 1/8	1 1/16	9/16	9/32	1 11/16	1 5/8
JHW12M-610	10	2 1/8	1 1/16	5/8	9/32	1 11/16	1 5/8
JHW12M-611	11	2 1/8	1 1/16	2 1/32	2 1/64	1 11/16	1 5/8
JHW12M-612	12	2 1/8	2 3/32	2 3/32	3/8	1 23/32	-
JHW12M-613	13	2 1/8	2 9/32	2 9/32	7/16	1 3/8	1 5/8
JHW12M-614	14	2 3/8	1 9/16	1 9/16	1 3/32	1/2	-
JHW12M-615	15	2 3/8	2 3/32	2 3/32	1 3/32	9/16	-
JHW12M-616	16	2 3/8	2 9/32	2 9/32	1 3/32	1 9/16	1 5/8
JHW12M-617	17	2 5/8	3 1/32	3 1/32	7/16	1 3/4	5/8
JHW12M-618	18	2 5/8	1	1	7/16	1 3/4	1 1/16
JHW12M-619	19	2 5/8	1 1/16	1 1/16	9/16	1 3/4	2 3/32
JHW12M-620	20	2 5/8	1 1/8	1 1/8	1 5/32	1 3/4	3/4
JHW12M-621	21	2 5/8	1 5/32	1 5/32	1/2	1 3/4	2 5/32
JHW12M-622	22	2 7/8	1 3/16	1 3/16	1/2	1 31/32	2 1/32
JHW12M-623	23	2 7/8	1 1/4	1 1/4	1 17/32	1 31/32	7/8
JHW12M-624	24	2 7/8	1 5/16	1 5/16	1 19/32	1 31/32	2 9/32

Side hole in socket permits use with Snap-on Industrial Brands Tools@Height drive tools such as ratchets, extensions and u-joints

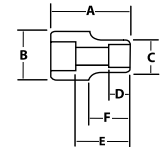

JHWMS-12-13H 13 Piece 3/8" Drive Deep 6 Point Impact Socket Set on Clip Rail

Contents Include:

Product Code	Size (MM)	Product Code	Size (MM)	Product Code	Size (MM)
JHW12M-607	7	JHW12M-612	12	JHW12M-617	17
JHW12M-608	8	JHW12M-613	13	JHW12M-618	18
JHW12M-609	9	JHW12M-614	14	JHW12M-619	19
JHW12M-610	10	JHW12M-615	15		
JHW12M-611	11	JHW12M-616	16		



JHWMS-12-13H

JHWMS-12-18H 18 Piece 3/8" Drive Deep 6 Point Impact Socket Set on Clip Rail

Contents Include:

Product Code	Size (MM)	Product Code	Size (MM)	Product Code	Size (MM)
JHW12M-607	7	JHW12M-613	13	JHW12M-619	19
JHW12M-608	8	JHW12M-614	14	JHW12M-620	20
JHW12M-609	9	JHW12M-615	15	JHW12M-621	21
JHW12M-610	10	JHW12M-616	16	JHW12M-622	22
JHW12M-611	11	JHW12M-617	17	JHW12M-623	23
JHW12M-612	12	JHW12M-618	18	JHW12M-624	24



JHWMS-12-18H

Features

- SUPERTORQUE™ lobular openings for greater turning power without deforming the fastener
- Designed for maximum engagement on 6 point fasteners
- Suitable for use with pneumatic and electric impact wrenches
- Specially heat treated for impact use to provide long life, safety, and durability



3/8" DRIVE HEX DRIVERS



Product Code	Size	Overall Length (Inches)	Product Code Bits	Optional Ret Ring
JHW2MA-612	12 mm	72.7 mm	JHW2MA-612-2	2-1XS
JHW2MA-614	14 mm	72.7 mm	JHW2MA-614-2	2-1XS
JHW2A-616	1/2"	2 7/8"	JHW2A-616-2	2-1XS
JHW2A-618	9/16"	2 7/8"	JHW2A-618-2	2-1XS

Features

- Designed for use with pneumatic or cordless impact guns
- Optional retaining ring ensures positive attachment to anvil
- Manufactured from special alloy steel and heat treated for optimum strength and durability
- Williams® bits are designed with a precise fit and tight tolerances to prevent slippage and disengagement
- Outperforms one-piece design models – our two-piece design makes replacement economical and convenient
- Bits can be easily replaced by hand - no need to put them in a vice and punch them out with a hammer
- Optional retaining rings available for added protection



JHW2MA-614



JHW2MA-614 with Optional Ret Ring 2-1XS



3/8" DRIVE

SOCKETS AND DRIVE TOOLS



TOOLS @ HEIGHT
DROP PREVENTION SYSTEM

Side hole in socket permits use with Snap-on Industrial Brands Tools@Height drive tools such as ratchets, extensions and u-joints



JHW35412 JHW35407

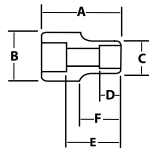

3/8" DRIVE DEEP IMPACT SOCKETS, 12 POINT, METRIC



Black Industrial Finish

Product Code	Size (mm)	A	B	C	D	E	Bolt Clearance Diameter (Inches)	Nose Length (Inches)
		Overall Length (Inches)	Drive End Diameter (Inches)	Working End Diameter (Inches)	Broach Depth (Inches)	Bolt Clearance Depth (Inches)		
JHW35407	7	2 1/2	3/4	1/2	1/2	/	1/4	1 1/4
JHW35408	8	2 1/2	3/4	1/2	1/2	/	1/4	1 1/4
JHW35409	9	2 1/2	3/4	1/2	1/2	/	1/4	1 1/4
JHW35410	10	2 1/2	3/4	1/2	3/4	/	3/8	1 1/4
JHW35411	11	2 1/2	3/4	1/2	3/4	/	3/8	1 1/4
JHW35412	12	2 1/2	3/4	3/4	3/4	/	3/8	/
JHW35413	13	2 1/2	3/4	3/4	7/8	/	1/2	/
JHW35414	14	2 1/2	3/4	3/4	7/8	/	1/2	/
JHW35415	15	2 1/2	7/8	7/8	1	/	1/2	/
JHW35416	16	2 1/2	7/8	7/8	1	/	1/2	/
JHW35417	17	2 1/2	7/8	7/8	1	/	1/2	/
JHW35418	18	2 1/2	7/8	7/8	1	/	5/8	/
JHW35419	19	2 1/2	1	1	1	/	5/8	/

JHW36924 13 Piece 3/8" Drive Deep 12 point Impact Socket Set on Clip and Rail

Contents Include:

Product Code	Size (MM)	Product Code	Size (MM)	Product Code	Size (MM)
JHW35407	7	JHW35411	11	JHW35415	15
JHW35408	8	JHW35412	12	JHW35416	16
JHW35409	9	JHW35413	13	JHW35417	17
JHW35410	10	JHW35414	14	JHW35418	18
				JHW35419	19

Features

- SUPERTORQUE™ lobular openings for greater turning power without deforming the fastener
- Designed for maximum engagement on 6 or 12 point fasteners
- Suitable for use with pneumatic and electric impact wrenches
- Specially heat treated for impact use to provide long life, safety, and durability
- Drive end features pin retention hole and groove



JHW36924

3/8" DRIVE

SOCKETS AND DRIVE TOOLS

57 PIECE 1/2" DRIVE SOCKET AND DRIVE TOOL SET



8 & 12 Point SAE, with Metal Box

Product Code	Description
JHWWSS-57TB	57 Piece Tool Set with JHWTB-6124B Metal Tool Box
JHWWSS-57F	57 Piece Tool Set Only

Contents Include:

Drive Tools:		Drive Tools:	
Product Code	Description	Product Code	Description
JHWS-15A	18" Speeder Handle	JHWS-70	Ratchet Spinner Disk
JHWS-20A	12" Sliding T-Handle	JHWS-102P	2" Extension
JHWS-40AA	10 13/16" Flex Handle	JHWS-110P	5" Extension
JHWS-41AA	15 1/2" Flex Handle	JHWS-115P	10" Extension
JHWS-52EHA	10 3/8" Enclosed Head Ratchet	JHWS-140A	Universal Joint
JHWS-52EHLA	15" Enclosed Head Ratchet		

Shallow 12-Point Sockets

Product Code	Size (Inches)
JHWS-1212	3/8
JHWS-1214	7/16
JHWS-1216	1/2
JHWS-1218	9/16
JHWS-1220	5/8
JHWS-1222	11/16
JHWS-1224	3/4
JHWS-1226	13/16
JHWS-1228	7/8
JHWS-1230	15/16
JHWS-1232	1
JHWS-1234	1 1/16
JHWS-1236	1 1/8
JHWS-1238	1 3/16
JHWS-1240	1 1/4
JHWS-1242	1 5/16
JHWS-1244	1 3/8
JHWS-1246	1 7/16
JHWS-1248	1 1/2

Standard Hex Bit Sockets

Product Code	Size (Inches)
JHWSA-8A	1/4
JHWSA-10A	5/16
JHWSA-12A	3/8
JHWSA-16A	1/2
JHWSA-18A	9/16
JHWSA-20A	5/8

Deep 12-Point Sockets

Product Code	Size (Inches)
JHWS-1216	1/2
JHWS-1218	9/16
JHWS-1220	5/8
JHWS-1222	11/16
JHWS-1224	3/4
JHWS-1226	13/16
JHWS-1228	7/8
JHWS-1230	15/16
JHWS-1232	1
JHWS-1234	1 1/16
JHWS-1236	1 1/8

Shallow 8-Point Sockets

Product Code	Size (Inches)
JHWS-812	3/8
JHWS-814	7/16
JHWS-816	1/2
JHWS-818	9/16
JHWS-820	5/8
JHWS-822	11/16
JHWS-824	3/4
JHWS-826	13/16
JHWS-828	7/8
JHWS-832	1



JHWWSS-57TB

Features

- All tools are professional quality, made of high-grade chrome vanadium steel
- Sockets feature SUPERTORQUE™ lobular openings for greater turning power without deforming the fastener
- Metal tool box made for years of rugged use



1/2" DRIVE

SOCKETS AND DRIVE TOOLS



38 PIECE 1/2" DRIVE SOCKET AND DRIVE TOOL SET

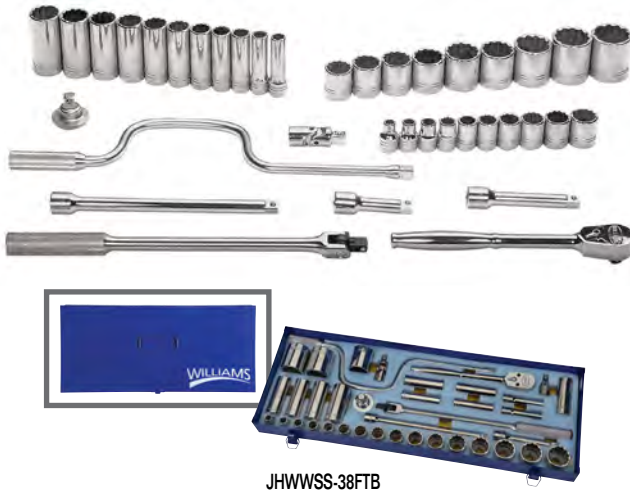

JHWWSS-38FTB

Features

- All tools are professional quality, made of high-grade chrome vanadium steel
- Sockets feature SUPERTORQUE™ lobular openings for greater turning power without deforming the fastener
- Metal tool box made for years of rugged use

12 Point SAE, with Metal Box

Product Code	Description
JHWWSS-38FTB	38 Piece Tool Set with JHWTB-104 Metal Tool Box
JHWWSS-38F	38 Piece Tool Set Only - Packed in Keep Safe Foam System

Contents Include:

Drive Tools:		Drive Tools:	
Product Code	Description	Product Code	Description
JHWS-15A	18" Speeder Handle	JHWS-140A	Universal Joint
JHWS-41AA	15 1/2" Flex Handle	JHWS-102P	2" Extension
JHWS-52EHA	10 3/8" Enclosed Head Ratchet	JHWS-110P	5" Extension
JHWS-70	Ratchet Spinner Disk	JHWS-115P	10" Extension

Shallow 12-Point Sockets

Product Code	Size (Inches)
JHWST-1212	3/8
JHWST-1214	7/16
JHWST-1216	1/2
JHWST-1218	9/16
JHWST-1220	5/8
JHWST-1222	11/16
JHWST-1224	3/4
JHWST-1226	13/16
JHWST-1228	7/8
JHWST-1230	15/16
JHWST-1232	1
JHWST-1234	1 1/16
JHWST-1236	1 1/8
JHWST-1238	1 3/16
JHWST-1240	1 1/4
JHWST-1242	1 5/16

Shallow 12-Point Sockets

Product Code	Size (Inches)
JHWSD-1244	1 3/8
JHWSD-1246	1 7/16
JHWSD-1248	1 1/2

Deep 12-Point Sockets

Product Code	Size (Inches)
JHWSD-1216	1/2
JHWSD-1218	9/16
JHWSD-1220	5/8
JHWSD-1222	11/16
JHWSD-1224	3/4
JHWSD-1226	13/16
JHWSD-1228	7/8
JHWSD-1230	15/16
JHWSD-1232	1
JHWSD-1234	1 1/16
JHWSD-1236	1 1/8



30 PIECE 1/2" DRIVE SOCKET AND DRIVE TOOL SET



JHWWSS-30FTB

Features

- Keep-Safe-Foam system keeps tools organized and helps prevent loss
- All tools are professional quality, made of high-grade chrome vanadium steel
- Sockets feature SUPERTORQUE™ lobular openings for greater turning power without deforming the fastener
- Metal tool box made for years of rugged use

12 Point SAE, with Metal Box

Product Code	Description
JHWWSS-30FTB	30 Piece Tool Set with JHWTB-104 Metal Tool Box
JHWWSS-30F	30 Piece Tool Set Only - Packed in Keep Safe Foam System

Contents Include:

Drive Tools:		Drive Tools:	
Product Code	Description	Product Code	Description
JHWS-41AA	15 1/2" Flex Handle	JHWS-110P	5" Extension
JHWS-52EHA	10 3/8" Enclosed Head Ratchet	JHWS-115P	10" Extension
JHWS-140A	Universal Joint		

Shallow 12-Point Sockets

Product Code	Size (Inches)
JHWST-1212	3/8
JHWST-1214	7/16
JHWST-1216	1/2
JHWST-1218	9/16
JHWST-1220	5/8
JHWST-1222	11/16
JHWST-1224	3/4
JHWST-1226	13/16
JHWST-1228	7/8
JHWST-1230	15/16
JHWST-1232	1
JHWST-1234	1 1/16
JHWST-1236	1 1/8
JHWST-1240	1 1/4

Deep 12-Point Sockets

Product Code	Size (Inches)
JHWSD-1216	1/2
JHWSD-1218	9/16
JHWSD-1220	5/8
JHWSD-1222	11/16
JHWSD-1224	3/4
JHWSD-1226	13/16
JHWSD-1228	7/8
JHWSD-1230	15/16
JHWSD-1232	1
JHWSD-1234	1 1/16
JHWSD-1236	1 1/8



1/2" DRIVE

SOCKETS AND DRIVE TOOLS

22 PIECE 1/2" DRIVE SOCKET AND DRIVE TOOL SET



12 Point SAE, Packed in Exclusive Keep-Safe-Foam System with Metal Box

Product Code	Description
JHWSS-22FTB	22 Piece Tool Set with JHWTB-104 Metal Tool Box
JHWSS-22F	22 Piece Tool Set Only - Packed in Keep Safe Foam System

Contents Include:

Drive Tools:		Drive Tools:	
Product Code	Description	Product Code	Description
JHWS-15A	18" Speeder Handle	JHWS-102P	2" Extension
JHWS-41AA	15 1/2" Flex Handle	JHWS-110P	5" Extension
JHWS-52EHA	10 3/8" Enclosed Head Ratchet	JHWS-115P	10" Extension
JHWS-140A	Universal Joint		

Shallow 12-Point Sockets		Shallow 12-Point Sockets	
Product Code	Size (Inches)	Product Code	Size (Inches)
JHWST-1212	3/8	JHWST-1228	7/8
JHWST-1214	7/16	JHWST-1230	15/16
JHWST-1216	1/2	JHWST-1232	1
JHWST-1218	9/16	JHWST-1234	1 1/16
JHWST-1220	5/8	JHWST-1236	1 1/8
JHWST-1222	11/16	JHWST-1238	1 3/16
JHWST-1224	3/4	JHWST-1240	1 1/4
JHWST-1226	13/16		

Features

- Keep-Safe-Foam system keeps tools organized and helps prevent loss
- All tools are professional quality, made of high-grade chrome vanadium steel
- Sockets feature SUPERTORQUE™ lobular openings for greater turning power without deforming the fastener
- Metal tool box made for years of rugged use



JHWSS-22FTB

19 PIECE 1/2" DRIVE SOCKET AND DRIVE TOOL SET



12 Point SAE, Packed in Exclusive Keep-Safe-Foam System with Metal Box

Product Code	Description
JHWSS-19FTB	19 Piece Tool Set with JHWTB103 Metal Tool Box
JHWSS-19F	19 Piece Tool Set Only - Packed in Keep Safe Foam System

Contents Include:

Drive Tools:		Drive Tools:	
Product Code	Description	Product Code	Description
JHWS-41AA	15 1/2" Flex Handle	JHWS-110P	5" Extension
JHWS-52EHA	10 3/8" Enclosed Head Ratchet	JHWS-140A	Universal Joint

Shallow 12-Point Sockets		Shallow 12-Point Sockets	
Product Code	Size (Inches)	Product Code	Size (Inches)
JHWST-1212	3/8	JHWST-1228	7/8
JHWST-1214	7/16	JHWST-1230	15/16
JHWST-1216	1/2	JHWST-1232	1
JHWST-1218	9/16	JHWST-1234	1 1/16
JHWST-1220	5/8	JHWST-1236	1 1/8
JHWST-1222	11/16	JHWST-1238	1 3/16
JHWST-1224	3/4	JHWST-1240	1 1/4
JHWST-1226	13/16		

Features

- Keep-Safe-Foam system keeps tools organized and helps prevent loss
- All tools are professional quality, made of high-grade chrome vanadium steel
- Sockets feature SUPERTORQUE™ lobular openings for greater turning power without deforming the fastener
- Metal tool box made for years of rugged use



JHWSS-19FTB

1/2" DRIVE

SOCKETS AND DRIVE TOOLS



18 PIECE 1/2" DRIVE SOCKET AND DRIVE TOOL SET



6 Point SAE, Packed in Exclusive Keep-Safe-Foam System with Metal Box



JHWWSS18HFTB

Product Code	Description
JHWWSS18HFTB	18 Piece Tool Set with JHWTB103 Metal Tool Box
JHWWSS-18HF	18 Piece Tool Set Only - Packed in Keep Safe Foam System

Contents Include:

Drive Tools:		Drive Tools:	
Product Code	Description	Product Code	Description
JHWS-41AA	15 1/2" Flex Handle	JHWS-110P	5" Extension
JHWS-52EHA	10 3/8" Enclosed Head Ratchet	JHWS-140A	Universal Joint

Shallow 6-Point Sockets		Shallow 6-Point Sockets	
Product Code	Size (Inches)	Product Code	Size (Inches)
JHWST-612	3/8	JHWST-626	13/16
JHWST-614	7/16	JHWST-628	7/8
JHWST-616	1/2	JHWST-630	15/16
JHWST-618	9/16	JHWST-632	1
JHWST-620	5/8	JHWST-634	1 1/16
JHWST-622	11/16	JHWST-636	1 1/8
JHWST-624	3/4	JHWST-640	1 1/4

Features

- Keep-Safe-Foam system keeps tools organized and helps prevent loss
- All tools are professional quality, made of high-grade chrome vanadium steel
- Sockets feature SUPERTORQUE™ lobular openings for greater turning power without deforming the fastener
- Metal tool box made for years of rugged use



15 PIECE 1/2" DRIVE SOCKET AND DRIVE TOOL SET



12 Point SAE, Packed in Exclusive Keep-Safe-Foam System with Metal Box



JHWWSS-15FTB

Product Code	Description
JHWWSS-15FTB	15 Piece Tool Set with JHWTB103 Metal Tool Box
JHWWSS-15F	15 Piece Tool Set Only - Packed in Keep Safe Foam System

Contents Include:

Drive Tools:		Shallow 12-Point Sockets	
Product Code	Description	Product Code	Size (Inches)
JHWS-41AA	15 1/2" Flex Handle	JHWST-1214	7/16
JHWS-52EHA	10 3/8" Enclosed Head Ratchet	JHWST-1216	1/2
JHWS-110P	5" Extension	JHWST-1218	9/16
JHWS-115P	10" Extension	JHWST-1220	5/8
JHWS-140A	Universal Joint	JHWST-1222	11/16
		JHWST-1224	3/4
		JHWST-1226	13/16
		JHWST-1228	7/8
		JHWST-1230	15/16
		JHWST-1232	1

Features

- Keep-Safe-Foam system keeps tools organized and helps prevent loss
- All tools are professional quality, made of high-grade chrome vanadium steel
- Sockets feature SUPERTORQUE™ lobular openings for greater turning power without deforming the fastener
- Metal tool box made for years of rugged use



1/2" DRIVE

SOCKETS AND DRIVE TOOLS

47 PIECE 1/2" DRIVE SOCKET AND DRIVE TOOL SET



12 Point Metric, with Metal Box

Product Code	Description
JHWMSS-47TB	47 Piece Tool Set with JHWTB-6124B Metal Tool Box (Keep Safe Foam Not Included)
JHWMSS-47F	47 Piece Tool Set Only - Packed in Keep Safe Foam System

Contents Include:

Drive Tools:		Shallow 12-Point Sockets	
Product Code	Description	Product Code	Size (MM)
JHWS-15A	18" Speeder Handle	JHWSTM-1210	10
JHWS-20A	12" Sliding T-Handle	JHWSTM-1211	11
JHWS-40AA	10 13/16" Flex Handle	JHWSTM-1212	12
JHWS-41AA	15 1/2" Flex Handle	JHWSTM-1213	13
JHWS-52EHA	10 3/8" Enclosed Head Ratchet	JHWSTM-1214	14
JHWS-60D	Stud Remover	JHWSTM-1215	15
JHWS-70	Ratchet Spinner Disk	JHWSTM-1216	16
JHWS-102P	2" Extension	JHWSTM-1217	17
JHWS-110P	5" Extension	JHWSTM-1218	18
JHWS-115P	10" Extension	JHWSTM-1219	19
JHWS-140A	Universal Joint	JHWSTM-1220	20

Deep 12-Point Sockets

Product Code	Size (MM)	Product Code	Size (MM)
JHWSMD-1213	13	JHWSTM-1221	21
JHWSMD-1214	14	JHWSTM-1222	22
JHWSMD-1215	15	JHWSTM-1223	23
JHWSMD-1216	16	JHWSTM-1224	24
JHWSMD-1217	17	JHWSTM-1225	25
JHWSMD-1218	18	JHWSTM-1226	26
JHWSMD-1219	19	JHWSTM-1227	27
JHWSMD-1221	21	JHWSTM-1228	28
JHWSMD-1222	22	JHWSTM-1229	29
JHWSMD-1224	24	JHWSTM-1230	30
JHWSMD-1227	27	JHWSTM-1232	32
JHWSMD-1230	30	JHWSTM-1234	34
		JHWSTM-1236	36



JHWMSS-47TB

Features

- All tools are professional quality, made of high-grade chrome vanadium steel
- Sockets feature SUPERTORQUE™ lobular openings for greater turning power without deforming the fastener
- Metal tool box made for years of rugged use

33 PIECE 1/2" DRIVE SOCKET AND DRIVE TOOL SET



12 Point Metric, with Metal Box

Product Code	Description
JHWMSS-33FTB	33 Piece Tool Set with JHWTB-104 Metal Tool Box
JHWMSS-33F	33 Piece Tool Set Only - Packed in Keep Safe Foam System

Contents Include:

Drive Tools:		Shallow 12-Point Sockets	
Product Code	Description	Product Code	Size (MM)
JHWS-41AA	15 1/2" Flex Handle	JHWSTM-1210	10
JHWS-52EHA	10 3/8" Enclosed Head Ratchet	JHWSTM-1211	11
JHWS-102P	2" Extension	JHWSTM-1212	12
JHWS-110P	5" Extension	JHWSTM-1213	13
JHWS-115P	10" Extension	JHWSTM-1214	14
JHWS-140A	Universal Joint	JHWSTM-1215	15

Deep 12-Point Sockets

Product Code	Size (MM)	Product Code	Size (MM)
JHWSMD-1213	13	JHWSTM-1216	16
JHWSMD-1214	14	JHWSTM-1217	17
JHWSMD-1215	15	JHWSTM-1218	18
JHWSMD-1216	16	JHWSTM-1219	19
JHWSMD-1217	17	JHWSTM-1220	20
JHWSMD-1218	18	JHWSTM-1221	21
JHWSMD-1219	19	JHWSTM-1222	22
JHWSMD-1221	21	JHWSTM-1223	23
JHWSMD-1222	22	JHWSTM-1224	24
JHWSMD-1224	24		
JHWSMD-1227	27		
JHWSMD-1230	30		



JHWMSS-33FTB

Features

- All tools are professional quality, made of high-grade chrome vanadium steel.
- Sockets feature SUPERTORQUE™ lobular openings for greater turning power without deforming the fastener.
- Metal tool box made for years of rugged use.

1/2" DRIVE

SOCKETS AND DRIVE TOOLS



29 PIECE 1/2" DRIVE SOCKET AND DRIVE TOOL SET



JHWSS-29FTB

12 Point Metric, Packed in Exclusive Keep-Safe-Foam System with Metal Box

Product Code	Description
JHWSS-29FTB	29 Piece Tool Set with JHWTB-104 Metal Tool Box
JHWSS-29F	29 Piece Tool Set Only - Packed in Keep Safe Foam System

Contents Include:

Drive Tools:		Drive Tools:	
Product Code	Description	Product Code	Description
JHWS-41AA	15 1/2" Flex Handle	JHWS-110P	5" Extension
JHWS-52EHA	10 3/8" Enclosed Head Ratchet	JHWS-115P	10" Extension
JHWS-102P	2" Extension	JHWS-140A	Universal Joint

Shallow 12-Point Sockets

Product Code	Size (MM)
JHWSTM-1210	10
JHWSTM-1211	11
JHWSTM-1212	12
JHWSTM-1213	13
JHWSTM-1214	14
JHWSTM-1215	15
JHWSTM-1216	16
JHWSTM-1217	17
JHWSTM-1218	18
JHWSTM-1219	19
JHWSTM-1220	20
JHWSTM-1221	21

Shallow 12-Point Sockets

Product Code	Size (MM)
JHWSTM-1222	22
JHWSTM-1223	23
JHWSTM-1224	24
JHWSTM-1225	25
JHWSTM-1226	26
JHWSTM-1227	27
JHWSTM-1228	28
JHWSTM-1229	29
JHWSTM-1230	30
JHWSTM-1232	32
JHWSTM-1234	34

Features

- Keep-Safe-Foam system keeps tools organized and helps prevent loss
- All tools are professional quality, made of high-grade chrome vanadium steel
- Sockets feature SUPERTORQUE™ lobular openings for greater turning power without deforming the fastener
- Metal tool box made for years of rugged use



22 PIECE 1/2" DRIVE SOCKET AND DRIVE TOOL SET



JHWSS-22FTB

12 Point Metric, Packed in Exclusive Keep-Safe-Foam System with Metal Box

Product Code	Description
JHWSS-22FTB	22 Piece Tool Set with JHWTB-104 Metal Tool Box
JHWSS-22F	22 Piece Tool Set Only - Packed in Keep Safe Foam System

Contents Include:

Drive Tools:		Drive Tools:	
Product Code	Description	Product Code	Description
JHWS-41AA	15 1/2" Flex Handle	JHWS-115P	10" Extension
JHWS-52EHA	10 3/8" Enclosed Head Ratchet	JHWS-140A	Universal Joint
JHWS-110P	5" Extension		

Shallow 6-Point Sockets

Product Code	Size (MM)
JHWSTM-1210	10
JHWSTM-1211	11
JHWSTM-1212	12
JHWSTM-1213	13
JHWSTM-1214	14
JHWSTM-1215	15
JHWSTM-1216	16
JHWSTM-1217	17
JHWSTM-1218	18

Shallow 12-Point Sockets

Product Code	Size (MM)
JHWSTM-1219	19
JHWSTM-1220	20
JHWSTM-1221	21
JHWSTM-1222	22
JHWSTM-1223	23
JHWSTM-1224	24
JHWSTM-1225	25
JHWSTM-1226	26

Features

- Keep-Safe-Foam system keeps tools organized and helps prevent loss
- All tools are professional quality, made of high-grade chrome vanadium steel
- Sockets feature SUPERTORQUE™ lobular openings for greater turning power without deforming the fastener
- Metal tool box made for years of rugged use



1/2" DRIVE

SOCKETS AND DRIVE TOOLS

20 PIECE 1/2" DRIVE SOCKET AND DRIVE TOOL SET



12 Point Metric, Packed in Exclusive Keep-Safe-Foam-System with Metal Box

Product Code	Description
JHWMSS-20FTB	20 Piece Tool Set with JHWTB-104 Metal Tool Box and Foam

Contents Include:

Drive Tools:

Product Code	Description
JHWS-41AA	15 1/2" Flex Handle
JHWS-52EHA	10 3/8" Enclosed Head Ratchet
JHWS-110P	5" Extension

Shallow 12-Point Sockets

Product Code	Size (mm)
JHWSTM-1210	10
JHWSTM-1213	13
JHWSTM-1214	14
JHWSTM-1215	15
JHWSTM-1217	17
JHWSTM-1218	18
JHWSTM-1219	19
JHWSTM-1220	20
JHWSTM-1221	21

Shallow 12-Point Sockets

Product Code	Size (mm)
JHWSTM-1222	22
JHWSTM-1223	23
JHWSTM-1224	24
JHWSTM-1226	26
JHWSTM-1227	27
JHWSTM-1230	30
JHWSTM-1232	32
JHWSTM-1236	36



JHWMSS-20FTB

Features

- All tools are professional quality, made of high grade special alloy steel
- Sockets feature SUPERTORQUE™ lobular openings for greater turning power without deforming the fastener
- Metal tool box made for years of rugged use



1/2" DRIVE

SOCKETS AND DRIVE TOOLS





JHW50614B

Features

- All tools are professional quality, made of high-grade chrome vanadium steel
- Sockets feature SUPERTORQUE™ lobular openings for greater turning power without deforming the fastener
- Packed in rugged high-density polyethylene (HDPE) cases that are strong and durable yet light in weight
- Case is shock proof at both high and low temperatures, equipped with heavy-duty metal latches and hinges
- Two-component handles are easy to grip and comfortable to carry

**146 PIECE
1/4", 3/8", 1/2" DRIVE
SOCKET AND DRIVE TOOL SET**



6 & 12 Point Rugged-Case-System Tool Set, SAE and Metric

Product Code	Description
JHW50614B	146 Piece 1/4", 3/8", 1/2" Drive Socket Set

**1/4" Drive
Contents Include:**

1/4" Drive Tools

Ratchet
3" Extension
Handle
Universal Joint

**1/4" Drive Deep
6 Point Sockets**

Metric Size (MM)	SAE Size (Inches)
4	3/16
5	7/32
6	1/4
7	9/32
8	5/16
9	11/32
10	3/8
11	7/16
12	1/2
13	

**1/4" Drive Shallow
6 Point Sockets**

Metric Size (MM)	SAE Size (Inches)
4	5/32
5	3/16
5.5	7/32
6	1/4
7	9/32
8	5/16
9	11/32
10	3/8
11	7/16
12	1/2
13	9/16
14	

**1/4" Drive
Hex Bit Sockets**

Metric Size (MM)	SAE Size (Inches)
3	1/8
4	5/32
5	3/16
6	7/32
7	1/4
8	5/16

**1/4" Drive Screw-
driver Bit Sockets**

Size	Size
5/32" Slotted Tip	#0 Phillips Tip
7/32" Slotted Tip	#1 Phillips Tip
9/32" Slotted Tip	#2 Phillips Tip

**1/4" Drive
Torx Bit Sockets**

Size	Size
T10	T25
T15	T27
T20	T30

**3/8" Drive
Contents Include:**

3/8" Drive Tools

Ratchet
3" Extension
6" Extension
Adaptor - 3/8" F x 1/4" M

**3/8" Drive Deep
12 Point Sockets**

Metric Size (MM)	SAE Size (Inches)
6	1/4
7	5/16
8	3/8
9	7/16
10	1/2
11	9/16
12	5/8
13	11/16
14	3/4
15	13/16
16	7/8
17	15/16
18	1
19	

**3/8" Drive Shallow
6 Point Sockets**

Metric Size (MM)	SAE Size (Inches)
6	1/4
7	5/16
8	3/8
9	7/16
10	1/2
11	9/16
12	5/8
13	11/16
14	3/4
15	13/16
16	7/8
17	15/16
18	1
19	

**3/8" Drive
Spark Plug Socket**

SAE Size (Inches)
5/8
13/16

**1/2" Drive
Contents Include:**

1/2" Drive Tools

Ratchet
6" Extension
10" Extension
Universal Joint
Adaptor - 1/2" F x 3/8" M

**1/2" Drive Shallow
12 Point Sockets**

SAE Size (Inches)
3/8
7/16
1/2
9/16
5/8
11/16
3/4
13/16
7/8
15/16
1

1/2" DRIVE

SOCKETS AND
DRIVE TOOLS

**138 PIECE
1/4", 3/8", 1/2" DRIVE
SOCKET AND DRIVE TOOL SET**



6 Point Rugged-Case-System Tool Set, SAE and Metric

Product Code	Description
JHW50612B	138 Piece 1/4", 3/8", 1/2" Drive Socket Set

1/4" Drive Contents Include:

1/4" Drive Tools

- Ratchet
- 1 1/2" Extension
- 3" Extension
- Spinner Handle
- Universal Joint
- Hex Bit Holder

13 Piece Insert Bit Set

1/4" Drive Deep 6 Point Sockets

Metric Size (MM)	SAE Size (Inches)
4	5/32
5	3/16
6	7/32
7	1/4
8	9/32
9	5/16
10	11/32
11	3/8
12	7/16
13	1/2

1/4" Drive Shallow 6 Point Sockets

Metric Size (MM)	SAE Size (Inches)
4	5/32
5	3/16
5.5	7/32
6	1/4
7	9/32
8	5/16
9	11/32
10	3/8
11	7/16
12	1/2
13	

3/8" Drive Contents Include:

3/8" Drive Tools

- Ratchet
- 3" Extension
- 6" Extension
- Universal Joint
- Adaptor
- Hex Bit Holder

3/8" Drive Deep 12 Point Sockets

Metric Size (MM)	SAE Size (Inches)
10	3/8
11	7/16
12	1/2
13	9/16
14	5/8
15	11/16
16	3/4
17	13/16
18	7/8
19	

3/8" Drive Shallow 6 Point Sockets

Metric Size (MM)	SAE Size (Inches)
10	3/8
11	7/16
12	1/2
13	9/16
14	5/8
15	11/16
16	3/4
17	
18	
19	

1/2" Drive Contents Include:

1/2" Drive Tools

- Ratchet
- 6" Extension
- 10" Extension
- Universal Joint
- Adaptor

1/2" Drive Shallow 12 Point Sockets

Metric Size (MM)	SAE Size (Inches)
10	3/8
11	7/16
12	1/2
13	9/16
14	5/8
15	11/16
16	3/4
17	13/16
18	7/8
19	1
21	1
22	1 1/16
24	1 1/8
27	1 3/16
30	1 1/4
32	



JHW50612B

Features

- All tools are professional quality, made of high-grade chrome vanadium steel
- Sockets feature SUPERTORQUE™ lobular openings for greater turning power without deforming the fastener
- Packed in rugged high-density polyethylene (HDPE) cases that are strong and durable yet light in weight
- Case is shock proof at both high and low temperatures, equipped with heavy-duty metal latches and hinges
- Two-component handles are easy to grip and comfortable to carry

1/2" DRIVE

SOCKETS AND DRIVE TOOLS



61 PIECE 1/2" DRIVE SOCKET AND TOOL SET



12 Point Rugged-Case-System Tool Set, SAE and Metric

Product Code	Description
JHW50617B	61 Piece Socket, Wrench, and Screwdriver Set

1/2" Drive Contents Include:

1/2" Drive Tools	1/2" Drive Shallow 12 Point Sockets		12 Point Combination Wrenches	
	Metric Size (MM)	SAE Size (Inches)	Metric Size (MM)	SAE Size (Inches)
Ratchet				
3" Extension			6	1/4
6" Extension	10	3/8	8	5/16
10" Extension	11	7/16	10	3/8
15- 1/2" Flex Handle	12	1/2	12	7/16
Universal Joint	13	9/16	13	1/2
Adaptor	14	5/8	14	9/16
Adaptor 1/2 F x 3/4 M	15	11/16	15	5/8
	16	3/4	17	11/16
	17	13/16	19	3/4
	18	7/8		
	19	15/16		
	21	1		
	22	1 1/16		
	24	1 1/8		
	27	1 3/16		
	30	1 1/4		
	32			

Comfort Grip Screwdrivers
3/16" x 4" Slotted
1/4" x 4" Slotted
1 x 3" Phillips
2 x 4" Phillips



JHW50617B

Features

- All tools are professional quality, made of high-grade chrome vanadium steel
- Sockets feature SUPERTORQUE™ lobular openings for greater turning power without deforming the fastener
- Packed in rugged high-density polyethylene (HDPE) cases that are strong and durable yet light in weight
- Case is shock proof at both high and low temperatures, equipped with heavy-duty metal latches and hinges
- Two-component handles are easy to grip and comfortable to carry

1/2" DRIVE

SOCKETS AND DRIVE TOOLS

23 PIECE 1/2" DRIVE BASIC TOOL SET



12 Point Rugged-Case-System Tool Set, SAE

Product Code	Description
JHW50609	23 Piece Basic Tool Set, SAE

Contents Include:

1/2" Drive Tools		1/2" Drive Shallow 12-Point Sockets
Description		Size (Inches)
9 7/8" Quick-Release Ratchet		3/8
3" Extension		7/16
6" Extension		1/2
10" Extension		9/16
15" Flex Handle Breaker Bar		5/8
Universal Joint		11/16
1/2" FX 3/8" M Adapter		3/4
1/2" FX 3/4" M Adapter		13/16
		7/8
		15/16
		1
		1 1/16
		1 1/8
		1 3/16
		1 1/4



JHW50609

25 PIECE 1/2" DRIVE BASIC TOOL SET



12 Point Rugged-Case-System Tool Set, Metric

Product Code	Description
JHW50619	25 Piece Basic Tool Set, Metric

Contents Include:

1/2" Drive Tools		1/2" Drive Shallow 12-Point Sockets
Description		Size (MM)
9 7/8" Quick-Release Ratchet		10
3" Extension		11
6" Extension		12
10" Extension		13
15" Flex Handle Breaker Bar		14
Universal Joint		15
1/2" FX 3/8" M Adapter		16
1/2" FX 3/4" M Adapter		17
		18
		19
		20
		21
		22
		24
		27
		30
		32



JHW50619

Features

- All tools are professional quality, made of high-grade chrome vanadium steel
- Sockets feature SUPERTORQUE™ lobular openings for greater turning power without deforming the fastener
- Packed in rugged high-density polyethylene (HDPE) cases that are strong and durable yet light in weight
- Case is shock proof at both high and low temperatures, equipped with heavy-duty metal latches and hinges
- Two-component handles are easy to grip and comfortable to carry

1/2" DRIVE

SOCKETS AND DRIVE TOOLS



JHW50668

23 PIECE 1/2" DRIVE SOCKET AND DRIVE TOOL SET



12 Point Compact Case Tool Set, SAE

Product Code	Description
JHW50668	23 Piece 1/2" Drive Socket and Drive Tool Set

Contents Include:

1/2" Drive Tools Description	1/2" Drive Deep 12 Point Sockets Size (Inches)	1/2" Drive Shallow 12 Point Sockets Size (Inches)
9 7/8" Pear Head Ratchet	1/2	7/16
15 1/2" Flex Handle	9/16	1/2
6" Extension	5/8	9/16
	11/16	5/8
	3/4	11/16
	13/16	3/4
	7/8	13/16
		7/8
		15/16
		1
		1 1/16
		1 1/8
		1 1/4



JHW50667

12 PIECE 1/2" DRIVE SOCKET AND DRIVE TOOL SET



12 Point Compact Case Tool Set, SAE

Product Code	Description
JHW50667	12 Piece 1/2" Drive Socket and Drive Tool Set

Contents Include:

1/2" Drive Tools Description	1/2" Drive Shallow 12 Point Sockets Size (Inches)
9 7/8" Pear Head Ratchet	1/2
6" Extension	9/16
	5/8
	11/16
	3/4
	13/16
	7/8
	15/16
	1
	1 1/8



JHW50669

12 PIECE 1/2" DRIVE SOCKET AND DRIVE TOOL SET



12 Point Compact Case Tool Set, MM

Product Code	Description
JHW50669	12 Piece 1/2" Drive Socket and Drive Tool Set

Contents Include:

1/2" Drive Tools Description	1/2" Drive Shallow 12 Point Sockets Size (Inches)
9 7/8" Pear Head Ratchet	12
6" Extension	13
	14
	15
	16
	17
	18
	19
	22
	24

Features

- All tools are professional quality, made of high-grade chrome vanadium steel
- Sockets feature SUPERTORQUE™ lobular openings for greater turning power without deforming the fastener
- Packed in rugged compact high-density polyethylene (HDPE) cases that are strong and durable yet light in weight

1/2" DRIVE

SOCKETS AND
DRIVE TOOLS

1/2" DRIVE ENCLOSED HEAD RATCHETS

Williams® Sealed Narrow Head Design,
Chrome and Black Industrial Finish

Product Code	Description	Length (Inches)	Number of Teeth
JHWS-52EHA	Chrome Finish Enclosed Head Ratchet	10 ¼	36
JHWS-52EHLA	Chrome Finish Enclosed Head Ratchet, Long	15	36
JHWSB-52EHLA	Black Industrial Finish Enclosed Head Ratchet, Long	15	36
JHWS-52EHFA	Chrome Finish Flex Head Ratchet	14 ¼	36
JHWSB-52EHA	Black Industrial Finish Enclosed Head Ratchet	10 ¼	36
JHWS-52EHRKA	Repair Kit "EHA" Model Enclosed Head Ratchets		

Fed. Spec: ANSI B107.10M

Features

- Enclosed head is sealed to prevent dust, dirt, and liquids from entering head, preserving internal lubrication
- Forged one-piece ratchet provide strength and safety for industrial applications
- Smooth comfort-grip handle permits all-day use without gloves
- 36 tooth gear with 10 degree of engagement allows engagement in tight working areas
- Nickel/Chrome plating provides increase protection from rust and corrosion
- Chrome finish models feature mirror-like exterior that can be easily cleaned after each use
- Single Pawl ratchet design
 - 1) Designed for tighter tolerances between pawl and gear which reduces metal fatigue and slippage under load
 - 2) Does not require as many working parts, reducing possible breakage and parts to repair
- Easy access reverse lever allows user to change working direction quickly and easily with only one hand



Made in U.S.A.



JHWSB-52EHA



JHWS-52EHLA



JHWSB-52EHLA



JHWS-52EHFA



JHWS-52EHA

1/2" DRIVE ROUND HEAD RATCHETS

Knurled Handle, Chrome and Black Industrial Finish

Product Code	Description	Length (Inches)	Number of Teeth
JHWS-52A	Chrome Finish Round Head Ratchet	11 5/16	72
JHWS-53A	Chrome Finish Round Head Ratchet, Long	15	72
JHWSB-52A	Black Industrial Finish Round Head Ratchet	11 5/16	72
JHWS-52ARK	Repair Kit		

Fed. Spec: ANSI B107.10M

Features

- Double pawl design with 72 teeth action provides a 5° ratcheting angle
- Shift lever reverses action instantly
- Knurled handle provides a non-slip grip
- Chrome finish models provides increased protection from rust and corrosion



Made in U.S.A.



JHWS-52A



JHWS-53A



JHWSB-52A

1/2" DRIVE ROUND HEAD LINEMAN'S RATCHET

Knurled Handle, Chrome Finish

Product Code	Description	Length (Inches)	Number of Teeth
JHWS-52LAB	Round Head Lineman's Ratchet	11 5/16	72
JHWS-52LARK	Repair Kit		

Fed. Spec: ANSI B107.10M

Features

- Same features as other Williams' round head ratchets
- Extra-large shift lever allows easy reversal even when wearing gloves



Made in U.S.A.



JHWS-52LAB

1/2" DRIVE

SOCKETS AND
DRIVE TOOLS





JHWS-71CBA



BS-63A



JHWS-63B



JHWS-40AA



JHWSB-40AA



JHWS-41AA

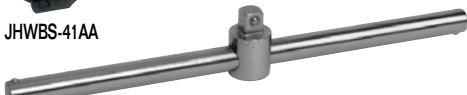

JHWS-20A



JHWS-10A



JHWS-15A



JHWS-41AA

1/2" DRIVE NARROW HEAD CONSTRUCTION RATCHET

Knurled Handle, Black Industrial Finish

Product Code	Description	Length (Inches)	Number of Teeth
JHWS-71CBA	Narrow Head Construction Ratchet	15 13/16	36
JHWS-71ARKA	Repair Kit		

Fed. Spec: ANSI B107.10M

Features

- 36 tooth gear with 10 degree of engagement allows engagement in tight working areas
- Extra-large shift lever reverses action instantly and easily, even when wearing gloves
- Tapered spud handle easily lines up bolt holes



Made in U.S.A.

1/2" DRIVE SCAFFOLDING RATCHET

Product Code	Description	Product Code	Description
JHWS-62	Scaffolding Ratchet with out pry bar	JHWS-63BTIP	Hammer Tip
BS-63A	Scaffolding Ratchet with reversed pry bar	JHWS-63BBAR	Pry Bar
JHWS-63B	Scaffolding Ratchet with pry bar		
JHWS-63BRK	Repair Kit		

Features

- 1/2" Drive with pinned 7/8" 6-point socket, 2-1/4" length
- 36 tooth gear with 10 degree of engagement allows engagement in tight working areas
- Bronze hammer head reduces rebound
- Pry bar handle provide alignment option
- Socket feature SUPERTORQUE™ lobular opening for greater turning power without deforming the fastener
- Easy access reversing lever allows user to change working direction quickly and easily with only one hand
- Tethering device attached to handle
- Repair kit includes ratchet repair kit and cover plate



Made in U.S.A.

1/2" DRIVE HANDLES

Knurled Handle, Chrome and Black Industrial Finish

Product Code	Description	Length (Inches)
JHWS-40AA	Chrome Flex Handle	10 13/16
JHWSB-40AA	Black Industrial Finish Flex Handle	10 13/16
JHWS-41AA	Chrome Flex Handle	15 1/2
JHWSB-41AA	Black Industrial Finish Flex Handle	15 1/2
JHWS-20A	Sliding T-Handle	12
JHWS-10A	Speeder Handle	13 5/8
JHWS-15A	Speeder Handle	18 1/16
JHWS-41RK	Flex Handle Repair Kit	

Fed. Spec: ANSI B107.10M

Features

- Chrome plating provides increased protection from rust and corrosion
- Drive handles provide extra leverage with greater strength than ratchets
- Speeder handle is ideal for fast turn down of fasteners



Made in U.S.A.

1/2" DRIVE EXTENSIONS AND ACCESSORIES

High-Polished Chrome Finish

Product Code	Description	Length (Inches)
JHWS-102P	Extension	2
JHWS-110P	Extension	5
JHWS-115P	Extension	10
JHWS-121P	Extension	20
JHWS-140A	Universal Joint	2 11/16
JHWS-70	Ratchet Spinner Disk	1 9/16

Fed. Spec: ANSI B107.10M

JHWSS-3XT 3 Piece Extension Set in Pouch

Contents Include:

Product Code	Size (Inches)
JHWS-102P	2
JHWS-110P	5
JHWS-115P	10

Features

- Chrome plating provides increased protection from rust and corrosion
- Ball and spring socket retention
- Spinner disk is ideal for fast turn down of fasteners



Made in U.S.A.

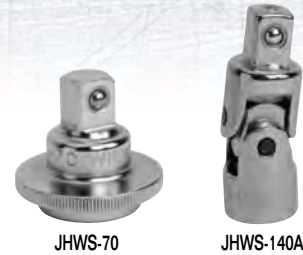

JHWS-70

JHWS-140A



JHWSS-3XT

JHWS-110P

1/2" DRIVE ADAPTORS AND EXTENSION ADAPTORS

High-Polished Chrome and Black Oxide Finish

Product Code	Length (Inches)	Male End (Inches)	Female End (Inches)
Chrome Finish Adapter			
JHWSH-130	1 15/16	3/4	1/2
Black Industrial Finish Adapters			
JHWSH-130B	1 15/16	3/4	1/2
JHWSH-131BF	2 3/16	1/2	3/4
Black Industrial Finish Extension Adapters			
JHWBS-05B	5	3/8	1/2
JHWBS-12B	12	3/8	1/2

Fed. Spec: ANSI B107.10M

Features

- Ball and spring socket retention
- Extension adapters offer convenience of extension and adapter in one tool



Made in U.S.A.



JHWBS-05B

JHWBS-12B



JHWSH-130

JHWSH-131BF

JHWSH-130B

1/2" DRIVE STUD REMOVER

Satin Chrome Finish

Product Code	Description	Length (Inches)	Capacity (Inches)
S-60E	Stud Remover	2 7/16	1/2 to 3/4

Fed. Spec: ANSI B107.10M

Features

- Knurled wheel grips studs during removal
- Drive shank extends through both sides of housing for even bearing surface
- Capacity is 1/2" to 3/4" stud diameter



Made in U.S.A.



S-60E



1/2" DRIVE RATCHETS AND HANDLES

High-Polished Chrome Finish

Product Code	Description	Length (Inches)
JHW11920	Flex Handle, Comb, 3/8" x 1/2" Drive	10

Fed. Spec: ANSI B107.10M

Features

- High-polished chrome finish for easy cleaning
- Unique combination 3/8" x 1/2" drive flex handle offers convenience of both drive sizes on one handle

1/2" DRIVE LOCKING EXTENSIONS

High-Polished Chrome Finish

Product Code	Description	Length (Inches)
JHW32023	Locking Extension	3
JHW32024	Locking Extension	6
JHW32025	Locking Extension	10
JHW32026	Locking Extension	12
JHW32027	Locking Extension	18
JHW32028	Locking Extension	24

Fed. Spec: ANSI B107.10M

Features

- Chrome plating provides increased protection from rust and corrosion

1/2" WOBBLE EXTENSIONS

High-Polished Chrome Finish

Product Code	Length (Inches)
JHWS-202P	2
JHWS-205P	5
JHWS-211P	11
JHWS-220P	20

Features

- Chrome plating provides increased protection from rust and corrosion
- Provides 16 degrees of additional accessibility

6 PIECE 1/2" DRIVE RATCHET AND DRIVE TOOL SET

Furnished in a Pouch

Product Code	Description
JHWDTS-6	6 Piece 1/2" Drive Ratchet and Accessory Set

Contents Include:

Product Code	Description
JHWS-52EHA	Chrome Finished Enclosed Head Ratchet
JHWS-102P	2" Extension
JHWS-115P	10" Extension
JHWS-41AA	Chrome Flex Handle
JHWS-140A	Universal Joint
JHWS-20A	Sliding T-Handle

Features

- All tools are professional quality, made of high-grade chrome vanadium steel

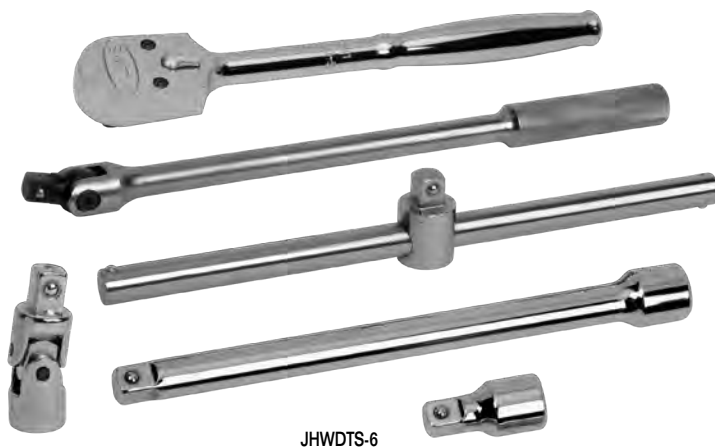

1/2" DRIVE

SOCKETS AND
DRIVE TOOLS

1/2" DRIVE SHALLOW 12 POINT SOCKETS, SAE



High-Polished Chrome Finish

Product Code	Size (Inches)	A		B		C		D		E		F	
		OAL (Inches)	Drive End Diameter (Inches)	Working End Diameter (Inches)	Broach Depth (Inches)	Bolt Clearance Depth (Inches)	Bolt Clearance Diameter (Inches)	Nose Length (Inches)					
JHWST-1212	3/8	1 1/2	29/32	19/32	5/16	7/8	1 1/32	23/32					
JHWST-1214	7/16	1 1/2	29/32	21/32	3/8	7/8	19/32	23/32					
JHWST-1216	1/2	1 1/2	29/32	3/4	3/8	7/8	15/32	23/32					
JHWST-1218	9/16	1 1/2	29/32	13/16	3/8	7/8	15/32	23/32					
JHWST-1219	19/32	1 1/2	29/32	7/8	3/8	7/8	15/32	23/32					
JHWST-1220	5/8	1 1/2	29/32	29/32	9/16	7/8	19/32	-					
JHWST-1221	21/32	1 1/2	31/32	19/32	19/32	7/8	19/32	-					
JHWST-1222	11/16	1 1/2	31/32	31/32	13/16	27/32	5/8	-					
JHWST-1224	3/4	1 1/2	1 1/32	1 1/32	13/16	27/32	29/32	-					
JHWST-1225	25/32	1 1/2	1 1/16	1 1/16	13/16	27/32	3/4	-					
JHWST-1226	19/16	1 1/2	1 1/8	1 1/8	13/16	27/32	25/32	-					
JHWST-1228	7/8	1 1/2	1 3/16	1 3/16	13/16	13/16	7/8	-					
JHWST-1230	15/16	1 17/32	1 9/32	1 9/32	13/16	27/32	29/32	-					
JHWST-1231	31/32	1 9/16	1 5/16	1 5/16	1 9/16	27/32	7/8	19/16					
JHWST-1232	1	1 9/16	1 11/32	1 11/32	1 1/32	27/32	7/8	31/32					
JHWST-1234	1 1/16	1 11/16	1 7/16	1 7/16	1 3/32	1	1 1/16	-					
JHWST-1236	1 1/8	1 3/4	1 1/2	1 1/2	1 1/32	1 1/16	1 1/8	-					
JHWST-1238	1 3/16	1 3/4	1 5/8	1 5/8	1	1 1/32	1 5/32	-					
JHWST-1240	1 1/4	1 7/8	1 11/16	1 11/16	1 1/8	1 5/32	1 1/4	-					
JHWST-1242	1 5/16	1 7/8	1 3/4	1 3/4	1 1/32	1 5/32	1 9/32	-					
JHWST-1244	1 3/8	2 1/16	1 13/16	1 13/16	1	1 5/16	1 11/32	-					
JHWST-1246	1 7/16	2 1/4	1 15/16	1 15/16	1 1/32	1 1/2	1 1/8	-					
JHWST-1248	1 1/2	2 1/4	2	2	1 1/16	1 1/2	1 1/8	-					

Fed. Spec: ANSI B107.110



JHWST-1220

JHWST-1212

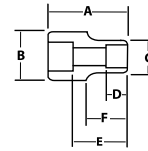

JHWWSS-15RC 15 Piece 1/2" Drive Shallow 12-Point Socket Set on Clip Rail

Contents Include:

Product Code	Size (Inches)	Product Code	Size (Inches)	Product Code	Size (Inches)
JHWST-1212	3/8	JHWST-1222	11/16	JHWST-1232	1
JHWST-1214	7/16	JHWST-1224	3/4	JHWST-1234	1 1/16
JHWST-1216	1/2	JHWST-1226	13/16	JHWST-1236	1 1/8
JHWST-1218	9/16	JHWST-1228	7/8	JHWST-1238	1 3/16
JHWST-1220	5/8	JHWST-1230	15/16	JHWST-1240	1 1/4

JHWWSS-23RC 23 Piece 1/2" Drive Shallow 12-Point Socket Set on Clip Rail

Contents Include:

Product Code	Size (Inches)	Product Code	Size (Inches)	Product Code	Size (Inches)	Product Code	Size (Inches)
JHWST-1212	3/8	JHWST-1221	21/32	JHWST-1230	15/16	JHWST-1240	1 1/4
JHWST-1214	7/16	JHWST-1222	11/16	JHWST-1231	31/32	JHWST-1242	1 5/16
JHWST-1216	1/2	JHWST-1224	3/4	JHWST-1232	1	JHWST-1244	1 3/8
JHWST-1218	9/16	JHWST-1225	25/32	JHWST-1234	1 1/16	JHWST-1246	1 7/16
JHWST-1219	19/32	JHWST-1226	13/16	JHWST-1236	1 1/8	JHWST-1248	1 1/2
JHWST-1220	5/8	JHWST-1228	7/8	JHWST-1238	1 3/16		

Features

- SUPERTORQUE™ lobular openings for greater turning power without deforming the fastener
- Designed for quick engagement on both 6 and 12 point fasteners



JHWWSS-15RC



JHWWSS-23RC

1/2" DRIVE

SOCKETS AND DRIVE TOOLS



1/2" DRIVE SHALLOW SOCKETS, 6 POINT, SAE



JHWST-620

JHWST-612

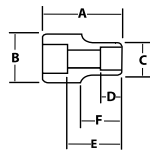

High-Polished Chrome Finish

Product Code	Size (Inches)	A (Inches)	B (Inches)	C (Inches)	D (Inches)	E (Inches)	F (Inches)
JHWST-612	3/8	1 1/2	29/32	19/32	5/16	7/8	23/32
JHWST-614	7/16	1 1/2	29/32	21/32	3/8	7/8	23/32
JHWST-616	1/2	1 1/2	29/32	3/4	3/8	7/8	23/32
JHWST-618	9/16	1 1/2	29/32	13/16	3/8	7/8	23/32
JHWST-619	19/32	1 1/2	29/32	7/8	3/8	7/8	23/32
JHWST-620	5/8	1 1/2	29/32	29/32	9/16	7/8	15/32
JHWST-622	11/16	1 1/2	31/32	31/32	13/16	27/32	5/8
JHWST-624	3/4	1 1/2	1 1/32	1 1/32	13/16	27/32	23/32
JHWST-625	25/32	1 1/2	1 1/16	1 1/16	13/16	27/32	3/4
JHWST-626	13/16	1 1/2	1 1/8	1 1/8	13/16	27/32	25/32
JHWST-628	7/8	1 1/2	1 3/16	1 3/16	13/16	13/16	7/8
JHWST-630	15/16	1 17/32	1 9/32	1 9/32	13/16	27/32	29/32
JHWST-632	1	1 9/16	1 11/32	1 11/32	27/32	7/8	31/32
JHWST-634	1 1/16	1 11/16	1 7/16	1 7/16	31/32	1	1 1/16
JHWST-636	1 1/8	1 3/4	1 1/2	1 1/2	1 1/32	1 1/16	1 1/8
JHWST-640	1 1/4	1 7/8	1 11/16	1 11/16	1 1/8	1 5/32	1 1/4

Fed. Spec: ANSI B107.1

JHWSS-14HRC

14 Piece 1/2" Drive Shallow 6 Point Socket Set on Clip Rail

Contents Include:

Product Code	Size (Inches)	Product Code	Size (Inches)	Product Code	Size (Inches)
JHWST-612	3/8	JHWST-622	11/16	JHWST-632	1
JHWST-614	7/16	JHWST-624	3/4	JHWST-634	1 1/16
JHWST-616	1/2	JHWST-626	13/16	JHWST-636	1 1/8
JHWST-618	9/16	JHWST-628	7/8	JHWST-640	1 1/4
JHWST-620	5/8	JHWST-630	15/16		

Features

- SUPERTORQUE™ lobular openings for greater turning power without deforming the fastener
- Designed for maximum engagement on 6 point fasteners



Made in U.S.A.



JHWSS-14HRC

1/2" DRIVE

SOCKETS AND
DRIVE TOOLS

1/2" DRIVE CROWFOOT WRENCH, OPEN END SAE



Satin Chrome Finish, SAE

Product Code	Size (Inches)	A Outside Diameter (Inches)	C Center to Center (Inches)	E Head Depth (Inches)	F Total Depth (Inches)
JHWSCO30	15/16"	1 27/32	1 15/32	11/32	5/8
JHWSCO32	1"	1 31/32	1 11/16	23/64	5/8
JHWSCO34	1 1/16"	2 3/32	1 3/4	3/8	5/8
JHWSCO36	1 1/8"	2 7/32	1 3/4	3/8	5/8
JHWSCO38	1 3/16"	2 11/32	1 3/4	13/32	5/8
JHWSCO40	1 1/4"	2 15/32	2	13/32	5/8
JHWSCO42	1 5/16"	2 19/32	2	7/16	5/8
JHWSCO44	1 3/8"	2 23/32	2	7/16	5/8
JHWSCO46	1 7/16"	2 27/32	2	7/16	5/8
JHWSCO48	1 1/2"	2 31/32	2	15/32	5/8
JHWSCO50	1 9/16"	2 31/32	1 31/32	15/32	5/8
JHWSCO52	1 5/8"	3 7/32	1 31/32	1/2	5/8
JHWSCO54	1 11/16"	3 1/8	2 3/16	1/2	5/8
JHWSCO56	1 3/4"	3 15/32	2 9/16	17/32	5/8
JHWSCO58	1 13/16"	3 19/32	2 3/16	17/32	5/8
JHWSCO60	1 7/8"	3 23/32	2 3/16	9/16	5/8
JHWSCO64	2"	3 31/32	2 7/32	9/16	5/8
JHWSCO68	2 1/8"	3 31/32	2 7/32	37/64	5/8
JHWSCO72	2 1/4"	3 31/32	2 13/32	37/64	5/8
JHWSCO76	2 3/8"	4 3/8	2 31/64	19/32	5/8
JHWSCO78	2 7/16"	4 3/8	2 7/16	19/32	5/8
JHWSCO80	2 1/2"	4 3/8	2 13/32	19/32	5/8



JHWSCO48

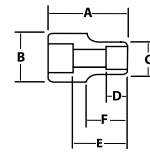

JHWWSCO-E-7

7 Piece 1/2" Drive Crowfoot Wrenches on Clip Rails, SAE

Contents Include:

Product Code	Size (Inches)	Product Code	Size (Inches)	Product Code	Size (Inches)
JHWSCO30	15/16"	JHWSCO36	1 1/8"	JHWSCO48	1 1/2"
JHWSCO32	1"	JHWSCO40	1 1/4"		
JHWSCO34	1 1/16"	JHWSCO46	1 7/16"		

Features

- Crowfoot wrenches are professional quality, made of high grade steel
- Featuring an open end with a continuous arc for constant contact with the fastener for greater turning power without deforming the fastener



JHWWSCO-E-7

1/2" DRIVE

SOCKETS AND DRIVE TOOLS



1/2" DRIVE CROWFOOT WRENCH, FLARE NUT, 12 POINT



Satin Chrome Finish, SAE

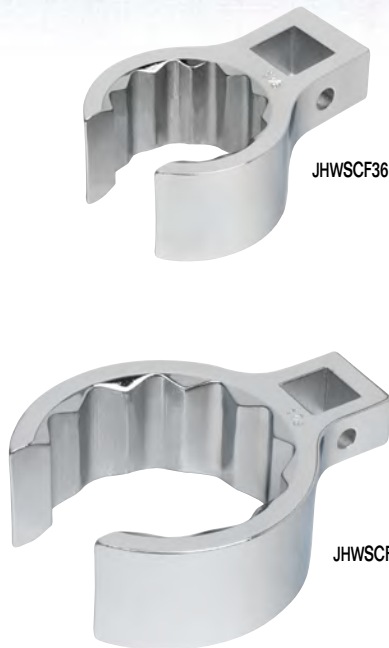

Product Code	Size (Inches)	Diameter of Head	Thickness of Head	C	D
JHWSCF36	1 1/8	1 3/8	7/8	27/32	1 5/32
JHWSCF38	1 3/16	1 11/16	7/8	27/32	1 3/16
JHWSCF40	1 1/4	1 25/32	7/8	15/16	1 15/64
JHWSCF42	1 5/16	1 27/32	7/8	31/32	1 17/64
JHWSCF44	1 3/8	1 15/16	15/16	1 1/16	1 5/16
JHWSCF46	1 7/16	2	15/16	1 1/16	1 11/32
JHWSCF48	1 1/2	2 1/16	15/16	1 1/8	1 3/8
JHWSCF50	1 9/16	2 5/32	15/16	1 5/32	1 27/64
JHWSCF52	1 5/8	2 7/32	15/16	1 7/32	1 29/64
JHWSCF54	1 11/16	2 9/16	1	1 5/16	1 33/64
JHWSCF56	1 3/4	2 3/8	1	1 5/16	1 35/64
JHWSCF58	1 13/16	2 15/32	1	1 11/32	1 19/32
JHWSCF60	1 7/8	2 9/16	1 1/16	1 3/8	1 41/64
JHWSCF62	1 15/16	2 1/2	1 1/16	1 7/16	1 43/64
JHWSCF64	2	2 23/32	1 1/16	1 9/16	1 23/32

Fed. Spec: ASME B107.21 Type 1 Class 1

JHWSSCF-7 7 Piece 12 Point Crowfoot Wrench on Clip Rail Contents Include:

Product Code	Size (Inches)	Product Code	Size (Inches)	Product Code	Size (Inches)
JHWSCF36	1 1/8	JHWSCF42	1 5/16	JHWSCF46	1 7/16
JHWSCF38	1 3/16	JHWSCF44	1 3/8	JHWSCF48	1 1/2
JHWSCF40	1 1/4				

JHWSSCF-15 15 Piece 12 Point Crowfoot Wrench on Clip Rail Contents Include:

Product Code	Size (Inches)	Product Code	Size (Inches)	Product Code	Size (Inches)	Product Code	Size (Inches)
JHWSCF36	1 1/8	JHWSCF44	1 3/8	JHWSCF52	1 5/8	JHWSCF60	1 7/8
JHWSCF38	1 3/16	JHWSCF46	1 7/16	JHWSCF54	1 11/16	JHWSCF62	1 15/16
JHWSCF40	1 1/4	JHWSCF48	1 1/2	JHWSCF56	1 3/4	JHWSCF64	2
JHWSCF42	1 5/16	JHWSCF50	1 9/16	JHWSCF58	1 13/16		

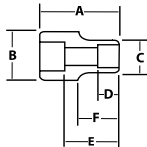

Features

- All tools are professional quality, made of high grade steel
- High-polished chrome finish cleans easily



JHWSSCF-7



JHWSSCF-15

1/2" DRIVE SHALLOW SOCKETS, 8 POINT, SAE



High-Polished Chrome Finish

Product Code	Size (Inches)	A (Inches)	B (Inches)	C (Inches)	D (Inches)	E (Inches)	F (Inches)
JHWST-812	3/8	1 1/2	7/8	23/32	5/16	27/32	7/8
JHWST-814	7/16	1 1/2	7/8	13/16	3/8	27/32	7/8
JHWST-816	1/2	1 1/2	29/32	29/32	13/32	27/32	-
JHWST-818	9/16	1 1/2	31/32	31/32	7/16	27/32	-
JHWST-820	5/8	1 1/2	1 1/16	1 1/16	1/2	27/32	-
JHWST-822	11/16	1 1/2	1 3/16	1 3/16	1/2	27/32	-
JHWST-824	3/4	1 1/2	1 9/32	1 9/32	9/16	13/16	-
JHWST-826	13/16	1 5/8	1 7/16	1 7/16	9/16	31/32	-
JHWST-828	7/8	1 3/4	1 1/2	1 1/2	5/8	1 1/16	-
JHWST-830	15/16	1 13/16	1 5/8	1 5/8	11/16	1 1/8	-
JHWST-832	1	1 15/16	1 11/16	1 11/16	1 1/16	1 1/4	-
JHWST-834	1 1/16	1 15/16	1 3/4	1 3/4	23/32	1 1/8	-
JHWST-836	1 1/8	2	1 13/16	1 13/16	3/4	1 3/16	-
JHWST-840	1 1/4	2	2	2	25/32	1 3/16	-

Fed. Spec: ANSI B107.110

JHWSS-810RC 10 Piece 1/2" Drive Shallow 8 Point Socket Set on Clip Rail

Contents Include:

Product Code	Size (Inches)	Product Code	Size (Inches)	Product Code	Size (Inches)
JHWST-812	3/8	JHWST-820	5/8	JHWST-826	13/16
JHWST-814	7/16	JHWST-822	11/16	JHWST-828	7/8
JHWST-816	1/2	JHWST-824	3/4	JHWST-830	15/16
JHWST-818	9/16				

JHWSS-814RC 14 Piece 8 Point Socket Set on Clip Rail

Contents Include:

Product Code	Size (Inches)	Product Code	Size (Inches)	Product Code	Size (Inches)
JHWST-812	3/8	JHWST-820	5/8	JHWST-828	7/8
JHWST-814	7/16	JHWST-822	11/16	JHWST-830	15/16
JHWST-816	1/2	JHWST-824	3/4	JHWST-832	1
JHWST-818	9/16	JHWST-826	13/16	JHWST-834	1 1/16
				JHWST-836	1 1/8
				JHWST-840	1 1/4



Made in U.S.A.

1/2" DRIVE DEEP SOCKETS, 12 POINT, SAE



High-Polished Chrome Finish

Product Code	Size (Inches)	A (Inches)	B (Inches)	C (Inches)	D (Inches)	E (Inches)	F (Inches)
JHWSD-1216	1/2	3 1/4	29/32	3/4	13/32	2 19/32	2 15/32
JHWSD-1218	9/16	3 1/4	29/32	13/16	7/16	2 19/32	2 19/32
JHWSD-1220	5/8	3 1/4	29/32	29/32	15/32	2 7/16	-
JHWSD-1222	11/16	3 1/4	31/32	31/32	17/32	2 11/32	-
JHWSD-1224	3/4	3 1/4	1 1/16	1 1/16	19/32	2 5/16	-
JHWSD-1225	25/32	3 1/4	1 1/16	1 1/16	21/32	2 9/32	-
JHWSD-1226	13/16	3 1/4	1 1/8	1 1/8	21/32	2 9/32	-
JHWSD-1228	7/8	3 1/4	1 3/16	1 3/16	23/32	2 9/32	-
JHWSD-1230	15/16	3 1/4	1 9/32	1 9/32	3/4	2 9/32	-
JHWSD-1232	1	3 1/4	1 11/32	1 11/32	3/4	2 1/4	-
JHWSD-1234	1 1/16	3 1/4	1 7/16	1 7/16	3/4	2 1/4	-
JHWSD-1236	1 1/8	3 1/4	1 1/2	1 1/2	25/32	2 1/4	-

Fed. Spec: ANSI B107.110

JHWSSD-11RC 11 Piece 1/2" Drive Deep 12 Point Socket Set on Clip Rail

Contents Include:

Product Code	Size (Inches)	Product Code	Size (Inches)	Product Code	Size (Inches)
JHWSD-1216	1/2	JHWSD-1224	3/4	JHWSD-1232	1
JHWSD-1218	9/16	JHWSD-1226	13/16	JHWSD-1234	1 1/16
JHWSD-1220	5/8	JHWSD-1228	7/8	JHWSD-1236	1 1/8
JHWSD-1222	11/16	JHWSD-1230	15/16		



Made in U.S.A.



JHWST-824

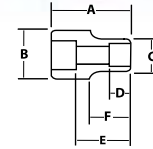

JHWSS-810RC



JHWSS-814RC

Features

- SUPERTORQUE™ lobular openings for greater turning power without deforming the fastener
- 8 point sockets are designed for quick engagement on 4 point fasteners



JHWSD-1224 JHWSD-1216



JHWSSD-11RC

Features

- SUPERTORQUE™ lobular openings for greater turning power without deforming the fastener
- Designed for quick engagement on both 6 and 12 point fasteners

1/2" DRIVE

SOCKETS AND DRIVE TOOLS





JHWS-624 JHWS-616

1/2" DRIVE DEEP SOCKETS, 6 POINT, SAE

High-Polished Chrome Finish

Product Code	Size (Inches)	A	B	C	D	E	F	
		OAL (Inches)	Drive End Diameter (Inches)	Working End Diameter (Inches)	Broach Depth (Inches)	Bolt Clearance Depth (Inches)	Bolt Clearance Diameter (Inches)	Nose Length (Inches)
JHWS-616	1/2	3 1/4	29/32	3/4	13/32	2 19/32	15/32	2 15/32
JHWS-618	9/16	3 1/4	29/32	13/16	7/16	2 19/32	15/32	2 15/32
JHWS-620	5/8	3 1/4	29/32	29/32	15/32	2 7/16	19/32	-
JHWS-622	1 1/16	3 1/4	31/32	31/32	17/32	2 11/32	21/32	-
JHWS-624	3/4	3 1/4	1 1/16	1 1/16	19/32	2 5/16	23/32	-
JHWS-626	13/16	3 1/4	1 1/8	1 1/8	21/32	2 9/32	25/32	-
JHWS-628	7/8	3 1/4	1 3/16	1 3/16	23/32	2 9/32	27/32	-
JHWS-630	15/16	3 1/4	1 9/32	1 9/32	3/4	2 9/32	29/32	-
JHWS-632	1	3 1/4	1 11/32	1 11/32	3/4	2 1/4	1	-
JHWS-634	1 1/16	3 1/4	1 7/16	1 7/16	25/32	2 1/4	1 1/32	-
JHWS-636	1 1/8	3 1/4	1 1/2	1 1/2	25/32	2 1/4	1 3/32	-

Fed. Spec: ANSI B107.110

JHWS-11HRC 11 Piece 1/2" Drive Deep 6 Point Socket Set on Clip Rail

Contents Include:

Product Code	Size (Inches)	Product Code	Size (Inches)	Product Code	Size (Inches)
JHWS-616	1/2	JHWS-624	3/4	JHWS-632	1
JHWS-618	9/16	JHWS-626	13/16	JHWS-634	1 1/16
JHWS-620	5/8	JHWS-628	7/8	JHWS-636	1 1/8
JHWS-622	1 1/16	JHWS-630	15/16		

Features

- SUPERTORQUE™ lobular openings for greater turning power without deforming the fastener
- Designed for maximum engagement on 6 point fasteners



JHWS-11HRC

1/2" DRIVE

SOCKETS AND DRIVE TOOLS

1/2" DRIVE SHALLOW SOCKETS, 12 POINT, METRIC



High-Polished Chrome Finish

Product Code	Size (MM)	A OAL (Inches)	B Drive End Diameter (Inches)	C Working End Diameter (Inches)	D Broach Depth (Inches)	E Bolt Clearance Depth (Inches)	F Bolt Clearance Diameter (Inches)	Nose Length (Inches)
JHWSTM-1210	10	1 1/2	29/32	19/32	5/16	7/8	1 1/32	23/32
JHWSTM-1211	11	1 1/2	29/32	11/16	5/16	7/8	13/32	23/32
JHWSTM-1212	12	1 1/2	29/32	23/32	13/32	7/8	7/16	23/32
JHWSTM-1213	13	1 1/2	29/32	25/32	3/8	7/8	15/32	23/32
JHWSTM-1214	14	1 1/2	29/32	27/32	3/8	7/8	15/32	23/32
JHWSTM-1215	15	1 1/2	29/32	7/8	3/8	7/8	15/32	-
JHWSTM-1216	16	1 1/2	29/32	29/32	9/16	7/8	15/32	-
JHWSTM-1217	17	1 1/2	31/32	31/32	9/16	7/8	15/32	-
JHWSTM-1218	18	1 1/2	1	1	13/16	27/32	15/32	-
JHWSTM-1219	19	1 1/2	1 1/32	1 1/32	13/16	27/32	23/32	-
JHWSTM-1220	20	1 1/2	1 1/16	1 1/16	13/16	27/32	23/32	-
JHWSTM-1221	21	1 1/2	1 1/8	1 1/8	13/16	27/32	3/4	-
JHWSTM-1222	22	1 1/2	1 3/16	1 3/16	13/16	27/32	25/32	-
JHWSTM-1223	23	1 1/2	1 1/4	1 1/4	29/32	13/16	27/32	-
JHWSTM-1224	24	1 17/32	1 9/32	1 9/32	13/16	27/32	7/8	-
JHWSTM-1225	25	1 9/16	1 3/16	1 5/16	13/16	7/8	15/16	-
JHWSTM-1226	26	1 5/8	1 3/8	1 3/8	29/32	15/16	31/32	-
JHWSTM-1227	27	1 23/32	1 7/16	1 7/16	31/32	1	1	-
JHWSTM-1228	28	1 3/4	1 1/2	1 1/2	1	1 1/16	1 1/32	-
JHWSTM-1229	29	1 3/4	1 9/16	1 9/16	1 1/32	1 1/16	1 1/16	-
JHWSTM-1230	30	1 3/4	1 5/8	1 5/8	1 1/32	1 5/32	1 5/32	-
JHWSTM-1232	32	1 7/8	1 11/16	1 11/16	1 1/8	1 5/32	1 3/16	-
JHWSTM-1234	34	2 1/16	1 3/4	1 3/4	7/8	1 7/16	1	-
JHWSTM-1236	36	2 1/16	1 15/16	1 15/16	7/8	1 7/16	1 13/32	-

Fed. Spec: ANSI B107.110

JHWSS-15RC 15 Piece 1/2" Drive Shallow 12 Point Socket Set on Clip Rail

Contents Include:

Product Code	Size (MM)	Product Code	Size (MM)	Product Code	Size (MM)	Product Code	Size (MM)
JHWSTM-1210	10	JHWSTM-1214	14	JHWSTM-1218	18	JHWSTM-1222	22
JHWSTM-1211	11	JHWSTM-1215	15	JHWSTM-1219	19	JHWSTM-1223	23
JHWSTM-1212	12	JHWSTM-1216	16	JHWSTM-1220	20	JHWSTM-1224	24
JHWSTM-1213	13	JHWSTM-1217	17	JHWSTM-1221	21		



JHWSTM-1229 JHWSTM-1212

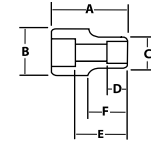

JHWSS-15RC

JHWSS-15SR 15 Piece 1/2" Drive Shallow 12 Point Socket Set on Clip Rail

Contents Include:

Product Code	Size (MM)	Product Code	Size (MM)	Product Code	Size (MM)	Product Code	Size (MM)
JHWSTM-1210	10	JHWSTM-1217	17	JHWSTM-1222	22	JHWSTM-1227	27
JHWSTM-1213	13	JHWSTM-1218	18	JHWSTM-1223	23	JHWSTM-1230	30
JHWSTM-1214	14	JHWSTM-1219	19	JHWSTM-1224	24	JHWSTM-1232	32
JHWSTM-1215	15	JHWSTM-1220	20	JHWSTM-1226	26		



JHWSS-15SRC

JHWSS-24RC 24 Piece 1/2" Drive Shallow 12 Point Socket Set on Clip Rail

Contents Include:

Product Code	Size (MM)	Product Code	Size (MM)	Product Code	Size (MM)	Product Code	Size (MM)
JHWSTM-1210	10	JHWSTM-1216	16	JHWSTM-1222	22	JHWSTM-1228	28
JHWSTM-1211	11	JHWSTM-1217	17	JHWSTM-1223	23	JHWSTM-1229	29
JHWSTM-1212	12	JHWSTM-1218	18	JHWSTM-1224	24	JHWSTM-1230	30
JHWSTM-1213	13	JHWSTM-1219	19	JHWSTM-1225	25	JHWSTM-1232	32
JHWSTM-1214	14	JHWSTM-1220	20	JHWSTM-1226	26	JHWSTM-1234	34
JHWSTM-1215	15	JHWSTM-1221	21	JHWSTM-1227	27	JHWSTM-1236	36

Features

- SUPERTORQUE™ lobular openings for greater turning power without deforming the fastener
- Designed for quick engagement on both 6 and 12 point fasteners



JHWSS-24RC



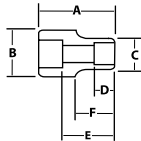

1/2" DRIVE SHALLOW SOCKETS, 6 POINT, METRIC

High-Polished Chrome Finish

Product Code	Size (MM)	A	B	C	D	E	F	
		OAL (Inches)	Drive End Diameter (Inches)	Working End Diameter (Inches)	Broach Depth (Inches)	Bolt Clearance Depth (Inches)	Bolt Clearance Diameter (Inches)	Nose Length (Inches)
JHW32509	9	1 1/2	7/8	9/16	9/16	1 1/16	5/16	23/32
JHW32510	10	1 1/2	7/8	5/8	1/2	21/32	3/8	23/32
JHW32511	11	1 1/2	7/8	21/32	1/2	7/8	13/32	23/32
JHW32512	12	1 1/2	7/8	23/32	1/2	7/8	7/16	23/32
JHW32513	13	1 1/2	7/8	3/4	9/16	21/32	15/32	23/32
JHW32514	14	1 1/2	7/8	19/16	9/16	19/16	11/32	23/32
JHW32515	15	1 1/2	7/8	7/8	17/32	19/16	9/16	-
JHW32516	16	1 1/2	29/32	29/32	17/32	21/32	19/32	-
JHW32517	17	1 1/2	19/16	19/16	17/32	21/32	17/32	-
JHW32518	18	1 1/2	1	1	3/4	13/16	11/16	-
JHW32519	19	1 1/2	1 1/16	1 1/16	3/4	7/8	49/64	-
JHW32520	20	1 1/2	1 3/32	1 3/32	29/32	15/16	47/64	-
JHW32521	21	1 1/2	1 1/8	1 1/8	25/32	15/16	49/64	-
JHW32522	22	1 5/8	1 3/16	1 3/16	7/8	1 1/32	29/32	-
JHW32523	23	1 5/8	1 7/32	1 7/32	7/8	1 1/32	13/16	-
JHW32524	24	1 5/8	1 1/4	1 1/4	7/8	1 3/32	53/64	-
JHW32525	25	1 5/8	1 5/16	1 5/16	7/8	1 3/32	55/64	-
JHW32526	26	1 3/4	1 5/16	1 5/16	15/16	1 3/16	51/64	-
JHW32527	27	1 3/4	1 7/16	1 7/16	15/16	1 3/16	29/32	-
JHW32528	28	1 3/4	1 7/16	1 7/16	31/32	1 9/32	15/16	-
JHW32529	29	1 3/4	1 1/2	1 1/2	31/32	1 9/32	31/32	-
JHW32530	30	1 3/4	1 9/16	1 9/16	31/32	1 11/32	69/64	-
JHW32532	32	1 31/32	1 11/16	1 31/32	1 1/8	1 1/2	1 1/32	-
JHW32534	34	1 47/64	1 1/2	1 49/64	31/32	1 11/32	1 1/64	-
JHW32536	36	2 1/16	1 15/16	1 15/16	7/8	1 7/16	1 13/32	-

Fed. Spec: ANSI B107.110



JHW32943

16 Piece 1/2" Drive Shallow 6 Point Socket Set on Clip Rail

Contents Include:

Product Code	Size (MM)	Product Code	Size (MM)	Product Code	Size (MM)	Product Code	Size (MM)
JHW32509	9	JHW32513	13	JHW32517	17	JHW32521	21
JHW32510	10	JHW32514	14	JHW32518	18	JHW32522	22
JHW32511	11	JHW32515	15	JHW32519	19	JHW32523	23
JHW32512	12	JHW32516	16	JHW32520	20	JHW32524	24



JHW32941

24 piece 1/2" Drive Shallow 6 Point Socket Set on Clip Rails

Contents Include:

Product Code	Size (MM)	Product Code	Size (MM)	Product Code	Size (MM)	Product Code	Size (MM)
JHW32509	9	JHW32515	15	JHW32521	21	JHW32527	27
JHW32510	10	JHW32516	16	JHW32522	22	JHW32528	28
JHW32511	11	JHW32517	17	JHW32523	23	JHW32529	29
JHW32512	12	JHW32518	18	JHW32524	24	JHW32530	30
JHW32513	13	JHW32519	19	JHW32525	25	JHW32532	32
JHW32514	14	JHW32520	20	JHW32526	26	JHW32536	36

Features

- SUPERTORQUE™ lobular openings for greater turning power without deforming the fastener
- Designed for quick engagement on both 6 point fasteners

1/2" DRIVE SOCKETS AND DRIVE TOOLS

1/2" DRIVE DEEP SOCKETS, 12 POINT, METRIC



High-Polished Chrome Finish

Product Code	Size (MM)	A	B	C	D	E	F
		OAL (Inches)	Drive End Diameter (Inches)	Working End Diameter (Inches)	Broach Depth (Inches)	Bolt Clearance Depth (Inches)	Bolt Clearance Diameter (Inches)
JHWSMD-1213	13	3 1/4	29/32	25/32	13/32	2 15/32	2 19/32
JHWSMD-1214	14	3 1/4	29/32	27/32	13/32	2 15/32	2 19/32
JHWSMD-1215	15	3 1/4	29/32	7/8	13/32	2 15/32	-
JHWSMD-1216	16	3 1/4	29/32	29/32	15/32	2 7/16	-
JHWSMD-1217	17	3 1/4	31/32	31/32	1/2	2 11/32	-
JHWSMD-1218	18	3 1/4	1	1	17/32	2 11/32	-
JHWSMD-1219	19	3 1/4	1 1/32	1 1/32	9/16	2 9/16	1 1/16
JHWSMD-1221	21	3 1/4	1 1/8	1 1/8	21/32	2 5/16	-
JHWSMD-1222	22	3 1/4	1 3/16	1 3/16	23/32	2 9/32	13/16
JHWSMD-1224	24	3 1/4	1 9/32	1 9/32	3/4	2 9/32	-
JHWSMD-1227	27	3 1/4	1 7/16	1 7/16	3/4	2 1/4	-
JHWSMD-1230	30	3 1/4	1 5/8	1 5/8	13/16	2 1/4	1 3/32

Fed. Spec: ANSI B107.110

JHWMSSD-12RC 12 Piece 1/2" Drive Deep 12 Point Socket Set on Clip Rail

Contents Include:

Product Code	Size (MM)	Product Code	Size (MM)	Product Code	Size (MM)
JHWSMD-1213	13	JHWSMD-1217	17	JHWSMD-1222	22
JHWSMD-1214	14	JHWSMD-1218	18	JHWSMD-1224	24
JHWSMD-1215	15	JHWSMD-1219	19	JHWSMD-1227	27
JHWSMD-1216	16	JHWSMD-1221	21	JHWSMD-1230	30

Features

- SUPERTORQUE™ lobular openings for greater turning power without deforming the fastener
- Designed for quick engagement on both 6 and 12 point fasteners



Made in U.S.A.



JHWSMD-1218

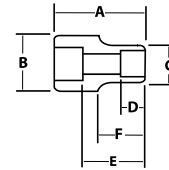

JHWMSSD-12RC





1/2" DRIVE DEEP SOCKETS, 6 POINT, METRIC

High-Polished Chrome Finish



JHW32717 JHW32710

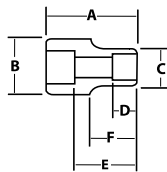

Product Code	Size (MM)	A	B	C	D	E	F
		OAL (Inches)	Drive End Diameter (Inches)	Working End Diameter (Inches)	Broach Depth (Inches)	Bolt Clearance Depth (Inches)	Bolt Clearance Diameter (Inches)
JHW32709	9	3 1/4	29/32	19/32	5/16	2 15/32	2 19/32
JHW32710	10	3 1/4	29/32	19/32	5/16	2 15/32	2 19/32
JHW32711	11	3 1/4	29/32	1 1/16	5/16	2 15/32	2 19/32
JHW32712	12	3 1/4	29/32	23/32	13/32	2 15/32	2 19/32
JHW32713	13	3 1/4	29/32	25/32	3/8	2 15/32	2 19/32
JHW32714	14	3 1/4	29/32	27/32	3/8	2 15/32	2 19/32
JHW32715	15	3 1/4	29/32	7/8	3/8	2 1 1/32	19/32
JHW32716	16	3 1/4	29/32	29/32	9/16	2 1 1/32	15/32
JHW32717	17	3 1/4	31/32	31/32	9/16	2 1 1/32	19/32
JHW32718	18	3 1/4	1	1	13/16	2 1 1/32	15/32
JHW32719	19	3 1/4	1 1/32	1 1/32	13/16	2 5/16	29/32
JHW32720	20	3 1/4	1 1/16	1 1/16	13/16	2 5/16	29/32
JHW32721	21	3 1/4	1 1/8	1 1/8	13/16	2 5/16	3/4
JHW32722	22	3 1/4	1 9/16	1 9/16	13/16	2 5/16	29/32
JHW32723	23	3 1/4	1 1/4	1 1/4	25/32	2 5/16	2 1/32
JHW32724	24	3 1/4	1 9/32	1 9/32	13/16	2 5/16	7/8
JHW32725	25	3 1/4	1 5/16	1 5/16	13/16	2 1/4	19/32
JHW32726	26	3 1/4	1 3/8	1 3/8	29/32	2 1/4	31/32
JHW32727	27	3 1/4	1 7/16	1 7/16	31/32	2 1/4	1
JHW32728	28	3 1/4	1 1/2	1 1/2	1	2 1/4	1 1/32
JHW32729	29	3 1/4	1 9/16	1 9/16	1 1/32	2 1/4	1 1/16
JHW32730	30	3 1/4	1 5/8	1 5/8	1 1/32	2 1/4	1 3/32
JHW32732	32	3 1/4	1 11/16	1 11/16	1 1/8	2 1/4	1 3/16
JHW32734	34	3 1/4	1 3/4	1 3/4	7/8	2 1/4	1
JHW32736	36	3 1/4	1 15/16	1 15/16	7/8	2 1/4	1 13/32

Fed. Spec: ANSI B107.110



JHW32947

JHW32947 16 Piece 1/2" Drive Deep 6 Point Socket Set on Clip Rail

Contents Include:

Product Code	Size (MM)	Product Code	Size (MM)	Product Code	Size (MM)	Product Code	Size (MM)
JHW32709	9	JHW32713	13	JHW32717	17	JHW32721	21
JHW32710	10	JHW32714	14	JHW32718	18	JHW32722	22
JHW32711	11	JHW32715	15	JHW32719	19	JHW32723	23
JHW32712	12	JHW32716	16	JHW32720	20	JHW32724	24



JHW32945

JHW32945 24 Piece 1/2" Drive Deep 6 Point Socket Set on Clip Rail

Contents Include:

Product Code	Size (MM)	Product Code	Size (MM)	Product Code	Size (MM)	Product Code	Size (MM)
JHW32709	9	JHW32715	15	JHW32721	21	JHW32727	27
JHW32710	10	JHW32716	16	JHW32722	22	JHW32728	28
JHW32711	11	JHW32717	17	JHW32723	23	JHW32729	29
JHW32712	12	JHW32718	18	JHW32724	24	JHW32730	30
JHW32713	13	JHW32719	19	JHW32725	25	JHW32732	32
JHW32714	14	JHW32720	20	JHW32726	26	JHW32736	36

Features

- SUPERTORQUE™ lobular openings for greater turning power without deforming the fastener
- Designed for quick engagement on both 6 and 12 point fasteners

1/2" DRIVE

SOCKETS AND DRIVE TOOLS

1/2" DRIVE TURBOSOCKET® SALVAGE/ DAMAGED FASTENER SOCKETS



Black Industrial Finish, Metric and SAE

Product Code	Size (Inches)	A		B		C		D		E		F	
		OAL (Inches)	Drive End Diameter (Inches)	Working End Diameter (Inches)	Broach Depth (Inches)	Bolt Clearance Depth (Inches)	Bolt Clearance Diameter (Inches)	Nose Length (Inches)					
JHWTS50750	3/4	1 21/32	1 1/16	1 1/16	23/32	1	3/4	-					
JHWTS50812	13/16	1 21/32	1 1/8	1 1/8	23/32	1	13/16	-					
JHWTS50875	7/8	1 21/32	1 3/16	1 3/16	23/32	1	7/8	-					
JHWTS50937	15/16	1 21/32	1 5/16	1 5/16	23/32	1	15/16	-					
JHWTS50100	1	1 21/32	1 11/32	1 11/32	23/32	1	1	-					

Product Code	Size (MM)	A		B		C		D		E		F	
		OAL (Inches)	Drive End Diameter (Inches)	Working End Diameter (Inches)	Broach Depth (Inches)	Bolt Clearance Depth (Inches)	Bolt Clearance Diameter (Inches)	Nose Length (Inches)					
JHWTS51551	14	1 21/32	29/32	27/32	1/2	1	9/16	29/32					
JHWTS51591	15	1 21/32	29/32	29/32	1/2	1	19/32	-					
JHWTS51625	16	1 21/32	31/32	31/32	1/2	23/32	5/8	-					
JHWTS51669	17	1 21/32	1	1	21/32	23/32	11/16	-					
JHWTS51709	18	1 21/32	1 1/32	1 1/32	21/32	23/32	23/32	-					
JHWTS51750	19	1 21/32	1 1/16	1 1/16	23/32	1	3/4	-					
JHWTS51827	21	1 21/32	1 3/16	1 3/16	21/32	1	27/32	-					

JHWTSFS5005 5 Piece TURBOSOCKET® Salvage Socket Set on Clip Rail, SAE Contents Include:

Product Code	Size (Inches)	Product Code	Size (Inches)
JHWTS50750	3/4	JHWTS50937	15/16
JHWTS50812	13/16	JHWTS50100	1
JHWTS50875	7/8		

JHWTSMS5107 7 Piece TURBOSOCKET® Salvage Socket Set on Clip Rail, Metric Contents Include:

Product Code	Size (MM)	Product Code	Size (MM)
JHWTS51551	14	JHWTS51709	18
JHWTS51591	15	JHWTS51750	19 (3/4")
JHWTS51625	16 (5/8")	JHWTS51827	21
JHWTS51669	17		

Features

- Quickly and easily remove damaged or rounded nuts and bolts
- Place socket on fastener and turn with ratchet, breaker bar or T-handle
- Grip on fastener tightens as more torque is applied
- No hammering is required to install socket over fastener
- Use on all types of standard nuts and bolts as well as studs, pipe nipples, and corroded auto and marine fasteners
- May be used for "best fit" on metric and fractional fasteners
- May be used with air or electric impact wrench for extra speed and turning power



JHWTS50750



JHWTS51551



JHWTSFS5005



JHWTSMS5107

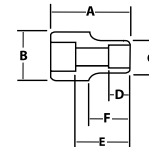

1/2" DRIVE

SOCKETS AND
DRIVE TOOLS





JHWSA-16LA

JHWWSS-6LRC

1/2" DRIVE LONG HEX BIT SOCKETS, SAE



High-Polished Chrome Finish

Product Code	Size (Inches)	Socket Length (Inches)	Socket Outside Diameter (Inches)	Overall Length (Inches)	Replacement Bit Product Code
JHWSA-8LA	1/4	1 1/2	29/32	4 1/2	JHWBITH0806
JHWSA-10LA	5/16	1 1/2	29/32	4 1/2	JHWBITH1006
JHWSA-12LA	3/8	1 1/2	29/32	4 1/2	JHWBITH1204
JHWSA-16LA	1/2	1 1/2	31/32	4 1/2	JHWBITH1602
JHWSA-18LA	9/16	1 9/16	1 1/16	4 1/2	JHWBITH1802
JHWSA-20LA	5/8	1 25/32	1 1/4	4 1/2	JHWBITH2002

JHWWSS-6LRC 6 Piece Long Hex Bit Socket Set on Clip Rail

Contents Include:

Product Code	Size (Inches)	Product Code	Size (Inches)
JHWSA-8LA	1/4	JHWSA-16LA	1/2
JHWSA-10LA	5/16	JHWSA-18LA	9/16
JHWSA-12LA	3/8	JHWSA-20LA	5/8

Features

- High-polished chrome finish socket cleans easily
- Two piece design allows bits to be replaced easily



1/2" DRIVE STANDARD LENGTH HEX BIT SOCKETS, SAE



High-Polished Chrome Finish

Product Code	Size (Inches)	Socket Length (Inches)	Socket Outside Diameter (Inches)	Overall Length (Inches)	Replacement Bit Product Code
JHWSA-8A	1/4	1 1/2	29/32	2 1/4	JHWBITH0805
JHWSA-10A	5/16	1 1/2	29/32	2 1/4	JHWBITH1005
JHWSA-12A	3/8	1 1/2	29/32	2 1/4	JHWBITH1203
JHWSA-16A	1/2	1 1/2	31/32	2 1/4	JHWBITH1601
JHWSA-18A	9/16	1 9/16	1 1/16	2 1/4	JHWBITH1801
JHWSA-20A	5/8	1 25/32	1 1/4	2 1/4	JHWBITH2001

JHWWSS-6RC 6 Piece Hex Bit Socket Set on Clip Rail

Contents Include:

Product Code	Size (Inches)	Product Code	Size (Inches)
JHWSA-8A	1/4	JHWSA-16A	1/2
JHWSA-10A	5/16	JHWSA-18A	9/16
JHWSA-12A	3/8	JHWSA-20A	5/8

Features

- High-polished chrome finish socket cleans easily
- Two piece design allows bits to be replaced easily



JHWSA-16A

JHWWSS-6RC

1/2" DRIVE STANDARD LENGTH HEX BIT SOCKETS, METRIC



High-Polished Chrome Finish

Product Code	Size (MM)	Socket Length (Inches)	Socket Outside Diameter (Inches)	Overall Length (Inches)	Bit Length (Inches)
JHW35274	8	1 19/32	29/32	2 19/32	27/32
JHW35275	10	1 19/32	29/32	2 7/16	27/32
JHW35276	12	1 19/32	29/32	2 7/16	27/32
JHW35277	14	1 19/32	1	2 7/16	27/32
JHW35278	17	1 19/32	1 3/32	2 7/16	27/32
JHW35279	19	1 19/32	1 9/16	2 7/16	27/32

JHW32904 6 Piece Hex Bit Socket Set on Clip Rail

Contents Include:

Product Code	Size (MM)	Product Code	Size (MM)
JHW35274	8	JHW35277	14
JHW35275	10	JHW35278	17
JHW35276	12	JHW35279	19

Features

- High-polished chrome finish socket cleans easily



JHW35274

JHW32904

1/2" DRIVE SOCKETS AND DRIVE TOOLS

1/2" DRIVE LONG LENGTH HEX BIT SOCKETS, METRIC



High-Polished Chrome Finish

Product Code	Size (MM)	Socket Length (Inches)	Socket Outside Diameter (Inches)	Overall Length (Inches)
JHW35294	8	1 1/2	29/32	5 1/2
JHW35295	10	1 1/2	29/32	5 1/2
JHW35296	12	1 1/2	29/32	5 1/2
JHW35297	14	1 1/2	1	5 1/2
JHW35298	17	1 1/2	1 3/32	5 1/2
JHW35299	19	1 1/2	1 3/16	5 1/2

JHW32953 6 Piece Hex Bit Socket Set on Clip Rail

Contents Include:

Product Code	Size (MM)	Product Code	Size (MM)
JHW35294	8	JHW35297	14
JHW35295	10	JHW35298	17
JHW35296	12	JHW35299	19

Features

- High-polished chrome finish socket cleans easily



1/2" DRIVE TORX® BIT SOCKETS



High-Polished Chrome Finish

Product Code	Torx® Size	Socket Length (Inches)	Socket Outside Diameter (Inches)	Overall Length (Inches)	Bit Length (Inches)
JHW35283	T40	1 19/32	29/32	2 7/16	7/8
JHW35284	T45	1 19/32	29/32	2 7/16	7/8
JHW35285	T50	1 19/32	29/32	2 7/16	7/8
JHW35286	T55	1 19/32	29/32	2 7/16	7/8
JHW35287	T60	1 19/32	29/32	2 7/16	7/8

JHW32908 5 Piece Torx® Bit Socket Set on Clip Rail

Contents Include:

Product Code	Torx® Size	Product Code	Torx® Size
JHW35283	T40	JHW35286	T55
JHW35284	T45	JHW35287	T60
JHW35285	T50		

Features

- High-polished chrome finish socket cleans easily



1/2" DRIVE SCREWDRIVER BIT SOCKETS



High-Polished Chrome Finish, Phillips® and Slotted

Product Code	Size (Inches) / Socket Length		Socket Outside Diameter (Inches)	Overall Length (Inches)	Replacement Bit Product Code
	Point Size	(Inches)			
Slotted Bits:					
JHWSA-10A-3S	23/64 x .061	1 1/2	29/32	2 9/32	JHWBITHS03
JHWSA-12A-4S	27/64 x .075	1 1/2	29/32	2 1/4	JHWBITHS04
Phillips® Bits:					
JHWSA-10A-3P	#3	1 1/2	29/32	2 1/4	JHWBITPH0302
JHWSA-12A-4P	#4	1 1/2	29/32	2 1/4	JHWBITPH0401

JHWWSSSP-4RC 4 Piece Screwdriver Bit Socket Set on Clip Rail

Contents Include:

Product Code	Tip Size	Product Code	Tip Size
JHWSA-10A-3S	23/64 x .061	JHWSA-10A-3P	3
JHWSA-12A-4S	27/64 x .075	JHWSA-12A-4P	4

Features

- High-polished chrome finish socket cleans easily
- Two piece design allows bits to be replaced easily



JHWSA-10A-3P

JHWSA-10A-3S



JHWWSSSP-4RC

1/2" DRIVE

SOCKETS AND
DRIVE TOOLS



Made in U.S.A.





JHW35251



JHW32906

1/2" DRIVE PHILLIPS® SCREWDRIVER BIT SOCKETS



High-Polished Chrome Finish

Product Code	Tip Size	Socket Length (Inches)	Socket Outside Diameter (Inches)	Overall Length (Inches)	Bit Length (Inches)
JHW35251	#2	1 19/32	29/32	2 7/16	7/8
JHW35252	#3	1 19/32	29/32	2 7/16	7/8
JHW35253	#4	1 19/32	29/32	2 7/16	7/8

JHW32906 3 Piece Phillips® Screwdriver Bit Socket Set on Clip Rail

Contents Include:

Product Code	Tip Size
JHW35251	#2
JHW35252	#3
JHW35253	#4

Features

- High-polished chrome finish socket cleans easily



JHWSB-30

1/2" DRIVE DRAG LINK SOCKETS



High-Polished Chrome Finish

Product Code	Overall Length (Inches)	Tip Thickness (Inches)	Tip Width (Inches)
JHWSB-30	1 5/8	5/32	15/16
JHWSB-40	1 11/16	5/32	1 3/16

Fed. Spec: ANSI B107.1

Features

- Ideal for drag links on trucks and heavy equipment, as well as large screws



Made in U.S.A.



JHWSB-526

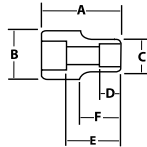

1/2" DRIVE 5 POINT PENTA-SOCKET



Black Industrial Finish

Product Code	Size (Inches)	A		B		C		D		E		F	
		OAL (Inches)	Drive End Diameter (Inches)	Working End Diameter (Inches)	Broach Depth (Inches)	Bolt Clearance Depth (Inches)	Bolt Clearance Diameter (Inches)	Nose Length (Inches)					
JHWSB-526	5/16	1 1/4	1 1/8	1 1/8	7/16	1/2	23/32	-					

Features

- 5 point Penta-Socket services 5 point nuts found on tamper-resistant Buffalo covers used by gas, electric, and some water companies to protect shutoff gates



Made in U.S.A.



JHW4A-620 with Retaining Ring 4-1XS



JHW4A-620

1/2" DRIVE HEX DRIVERS



High-Polished Chrome Finish

Product Code	Size	Overall Length (Inches)	Product Code Bits	Optional Ret Ring
JHW4A-620	5/8	3 1/2	JHW4A-620-2	4-1XS
JHW4A-622	11/16	3 1/2	JHW4A-622-2	4-1XS
JHW4A-624	3/4	3 1/2	JHW4A-624-2	4-1XS
JHW4A-628	7/8	3 1/2	JHW4A-628-2	4-1XS

Features

- Designed for use with pneumatic or cordless impact guns
- Optional retaining ring ensures positive attachment to anvil
- Manufactured from special alloy steel and heat treated for optimum strength and durability
- Williams® bits are designed with a precise fit and tight tolerances to prevent slippage and disengagement
- Outperforms one-piece design models – our two-piece design makes replacement economical and convenient
- Bits can be easily replaced by hand - no need to put them in a vice and punch them out with a hammer
- Optional retaining rings available for added protection

1/2" DRIVE SOCKET FLEXTENSIONS

Williams Flexextension are used extensively in engine and heavy equipment manufacturing, assembly and repair. They increase productivity by featuring an integrated (non-removable) design of the drive extension and socket to allow for reliable, continuous work without concern for the socket disconnecting from the extension as could happen with hand-tool type ball retained sockets.

See page 252 for 3/8" Drive Socket Flexextensions.

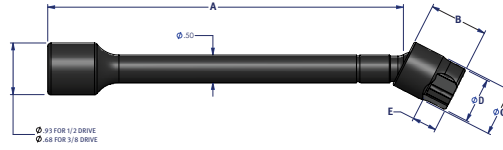

1/2" DRIVE SOCKET FLEXTENSIONS, SAE

Black Industrial Finish

Product Code	Drive	A Shank Length	Tension	Socket Points	Socket	B Socket Length	C Socket Diameter	D Nose Diameter	E Hex Depth
JHWISSXT312	1/2"	3.02"/76.7MM	Yes	6	3/8"	1.06"/26.9MM	0.90"/22.7MM	0.63"/16.0MM	0.28"/7.1MM
JHWISSX312	1/2"	3.02"/76.7MM	No	6	3/8"	1.06"/26.9MM	0.90"/22.7MM	0.63"/16.0MM	0.28"/7.1MM
JHWISSXT412	1/2"	4.09"/103.9MM	Yes	6	3/8"	1.06"/26.9MM	0.90"/22.7MM	0.63"/16.0MM	0.28"/7.1MM
JHWISSX412	1/2"	4.09"/103.9MM	No	6	3/8"	1.06"/26.9MM	0.90"/22.7MM	0.63"/16.0MM	0.28"/7.1MM
JHWISSX612	1/2"	6.57"/166.9MM	No	6	3/8"	1.06"/26.9MM	0.90"/22.7MM	0.63"/16.0MM	0.28"/7.1MM
JHWISSXT912	1/2"	9.57"/243.1MM	Yes	6	3/8"	1.06"/26.9MM	0.90"/22.7MM	0.63"/16.0MM	0.28"/7.1MM
JHWISSX912	1/2"	9.57"/243.1MM	No	6	3/8"	1.06"/26.9MM	0.90"/22.7MM	0.63"/16.0MM	0.28"/7.1MM
JHWISSXT314	1/2"	3.02"/76.7MM	Yes	6	7/16"	1.06"/26.9MM	0.90"/22.7MM	0.76"/19.3MM	0.3"/7.6MM
JHWISSX314	1/2"	3.02"/76.7MM	No	6	7/16"	1.06"/26.9MM	0.90"/22.7MM	0.76"/19.3MM	0.3"/7.6MM
JHWISSXT414	1/2"	4.09"/103.9MM	Yes	6	7/16"	1.06"/26.9MM	0.90"/22.7MM	0.76"/19.3MM	0.3"/7.6MM
JHWISSX414	1/2"	4.09"/103.9MM	No	6	7/16"	1.06"/26.9MM	0.90"/22.7MM	0.76"/19.3MM	0.3"/7.6MM
JHWISSXT614	1/2"	6.57"/166.9MM	Yes	6	7/16"	1.06"/26.9MM	0.90"/22.7MM	0.76"/19.3MM	0.3"/7.6MM
JHWISSX614	1/2"	6.57"/166.9MM	No	6	7/16"	1.06"/26.9MM	0.90"/22.7MM	0.76"/19.3MM	0.3"/7.6MM
JHWISSXT914	1/2"	9.57"/243.1MM	Yes	6	7/16"	1.06"/26.9MM	0.90"/22.7MM	0.76"/19.3MM	0.3"/7.6MM
JHWISSX914	1/2"	9.57"/243.1MM	No	6	7/16"	1.06"/26.9MM	0.90"/22.7MM	0.76"/19.3MM	0.3"/7.6MM
JHWISSXT316	1/2"	3.02"/76.7MM	Yes	6	1/2"	1.06"/26.9MM	0.90"/22.7MM	0.76"/19.3MM	0.34"/8.6MM
JHWISSX316	1/2"	3.02"/76.7MM	No	6	1/2"	1.06"/26.9MM	0.90"/22.7MM	0.76"/19.3MM	0.34"/8.6MM
JHWISSXT416	1/2"	4.09"/103.9MM	Yes	6	1/2"	1.06"/26.9MM	0.90"/22.7MM	0.76"/19.3MM	0.34"/8.6MM
JHWISSX416	1/2"	4.09"/103.9MM	No	6	1/2"	1.06"/26.9MM	0.90"/22.7MM	0.76"/19.3MM	0.34"/8.6MM
JHWISSXT616	1/2"	6.57"/166.9MM	Yes	6	1/2"	1.06"/26.9MM	0.90"/22.7MM	0.76"/19.3MM	0.34"/8.6MM
JHWISSX616	1/2"	6.57"/166.9MM	No	6	1/2"	1.06"/26.9MM	0.90"/22.7MM	0.76"/19.3MM	0.34"/8.6MM
JHWISSXT916	1/2"	9.57"/243.1MM	Yes	6	1/2"	1.06"/26.9MM	0.90"/22.7MM	0.76"/19.3MM	0.34"/8.6MM
JHWISSX916	1/2"	9.57"/243.1MM	No	6	1/2"	1.06"/26.9MM	0.90"/22.7MM	0.76"/19.3MM	0.34"/8.6MM
JHWISSXT418	1/2"	4.09"/103.9MM	Yes	6	9/16"	1.06"/26.9MM	0.90"/22.7MM	0.82"/20.8MM	0.44"/11.2MM
JHWISSX418	1/2"	4.09"/103.9MM	No	6	9/16"	1.06"/26.9MM	0.90"/22.7MM	0.82"/20.8MM	0.44"/11.2MM
JHWSPSXTL618	1/2"	6.57"/166.9MM	Yes	6	9/16"	0.78"/19.8MM	0.90"/22.7MM	0.76"/19.4MM	0.16"/4.1MM
JHWSPSXL618	1/2"	6.57"/166.9MM	No	6	9/16"	0.78"/19.8MM	0.90"/22.7MM	0.76"/19.4MM	0.16"/4.1MM
JHWISSXT618	1/2"	6.57"/166.9MM	Yes	6	9/16"	1.06"/26.9MM	0.90"/22.7MM	0.82"/20.8MM	0.44"/11.2MM
JHWISSX618	1/2"	6.57"/166.9MM	No	6	9/16"	1.06"/26.9MM	0.90"/22.7MM	0.82"/20.8MM	0.44"/11.2MM
JHWISSXT918	1/2"	9.57"/243.1MM	Yes	6	9/16"	1.06"/26.9MM	0.90"/22.7MM	0.82"/20.8MM	0.44"/11.2MM
JHWISSX918	1/2"	9.57"/243.1MM	No	6	9/16"	1.06"/26.9MM	0.90"/22.7MM	0.82"/20.8MM	0.44"/11.2MM
JHWISSXT1218	1/2"	12.57"/319.3MM	Yes	6	9/16"	1.06"/26.9MM	0.90"/22.7MM	0.82"/20.8MM	0.44"/11.2MM
JHWISSX1218	1/2"	12.57"/319.3MM	No	6	9/16"	1.06"/26.9MM	0.90"/22.7MM	0.82"/20.8MM	0.44"/11.2MM
JHWISSXT320	1/2"	3.02"/76.7MM	Yes	6	5/8"	1.06"/26.9MM	0.90"/22.7MM	0.90"/22.7MM	0.44"/11.2MM
JHWISSX320	1/2"	3.02"/76.7MM	No	6	5/8"	1.06"/26.9MM	0.90"/22.7MM	0.90"/22.7MM	0.44"/11.2MM
JHWISSXT420	1/2"	4.09"/103.9MM	Yes	6	5/8"	1.06"/26.9MM	0.90"/22.7MM	0.90"/22.7MM	0.44"/11.2MM
JHWISSX420	1/2"	4.09"/103.9MM	No	6	5/8"	1.06"/26.9MM	0.90"/22.7MM	0.90"/22.7MM	0.44"/11.2MM
JHWISSXT620	1/2"	6.57"/166.9MM	Yes	6	5/8"	1.06"/26.9MM	0.90"/22.7MM	0.90"/22.7MM	0.44"/11.2MM
JHWISSX620	1/2"	6.57"/166.9MM	No	6	5/8"	1.06"/26.9MM	0.90"/22.7MM	0.90"/22.7MM	0.44"/11.2MM
ISSX620SOC75	1/2"	6.57"/166.9MM	No	6	5/8"	0.97"/24.7MM	0.90"/22.7MM	0.90"/22.7MM	0.35"/8.9MM
JHWISSXT920	1/2"	9.57"/243.1MM	Yes	6	5/8"	1.06"/26.9MM	0.90"/22.7MM	0.90"/22.7MM	0.44"/11.2MM
JHWISSX920	1/2"	9.57"/243.1MM	No	6	5/8"	1.06"/26.9MM	0.90"/22.7MM	0.90"/22.7MM	0.44"/11.2MM
JHWISSXT324	1/2"	3.02"/76.7MM	Yes	6	3/4"	1.25"/31.8MM	1.00"/25.4MM	1.12"/28.4MM	0.56"/14.2MM
JHWISSX324	1/2"	3.02"/76.7MM	No	6	3/4"	1.25"/31.8MM	1.00"/25.4MM	1.12"/28.4MM	0.56"/14.2MM

1/2" DRIVE

SOCKETS AND
DRIVE TOOLS

1/2" DRIVE SOCKET FLEXTENSIONS

Williams Flexextension are used extensively in engine and heavy equipment manufacturing, assembly and repair. They increase productivity by featuring an integrated (non-removable) design of the drive extension and socket to allow for reliable, continuous work without concern for the socket disconnecting from the extension as could happen with hand-tool type ball retained sockets.

See page 252 for 3/8" Drive Socket Flexextensions.

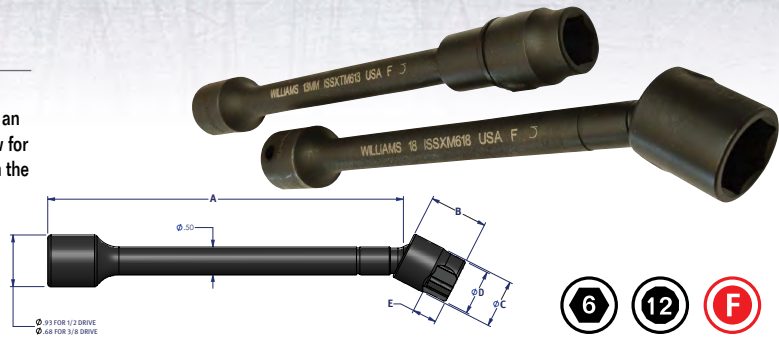

1/2" DRIVE SOCKET FLEXTENSIONS, SAE

Black Industrial Finish

Product Code	Drive	A Shank Length	Tension	Socket Points	Socket	B Socket Length	C Socket Diameter	D Nose Diameter	E Hex Depth
JHWISSXT424	1/2"	4.09"/103.9MM	Yes	6	3/4	1.25"/31.8MM	1.00"/25.4MM	1.12"/28.4MM	0.56"/14.2MM
JHWISSX424	1/2"	4.09"/103.9MM	No	6	3/4	1.25"/31.8MM	1.00"/25.4MM	1.12"/28.4MM	0.56"/14.2MM
JHWISSXT624	1/2"	6.57"/166.9MM	Yes	6	3/4	1.25"/31.8MM	1.00"/25.4MM	1.12"/28.4MM	0.56"/14.2MM
JHWISSX624	1/2"	6.57"/166.9MM	No	6	3/4	1.25"/31.8MM	1.00"/25.4MM	1.12"/28.4MM	0.56"/14.2MM
JHWISSX624MD	1/2"	6.57"/166.9MM	No	6	3/4	0.85"/21.6MM	1.00"/25.4MM	1.12"/28.4MM	0.31"/7.9MM
JHWISDX624LD	1/2"	6.57"/166.9MM	No	12	3/4	0.85"/21.6MM	1.00"/25.4MM	1.00"/25.4MM	0.31"/7.9MM
JHWISSXT924	1/2"	9.57"/243.1MM	Yes	6	3/4	1.25"/31.8MM	1.00"/25.4MM	1.12"/28.4MM	0.56"/14.2MM
JHWISSX924	1/2"	9.57"/243.1MM	No	6	3/4	1.25"/31.8MM	1.00"/25.4MM	1.12"/28.4MM	0.56"/14.2MM
JHWISSXT430	1/2"	4.09"/103.9MM	Yes	6	15/16	1.31"/33.3MM	1.00"/25.4MM	1.30"/33.0MM	0.62"/15.7MM
JHWISSX430	1/2"	4.09"/103.9MM	No	6	15/16	1.31"/33.3MM	1.00"/25.4MM	1.30"/33.0MM	0.62"/15.7MM
JHWISSXT630	1/2"	6.57"/166.9MM	Yes	6	15/16	1.31"/33.3MM	1.00"/25.4MM	1.30"/33.0MM	0.62"/15.7MM
JHWISSX630	1/2"	6.57"/166.9MM	No	6	15/16	1.31"/33.3MM	1.00"/25.4MM	1.30"/33.0MM	0.62"/15.7MM
JHWISSXT930	1/2"	9.57"/243.1MM	Yes	6	15/16	1.31"/33.3MM	1.00"/25.4MM	1.30"/33.0MM	0.62"/15.7MM
JHWISSX930	1/2"	9.57"/243.1MM	No	6	15/16	1.31"/33.3MM	1.00"/25.4MM	1.30"/33.0MM	0.62"/15.7MM
JHWISSXT1230	1/2"	12.57"/319.3MM	Yes	6	15/16	1.31"/33.3MM	1.00"/25.4MM	1.30"/33.0MM	0.62"/15.7MM
JHWISSX1230	1/2"	12.57"/319.3MM	No	6	15/16	1.31"/33.3MM	1.00"/25.4MM	1.30"/33.0MM	0.62"/15.7MM



1/2" DRIVE SOCKET FLEXTENSIONS, METRIC

Black Industrial Finish

Product Code	Drive	A Shank Length	Tension	Socket Points	Socket (mm)	B Socket Length	C Socket Diameter	D Nose Diameter	E Socket Hex Depth
JHWISSXTM410	1/2"	4.09"/103.9MM	Yes	6	10	1.06"/26.9MM	0.90"/22.7MM	0.63"/16.0MM	0.28"/7.1MM
JHWISSXM410	1/2"	4.09"/103.9MM	No	6	10	1.06"/26.9MM	0.90"/22.7MM	0.63"/16.0MM	0.28"/7.1MM
ISSXTMD610	1/2"	6.57"/166.9MM	Yes	12	10	1.30"/33.0MM	0.90"/22.7MM	0.59"/15.0MM	0.31"/7.9MM
JHWISSXM610	1/2"	6.57"/166.9MM	No	6	10	1.06"/26.9MM	0.90"/22.7MM	0.63"/16.0MM	0.28"/7.1MM
JHWISSXTM910	1/2"	9.57"/243.1MM	Yes	6	10	1.06"/26.9MM	0.90"/22.7MM	0.63"/16.0MM	0.28"/7.1MM
JHWISSXM910	1/2"	9.57"/243.1MM	No	6	10	1.06"/26.9MM	0.90"/22.7MM	0.63"/16.0MM	0.28"/7.1MM
JHWISSXTM412	1/2"	4.09"/103.9MM	Yes	6	12	1.06"/26.9MM	0.90"/22.7MM	0.76"/19.3MM	0.34"/8.6MM
JHWISSXM412	1/2"	4.09"/103.9MM	No	6	12	1.06"/26.9MM	0.90"/22.7MM	0.76"/19.3MM	0.34"/8.6MM
JHWISSXTM612	1/2"	6.57"/166.9MM	Yes	6	12	1.06"/26.9MM	0.90"/22.7MM	0.76"/19.3MM	0.34"/8.6MM
JHWISSXM612	1/2"	6.57"/166.9MM	No	6	12	1.06"/26.9MM	0.90"/22.7MM	0.76"/19.3MM	0.34"/8.6MM
JHWISSXTM912	1/2"	9.57"/243.1MM	Yes	6	12	1.06"/26.9MM	0.90"/22.7MM	0.76"/19.3MM	0.34"/8.6MM
JHWISSXM912	1/2"	9.57"/243.1MM	No	6	12	1.06"/26.9MM	0.90"/22.7MM	0.76"/19.3MM	0.34"/8.6MM
JHWISSXTM413	1/2"	4.09"/103.9MM	Yes	6	13	1.06"/26.9MM	0.90"/22.7MM	0.76"/19.3MM	0.34"/8.6MM
JHWISSXM413	1/2"	4.09"/103.9MM	No	6	13	1.06"/26.9MM	0.90"/22.7MM	0.76"/19.3MM	0.34"/8.6MM
JHWISSXTM613	1/2"	6.57"/166.9MM	Yes	6	13	1.06"/26.9MM	0.90"/22.7MM	0.76"/19.3MM	0.34"/8.6MM
JHWISSXM613	1/2"	6.57"/166.9MM	No	6	13	1.06"/26.9MM	0.90"/22.7MM	0.76"/19.3MM	0.34"/8.6MM

Features

- Made in the U.S.A.
- Durable black oxide finish.
- Socket retention pin is TIG welded, providing full rotation power to the socket
- Sockets feature SUPERTORQUE™ lobular openings for greater turning power without deforming the fastener
- Drive end has a 7/32" cross hole & bevel for ease of use
- Up to 30 degree angle offset
- Flexextensions are designed for use on hand and power tools (Impulse or Direct drive); NOT FOR IMPACT TOOL USE
- Maximum working torque values: 160 Ft. Lbs. /1920 In. Lbs. /217 Nm
- Other lengths and socket sizes available by special order. Contact your Williams representative



1/2" DRIVE
SOCKETS AND
DRIVE TOOLS

1/2" DRIVE SOCKET FLEXTENSIONS

Williams Flexextension are used extensively in engine and heavy equipment manufacturing, assembly and repair. They increase productivity by featuring an integrated (non-removable) design of the drive extension and socket to allow for reliable, continuous work without concern for the socket disconnecting from the extension as could happen with hand-tool type ball retained sockets.

See page 252 for 3/8" Drive Socket Flexextensions.

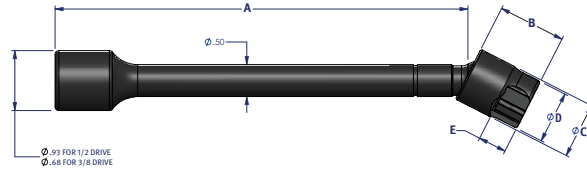

1/2" DRIVE SOCKET FLEXTENSION, METRIC

Black Industrial Finish

Product Code	Drive	A			B		C	D		E
		Shank Length	Tension	Socket Points	Socket (mm)	Socket Length	Socket Diameter	Socket Nose Diameter	Socket Hex Depth	
JHWISSXTM913	1/2"	9.57"/243.1MM	Yes	6	13	1.06"/26.9MM	0.90"/22.7MM	0.76"/19.3MM	0.34"/8.6MM	
JHWISSXM913	1/2"	9.57"/243.1MM	No	6	13	1.06"/26.9MM	0.90"/22.7MM	0.76"/19.3MM	0.34"/8.6MM	
JHWISXTM1013	1/2"	10.57"/268.5MM	Yes	6	13	1.06"/26.9MM	0.90"/22.7MM	0.76"/19.3MM	0.34"/8.6MM	
JHWISSXM1013	1/2"	10.57"/268.5MM	No	6	13	1.06"/26.9MM	0.90"/22.7MM	0.76"/19.3MM	0.34"/8.6MM	
JHWISSX-TM415	1/2"	4.09"/103.9MM	Yes	6	15	1.06"/26.9MM	0.90"/22.7MM	0.88"/22.4MM	0.42"/10.7MM	
JHWISSXM415	1/2"	4.09"/103.9MM	No	6	15	1.06"/26.9MM	0.90"/22.7MM	0.88"/22.4MM	0.42"/10.7MM	
JHWISSXTM615	1/2"	6.57"/166.9MM	Yes	6	15	1.06"/26.9MM	0.90"/22.7MM	0.88"/22.4MM	0.42"/10.7MM	
JHWISSXM615	1/2"	6.57"/166.9MM	No	6	15	1.06"/26.9MM	0.90"/22.7MM	0.88"/22.4MM	0.42"/10.7MM	
JHWISSX-TM915	1/2"	9.57"/243.1MM	Yes	6	15	1.06"/26.9MM	0.90"/22.7MM	0.88"/22.4MM	0.42"/10.7MM	
JHWISSXM915	1/2"	9.57"/243.1MM	No	6	15	1.06"/26.9MM	0.90"/22.7MM	0.88"/22.4MM	0.42"/10.7MM	
JHWISSXTM416	1/2"	4.09"/103.9MM	Yes	6	16	1.06"/26.9MM	0.90"/22.7MM	0.90"/22.7MM	0.45"/11.4MM	
JHWISSXM416	1/2"	4.09"/103.9MM	No	6	16	1.06"/26.9MM	0.90"/22.7MM	0.90"/22.7MM	0.45"/11.4MM	
JHWISSXMD416	1/2"	4.09"/103.9MM	No	12	16	1.06"/26.9MM	0.90"/22.7MM	0.90"/22.7MM	0.44"/11.2MM	
JHWISSXTM616	1/2"	6.57"/166.9MM	Yes	6	16	1.06"/26.9MM	0.90"/22.7MM	0.90"/22.7MM	0.45"/11.4MM	
JHWISSXM616	1/2"	6.57"/166.9MM	No	6	16	1.06"/26.9MM	0.90"/22.7MM	0.90"/22.7MM	0.45"/11.4MM	
JHWSPSXMD616	1/2"	6.57"/166.9MM	No	12	16	1.06"/26.9MM	0.90"/22.7MM	0.90"/22.7MM	0.44"/11.2MM	
JHWISSXTM916	1/2"	9.57"/243.1MM	Yes	6	16	1.06"/26.9MM	0.90"/22.7MM	0.90"/22.7MM	0.45"/11.4MM	
JHWISSXM916	1/2"	9.57"/243.1MM	No	6	16	1.06"/26.9MM	0.90"/22.7MM	0.90"/22.7MM	0.45"/11.4MM	
JHWISXTM1016	1/2"	10.57"/268.5MM	Yes	6	16	1.06"/26.9MM	0.90"/22.7MM	0.90"/22.7MM	0.45"/11.4MM	
JHWISSXM1016	1/2"	10.57"/268.5MM	No	6	16	1.06"/26.9MM	0.90"/22.7MM	0.90"/22.7MM	0.45"/11.4MM	
JHWISXTM1216	1/2"	12.57"/319.3MM	Yes	6	16	1.06"/26.9MM	0.90"/22.7MM	0.90"/22.7MM	0.45"/11.4MM	
JHWISSXM1216	1/2"	12.57"/319.3MM	No	6	16	1.06"/26.9MM	0.90"/22.7MM	0.90"/22.7MM	0.45"/11.4MM	
JHWISSXTM418	1/2"	4.09"/103.9MM	Yes	6	18	1.06"/26.9MM	1.00"/25.4MM	1.00"/25.4MM	0.45"/11.4MM	
JHWISSXM418	1/2"	4.09"/103.9MM	No	6	18	1.06"/26.9MM	1.00"/25.4MM	1.00"/25.4MM	0.45"/11.4MM	
JHWSPSXMD418	1/2"	4.09"/103.9MM	No	12	18	0.88"/22.4MM	1.00"/25.4MM	1.00"/25.4MM	0.30"/7.6MM	
JHWISSXTM618	1/2"	6.57"/166.9MM	Yes	6	18	1.06"/26.9MM	1.00"/25.4MM	1.00"/25.4MM	0.45"/11.4MM	
JHWISSXM618	1/2"	6.57"/166.9MM	No	6	18	1.06"/26.9MM	1.00"/25.4MM	1.00"/25.4MM	0.45"/11.4MM	
JHWSPSXMD618	1/2"	6.57"/166.9MM	No	12	18	0.88"/22.4MM	1.00"/25.4MM	1.00"/25.4MM	0.30"/7.6MM	
JHWISSXTM918	1/2"	9.57"/243.1MM	Yes	6	18	1.06"/26.9MM	1.00"/25.4MM	1.00"/25.4MM	0.45"/11.4MM	
JHWISSXM918	1/2"	9.57"/243.1MM	No	6	18	1.06"/26.9MM	1.00"/25.4MM	1.00"/25.4MM	0.45"/11.4MM	
JHWISXTM1018	1/2"	10.57"/268.5MM	Yes	6	18	1.06"/26.9MM	1.00"/25.4MM	1.00"/25.4MM	0.45"/11.4MM	
JHWISSXM1018	1/2"	10.57"/268.5MM	No	6	18	1.06"/26.9MM	1.00"/25.4MM	1.00"/25.4MM	0.45"/11.4MM	

Features

- Made in the U.S.A.
- Durable black oxide finish
- Socket retention pin is TIG welded, providing full rotation power to the socket
- Sockets feature SUPERTORQUE™ lobular openings for greater turning power without deforming the fastener
- Drive end has a 7/32" cross hole & bevel for ease of use
- Up to 30 degree angle offset
- Flexextensions are designed for use on hand and power tools (Impulse or Direct drive); NOT FOR IMPACT TOOL USE
- Maximum working torque values: 160 Ft. Lbs. /1920 In. Lbs. /217 Nm
- Other lengths and socket sizes available by special order. Contact your Snap-on Industrial Brands representative



1/2" DRIVE

SOCKETS AND DRIVE TOOLS



1/2" DRIVE IMPACT EXTENSIONS AND ACCESSORIES



Black Industrial Finish

Product Code	Description	Length (Inches)	Socket Retention
JHW4-102	Impact Extension	3 1/2	Lock Ring
JHW4-105A	Impact Extension	5	Spring Plunger
JHW4-110A	Impact Extension	10	Spring Plunger
JHW4-140B	Impact Universal Joint	2 1/2	Spring Plunger
JHW4-2F	3/8" M x 1/2" F Adapter	2 1/4	Spring Plunger
JHW4-6	3/4" M x 1/2" F Adapter	1 1/4	Through Hole

Fed. Spec: ANSI B107.2

Features

- Specially heat treated for impact use to provide long life, safety, and durability
- Spring plunger provides secure socket retention for safety and convenience
- Suitable for use with pneumatic and electric impact wrenches



Made in U.S.A.



1/2" DRIVE HEX TO SQUARE SHANK IMPACT EXTENSIONS



Black Industrial Finish

Product Code	Hex Shank Size (Inches)	Square Drive Size (Inches)	Length (Inches)
JHW4-33B	7/16	1/2	2 3/4
JHW4-35B	7/16	1/2	5
JHW4-53B	5/8	1/2	2 3/4

Features

- Specially heat treated for impact use to provide long life, safety, and durability
- Spring plunger provides secure socket retention for safety and convenience
- Suitable for use with pneumatic and electric impact wrenches



Made in U.S.A.

1/2" DRIVE SHALLOW IMPACT SOCKETS, 6 POINT, SAE



TOOLS@HEIGHT
DROP PREVENTION SYSTEM

Side hole in socket permits use with Snap-on Industrial Brands Tools@Height drive tools such as ratchets, extensions and u-joints

Black Industrial Finish

Product Code	Size (Inches)	A OAL (Inches)	B Drive End Diameter (Inches)	C Working End Diameter (Inches)	D Broach Depth (Inches)	E Bolt Clearance Depth (Inches)	Bolt Clearance Diameter (Inches)	F Nose Length (Inches)
JHW4-612	3/8	1 1/2	29/32	19/32	1/4	7/8	11/32	11/16
JHW4-614	7/16	1 1/2	29/32	23/32	5/16	7/8	13/32	11/16
JHW4-616	1/2	1 1/2	29/32	13/16	13/32	7/8	15/32	11/16
JHW4-618	9/16	1 1/2	29/32	7/8	13/32	7/8	15/32	11/16
JHW4-620	5/8	1 1/2	31/32	31/32	15/32	7/8	1/2	-
JHW4-622	11/16	1 1/2	1 1/16	1 1/16	13/16	27/32	5/8	-
JHW4-624	3/4	1 1/2	1 1/8	1 1/8	13/16	27/32	11/16	-
JHW4-626	13/16	1 1/2	1 1/4	1 1/4	13/16	13/16	25/32	-
JHW4-628	7/8	1 1/2	1 5/16	1 5/16	13/16	13/16	7/8	-
JHW4-630	15/16	1 3/4	1 3/8	1 3/8	1 1/32	1 1/16	15/16	-
JHW4-632	1	1 3/4	1 7/16	1 7/16	1 1/32	1 1/16	1	-
JHW4-634	1 1/16	2	1 9/16	1 9/16	1 1/4	1 9/32	1 1/32	-
JHW4-636	1 1/8	2	1 5/8	1 5/8	1 1/4	1 9/32	1 1/8	-
JHW4-638	1 3/16	2	1 11/16	1 11/16	1 1/4	1 9/32	1 5/32	-
JHW4-640	1 1/4	2	1 3/4	1 3/4	13/16	1 9/32	1 7/32	-
JHW4-642	1 5/16	2	1 1/2	1 7/8	7/8	1 3/8	1 1/16	-
JHW4-644	1 3/8	2	1 1/2	1 15/16	7/8	1 3/8	1 1/16	-
JHW4-646	1 7/16	2	1 1/2	2	29/32	1 3/8	1 1/16	-
JHW4-648	1 1/2	2	1 9/16	2 1/8	29/32	1 3/8	1 1/16	-

Fed. Spec: ANSI B107.2

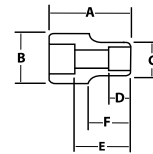

JHWWS-4-7RC 7 Piece 1/2" Drive Shallow 6 Point Impact Socket Set on Clip Rail

Contents Include:

Product Code	Size (Inches)	Product Code	Size (Inches)
JHW4-614	7/16	JHW4-622	11/16
JHW4-616	1/2	JHW4-624	3/4
JHW4-618	9/16	JHW4-626	13/16
JHW4-620	5/8		



JHWWS-4-11RC 11 Piece 1/2" Drive Shallow 6 Point Impact Socket Set on Clip Rail

Contents Include:

Product Code	Size (Inches)	Product Code	Size (Inches)	Product Code	Size (Inches)
JHW4-616	1/2	JHW4-624	3/4	JHW4-632	1
JHW4-618	9/16	JHW4-626	13/16	JHW4-634	1 1/16
JHW4-620	5/8	JHW4-628	7/8	JHW4-636	1 1/8
JHW4-622	11/16	JHW4-630	15/16		



JHWWS-4-14 14 Piece 1/2" Drive Shallow 6 Point Impact Socket Set on Clip Rail

Contents Include:

Product Code	Size (Inches)	Product Code	Size (Inches)	Product Code	Size (Inches)
JHW4-612	3/8	JHW4-622	11/16	JHW4-632	1
JHW4-614	7/16	JHW4-624	3/4	JHW4-634	1 1/16
JHW4-616	1/2	JHW4-626	13/16	JHW4-636	1 1/8
JHW4-618	9/16	JHW4-628	7/8	JHW4-640	1 1/4
JHW4-620	5/8	JHW4-630	15/16		



JHWWS-4-19RC 19 Piece 1/2" Drive Shallow 6 Point Impact Socket Set on Clip Rail

Contents Include:

Product Code	Size (Inches)	Product Code	Size (Inches)	Product Code	Size (Inches)	Product Code	Size (Inches)
JHW4-612	3/8	JHW4-622	11/16	JHW4-632	1	JHW4-642	1 5/16
JHW4-614	7/16	JHW4-624	3/4	JHW4-634	1 1/16	JHW4-644	1 3/8
JHW4-616	1/2	JHW4-626	13/16	JHW4-636	1 1/8	JHW4-646	1 7/16
JHW4-618	9/16	JHW4-628	7/8	JHW4-638	1 3/16	JHW4-648	1 1/2
JHW4-620	5/8	JHW4-630	15/16	JHW4-640	1 1/4		



Features

- SUPERTORQUE™ lobular openings for greater turning power without deforming the fastener
- Designed for maximum engagement on 6 point fasteners
- Suitable for use with pneumatic and electric impact wrenches
- Specially heat treated for impact use to provide long life, safety, and durability

1/2" DRIVE

SOCKETS AND DRIVE TOOLS



Made in U.S.A.



TOOLS @ HEIGHT
 DROP PREVENTION SYSTEM

Side hole in socket permits use with Snap-on Industrial Brands Tools@Height drive tools such as ratchets, extensions and u-joints



JHW35512



JHW37923

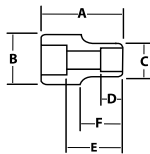

1/2" DRIVE SHALLOW IMPACT SOCKETS, 12 POINT, SAE



Black Industrial Finish

Product Code	Size (Inches)	OAL (Inches)	A	B	C	D	E	F
			Drive End Diameter (Inches)	Working End Diameter (Inches)	Broach Depth (Inches)	Bolt Clearance Depth (Inches)	Bolt Clearance Diameter (Inches)	Nose Length (Inches)
JHW35512	3/8	1 1/2	7/8	5/8	3/8	/	1/4	5/8
JHW35514	7/16	1 1/2	7/8	3/4	3/8	/	1/4	5/8
JHW35516	1/2	1 1/2	7/8	3/4	3/8	/	1/4	5/8
JHW35518	9/16	1 1/2	1	7/8	3/8	/	1/2	5/8
JHW35520	5/8	1 1/2	1	1	1/2	/	1/2	/
JHW35522	11/16	1 1/2	1	1	1/2	/	1/2	/
JHW35524	3/4	1 1/2	1	1	1/2	/	5/8	/
JHW35526	13/16	1 1/2	1 1/8	1 1/8	1/2	/	3/4	/
JHW35528	7/8	1 1/2	1 1/4	1 1/4	1/2	/	3/4	/
JHW35530	15/16	1 1/2	1 1/4	1 1/4	1/2	/	3/8	/
JHW35532	1	1 1/2	1 1/4	1 1/2	1/2	/	7/8	/
JHW35534	1 1/16	1 9/16	1 1/2	1 1/2	5/8	/	1	/
JHW35536	1 1/8	1 9/16	1 1/2	1 1/2	3/4	/	1	9/16
JHW35538	1 3/16	1 9/16	1 1/2	1 5/8	3/4	/	1	9/16
JHW35540	1 1/4	1 9/16	1 1/2	1 3/4	3/4	/	1 1/8	9/16
JHW35542	1 5/16	1 5/8	1 1/2	1 3/4	7/8	/	1 1/8	9/16
JHW35544	1 3/8	1 5/8	1 1/2	1 7/8	7/8	/	1 1/4	9/16
JHW35546	1 7/16	1 5/8	1 1/2	2	7/8	/	1 1/4	9/16
JHW35548	1 1/2	1 5/8	1 1/2	2	1	/	1 3/8	9/16

JHW37923

11 piece 1/2" Drive Impact Shallow 12 Point Socket Set on Clip Rail

Contents Include:

Product Code	Size (Inches)	Product Code	Size (Inches)	Product Code	Size (Inches)
JHW35512	3/8	JHW35520	5/8	JHW35528	7/8
JHW35514	7/16	JHW35522	11/16	JHW35530	15/16
JHW35516	1/2	JHW35524	3/4	JHW35532	1
JHW35518	9/16	JHW35526	13/16		

Features

- SUPERTORQUE™ lobular openings for greater turning power without deforming the fastener
- Designed for maximum engagement on 6 and 12 point fasteners
- Suitable for use with pneumatic and electric impact wrenches
- Specially heat treated for impact use to provide long life, safety, and durability
- Drive end features pin retention hole and groove

1/2" DRIVE UNIVERSAL IMPACT SOCKETS, 6 POINT, SAE



Black Industrial Finish

Product Code	Size (Inches)	OAL (Inches)	A	B	C	D	E	F
			Drive End Diameter (Inches)	Working End Diameter (Inches)	Broach Depth (Inches)	Bolt Clearance Depth (Inches)	Bolt Clearance Diameter (Inches)	Nose Length (Inches)
JHW37216	1/2	2 3/4	1	3/4	3/8	9/16	7/16	1
JHW37218	9/16	2 3/4	1	3/4	3/8	9/16	7/16	1
JHW37220	5/8	2 3/4	1	3/4	3/8	9/16	9/16	1
JHW37222	11/16	2 3/4	1 1/4	1	1/2	11/16	11/16	1 1/4
JHW37224	3/4	2 3/4	1 1/4	1	1/2	11/16	11/16	1 1/4
JHW37226	13/16	3	1 1/4	1 1/4	5/8	13/16	13/16	1 1/2
JHW37228	7/8	3	1 1/4	1 1/4	5/8	13/16	13/16	1 1/2

Fed. Spec: ANSI B107.2

JHW37918

7 Piece 1/2" Drive Universal 6 Point Impact Socket Set on Clip Rail

Contents Include:

Product Code	Size (Inches)	Product Code	Size (Inches)	Product Code	Size (Inches)
JHW37216	1/2	JHW37222	11/16	JHW37228	7/8
JHW37218	9/16	JHW37224	3/4		
JHW37220	5/8	JHW37226	13/16		

Features

- SUPERTORQUE™ lobular openings for greater turning power without deforming the fastener
- Designed for maximum engagement on 6 point fasteners
- Suitable for use with pneumatic and electric impact wrenches
- Specially heat treated for impact use to provide long life, safety, and durability
- Drive end features pin retention hole and groove

1/2" DRIVE

SOCKETS AND DRIVE TOOLS

1/2" DRIVE UNIVERSAL IMPACT SOCKETS, 6 POINT, METRIC



Black Industrial Finish

Product Code	Size (MM)	A OAL (Inches)	B Drive End Diameter (Inches)	C Working End Diameter (Inches)	D Broach Depth (Inches)	E Bolt Clearance Depth (Inches)	Bolt Clearance Diameter (Inches)	F Nose Length (Inches)
JHW37813	13	2 3/4	1	3/4	3/8	1/2	1/2	1
JHW37814	14	2 3/4	1	3/4	3/8	1/2	1/2	1
JHW37815	15	2 3/4	1	1	3/8	1/2	1/2	1
JHW37816	16	2 3/4	1	1	3/8	1/2	1/2	1
JHW37817	17	2 3/4	1 1/4	1	1/2	3/4	3/4	1 1/4
JHW37818	18	2 3/4	1 1/4	1	1/2	3/4	3/4	1 1/4
JHW37819	19	2 3/4	1 1/4	1	1/2	3/4	3/4	1 1/4
JHW37820	20	3	1 1/4	1 1/4	5/8	3/4	3/4	1 1/2
JHW37821	21	3	1 1/4	1 1/4	5/8	3/4	3/4	1 1/2
JHW37822	22	3	1 1/4	1 1/4	5/8	3/4	3/4	1 1/2
JHW37823	23	3	1 1/4	1 1/4	5/8	3/4	3/4	1 1/2

JHW37916 11 Piece 1/2" Drive Universal 6 Point Impact Socket Set on Clip Rail

Product Code	Size (MM)	Product Code	Size (MM)	Product Code	Size (MM)
JHW37813	13	JHW37817	17	JHW37821	21
JHW37814	14	JHW37818	18	JHW37822	22
JHW37815	15	JHW37819	19	JHW37823	23
JHW37816	16	JHW37820	20		



JHW37819



Side hole in socket permits use with Snap-on Industrial Brands Tools@Height drive tools such as ratchets, extensions and u-joints



JHW37916

Features

- SUPERTORQUE™ lobular openings for greater turning power without deforming the fastener
- Designed for maximum engagement on 6 point fasteners
- Suitable for use with pneumatic and electric impact wrenches
- Specially heat treated for impact use to provide long life, safety, and durability
- Drive end features pin retention hole and groove

1/2" DRIVE DEEP IMPACT SOCKETS, 6 POINT, SAE



Black Industrial Finish

Product Code	Size (Inches)	A OAL (Inches)	B Drive End Diameter (Inches)	C Working End Diameter (Inches)	D Broach Depth (Inches)	E Bolt Clearance Depth (Inches)	Bolt Clearance Diameter (Inches)	F Nose Length (Inches)
JHW14-612	3/8	3 1/4	29/32	19/32	5/16	2 5/8	1 1/2	2 15/32
JHW14-614	7/16	3 1/4	29/32	23/32	1 1/32	2 5/8	1 3/32	2 15/32
JHW14-616	1/2	3 1/4	29/32	19/16	13/32	2 5/8	1 5/32	2 15/32
JHW14-618	9/16	3 1/4	29/32	7/8	13/32	2 5/8	1 5/32	2 15/32
JHW14-620	5/8	3 1/4	31/32	31/32	15/32	2 7/16	5/8	-
JHW14-622	1 1/16	3 1/4	1 1/16	1 1/16	1/2	2	5/8	-
JHW14-624	3/4	3 1/4	1 1/8	1 1/8	9/16	2	1 1/16	-
JHW14-626	13/16	3 1/4	1 1/4	1 1/4	5/8	2	25/32	-
JHW14-628	7/8	3 1/2	1 5/16	1 5/16	9/16	2 1/4	7/8	-
JHW14-630	15/16	3 1/2	1 3/8	1 3/8	3/4	2 1/4	15/16	-
JHW14-632	1	3 1/2	1 7/16	1 7/16	3/4	2 1/4	1	-
JHW14-634	1 1/16	3 1/2	1 9/16	1 9/16	25/32	2 1/4	1 1/32	-
JHW14-636	1 1/8	3 1/2	1 5/8	1 5/8	13/16	2 1/4	1 1/8	-
JHW14-638	1 3/16	3 1/2	1 11/16	1 11/16	13/16	2 1/4	1 3/16	-
JHW14-640	1 1/4	3 1/2	1 3/4	1 3/4	1	2 23/32	1 1/4	-
JHW14-642	1 5/16	3 1/2	1 1/2	1 7/8	15/16	2 7/8	1 1/16	-
JHW14-644	1 3/8	3 1/2	1 1/2	2	29/32	2 7/8	1 1/16	-
JHW14-646	1 7/16	3 1/2	1 1/2	2	29/32	2 7/8	1 1/16	-
JHW14-648	1 1/2	3 1/2	1 9/16	2 1/8	29/32	2 7/8	1 1/16	-

Fed. Spec: ANSI B107.2

JHWWS-14-11 11 Piece 1/2" Drive Deep 6 Point Impact Socket Set on Clip Rail

Product Code	Size (Inches)	Product Code	Size (Inches)	Product Code	Size (Inches)
JHW14-612	3/8	JHW14-620	5/8	JHW14-628	7/8
JHW14-614	7/16	JHW14-622	1 1/16	JHW14-630	15/16
JHW14-616	1/2	JHW14-624	3/4	JHW14-632	1
JHW14-618	9/16	JHW14-626	13/16		

JHWWS1414RC 14 Piece 1/2" Drive Deep 6 Point Impact Socket Set on Clip Rail

Product Code	Size (Inches)	Product Code	Size (Inches)	Product Code	Size (Inches)
JHW14-612	3/8	JHW14-622	1 1/16	JHW14-632	1
JHW14-614	7/16	JHW14-624	3/4	JHW14-634	1 1/16
JHW14-616	1/2	JHW14-626	13/16	JHW14-636	1 1/8
JHW14-618	9/16	JHW14-628	7/8	JHW14-640	1 1/4
JHW14-620	5/8	JHW14-630	15/16		

JHWWS-1419RC 19 Piece 1/2" Drive Deep 6 Point Impact Socket Set on Clip Rail

Product Code	Size (Inches)	Product Code	Size (Inches)	Product Code	Size (Inches)	Product Code	Size (Inches)
JHW14-612	3/8	JHW14-622	1 1/16	JHW14-632	1	JHW14-642	1 5/16
JHW14-614	7/16	JHW14-624	3/4	JHW14-634	1 1/16	JHW14-644	1 3/8
JHW14-616	1/2	JHW14-626	13/16	JHW14-636	1 1/8	JHW14-646	1 7/16
JHW14-618	9/16	JHW14-628	7/8	JHW14-638	1 3/16	JHW14-648	1 1/2
JHW14-620	5/8	JHW14-630	15/16	JHW14-640	1 1/4		



JHW14-612 JHW14-624



JHWWS-14-11



JHWWS1414RC



JHWWS-1419RC

Features

- SUPERTORQUE™ lobular openings for greater turning power without deforming the fastener
- Designed for maximum engagement on 6 point fasteners
- Suitable for use with pneumatic and electric impact wrenches
- Specially heat treated for impact use to provide long life, safety, and durability

1/2" DRIVE

SOCKETS AND DRIVE TOOLS



TOOLS @ HEIGHT
DROP PREVENTION SYSTEM

Side hole in socket permits use with Snap-on Industrial Brands Tools@Height drive tools such as ratchets, extensions and u-joints

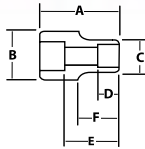

JHW4M-621

JHW4M-610



JHWMS410HRC



JHWMS4-12HRC



JHWMS-4-16RC



JHWMS-4-23RC

Features

- SUPERTORQUE™ lobular openings for greater turning power without deforming the fastener
- Designed for maximum engagement on 6 point fasteners
- Suitable for use with pneumatic and electric impact wrenches
- Specially heat treated for impact use to provide long life, safety, and durability

1/2" DRIVE SHALLOW IMPACT SOCKETS, 6 POINT, METRIC



Black Industrial Finish

Product Code	Size (MM)	A B C D E F						
		OAL (Inches)	Drive End Diameter (Inches)	Working End Diameter (Inches)	Broach Depth (Inches)	Bolt Clearance Depth (Inches)	Bolt Clearance Diameter (Inches)	Nose Length (Inches)
JHW4M-610	10	1 1/2	29/32	19/32	1/4	7/8	1 1/32	23/32
JHW4M-611	11	1 1/2	29/32	23/32	5/16	7/8	13/32	23/32
JHW4M-612	12	1 1/2	29/32	29/32	3/8	7/8	7/16	23/32
JHW4M-613	13	1 1/2	29/32	27/32	13/32	7/8	15/32	23/32
JHW4M-614	14	1 1/2	29/32	7/8	7/16	7/8	15/32	23/32
JHW4M-615	15	1 1/2	15/16	7/16	7/16	7/8	15/32	-
JHW4M-616	16	1 1/2	31/32	31/32	15/32	7/8	15/32	-
JHW4M-617	17	1 1/2	1	1	1/2	7/8	15/32	-
JHW4M-618	18	1 1/2	1 1/16	1 1/16	27/32	27/32	21/32	-
JHW4M-619	19	1 1/2	1 1/8	1 1/8	13/16	27/32	11/16	-
JHW4M-620	20	1 1/2	1 3/16	1 3/16	13/16	27/32	23/32	-
JHW4M-621	21	1 1/2	1 1/4	1 1/4	13/16	27/32	3/4	-
JHW4M-622	22	1 1/2	1 5/16	1 5/16	13/16	27/32	13/16	-
JHW4M-623	23	1 3/4	1 5/32	1 5/32	1 1/32	1 3/32	27/32	-
JHW4M-624	24	1 3/4	1 9/8	1 9/8	1 1/16	1 3/32	7/8	-
JHW4M-625	25	1 3/4	1 7/16	1 7/16	1 1/16	1 3/32	29/32	-
JHW4M-626	26	1 31/32	1 1/2	1 1/2	1 1/4	1 9/32	31/32	-
JHW4M-627	27	1 31/32	1 9/16	1 9/16	1 1/4	1 9/32	1	-
JHW4M-629	29	1 31/32	1 21/32	1 21/32	1 1/4	1 9/32	1 1/16	-
JHW4M-630	30	1 31/32	1 11/16	1 11/16	1 1/4	1 9/32	1 3/32	-
JHW4M-632	32	2	1 13/16	1 13/16	7/8	1 9/32	1 1/8	-
JHW4M-634	34	2 1/16	1 11/16	1 7/8	29/32	1 7/16	1 11/32	-
JHW4M-636	36	2 1/4	1 13/16	2	29/32	1 5/8	1 7/16	-

JHWMS410HRC

10 Piece 1/2" Drive Shallow 6 Point Impact Socket Set on Clip Rail

Contents Include:

Product Code	Size (MM)	Product Code	Size (MM)	Product Code	Size (MM)
JHW4M-610	10	JHW4M-614	14	JHW4M-618	18
JHW4M-611	11	JHW4M-615	15	JHW4M-619	19
JHW4M-612	12	JHW4M-616	16		
JHW4M-613	13	JHW4M-617	17		

JHWMS4-12HRC

12 Piece 1/2" Drive Shallow 6 Point Impact Socket Set on Clip Rail

Contents Include:

Product Code	Size (MM)	Product Code	Size (MM)	Product Code	Size (MM)
JHW4M-613	13	JHW4M-617	17	JHW4M-622	22
JHW4M-614	14	JHW4M-618	18	JHW4M-624	24
JHW4M-615	15	JHW4M-619	19	JHW4M-627	27
JHW4M-616	16	JHW4M-621	21	JHW4M-630	30

JHWMS-4-16RC

16 Piece 1/2" Drive Shallow 6 Point Impact Socket Set on Clip Rail

Contents Include:

Product Code	Size (MM)	Product Code	Size (MM)	Product Code	Size (MM)	Product Code	Size (MM)
JHW4M-610	10	JHW4M-614	14	JHW4M-618	18	JHW4M-622	22
JHW4M-611	11	JHW4M-615	15	JHW4M-619	19	JHW4M-623	23
JHW4M-612	12	JHW4M-616	16	JHW4M-620	20	JHW4M-624	24
JHW4M-613	13	JHW4M-617	17	JHW4M-621	21	JHW4M-627	27

JHWMS-4-23RC

23 Piece 1/2" Drive Shallow 6 Point Impact Socket Set on Clip Rail

Contents Include:

Product Code	Size (MM)	Product Code	Size (MM)	Product Code	Size (MM)	Product Code	Size (MM)
JHW4M-610	10	JHW4M-616	16	JHW4M-622	22	JHW4M-629	29
JHW4M-611	11	JHW4M-617	17	JHW4M-623	23	JHW4M-630	30
JHW4M-612	12	JHW4M-618	18	JHW4M-624	24	JHW4M-632	32
JHW4M-613	13	JHW4M-619	19	JHW4M-625	25	JHW4M-634	34
JHW4M-614	14	JHW4M-620	20	JHW4M-626	26	JHW4M-636	36
JHW4M-615	15	JHW4M-621	21	JHW4M-627	27		



Made in U.S.A.

1/2" DRIVE

SOCKETS AND DRIVE TOOLS

1/2" DRIVE SHALLOW IMPACT SOCKETS, 12 POINT, METRIC



TOOLS @ HEIGHT
DROP PREVENTION SYSTEM

Side hole in socket permits use with Snap-on Industrial Brands Tools@Height drive tools such as ratchets, extensions and u-joints

Black Industrial Finish

Product Code	Size (MM)	A	B	C	D	E	Bolt Clearance Diameter (Inches)	Nose Length (Inches)
		OAL (Inches)	Drive End Diameter (Inches)	Working End Diameter (Inches)	Broach Depth (Inches)	Bolt Clearance Depth (Inches)		
JHW37610	10	1 1/2	7/8	5/8	3/8	/	3/8	5/8
JHW37611	11	1 1/2	7/8	3/4	3/8	/	3/8	5/8
JHW37612	12	1 1/2	7/8	3/4	3/8	/	3/8	5/8
JHW37613	13	1 1/2	15/16	13/16	3/8	/	3/8	5/8
JHW37614	14	1 1/2	15/16	7/8	3/8	/	1/2	5/8
JHW37615	15	1 1/2	1	7/8	1/2	/	1/2	5/8
JHW37616	16	1 1/2	1	1	1/2	/	1/2	/
JHW37617	17	1 1/2	1	1	1/2	/	9/16	/
JHW37618	18	1 1/2	1	1	1/2	/	5/8	/
JHW37619	19	1 1/2	1 1/8	1 1/8	1/2	/	5/8	/
JHW37620	20	1 1/2	1 1/8	1 1/8	1/2	/	3/4	/
JHW37621	21	1 1/2	1 1/4	1 1/4	9/16	/	3/4	/
JHW37622	22	1 1/2	1 1/4	1 1/4	9/16	/	13/16	/
JHW37623	23	1 5/8	1 1/4	1 1/4	5/8	/	13/16	/
JHW37624	24	1 5/8	1 1/2	1 3/8	5/8	/	7/8	/
JHW37625	25	1 5/8	1 1/2	1 3/8	5/8	/	7/8	/
JHW37626	26	1 5/8	1 1/2	1 1/2	5/8	/	15/16	/
JHW37627	27	1 13/16	1 1/2	1 1/2	3/4	/	15/16	9/16
JHW37628	28	1 13/16	1 1/2	1 1/2	3/4	/	1	9/16
JHW37629	29	1 13/16	1 1/2	1 5/8	3/4	/	1	9/16
JHW37630	30	1 13/16	1 1/2	1 5/8	3/4	/	1	9/16
JHW37632	32	1 13/16	1 1/2	1 3/4	13/16	/	1 1/8	9/16
JHW37633	33	1 13/16	1 1/2	1 13/16	7/8	/	1 1/8	9/16
JHW37634	34	1 13/16	1 1/2	1 13/16	7/8	/	1 1/4	9/16
JHW37635	35	2	1 1/2	2	7/8	/	1 1/4	9/16
JHW37636	36	2	1 1/2	2	7/8	/	1 1/4	9/16

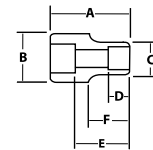

JHW37925 10 piece 1/2" Drive Impact Shallow 12 Point, MM Socket Set on Clip Rails

Contents Include:

Product Code	Size (MM)	Product Code	Size (MM)	Product Code	Size (MM)
JHW37610	10	JHW37613	13	JHW37616	16
JHW37611	11	JHW37614	14	JHW37617	17
JHW37612	12	JHW37615	15	JHW37618	18
				JHW37619	19

Features

- SUPERTORQUE™ lobular openings for greater turning power without deforming the fastener
- Designed for maximum engagement on 6 and 12 point fasteners
- Suitable for use with pneumatic and electric impact wrenches
- Specially heat treated for impact use to provide long life, safety, and durability



1/2" DRIVE

SOCKETS AND DRIVE TOOLS



TOOLS @ HEIGHT
DROP PREVENTION SYSTEM

Side hole in socket permits use with Snap-on Industrial Brands Tools@Height drive tools such as ratchets, extensions and u-joints

1/2" DRIVE DEEP IMPACT SOCKETS, 6 POINT, METRIC



Black Industrial Finish

Product Code	Size (MM)	A OAL (Inches)	B Drive End Diameter (Inches)	C Working End Diameter (Inches)	D Broach Depth (Inches)	E Bolt Clearance Depth (Inches)	F Bolt Clearance Diameter (Inches)	Nose Length (Inches)
JHW14M-610	10	3 1/4	29/32	19/32	9/32	2 9/16	1 5/32	2 15/32
JHW14M-611	11	3 1/4	29/32	23/32	21/64	2 9/16	1 3/32	2 15/32
JHW14M-612	12	3 1/4	29/32	49/64	23/64	2 9/16	7/16	2 15/32
JHW14M-613	13	3 1/4	29/32	53/64	25/64	2 9/16	15/32	2 15/32
JHW14M-614	14	3 1/4	29/32	7/8	13/32	2 9/16	15/32	2 15/32
JHW14M-615	15	3 1/4	15/16	15/16	13/32	2 7/64	33/64	-
JHW14M-616	16	3 1/4	31/32	31/32	29/64	1 31/32	17/32	-
JHW14M-617	17	3 1/4	1	1	27/64	1 31/32	39/64	-
JHW14M-618	18	3 1/4	1 1/16	1 1/16	1/2	1 31/32	21/32	-
JHW14M-619	19	3 1/4	1 1/4	1 1/4	35/64	1 61/64	11/16	-
JHW14M-620	20	3 1/4	1 3/16	1 3/16	35/64	1 61/64	23/32	-
JHW14M-621	21	3 1/4	1 1/4	1 1/4	35/64	1 61/64	3/4	-
JHW14M-622	22	3 1/2	1 9/16	1 9/16	35/64	2 7/64	51/64	-
JHW14M-623	23	3 1/2	1 11/32	1 11/32	5/8	2 7/64	53/64	-
JHW14M-624	24	3 1/2	1 3/8	1 3/8	5/8	2 7/64	7/8	-
JHW14M-625	25	3 1/2	1 7/16	1 7/16	5/8	2 7/64	29/32	-
JHW14M-626	26	3 1/2	1 31/64	1 31/64	5/8	2 7/64	15/16	-
JHW14M-627	27	3 1/2	1 9/16	1 9/16	25/32	2 7/64	31/32	-
JHW14M-629	29	3 1/2	1 5/8	1 5/8	13/16	2 7/64	1 1/16	-
JHW14M-630	30	3 1/2	1 11/16	1 11/16	53/64	2 21/32	1 3/32	-
JHW14M-632	32	3 1/2	1 13/16	1 13/16	7/8	2 21/32	1 1/4	-
JHW14M-634	34	3 1/2	1 3/4	1 15/16	57/64	2 55/64	1 21/64	-
JHW14M-635	35	3 1/2	1 3/4	2	57/64	2 55/64	1 23/64	-
JHW14M-636	36	3 1/2	1 3/4	2	57/64	2 13/16	1 1/8	-



JHWMS1410HRC 10 Piece 1/2" Drive Deep 6 Point Impact Socket Set on Clip Rail

Contents Include:

Product Code	Size (MM)	Product Code	Size (MM)	Product Code	Size (MM)
JHW14M-610	10	JHW14M-614	14	JHW14M-618	18
JHW14M-611	11	JHW14M-615	15	JHW14M-619	19
JHW14M-612	12	JHW14M-616	16		
JHW14M-613	13	JHW14M-617	17		



JHWMS-1416RC 16 Piece 1/2" Drive Deep 6 Point Impact Socket Set on Clip Rail

Contents Include:

Product Code	Size (MM)	Product Code	Size (MM)	Product Code	Size (MM)	Product Code	Size (MM)
JHW14M-610	10	JHW14M-614	14	JHW14M-618	18	JHW14M-622	22
JHW14M-611	11	JHW14M-615	15	JHW14M-619	19	JHW14M-623	23
JHW14M-612	12	JHW14M-616	16	JHW14M-620	20	JHW14M-624	24
JHW14M-613	13	JHW14M-617	17	JHW14M-621	21	JHW14M-627	27

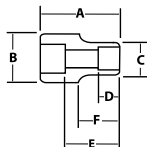

JHWMS-1424RC 24 Piece 1/2" Drive Deep 6 Point Impact Socket Set on Clip Rail

Contents Include:

Product Code	Size (MM)	Product Code	Size (MM)	Product Code	Size (MM)	Product Code	Size (MM)
JHW14M-610	10	JHW14M-616	16	JHW14M-622	22	JHW14M-629	29
JHW14M-611	11	JHW14M-617	17	JHW14M-623	23	JHW14M-630	30
JHW14M-612	12	JHW14M-618	18	JHW14M-624	24	JHW14M-632	32
JHW14M-613	13	JHW14M-619	19	JHW14M-625	25	JHW14M-634	34
JHW14M-614	14	JHW14M-620	20	JHW14M-626	26	JHW14M-635	35
JHW14M-615	15	JHW14M-621	21	JHW14M-627	27	JHW14M-636	36

Features

- SUPERTORQUE™ lobular openings for greater turning power without deforming the fastener
- Designed for maximum engagement on 6 point fasteners
- Suitable for use with pneumatic and electric impact wrenches
- Specially heat treated for impact use to provide long life, safety, and durability



1/2" DRIVE SOCKETS AND DRIVE TOOLS

1/2" DRIVE DEEP IMPACT SOCKETS, 12 POINT, SAE



Black Industrial Finish

Product Code	Size (Inches)	A	B	C	D	E
		Overall Length (Inches)	Drive End Diameter (Inches)	Working End Diameter (Inches)	Broach Depth (Inches)	Bolt Clearance Depth (Inches)
JHW14-1216	1/2	3 1/4	7/8	1 1/16	3/8	2 9/16
JHW14-1218	9/16	3 1/4	7/8	7/8	7/16	2 9/16
JHW14-1220	5/8	3 1/4	15/16	15/16	7/16	2 9/16
JHW14-1222	11/16	3 1/4	1 1/16	1 1/16	1/2	2 1/4
JHW14-1224	3/4	3 1/4	1 1/8	1 1/8	9/16	2 1/4
JHW14-1226	13/16	3 1/4	1 1/4	1 1/4	9/16	2 1/4
JHW14-1228	7/8	3 1/2	1 5/16	1 9/16	5/8	2 1/2
JHW14-1230	15/16	3 1/2	1 3/8	1 3/8	11/16	2 1/2
JHW14-1232	1	3 1/2	1 7/16	1 7/16	3/4	2 1/2
JHW14-1234	1 1/16	3 1/2	1 9/16	1 9/16	3/4	2 1/2
JHW14-1236	1 1/8	3 1/2	1 9/8	1 5/8	13/16	2 1/2
JHW14-1238	1 3/16	3 1/2	1 11/16	1 11/16	13/16	2 7/16
JHW14-1240	1 1/4	3 1/2	1 3/4	1 3/4	7/8	2 7/16

Features

- SUPERTORQUE™ lobular openings for greater turning power without deforming the fastener
- Designed for maximum engagement on 6- and 12-point fasteners
- Suitable for use with pneumatic and electric impact wrenches
- Specially heat-treated for impact use to provide long life, safety, and durability



Made in U.S.A.



JHW14-1218

1/2" DRIVE DEEP IMPACT SOCKETS, 12 POINT, METRIC



Black Industrial Finish

Product Code	Size (MM)	A	B	C	D	E
		Overall Length (MM)	Drive End Diameter (MM)	Working End Diameter (MM)	Broach Depth (MM)	Bolt Clearance Depth (MM)
JHW14M-1210	10	83	23	17	8	66
JHW14M-1211	11	83	23	18	9	66
JHW14M-1212	12	83	23	19	10	66
JHW14M-1213	13	83	23	21	10	66
JHW14M-1214	14	83	23	22	11	66
JHW14M-1215	15	83	24	24	11	66
JHW14M-1216	16	83	24	24	12	66
JHW14M-1217	17	83	25	25	11	58
JHW14M-1218	18	83	27	27	13	58
JHW14M-1219	19	83	29	29	14	58
JHW14M-1220	20	83	30	30	14	58
JHW14M-1221	21	83	32	32	14	57
JHW14M-1222	22	89	33	33	18	63
JHW14M-1223	23	89	34	34	18	64
JHW14M-1224	24	89	35	35	19	63
JHW14M-1225	25	89	36	36	19	63
JHW14M-1227	27	89	40	40	20	63
JHW14M-1229	29	89	41	41	21	63
JHW14M-1230	30	89	43	43	22	62
JHW14M-1232	32	89	46	46	22	63
JHW14M-1233	33	89	46	46	22	62

Features

- SUPERTORQUE™ lobular openings for greater turning power without deforming the fastener
- Designed for maximum engagement on 6- and 12-point fasteners
- Suitable for use with pneumatic and electric impact wrenches
- Specially heat-treated for impact use to provide long life, safety, and durability



Made in U.S.A.



JHW14M-1212

1/2" DRIVE

SOCKETS AND
DRIVE TOOLS





JHWWSH-43TB

43 PIECE 3/4" DRIVE SOCKET AND DRIVE TOOL SET



12 Point SAE, with Metal Box

Product Code	Description
JHWWSH-43TB	43 Piece Tool Set with JHWTB-12 Metal Tool Box
JHWWSH-43	43 Piece Tool Set Only

Contents Include:

Drive Tools:		Shallow 12-Point Sockets			
Product Code	Description	Product Code	Size (Inches)	Product Code	Size (Inches)
JHWH-20A	19" Sliding T-Handle	JHWH-1224	3/4	JHWH-1250	1 3/16
JHWH-41AA	22" Flex Handle	JHWH-1226	13/16	JHWH-1252	1 5/8
JHWH-51B	20" Ratchet	JHWH-1228	7/8	JHWH-1254	1 11/16
JHWH-104	3" Extension	JHWH-1230	15/16	JHWH-1256	1 3/4
JHWH-110	8" Extension	JHWH-1232	1	JHWH-1258	1 13/16
JHWH-115	16" Extension	JHWH-1234	1 1/16	JHWH-1260	1 7/8
JHWH-140A	Universal Joint	JHWH-1236	1 1/8	JHWH-1264	2
		JHWH-1238	1 3/16	JHWH-1266	2 1/16
		JHWH-1240	1 1/4	JHWH-1268	2 1/8
		JHWH-1242	1 5/16	JHWH-1270	2 3/16
		JHWH-1244	1 3/8	JHWH-1272	2 1/4
		JHWH-1246	1 7/16	JHWH-1276	2 3/8
		JHWH-1248	1 1/2		

Deep 12-Point Sockets

Product Code	Size (Inches)
JHWH-628	7/8
JHWH-630	15/16
JHWH-632	1
JHWH-634	1 1/16
JHWH-636	1 1/8
JHWH-640	1 1/4
JHWH-642	1 5/16
JHWH-644	1 3/8
JHWH-646	1 7/16
JHWH-648	1 1/2
JHWH-652	1 5/8

Features

- All tools are professional quality, made of high-grade chrome vanadium steel
- Sockets feature SUPERTORQUE™ lobular openings for greater turning power without deforming the fastener
- Metal tool box made for years of rugged use



29 PIECE 3/4" DRIVE SOCKET AND DRIVE TOOL SET



12 Point SAE, with Metal Box

Product Code	Description
JHWWSH-29TB	29 Piece Tool Set with JHWTB-6124B Metal Tool Box
JHWWSH-29	29 Piece Tool Set Only

Contents Include:

Drive Tools:		Shallow 12-Point Sockets	
Product Code	Description	Product Code	Size (Inches)
JHWH-20A	19" Sliding T-Handle	JHWH-1242	1 5/16
JHWH-41AA	22" Flex Handle	JHWH-1244	1 3/8
JHWH-51B	20" Ratchet	JHWH-1246	1 7/16
JHWH-104	3" Extension	JHWH-1248	1 1/2
JHWH-110	8" Extension	JHWH-1250	1 9/16
JHWH-115	16" Extension	JHWH-1252	1 5/8
JHWH-140A	Universal Joint	JHWH-1254	1 11/16
		JHWH-1256	1 3/4
		JHWH-1258	1 13/16
		JHWH-1260	1 7/8
		JHWH-1264	2
		JHWH-1268	2 1/8
		JHWH-1270	2 3/16
		JHWH-1272	2 1/4
		JHWH-1276	2 3/8

Shallow 12-Point Sockets	
Product Code	Size (Inches)
JHWH-1228	7/8
JHWH-1230	15/16
JHWH-1232	1
JHWH-1234	1 1/16
JHWH-1236	1 1/8
JHWH-1238	1 3/16
JHWH-1240	1 1/4

Features

- All tools are professional quality, made of high-grade chrome vanadium steel
- Sockets feature SUPERTORQUE™ lobular openings for greater turning power without deforming the fastener
- Metal tool box made for years of rugged use



Made in U.S.A.



JHWWSH-29TB

22 PIECE 3/4" DRIVE SOCKET AND DRIVE TOOL SET



12 Point SAE, with Metal Box

Product Code	Description
JHWWSH-22TB	22 Piece Tool Set with JHWTB-49 Metal Tool Box
JHWWSH-22	22 Piece Tool Set Only

Contents Include:

Drive Tools:		Shallow 12-Point Sockets	
Product Code	Description	Product Code	Size (Inches)
JHWH-41AA	22" Flex Handle	JHWH-1236	1 1/8
JHWH-51B	20" Ratchet	JHWH-1240	1 1/4
JHWH-104	3" Extension	JHWH-1242	1 3/16
JHWH-110	8" Extension	JHWH-1244	1 3/8
JHWH-115	16" Extension	JHWH-1246	1 7/16
JHWH-140A	Universal Joint	JHWH-1248	1 1/2
		JHWH-1252	1 5/8
		JHWH-1254	1 11/16
		JHWH-1256	1 3/4
		JHWH-1258	1 13/16
		JHWH-1260	1 7/8
		JHWH-1264	2

Shallow 12-Point Sockets	
Product Code	Size (Inches)
JHWH-1228	7/8
JHWH-1230	15/16
JHWH-1232	1
JHWH-1234	1 1/16

Features

- All tools are professional quality, made of high-grade chrome vanadium steel
- Sockets feature SUPERTORQUE™ lobular openings for greater turning power without deforming the fastener
- Metal tool box made for years of rugged use



Made in U.S.A.



JHWWSH-22TB

3/4" DRIVE

SOCKETS AND DRIVE TOOLS



13 PIECE 3/4" DRIVE SOCKET AND DRIVE TOOL SET



JHWWSH-13TB

12 Point SAE, with Metal Box

Product Code	Description
JHWWSH-13TB	13 Piece Tool Set with JHWTB-49 Metal Tool Box
JHWWSH-13	13 Piece Tool Set Only

Contents Include:

Drive Tools:		Shallow 12-Point Sockets	
Product Code	Description	Product Code	Size (Inches)
JHWH-51B	20" Ratchet	JHWH-1234	1 1/16
JHWH-110	8" Extension	JHWH-1236	1 1/8
		JHWH-1240	1 1/4
		JHWH-1242	1 5/16
		JHWH-1244	1 3/8
		JHWH-1246	1 7/16
		JHWH-1248	1 1/2
		JHWH-1252	1 5/8

Features

- All tools are professional quality, made of high-grade chrome vanadium steel
- Sockets feature SUPERTORQUE™ lobular openings for greater turning power without deforming the fastener
- Metal tool box made for years of rugged use



Made in U.S.A.

20 PIECE 3/4" DRIVE SOCKET AND DRIVE TOOL SET



JHWMSh-20TB

12 Point Metric, with Metal Box

Product Code	Description
JHWMSh-20TB	20 Piece Tool Set with JHWTB-49 Metal Tool Box
JHWMSh-20	20 Piece Tool Set Only

Contents Include:

Drive Tools:		Shallow 12-Point Sockets	
Product Code	Description	Product Code	Size (MM)
JHWH-41AA	22" Flex Handle	JHWHM-1230	30
JHWH-51B	20" Ratchet	JHWHM-1232	32
JHWH-110	8" Extension	JHWHM-1235	35
JHWH-115	16" Extension	JHWHM-1236	36
JHWH-140A	Universal Joint	JHWHM-1238	38
		JHWHM-1241	41
		JHWHM-1246	46
		JHWHM-1250	50
		JHWHM-1254	54
		JHWHM-1255	55
		JHWHM-1260	60

Features

- All tools are professional quality, made of high-grade chrome vanadium steel
- Sockets feature SUPERTORQUE™ lobular openings for greater turning power without deforming the fastener
- Metal tool box made for years of rugged use



Made in U.S.A.

3/4" DRIVE
SOCKETS AND
DRIVE TOOLS

3/4" DRIVE INTEGRATED HANDLE RATCHETS

Chrome and Black Industrial Finish

Product Code	Description	Length (Inches)	Number of Teeth
JHWH-51B	Chrome Ratchet	20 1/8	32
JHWHB-51B	Black Finish Ratchet	20 1/8	32
JHWH-52EHRK	Repair Kit for JHWH-51B and JHWHB-51B		

Fed. Spec: ANSI B107.10M

Features

- Forged one-piece ratchet provide strength and safety for industrial applications
- Smooth comfort-grip handle permits all-day use without gloves
- 32 tooth gear with 11 degree of engagement allows engagement in tight working areas
- Single Pawl ratchet design:
 - 1) Designed for tighter tolerances between pawl and gear which reduces metal fatigue and slippage under load
 - 2) Does not require as many working parts, reducing possible breakage and parts to repair
- Easy access reverse lever allows user to change working direction quickly and easily with only one hand
- Ball and Spring socket retention



JHWH-51B



JHWHB-51B

3/4" DRIVE REMOVABLE-HANDLE RATCHETS

Knurled Handle, Chrome Finish

Product Code	Description	Length (Inches)	Number of Teeth
--------------	-------------	-----------------	-----------------

Complete Ratchet

JHWH-51AB1	Ratchet with 19 1/4" Handle	24 11/16	32
------------	-----------------------------	----------	----

Components

JHWH-51AB	Ratchet Head Only	6	32
JHWH-A1	Handle Only	19 1/4	
JHWH-52EHRKA	Repair Kit for JHWH-51AB1 and JHWH-51AB		

Note: Head Bore and Handle End Diameter: 13/16"

Fed. Spec: ANSI B107.10M

Features

- 32 teeth action provides an 11° ratcheting angle
- Shift lever reverses action instantly
- Ball and spring provide firm socket retention
- Removable handle makes the tool more versatile, and storage easier
- Knurled handle provides a non-slip grip
- Chrome finish models provides increased protection from rust and corrosion
- Our most rugged, high torque capacity ratchet



JHWH-51AB1



JHWH-51AB



JHWH-A1

3/4" DRIVE

SOCKETS AND
DRIVE TOOLS

3/4" DRIVE HANDLES

Chrome and Black Industrial Finish

Product Code	Description	Length (Inches)	Finish
JHWH-41AA	Flex Handle Breaker Bar, Knurled Grip	22 1/8	Chrome
JHWH-20A	Sliding T-Handle	19 1/4	Chrome
JHWHB-20A	Sliding T-Handle	19 1/4	Black Industrial

Fed. Spec: ANSI B107.10M

Features

- Chrome plating provides increased protection from rust and corrosion
- Drive handles provide extra leverage with greater strength than ratchets
- Square drive slides on T-Handles for versatility
- Flex handle flex drive swivels 110° in either direction



JHWH-41AA



JHWH-20A



JHWHB-20A



JHWH-104



JHWH-104B



JHWH-110

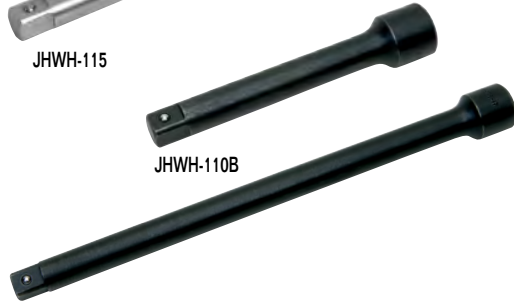

JHWH-110B

JHWH-115B

3/4" DRIVE EXTENSIONS

Chrome and Black Industrial Finish

Product Code	Length (Inches)
--------------	-----------------

Chrome Finish

JHWH-104	3
JHWH-110	8
JHWH-115	16

Black Industrial Finish

JHWH-104B	3
JHWH-110B	8
JHWH-115B	16

Fed. Spec: ANSI B107.10M

Features

- Chrome plating provides increased protection from rust and corrosion
- Ball and spring socket retention



Made in U.S.A.



JHWHNX-130



JHWHNX-131



JHW33008



JHWHNX-130B



JHWHNX-131B

3/4" DRIVE ADAPTERS

Chrome and Black Industrial Finish

Product Code	Length (Inches)	Male End (Inches)	Female End (Inches)	Female End Detent
--------------	-----------------	-------------------	---------------------	-------------------

Chrome Finish

JHWHNX-130	3	1	3/4	Detent on Each Wall
JHWHNX-131	3 1/16	3/4	1	Drilled Hole
JHW33008	2 1/8	1/2	3/4	Drilled Hole

Black Industrial Finish

JHWHNX-130B	3	1	3/4	Detent on Each Wall
JHWHNX-131B	3 1/16	3/4	1	Drilled Hole

Fed. Spec: ANSI B107.10M

Features

- Chrome plating provides increased protection from rust and corrosion
- Ball and spring socket retention



Made in U.S.A.



JHWH-140A



JHWHB-140A

3/4" DRIVE UNIVERSAL JOINTS

Chrome and Black Industrial Finish

Product Code	Description	Length (Inches)
--------------	-------------	-----------------

Chrome Finish

JHWH-140A	Universal Joint	4 1/16
-----------	-----------------	--------

Black Industrial Finish

JHWHB-140A	Universal Joint	4 1/16
------------	-----------------	--------

Features

- Chrome plating provides increased protection from rust and corrosion
- Ball and spring socket retention



Made in U.S.A.



3/4" DRIVE SHALLOW 12 POINT SOCKETS, SAE

High-Polished Chrome Finish

Product Code	Size (Inches)	A	B	C	D	E	F	
		OAL (Inches)	Drive End Diameter (Inches)	Working End Diameter (Inches)	Broach Depth (Inches)	Bolt Clearance Depth (Inches)	Bolt Clearance Diameter (Inches)	Nose Length (Inches)
JHWH-1224	3/4	2	1 7/16	1 1/8	17/32	1 1/4	1 1/16	13/16
JHWH-1226	13/16	2	1 7/16	1 7/32	9/16	1 1/4	1 1/16	13/16
JHWH-1228	7/8	2	1 7/16	1 3/16	19/32	1 1/4	1 1/16	13/16
JHWH-1230	15/16	2	1 7/16	1 3/8	21/32	1 1/4	1 1/16	13/16
JHWH-1231	31/32	2	1 7/16	1 13/32	11/16	1 1/4	1 1/16	13/16
JHWH-1232	1	2 1/16	1 7/16	1 15/32	11/16	1 5/16	1 1/16	25/32
JHWH-1234	1 1/16	2 1/8	1 1/2	1 9/16	3/4	1 5/32	1 1/32	7/8
JHWH-1236	1 1/8	2 3/16	1 1/2	1 5/8	13/16	1 7/32	1 1/8	29/32
JHWH-1238	1 3/16	2 1/4	1 1/2	1 11/16	27/32	1 9/32	1 3/32	31/32
JHWH-1240	1 1/4	2 1/2	1 1/2	1 3/4	27/32	1 11/32	1 9/32	15/16
JHWH-1242	1 3/16	2 5/16	1 5/8	1 7/8	27/32	1 13/32	1 11/32	1
JHWH-1244	1 3/8	2 3/16	1 5/8	1 15/16	7/8	1 3/8	1 7/16	1
JHWH-1246	1 7/16	2 3/8	1 5/8	2	15/16	1 7/16	1 1/4	1
JHWH-1248	1 1/2	2 1/2	1 5/8	2 1/8	1	1 9/16	1 1/4	1 1/8
JHWH-1250	1 9/16	2 5/8	1 3/4	2 3/16	1 5/32	1 11/16	1 3/8	1 1/4
JHWH-1252	1 5/8	2 5/8	1 3/4	2 1/4	1 5/32	1 11/16	1 3/8	1 1/4
JHWH-1254	1 11/16	2 3/4	1 29/32	2 3/8	1 3/16	1 13/16	1 3/8	1 3/8
JHWH-1256	1 3/4	2 3/4	1 3/4	2 7/16	1 3/16	1 13/16	1 3/8	1 3/8
JHWH-1258	1 13/16	2 7/8	1 3/4	2 1/2	1 1/4	1 31/32	1 9/16	1 7/16
JHWH-1260	1 7/8	3	1 3/4	2 9/16	1 9/16	2 1/16	1 9/16	1 9/16
JHWH-1264	2	3 1/8	1 3/4	2 3/4	1 9/16	2 3/16	1 9/16	1 11/16
JHWH-1266	2 1/16	3 1/8	1 3/4	2 3/4	1 3/8	2 3/16	1 9/16	1 11/16
JHWH-1268	2 1/8	3 1/4	1 3/4	2 15/16	1 7/16	2 5/16	1 5/16	1 13/16
JHWH-1270	2 3/16	3 1/4	1 3/4	2 15/16	1 1/2	2 9/16	1 9/16	1 13/16
JHWH-1272	2 1/4	3 3/8	1 3/4	3 1/8	1 1/2	2 7/16	1 1/4	1 7/8
JHWH-1274	2 5/16	3 1/2	1 3/4	3 1/4	1 5/8	2 9/16	1 1/4	2
JHWH-1276	2 3/8	3 5/8	1 3/4	3 1/4	1 3/4	2 11/16	1 1/4	2 1/8

Fed. Spec: ANSI B107.110



JHWH-1240

JHWH-1224

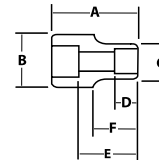

JHWWSH-16TB

16 Piece 3/4" Drive Shallow 12-Point Socket Set with JHWTB-49 Tool Box

JHWWSH-16RC

16 Piece 3/4" Drive Shallow 12-Point Socket Set on Clip Rails

Contents Include:

Product Code	Size (Inches)	Product Code	Size (Inches)	Product Code	Size (Inches)	Product Code	Size (Inches)
JHWH-1228	7/8	JHWH-1236	1 1/8	JHWH-1246	1 7/16	JHWH-1256	1 3/4
JHWH-1230	15/16	JHWH-1240	1 1/4	JHWH-1248	1 1/2	JHWH-1258	1 13/16
JHWH-1232	1	JHWH-1242	1 5/16	JHWH-1252	1 5/8	JHWH-1260	1 7/8
JHWH-1234	1 1/16	JHWH-1244	1 3/8	JHWH-1254	1 11/16	JHWH-1264	2



JHWWSH-16TB

JHWWSH-26RC

26 Piece 3/4" Drive Shallow 12-Point Socket Set on Clip Rails

Contents Include:

Product Code	Size (Inches)	Product Code	Size (Inches)	Product Code	Size (Inches)	Product Code	Size (Inches)
JHWH-1224	3/4	JHWH-1238	1 3/16	JHWH-1252	1 5/8	JHWH-1268	2 1/8
JHWH-1226	13/16	JHWH-1240	1 1/4	JHWH-1254	1 11/16	JHWH-1270	2 3/16
JHWH-1228	7/8	JHWH-1242	1 5/16	JHWH-1256	1 3/4	JHWH-1272	2 1/4
JHWH-1230	15/16	JHWH-1244	1 3/8	JHWH-1258	1 13/16	JHWH-1274	2 5/16
JHWH-1232	1	JHWH-1246	1 7/16	JHWH-1260	1 7/8	JHWH-1276	2 3/8
JHWH-1234	1 1/16	JHWH-1248	1 1/2	JHWH-1264	2		
JHWH-1236	1 1/8	JHWH-1250	1 9/16	JHWH-1266	2 1/16		



JHWWSH-26RC

Features

- SUPERTORQUE™ lobular openings for greater turning power without deforming the fastener
- Designed for quick engagement on both 6 and 12 point fasteners



3/4" DRIVE

SOCKETS AND DRIVE TOOLS





3/4" DRIVE DEEP SOCKETS, 6 POINT, SAE

High-Polished Chrome Finish



JHWHD-640

JHWHD-628

Product Code	Size (Inches)	A OAL (Inches)	B Drive End Diameter (Inches)	C Working End Diameter (Inches)	D Broach Depth (Inches)	E Bolt Clearance Depth (Inches)	Bolt Clearance Diameter (Inches)	F Nose Length (Inches)
JHWHD-630	1 1/16	3 1/2	1 7/16	1 3/8	2 1/32	2 1/2	1 1/16	2 5/16
JHWHD-632	1	3 1/2	1 1/2	1 7/16	23/32	2 1/2	1 1/16	2 5/16
JHWHD-634	1 1/16	3 1/2	1 1/2	1 9/16	3/4	2 1/2	3/4	2 7/32
JHWHD-636	1 1/8	3 1/2	1 1/2	1 5/8	13/16	2 1/2	25/32	2 7/32
JHWHD-640	1 1/4	3 1/2	1 1/2	1 3/4	1	2 1/2	7/8	2 3/16
JHWHD-642	1 5/16	3 1/2	1 5/8	1 7/8	1	2 1/2	15/16	2 3/16
JHWHD-644	1 3/8	3 1/2	1 5/8	1 15/16	1	2 9/16	1 3/8	2 3/16
JHWHD-646	1 7/16	3 1/2	1 5/8	2	1	2 9/16	1 7/16	2 1/8
JHWHD-648	1 1/2	3 1/2	1 5/8	2 1/16	1 1/4	2 9/16	1 1/2	2 1/8
JHWHD-652	1 5/8	3 1/2	1 3/4	2 1/4	1 3/8	2 9/16	1 5/8	2 1/8

Fed. Spec: ANSI B107.110

JHWWSHD11HRC 11 Piece 3/4" Drive Deep 6 Point Socket Set on Clip Rail

Contents Include:



JHWWSHD11HRC

Product Code	Size (Inches)	Product Code	Size (Inches)	Product Code	Size (Inches)
JHWHD-628	7/8	JHWHD-636	1 1/8	JHWHD-646	1 7/16
JHWHD-630	1 1/16	JHWHD-640	1 1/4	JHWHD-648	1 1/2
JHWHD-632	1	JHWHD-642	1 5/16	JHWHD-652	1 5/8
JHWHD-634	1 1/16	JHWHD-644	1 3/8		

Features

- SUPERTORQUE™ lobular openings for greater turning power without deforming the fastener
- Designed for maximum engagement on 6 point fasteners

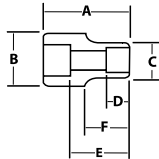

3/4" DRIVE DEEP SOCKET, 6 POINT, METRIC



High-Polished Chrome Finish



JHW33730

JHW33719

Product Code	Size (MM)	A Overall Length (Inches)	B Drive End Diameter (Inches)	C Working End Diameter (Inches)	D Broach Depth (Inches)	E Bolt Clearance Depth (Inches)	Bolt Clearance Diameter (Inches)
JHW33722	22	3 35/64	1 27/64	1 17/64	1 1/64	1 3/16	45/64
JHW33723	23	3 35/64	1 27/64	1 5/16	1 1/64	1 3/16	45/64
JHW33724	24	3 35/64	1 27/64	1 11/32	1 1/64	1 3/16	45/64
JHW33727	27	3 35/64	1 27/64	1 1/2	1 7/64	1 3/16	15/16
JHW33730	30	3 35/64	1 27/64	1 21/32	1 1/64	1 3/16	1 1/16
JHW33732	32	3 35/64	1 27/64	1 47/64	1 1/64	1 3/16	1 9/64
JHW33735	35	3 35/64	1 1/2	1 57/64	1 3/16	1 7/64	1 17/64
JHW33736	36	3 35/64	1 1/2	1 31/32	1 3/16	1 7/64	1 19/64
JHW33738	38	3 35/64	1 1/2	2 1/32	1 11/32	15/16	1 3/8
JHW33741	41	3 35/64	1 37/64	2 13/64	1 11/32	15/16	1 1/2
JHW33746	46	3 35/64	1 21/32	2 7/16	1 11/32	15/16	1 21/32
JHW33750	50	3 35/64	1 21/32	2 43/64	1 27/64	15/16	1 21/32
JHW33755	55	3 15/16	1 49/64	2 29/32	1 1/2	25/32	1 11/16
JHW33760	60	3 61/64	1 49/64	3 5/32	1 37/64	5/8	1 49/64

JHW33932 15 piece 3/4" Drive Deep 6 Point Socket Set in Clip and Rails

Contents Include:



JHW33932

Product Code	Size (MM)	Product Code	Size (MM)	Product Code	Size (MM)
JHW33719	19	JHW33727	27	JHW33736	36
JHW33722	22	JHW33730	30	JHW33738	38
JHW33723	23	JHW33732	32	JHW33741	41
JHW33724	24	JHW33735	35	JHW33746	46
				JHW33750	50
				JHW33755	55
				JHW33760	60

Features

- SUPERTORQUE™ lobular openings for greater turning power without deforming the fastener
- Designed for maximum engagement on 6 point fasteners

3/4" DRIVE

SOCKETS AND
DRIVE TOOLS



3/4" DRIVE SHALLOW SOCKETS, 12 POINT, METRIC

High-Polished Chrome Finish

Product Code	Size (MM)	A	B	C	D	E	Bolt Clearance Diameter (Inches)	Nose Length (Inches)
		OAL (Inches)	Drive End Diameter (Inches)	Working End Diameter (Inches)	Broach Depth (Inches)	Bolt Clearance Depth (Inches)		
JHWHM-1219	19	2	7/16	1 1/8	9/16	1 1/32	1 1/16	1 3/16
JHWHM-1222	22	2	7/16	1 1/4	5/8	1 1/32	1 1/16	1 3/16
JHWHM-1223	23	2	1 7/16	1 11/32	5/8	1 1/32	3/4	9/16
JHWHM-1224	24	2	7/16	1 3/8	21/32	1 1/32	1 1/16	1 3/16
JHWHM-1225	25	2	1 7/16	1 7/16	2 3/32	1 1/32	3/4	2
JHWHM-1226	26	2	1 1/2	1 1/2	2 3/32	1 1/32	1 1/2	2
JHWHM-1227	27	2	1 1/2	1 9/16	3/4	1 1/32	1 1/16	1 1/16
JHWHM-1228	28	2	1 1/2	1 21/32	25/32	1 1/32	1-3/32	1-7/32
JHWHM-1230	30	2 7/32	1 1/2	1 5/8	13/16	1 7/32	1 3/16	27/32
JHWHM-1232	32	2 1/4	1 1/2	1 3/4	7/8	1 5/16	1 5/16	7/8
JHWHM-1235	35	2 9/16	1 5/8	1 15/16	29/32	1 13/32	1 7/16	7/8
JHWHM-1236	36	2 5/16	1 5/8	1 15/16	29/32	1 13/32	1 1/4	7/8
JHWHM-1238	38	2 1/2	1 5/8	2 1/16	1	1 19/32	1 9/16	1 1/16
JHWHM-1241	41	2 5/8	1 3/4	2 3/16	1 1/16	1 23/32	1 13/32	1 3/16
JHWHM-1242	42	2 1/2	1 3/4	2 3/32	1 1/16	1 1/2	1 5/8	1 21/32
JHWHM-1246	46	3 1/8	1 3/4	2 7/16	1 3/16	1 31/32	1 13/32	1 11/16
JHWHM-1250	50	3	1 3/4	2 5/8	1 5/16	2 3/32	1 13/32	1 13/32
JHWHM-1254	54	3 1/4	1 3/4	2 7/8	1 15/32	2 1/8	1 13/32	1 21/32
JHWHM-1255	55	3 1/4	1 3/4	2 29/32	1 15/32	2 1/8	1 13/32	1 21/32
JHWHM-1260	60	3 5/8	1 3/4	3 1/4	1 3/4	2 23/32	1 3/4	2 1/8

Fed. Spec: ANSI B107.110

JHWMSH-15RC 15 Piece 3/4" Drive Shallow 12 Point Socket Set on Clip Rail

Contents Include:

Product Code	Size (MM)	Product Code	Size (MM)	Product Code	Size (MM)
JHWHM-1219	19	JHWHM-1230	30	JHWHM-1238	38
JHWHM-1222	22	JHWHM-1232	32	JHWHM-1241	41
JHWHM-1224	24	JHWHM-1235	35	JHWHM-1246	46
JHWHM-1227	27	JHWHM-1236	36	JHWHM-1250	50
				JHWHM-1254	54
				JHWHM-1255	55
				JHWHM-1260	60

Features

- SUPERTORQUE™ lobular openings for greater turning power without deforming the fastener
- Designed for quick engagement on both 6 and 12 point fasteners



JHWHM-1232

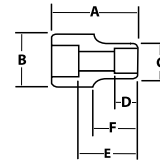

JHWMSH-15RC

3/4" DRIVE

SOCKETS AND DRIVE TOOLS





3/4" DRIVE IMPACT EXTENSIONS AND ACCESSORIES

Black Industrial Finish

Product Code	Description	Length (Inches)	Use RET RING®	Use O-Ring / Pin	Socket Retention
JHW38002	Impact Extension	7	JHW6-1XS	JHW6-1A / JHW6-2C	Through Hole and Pin
JHW38003	Impact Extension	10	JHW6-1XS	JHW6-1A / JHW6-2C	Through Hole and Pin
JHW38004	Impact Extension	13	JHW6-1XS	JHW6-1A / JHW6-2C	Through Hole and Pin
JHW38001	Impact Universal Joint	4 5/16	JHW6-1XS	JHW6-1A / JHW6-2C	Through Hole and Pin
JHW38005	1/2" M x 3/4" F Adapter	2 3/16	JHW6-1XS	JHW6-1A / JHW6-2C	Ball and Spring
JHW38006	1" M x 3/4" F Adapter	2 7/16	JHW6-1XS	JHW6-1A / JHW6-2C	Through Hole and Pin

Fed. Spec: ANSI B107.2

Features

- Specially heat treated for impact use to provide long life, safety, and durability
- Pin and o-ring or RET RING® (sold separately) secure tools onto impact wrench for safety and convenience
- Suitable for use with pneumatic and electric impact wrenches
- Drive end features pin retention hole and groove

3/4" DRIVE IMPACT RETAINING PINS AND RINGS

Black Industrial Finish

Product Code	Description	Diameter	Length	Application
JHW6-1A	Impact Retaining O-Ring	1 1/4	NA	Fits All Williams 3/4" Drive Sockets and Accessories
JHW6-2B	Impact Retaining Pin	3/16	1 1/4	Fits Williams Impact Sockets with "B" Dimension to 1 3/4"
JHW6-2C	Impact Retaining Pin	3/16	1 1/2	Fits Williams Impact Sockets with "B" Dimension 1 3/4" and Greater

Features

- Specially heat treated for impact use to provide long life, safety, and durability
- Suitable for use with pneumatic and electric impact wrenches
- For 3/4" drive impact tools with pin retention hole and groove



Made in U.S.A.



3/4" DRIVE RET RING® ONE-PIECE IMPACT RETAINING RINGS WITH CRUSH GAUGE

Black Industrial Finish

Product Code	Inside Dia. (In.)
JHW6-0XS	1 1/4"
JHW6-1XS	1 7/16"
JHW6-2XS	1 5/8"
JHW6-3XS	1 3/4"
JHW6-4XS	2
JHW6-5XS	2 1/8"
JHW6-6XS	2 1/4"

Features

- Fits all Williams 3/4" Drive Sockets and Accessories
- Crush Gauge on the resin pin indicates when a socket is excessively worn and should be replaced
- Securely retains sockets and accessories to square drive of impact wrench
- For 3/4" drive impact tools with pin retention hole and groove
- Made of oil resistant material
- RET RING® is a trademark of FTL Enterprises, Inc.



Made in U.S.A.



3/4" DRIVE BUDD® WHEEL IMPACT SOCKET, 6 POINT, SAE



Black Industrial Finish

Product Code	Size (Inches)	A (Inches)	B (Inches)	C (Inches)	D (Inches)	E (Inches)	Uses RET RING®	Use O-Ring / Pin
JHW16-648BW	1 3/16 Square & 1 1/2 Hex	4	1 3/4	2 1/4	1 7/16	2 1/4	6-1X	6-1A / 6-2C

Fed. Spec: ANSI B107.2

Features

- SUPERTORQUE™ lobular openings for greater turning power without deforming the fastener
- 13/16" square opening threads opening stud into wheel
- 1-1/2" hex opening engages and tightens the wheel lug nut
- Suitable for use with pneumatic and electric impact wrenches
- Specially heat treated for impact use to provide long life, safety, and durability



Made in U.S.A.





3/4" DRIVE SHALLOW IMPACT SOCKETS, 6 POINT, SAE

Black Industrial Finish



Product Code	Size (Inches)	A OAL (Inches)	B Drive End Diameter (Inches)	C Working End Diameter (Inches)	D Broach Depth (Inches)	E Bolt Clearance Depth (Inches)	F Bolt Clearance Diameter (Inches)	Nose Length (Inches)	Uses RET RING® Number	Use O-Ring / Pin
JHW6-618A	9/16	2	1 5/8	1	17/32	1 1/32	1/2	1	JHW6-1XS	JHW6-1A / JHW6-2B
JHW6-620A	5/8	2	1 5/8	1 3/32	17/32	1 1/32	1/2	1	JHW6-1XS	JHW6-1A / JHW6-2B
JHW6-622A	11/16	2	1 5/8	1 5/32	17/32	1 1/32	1/2	1	JHW6-1XS	JHW6-1A / JHW6-2B
JHW6-624A	3/4	2	1 5/8	1 1/4	17/32	1 1/32	11/16	1	JHW6-1XS	JHW6-1A / JHW6-2B
JHW6-626A	13/16	2	1 5/8	1 3/8	17/32	1 1/32	11/16	1	JHW6-1XS	JHW6-1A / JHW6-2B
JHW6-628A	7/8	2	1 5/8	1 1/2	19/32	1 1/32	11/16	1	JHW6-1XS	JHW6-1A / JHW6-2B
JHW6-630A	15/16	2	1 5/8	1 5/8	21/32	1 1/32	11/16	1	JHW6-1XS	JHW6-1A / JHW6-2B
JHW6-632A	1	2	1 5/8	1 5/8	11/16	1 1/32	11/16	-	JHW6-1XS	JHW6-1A / JHW6-2B
JHW6-634A	1 1/16	2	1 5/8	1 11/16	3/4	1 1/32	1 1/16	1 5/16	JHW6-1XS	JHW6-1A / JHW6-2B
JHW6-636	1 1/8	2 1/8	1 5/8	1 3/4	3/4	1 1/32	1 1/8	1 7/16	JHW6-1XS	JHW6-1A / JHW6-2B
JHW6-638	1 1/4	2 1/4	1 5/8	1 7/8	3/4	1 1/32	1 3/16	1 7/16	JHW6-1XS	JHW6-1A / JHW6-2B
JHW6-640	1 1/4	2 1/8	1 3/4	2	13/16	1 5/32	1 1/4	1 7/16	JHW6-1XS	JHW6-1A / JHW6-2C
JHW6-642	1 3/8	2 1/8	1 3/4	2 1/32	7/8	1 5/32	1 3/16	1 7/16	JHW6-1XS	JHW6-1A / JHW6-2C
JHW6-644	1 3/8	2 1/4	1 3/4	2 1/8	7/8	1 5/32	1 3/16	1 9/16	JHW6-1XS	JHW6-1A / JHW6-2C
JHW6-646	1 7/16	2 1/4	1 3/4	2 3/16	7/8	1 5/32	1 7/16	1 9/16	JHW6-1XS	JHW6-1A / JHW6-2C
JHW6-648	1 1/2	2 1/4	1 3/4	2 1/4	15/16	1 5/32	1 1/2	1 9/16	JHW6-1XS	JHW6-1A / JHW6-2C
JHW6-650	1 5/8	2 3/8	1 3/4	2 1/2	15/16	1 13/32	1 5/8	1 11/16	JHW6-1XS	JHW6-1A / JHW6-2C
JHW6-652	1 5/8	2 3/8	1 3/4	2 13/32	1	1 13/32	1 5/8	1 11/16	JHW6-1XS	JHW6-1A / JHW6-2C
JHW6-654	1 11/16	2 9/16	1 3/4	2 15/32	1 1/32	1 13/32	1 7/16	1 7/8	JHW6-1XS	JHW6-1A / JHW6-2C
JHW6-656	1 3/4	2 9/16	1 3/4	2 17/32	1 1/32	1 13/32	1 3/4	1 7/8	JHW6-1XS	JHW6-1A / JHW6-2C
JHW6-658	1 13/16	2 5/8	1 3/4	2 19/32	1 1/8	1 21/32	1 13/16	1 15/16	JHW6-1XS	JHW6-1A / JHW6-2C
JHW6-660	1 7/8	2 3/4	1 3/4	2 5/8	1 1/8	1 19/16	1 7/16	2 1/16	JHW6-1XS	JHW6-1A / JHW6-2C
JHW6-662	1 15/16	2 3/4	1 3/4	2 3/4	1 1/8	1 7/8	1 7/16	2 1/16	JHW6-1XS	JHW6-1A / JHW6-2C
JHW6-664	2	2 7/8	1 3/4	2 13/16	1 1/8	1 13/16	1 7/16	2 3/16	JHW6-1XS	JHW6-1A / JHW6-2C
JHW6-666	2 1/16	2 7/8	1 3/4	2 7/8	1 3/16	1 13/16	1 7/16	2 3/16	JHW6-1XS	JHW6-1A / JHW6-2C
JHW6-670	2 3/16	3 3/16	1 3/4	3 1/16	1 5/16	1 13/16	2 3/16	2 1/2	JHW6-1XS	JHW6-1A / JHW6-2C
JHW6-672	2 1/4	3 3/16	1 3/4	3 1/8	1 3/8	2 5/32	1 27/32	2 1/2	JHW6-1XS	JHW6-1A / JHW6-2C
JHW6-676	2 3/8	3 1/2	1 3/4	3 1/4	1 7/16	2 1/16	1 27/32	2 19/16	JHW6-1XS	JHW6-1A / JHW6-2C

Fed. Spec: ANSI B107.2

JHWWS-6-10HA 10 Piece 3/4" Drive Shallow 6 Point Impact Socket Set on Clip Rail

Product Code	Size (Inches)	Product Code	Size (Inches)	Product Code	Size (Inches)
JHW6-654	1 11/16	JHW6-660	1 7/8	JHW6-666	2 1/16
JHW6-656	1 3/4	JHW6-662	1 15/16	JHW6-670	2 3/16
JHW6-658	1 13/16	JHW6-664	2	JHW6-672	2 1/4
				JHW6-676	2 3/8

JHWWS-6-14HA 14 Piece 3/4" Drive Shallow 6 Point Impact Socket Set on Clip Rail

Product Code	Size (Inches)	Product Code	Size (Inches)	Product Code	Size (Inches)	Product Code	Size (Inches)
JHW6-624A	3/4	JHW6-632A	1	JHW6-640	1 1/4	JHW6-648	1 1/2
JHW6-626A	13/16	JHW6-634A	1 1/16	JHW6-642	1 5/16	JHW6-652	1 5/8
JHW6-628A	7/8	JHW6-636	1 1/8	JHW6-644	1 3/8		
JHW6-630A	15/16	JHW6-638	1 3/16	JHW6-646	1 7/16		

JHWWS-6-18TB 18 Piece 3/4" Drive Shallow 6 Point Impact Socket Set packed in Tool Box

Product Code	Size (Inches)	Product Code	Size (Inches)	Product Code	Size (Inches)
JHW6-628A	7/8	JHW6-640	1 1/4	6-656	1 3/4
JHW6-630A	15/16	JHW6-642	1 5/16	6-658	1 13/16
JHW6-632A	1"	JHW6-644	1 3/8	6-660	1 7/8
JHW6-634A	1 1/16	JHW6-646	1 7/16	6-664	2"
JHW6-636	1 1/8	JHW6-648	1 1/2	6-107	7" EXT
JHW6-638	1 3/16	JHW6-652	1 5/8	6-140B	U-JOINT
				JHW6-6119B	TOOL BOX

Features

- SUPERTORQUE™ lobular openings for greater turning power without deforming the fastener
- Designed for maximum engagement on 6 point fasteners
- Suitable for use with pneumatic and electric impact wrenches
- Specially heat treated for impact use to provide long life, safety, and durability



JHW6-620A



JHWWS-6-14HA



JHWWS-6-18TB

3/4" DRIVE

SOCKETS AND DRIVE TOOLS



TOOLS @ HEIGHT
DROP PREVENTION SYSTEM

Side hole in socket permits use with Snap-on Industrial Brands Tools@Height drive tools such as ratchets, extensions and u-joints

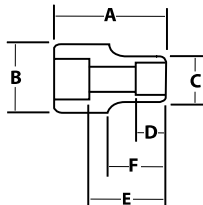

3/4" DRIVE SHALLOW IMPACT SOCKETS, 12 POINT, SAE



Black Industrial Finish

Product Code	Size (Inches)	Overall Length (Inches)	Drive End Diameter (Inches)	Working End Diameter (Inches)	Broach Depth (Inches)	Bolt Clearance Depth (Inches)	Bolt Clearance Diameter (Inches)	Nose Length (Inches)
JHW38420	5/8	2	1 1/2	1 1/8	5/8	/	1/2	7/8
JHW38422	1 1/16	2	1 1/2	1 1/8	5/8	/	1/2	7/8
JHW38424	3/4	2	1 1/2	1 1/8	5/8	/	5/8	7/8
JHW38426	13/16	2 1/16	1 1/2	1 1/4	3/4	/	3/4	15/16
JHW38428	7/8	2 1/16	1 1/2	1 3/16	3/4	/	3/4	15/16
JHW38430	15/16	2 1/16	1 1/2	1 7/16	3/4	/	7/8	15/16
JHW38432	1	2 1/16	1 1/2	1 1/2	3/4	/	7/8	/
JHW38434	1 1/16	2 1/16	1 1/2	1 1/2	3/4	/	15/16	/
JHW38436	1 1/8	2 1/16	1 5/8	1 5/8	3/4	/	1 1/16	/
JHW38438	1 3/16	2 1/16	1 3/4	1 3/4	3/4	/	1 1/16	/
JHW38440	1 1/4	2 1/16	1 3/4	1 13/16	3/4	/	1 3/16	15/16
JHW38442	1 5/16	2 1/4	1 3/4	1 13/16	7/8	/	1 3/16	15/16
JHW38444	1 3/8	2 1/4	1 3/4	2	7/8	/	1 1/4	15/16
JHW38446	1 7/16	2 1/4	1 3/4	2	7/8	/	1 3/8	15/16
JHW38448	1 1/2	2 1/4	1 3/4	2 1/16	15/16	/	1 3/8	15/16
JHW38450	1 9/16	2 7/16	1 3/4	2 1/4	15/16	/	1 1/2	1
JHW38452	1 5/8	2 7/16	1 3/4	2 1/4	15/16	/	/	1
JHW38454	1 11/16	2 7/16	1 3/4	2 1/2	1 1/16	/	/	1
JHW38456	1 3/4	2 7/16	1 3/4	2 1/2	1 1/16	/	/	1
JHW38458	1 13/16	2 5/8	1 3/4	2 5/8	1 1/16	/	/	1
JHW38460	1 7/8	2 5/8	1 3/4	2 5/8	1 1/16	/	/	1
JHW38462	1 15/16	2 3/4	1 3/4	2 3/4	1 5/16	/	/	1
JHW38464	2	2 13/16	2 1/8	2 3/4	1 5/16	/	/	1
JHW38466	2 1/16	2 13/16	2 1/8	3	1 5/16	/	/	1
JHW38468	2 1/8	2 13/16	2 1/8	3	1 5/16	/	/	1
JHW38476	2 3/8	3	2 1/8	3 5/16	1 1/2	/	/	1 1/16

JHW38925

9 piece 3/4" Drive Impact Shallow 12 Point, SAE Socket Set on Clip Rails

Contents Include:

Product Code	Size (Inches)	Product Code	Size (Inches)	Product Code	Size (Inches)
JHW38420	5/8	JHW38426	13/16	JHW38432	1
JHW38422	1 1/16	JHW38428	7/8	JHW38434	1 1/16
JHW38424	3/4	JHW38430	15/16	JHW38436	1 1/8



JHW38925

JHW38926

17 piece 3/4" Drive Impact Shallow 12 Point, SAE Socket Set on Clip Rails

Contents Include:

Product Code	Size (Inches)	Product Code	Size (Inches)	Product Code	Size (Inches)	Product Code	Size (Inches)
JHW38438	1 3/16	JHW38446	1 7/16	JHW38454	1 11/16	JHW38462	1 15/16
JHW38440	1 1/4	JHW38448	1 1/2	JHW38456	1 3/4	JHW38464	2
JHW38442	1 5/16	JHW38450	1 9/16	JHW38458	1 13/16	JHW38466	2 1/16
JHW38444	1 3/8	JHW38452	1 5/8	JHW38460	1 7/8	JHW38468	2 1/8
						JHW38476	2 3/8

Features

- SUPERTORQUE™ lobular openings for greater turning power without deforming the fastener
- Designed for maximum engagement on 6 or 12 point fasteners
- Suitable for use with pneumatic and electric impact wrenches
- Specially heat treated for impact use to provide long life, safety, and durability

3/4" DRIVE

SOCKETS AND
DRIVE TOOLS



3/4" DRIVE DEEP IMPACT SOCKETS, 6 POINT, SAE

Black Industrial Finish

Product Code	Size (Inches)	A OAL (Inches)	B Drive End Diameter (Inches)	C Working End Diameter (Inches)	D Broach Depth (Inches)	E Bolt Clearance Depth (Inches)	F Bolt Clearance Diameter (Inches)	Nose Length (Inches)	Uses RET RING® Number	Use O-Ring / Pin
JHW16-624	3/4	3	1 5/8	1 1/4	9/16	2 1/32	9/16	3/4	JHW6-1XS	JHW6-1A / JHW6-2B
JHW16-626	13/16	3	1 5/8	1 7/16	5/8	2 1/32	9/16	3/4	JHW6-1XS	JHW6-1A / JHW6-2B
JHW16-628	7/8	3	1 5/8	1 7/16	5/8	2 1/32	5/8	3/4	JHW6-1XS	JHW6-1A / JHW6-2B
JHW16-630	15/16	3	1 5/8	1 5/8	5/8	2 1/32	5/8	-	JHW6-1XS	JHW6-1A / JHW6-2B
JHW16-632	1	3	1 5/8	1 5/8	11/16	2 1/32	21/32	-	JHW6-1XS	JHW6-1A / JHW6-2B
JHW16-634	1 1/16	3	1 5/8	1 11/16	11/16	2 1/32	3/4	2 9/16	JHW6-1XS	JHW6-1A / JHW6-2B
JHW16-636	1 1/8	3	1 5/8	1 3/4	3/4	2 1/32	13/16	2 9/16	JHW6-1XS	JHW6-1A / JHW6-2B
JHW16-638	1 3/16	3 3/16	1 3/4	1 15/16	3/4	2 7/32	1 3/16	2 1/2	JHW6-1XS	JHW6-1A / JHW6-2C
JHW16-640	1 1/4	3 1/4	1 3/4	1 15/16	7/8	2 9/32	1 1/4	2 9/16	JHW6-1XS	JHW6-1A / JHW6-2C
JHW16-642	1 5/16	3 1/4	1 3/4	2	7/8	2 9/32	1 9/32	2 9/16	JHW6-1XS	JHW6-1A / JHW6-2C
JHW16-644	1 3/8	3 1/4	1 3/4	2 1/8	7/8	2 9/32	1 3/8	2 9/16	JHW6-1XS	JHW6-1A / JHW6-2C
JHW16-646	1 7/16	3 1/2	1 3/4	2 1/8	7/8	2 17/32	1 19/32	2 13/16	JHW6-1XS	JHW6-1A / JHW6-2C
JHW16-648	1 1/2	3 1/2	1 3/4	2 1/4	15/16	2 17/32	1 1/2	2 13/16	JHW6-1XS	JHW6-1A / JHW6-2C
JHW16-650	1 9/16	3 1/2	1 3/4	2 3/8	15/16	2 17/32	1 9/16	2 13/16	JHW6-1XS	JHW6-1A / JHW6-2C
JHW16-652	1 5/8	3 1/2	1 3/4	2 7/16	15/16	2 17/32	1 5/8	2 13/16	JHW6-1XS	JHW6-1A / JHW6-2C
JHW16-654	1 11/16	3 1/2	1 3/4	2 1/2	1	2 17/32	1 11/16	2 13/16	JHW6-1XS	JHW6-1A / JHW6-2C
JHW16-656	1 3/4	3 1/2	1 3/4	2 1/2	1	2 17/32	1 3/4	2 13/16	JHW6-1XS	JHW6-1A / JHW6-2C
JHW16-658	1 13/16	3 3/4	1 3/4	2 5/8	1 1/16	2 3/4	1 13/16	2 25/32	JHW6-1XS	JHW6-1A / JHW6-2C
JHW16-660	1 7/8	3 3/4	1 3/4	2 11/16	1 1/8	2 3/4	1 7/8	2 25/32	JHW6-1XS	JHW6-1A / JHW6-2C
JHW16-664	2	3 3/4	1 3/4	2 3/16	1 1/8	2 3/4	2	2 25/32	JHW6-1XS	JHW6-1A / JHW6-2C

Fed. Spec: ANSI B107.2

JHWWS-16-7H

7 Piece 3/4" Drive Impact Deep 6 Point Socket Set on Clip Rail

Contents Include:

Product Code	Size (Inches)	Product Code	Size (Inches)
JHW16-650	1 9/16	JHW16-658	1 13/16
JHW16-652	1 5/8	JHW16-660	1 7/8
JHW16-654	1 11/16	JHW16-664	2
JHW16-656	1 3/4		

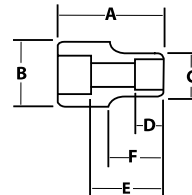

Drop Prevention System

Side hole in socket permits use with Snap-on Industrial Brands Tools@Height drive tools such as ratchets, extensions and u-joints

JHWWS-16-8H

8 Piece 3/4" Drive Deep 6 Point Impact Socket Set on Clip Rail

Contents Include:

Product Code	Size (Inches)	Product Code	Size (Inches)
JHW16-628	7/8	JHW16-636	1 1/8
JHW16-630	15/16	JHW16-640	1 1/4
JHW16-632	1	JHW16-642	1 3/16
JHW16-634	1 1/16	JHW16-648	1 1/2

Features

- SUPERTORQUE™ lobular openings for greater turning power without deforming the fastener
- Designed for maximum engagement on 6 point fasteners
- Suitable for use with pneumatic and electric impact wrenches
- Specially heat treated for impact use to provide long life, safety, and durability



JHW16-624

JHW16-632



JHWWS-16-8H

3/4" DRIVE

SOCKETS AND DRIVE TOOLS





TOOLS @ HEIGHT
DROP PREVENTION SYSTEM

Side hole in socket permits use with Snap-on Industrial Brands Tools@Height drive tools such as ratchets, extensions and u-joints

3/4" DRIVE SHALLOW IMPACT SOCKETS, 12 POINT, METRIC

Black Industrial Finish



JHW6M-1250



JHW6M-1219

Product Code	Size (MM)	A OAL (Inches)	B Drive End Diameter (Inches)	C Working End Diameter (Inches)	D Broach Depth (Inches)	E Bolt Clearance Depth (Inches)	F Bolt Clearance Diameter (Inches)	Nose Length (Inches)	Uses RET RING® Number	Use O-Ring / Pin
JHW6M-1219	19	2	1 5/8	1 1/4	1/2	1	3/8	1	JHW6-1XS	JHW6-1A/JHW6-2B
JHW6M-1220	20	2	1 5/8	1 3/8	1/2	1	3/8	1	JHW6-1XS	JHW6-1A/JHW6-2B
JHW6M-1221	21	2	1 5/8	1 3/8	1/2	1	3/8	1	JHW6-1XS	JHW6-1A/JHW6-2B
JHW6M-1222	22	2	1 5/8	1 1/2	1/2	1	3/8	1	JHW6-1XS	JHW6-1A/JHW6-2B
JHW6M-1223	23	2	1 5/8	1 1/2	3/8	1	3/8	1	JHW6-1XS	JHW6-1A/JHW6-2B
JHW6M-1224	24	2	1 5/8	1 1/2	5/8	1	3/4	1	JHW6-1XS	JHW6-1A/JHW6-2B
JHW6M-1225	25	2	1 5/8	1 1/2	11/16	1	3/4	1	JHW6-1XS	JHW6-1A/JHW6-2B
JHW6M-1226	26	2	1 5/8	1 1/2	11/16	1	3/4	1	JHW6-1XS	JHW6-1A/JHW6-2B
JHW6M-1227	27	2	1 5/8	1 5/8	11/16	1	1	-	JHW6-1XS	JHW6-1A/JHW6-2B
JHW6M-1228	28	2 1/4	1 5/8	1 3/4	11/16	1 3/8	1	-	JHW6-1XS	JHW6-1A/JHW6-2B
JHW6M-1229	29	2 1/4	1 5/8	1 3/4	11/16	1 3/8	1	-	JHW6-1XS	JHW6-1A/JHW6-2B
JHW6M-1230	30	2 1/4	1 5/8	1 3/4	3/4	1 3/8	1	-	JHW6-1XS	JHW6-1A/JHW6-2B
JHW6M-1231	31	2 1/4	1 5/8	2	3/4	1 1/4	1 1/4	-	JHW6-1XS	JHW6-1A/JHW6-2B
JHW6M-1232	32	2 1/4	1 3/4	2	13/16	1 1/4	1 1/4	-	JHW6-1XS	JHW6-1A/JHW6-2C
JHW6M-1233	33	2 1/4	1 3/4	2	13/16	1 1/4	1 1/4	-	JHW6-1XS	JHW6-1A/JHW6-2C
JHW6M-1234	34	2 1/4	1 3/4	2	7/8	1 1/4	1 1/4	-	JHW6-1XS	JHW6-1A/JHW6-2C
JHW6M-1235	35	2 1/4	1 3/4	2 1/8	7/8	1 1/4	1 1/4	-	JHW6-1XS	JHW6-1A/JHW6-2C
JHW6M-1236	36	2 1/4	1 3/4	2 1/8	7/8	1 1/4	1 1/2	-	JHW6-1XS	JHW6-1A/JHW6-2C
JHW6M-1238	38	2 1/4	1 3/4	2 3/16	1	1 1/4	1 1/2	-	JHW6-1XS	JHW6-1A/JHW6-2C
JHW6M-1240	40	2 1/2	1 3/4	2 3/8	1 1/8	1 7/16	1 1/2	-	JHW6-1XS	JHW6-1A/JHW6-2C
JHW6M-1241	41	2 1/2	1 3/4	2 3/8	1 1/8	1 7/16	1 1/2	-	JHW6-1XS	JHW6-1A/JHW6-2C
JHW6M-1242	42	2 1/2	1 3/4	2 3/8	1 1/8	1 3/8	1 1/2	-	JHW6-1XS	JHW6-1A/JHW6-2C
JHW6M-1243	43	2 1/2	1 3/4	2 1/2	1 1/8	1 3/8	1 3/4	-	JHW6-1XS	JHW6-1A/JHW6-2C
JHW6M-1244	44	2 1/2	1 3/4	2 1/2	1 1/8	1 3/8	1 3/4	-	JHW6-1XS	JHW6-1A/JHW6-2C
JHW6M-1246	46	2 3/4	1 3/4	2 5/8	1 1/8	1 1/2	1 3/4	-	JHW6-1XS	JHW6-1A/JHW6-2C
JHW6M-1250	50	2 3/4	1 3/4	2 5/8	1 1/8	1 1/2	2	-	JHW6-1XS	JHW6-1A/JHW6-2C



JHW6M-617A

3/4" DRIVE SHALLOW IMPACT SOCKETS, 6 POINT, METRIC

Black Industrial Finish

Product Code	Size (MM)	A OAL (Inches)	B Drive End Diameter (Inches)	C Working End Diameter (Inches)	D Broach Depth (Inches)	E Bolt Clearance Depth (Inches)	F Bolt Clearance Diameter (Inches)	Nose Length (Inches)	Uses RET RING® Number	Use O-Ring / Pin
JHW6M-617A	17	2	1 5/8	1 3/32	17/32	1 1/32	1/2	1	JHW6-1XS	JHW6-1A / JHW6-2B
JHW6M-619A	19	2	1 5/8	1 1/4	17/32	1 1/32	11/16	1	JHW6-1XS	JHW6-1A / JHW6-2B
JHW6M-620A	20	2	1 5/8	1 3/8	35/64	1 1/32	11/16	1	JHW6-1XS	JHW6-1A / JHW6-2B
JHW6M-622A	22	2	1 5/8	1 1/2	19/32	1 1/32	11/16	1	JHW6-1XS	JHW6-1A / JHW6-2B
JHW6M-624A	24	2	1 5/8	1 35/64	11/32	1 1/32	11/16	1	JHW6-1XS	JHW6-1A / JHW6-2B
JHW6M-627A	27	2	1 5/8	1 11/16	3/4	1 1/32	1 1/16	1 5/16	JHW6-1XS	JHW6-1A / JHW6-2B
JHW6M-630	30	2 3/32	1 5/8	1 27/32	47/64	1 1/8	47/64	1 13/32	JHW6-1XS	JHW6-1A / JHW6-2B
JHW6M-631	31	2 1/8	1 5/8	1 15/16	3/4	1 3/16	1 7/32	1 7/16	JHW6-1XS	JHW6-1A / JHW6-2B
JHW6M-632	32	2 1/8	1 3/4	2	19/16	1 3/16	1 1/4	1 7/16	JHW6-1XS	JHW6-1A / JHW6-2C
JHW6M-634	34	2 1/8	1 3/4	2	7/8	1 3/16	1 21/64	1 7/16	JHW6-1XS	JHW6-1A / JHW6-2C
JHW6M-635	35	2 1/4	1 3/4	2 1/8	7/8	1 5/16	1 3/8	1 9/16	JHW6-1XS	JHW6-1A / JHW6-2C
JHW6M-636	36	2 1/4	1 3/4	2 1/8	7/8	1 5/16	1 13/32	1 9/16	JHW6-1XS	JHW6-1A / JHW6-2C
JHW6M-638	38	2 1/4	1 3/4	2 1/4	15/16	1 5/16	1 1/2	1 9/16	JHW6-1XS	JHW6-1A / JHW6-2C
JHW6M-641	41	2 5/8	1 3/4	2 13/32	1 1/8	1 11/16	1 39/64	1 15/16	JHW6-1XS	JHW6-1A / JHW6-2C
JHW6M-646	46	2 5/8	1 3/4	2 19/32	1 1/8	1 21/32	1 19/16	1 15/16	JHW6-1XS	JHW6-1A / JHW6-2C

JHWMS-6-8H 8 Piece 3/4" Drive Shallow 6 Point Impact Socket Set on Clip Rail

Contents Include:

Product Code	Size (MM)	Product Code	Size (MM)	Product Code	Size (MM)
JHW6M-619A	19	JHW6M-627A	27	JHW6M-636	36
JHW6M-622A	22	JHW6M-630	30	JHW6M-641	41
JHW6M-624A	24	JHW6M-632	32		



Features

- SUPERTORQUE™ lobular openings for greater turning power without deforming the fastener
- Designed for maximum engagement on 6 and 12 point fasteners
- Suitable for use with pneumatic and electric impact wrenches
- Specially heat treated for impact use to provide long life, safety, and durability
- Drive end features pin retention hole and groove

3/4" DRIVE

SOCKETS AND DRIVE TOOLS

3/4" DRIVE ONE PIECE IMPACT HEX BIT DRIVER, SAE



Black Industrial Finish

Product Code	Hex Size (Inches)	A		B		F		Uses RET RING® Number	Use O-Ring / Pin
		OAL	Drive End Diameter	Nose Length					
JHW38216	1/2	3 1/2	1 3/4	3/4			JHW6-1XS	JHW6-1A / JHW6-2C	
JHW38218	9/16	3 1/2	1 3/4	3/4			JHW6-1XS	JHW6-1A / JHW6-2C	
JHW38220	5/8	3 1/2	1 3/4	3/4			JHW6-1XS	JHW6-1A / JHW6-2C	
JHW38224	3/4	3 1/2	1 3/4	3/4			JHW6-1XS	JHW6-1A / JHW6-2C	
JHW38226	13/16	3 1/2	1 3/4	3/4			JHW6-1XS	JHW6-1A / JHW6-2C	
JHW38228	7/8	3 1/2	1 3/4	3/4			JHW6-1XS	JHW6-1A / JHW6-2C	
JHW38232	1	3 1/2	1 3/4	3/4			JHW6-1XS	JHW6-1A / JHW6-2C	
JHW38236	1 1/8	3 1/2	1 3/4	3/4			JHW6-1XS	JHW6-1A / JHW6-2C	
JHW38240	1 1/4	3 1/2	1 3/4	3/4			JHW6-1XS	JHW6-1A / JHW6-2C	

Side hole in socket permits use with Snap-on Industrial Brands Tools@Height drive tools such as ratchets, extensions and u-joints

JHW38932 5 Piece 3/4" Drive Hex-Driver Impact Socket Set on Clip Rail

Contents Include:

Product Code	Size (Inches)	Product Code	Size (Inches)
JHW38220	5/8	JHW38228	7/8
JHW38224	3/4	JHW38232	1
JHW38226	13/16		



JHW38903 9 Piece 3/4" Drive Hex-Driver Impact Socket Set with 50085 Metal Box

Contents Include:

Product Code	Size (Inches)	Product Code	Size (Inches)
JHW38216	1/2	JHW38228	7/8
JHW38218	9/16	JHW38232	1
JHW38220	5/8	JHW38236	1 1/8
JHW38224	3/4	JHW38240	1 1/4
JHW38226	13/16		



Features

- One-piece design maximizes strength and reduces breakage
- Chamfered ends provide easy engagement of the drive tool and fastener
- Suitable for use with pneumatic and electric impact wrenches
- Specially heat treated for impact use to provide long life, safety, and durability
- Drive end features pin retention hole and groove



3/4" DRIVE

SOCKETS AND DRIVE TOOLS



TOOLS@HEIGHT
DROP PREVENTION SYSTEM

Side hole in socket permits use with Snap-on Industrial Brands Tools@Height drive tools such as ratchets, extensions and u-joints

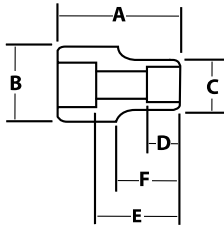

3/4" DRIVE ONE PIECE IMPACT HEX BIT DRIVER, METRIC



Black Industrial Finish

Product Code	Hex Size (MM)	Overall Length (Inches)	Drive End Diameter (Inches)	Nose Length	Uses RET Ring Number	use O-Ring/Pin
JHW35810	10	3 1/2	1 3/4	3/4	JHW6-1XS	JHW6-1A/JHW6-2C
JHW35812	12	3 1/2	1 3/4	3/4	JHW6-1XS	JHW6-1A/JHW6-2C
JHW35814	14	3 1/2	1 3/4	3/4	JHW6-1XS	JHW6-1A/JHW6-2C
JHW35817	17	3 1/2	1 3/4	3/4	JHW6-1XS	JHW6-1A/JHW6-2C
JHW35819	19	3 1/2	1 3/4	3/4	JHW6-1XS	JHW6-1A/JHW6-2C
JHW35821	21	3 1/2	1 3/4	3/4	JHW6-1XS	JHW6-1A/JHW6-2C
JHW35824	24	3 1/2	1 3/4	3/4	JHW6-1XS	JHW6-1A/JHW6-2C
JHW35827	27	3 1/2	1 3/4	3/4	JHW6-1XS	JHW6-1A/JHW6-2C
JHW35830	30	3 1/2	1 3/4	3/4	JHW6-1XS	JHW6-1A/JHW6-2C
JHW35832	32	3 1/2	1 3/4	3/4	JHW6-1XS	JHW6-1A/JHW6-2C

Fed. Spec: ANSI B107.2

JHW38936

10 Piece 3/4" Drive One Piece Impact Hex Bit Drivers, Metric

Contents Include:

Product Code	Size (MM)	Product Code	Size (MM)	Product Code	Size (MM)
JHW35810	10	JHW35819	19	JHW35830	30
JHW35812	12	JHW35821	21	JHW35832	32
JHW35814	14	JHW35824	24		
JHW35817	17	JHW35827	27		



JHW35830

JHW35812



JHW38936

3/4" DRIVE

SOCKETS AND DRIVE TOOLS

27 PIECE 1" DRIVE SOCKET AND DRIVE TOOL SET



12 Point SAE, with Metal Box

Product Code	Description
JHWWXSX-28TB	27 Piece Tool Set with JHWTB-12 Metal Tool Box
JHWWXSX-28	27 Piece Tool Set Only

Contents Include:

Drive Tools:		Shallow 12-Point Sockets	
Product Code	Description	Product Code	Size (Inches)
JHWX-20	20" Sliding T-Handle/Head	JHWX-1252	1 5/8
JHWX-41C	34 3/16" Flex Handle	JHWX-1258	1 13/16
JHWX-51B	20" Ratchet	JHWX-1260	1 7/8
JHWX-110	8" Extension	JHWX-1264	2
JHWX-115	16" Extension	JHWX-1268	2 1/8
		JHWX-1270	2 3/16
		JHWX-1272	2 1/4
		JHWX-1276	2 3/8
		JHWX-1280	2 1/2
		JHWX-1282	2 9/16
		JHWX-1284	2 5/8
		JHWX-1288	2 3/4
		JHWX-1294	2 15/16
		JHWX-1296	3
		JHWX-12100	3 1/8

Features

- All tools are professional quality, made of high-grade chrome vanadium steel
- Sockets feature SUPERTORQUE™ lobular openings for greater turning power without deforming the fastener
- Metal tool box made for years of rugged use



JHWWXSX-28TB

19 PIECE 1" DRIVE SOCKET AND DRIVE TOOL SET



12 Point SAE, with Metal Box

Product Code	Description
JHWWXSX-21TB	19 Piece Tool Set with JHWTB-12 Metal Tool Box
JHWWXSX-21	19 Piece Tool Set Only

Contents Include:

Drive Tools:		Shallow 12-Point Sockets	
Product Code	Description	Product Code	Size (Inches)
JHWX-20	20" Sliding T-Handle / Head	JHWX-1260	1 7/8
JHWX-41C	34 3/16" Flex Handle	JHWX-1264	2
JHWX-51B	20" Ratchet	JHWX-1270	2 3/16
JHWX-110	8" Extension	JHWX-1272	2 1/4
JHWX-115	16" Extension	JHWX-1276	2 3/8
		JHWX-1280	2 1/2
		JHWX-1282	2 9/16
		JHWX-1284	2 5/8
		JHWX-1288	2 3/4
		JHWX-1294	2 15/16
		JHWX-1296	3

Features

- All tools are professional quality, made of high-grade chrome vanadium steel
- Sockets feature SUPERTORQUE™ lobular openings for greater turning power without deforming the fastener
- Metal tool box made for years of rugged use



JHWWXSX-21TB

1" DRIVE

SOCKETS AND DRIVE TOOLS





JHWWXSX-20TB

19 PIECE 1" DRIVE SOCKET AND DRIVE TOOL SET



12 Point SAE, with Metal Box

Product Code	Description
JHWWXSX-20TB	19 Piece Tool Set with JHWTB-12 Metal Tool Box
JHWWXSX-20	19 Piece Tool Set Only

Contents Include:

Drive Tools:		Shallow 12-Point Sockets	
Product Code	Description	Product Code	Size (Inches)
JHWX-20	20" Sliding T-Handle/Head	JHWX-1242	1 5/16
JHWX-41C	34 3/16" Flex Handle	JHWX-1244	1 3/8
JHWX-51B	20" Ratchet	JHWX-1246	1 7/16
JHWX-110	8" Extension	JHWX-1248	1 1/2
JHWX-115	16" Extension	JHWX-1252	1 5/8
		JHWX-1258	1 13/16
		JHWX-1260	1 7/8
		JHWX-1264	2
Shallow 12-Point Sockets		JHWX-1270	2 3/16
Product Code	Size (Inches)	JHWX-1272	2 1/4
JHWX-1234	1 1/16	JHWX-1276	2 3/8
JHWX-1236	1 1/8		
JHWX-1240	1 1/4		

Features

- All tools are professional quality, made of high-grade chrome vanadium steel
- Sockets feature SUPERTORQUE™ lobular openings for greater turning power without deforming the fastener
- Metal tool box made for years of rugged use



Made in U.S.A.



JHWX-51B

1" DRIVE RATCHETS

Integrated Handle, Chrome Finish

Product Code	Description	Length (Inches)	Number of Teeth
JHWX-51B	Chrome Ratchet	20 1/2	24
JHWX-52EHRK	Repair Kit for JHWX-51B		

Fed. Spec: ANSI B107.10M

Features

- Forged one-piece ratchet provide strength and safety for industrial applications
- Smooth comfort-grip handle permits all-day use without gloves
- 24 tooth gear with 15 degree of engagement allows engagement in tight working areas
- Chrome finish with mirror-like exterior can be easily cleaned after each use
- Single Pawl ratchet design:
 - 1) Designed for tighter tolerances between pawl and gear which reduces metal fatigue and slippage under load
 - 2) Does not require as many working parts, reducing possible breakage and parts to repair
- Easy access reverse lever allows user to change working direction quickly and easily with only one hand
- Spring and plunger socket retention



Made in U.S.A.

1" DRIVE REMOVABLE-HANDLE RATCHETS

Knurled Handle, Chrome Finish

Complete Ratchet

Product Code	Description	Length (Inches)	Number of Teeth
JHWX-52A1	Ratchet with 36" Handle	41	24

Components

Product Code	Description	Length (Inches)	Number of Teeth
JHWX-52	Ratchet Head Only	7 15/16	24
JHWX-52H36	Handle Only	36	24
JHWX-52RK	Repair Kit		

Note: Head Bore and Handle End Diameter: 1-7/64"

Fed. Spec: ANSI B107.10M

Features

- 24 teeth action provides an 15° ratcheting angle
- Shift lever reverses action instantly
- Dual socket retention, with both ball and plunger on male drive for versatility
- Removable handle makes the tool more versatile, and storage easier
- Knurled handle provides a non-slip grip
- Chrome finish models provides increased protection from rust and corrosion
- Our most rugged, high torque capacity ratchet



Made in U.S.A.



JHWX-52



JHWX-52A1

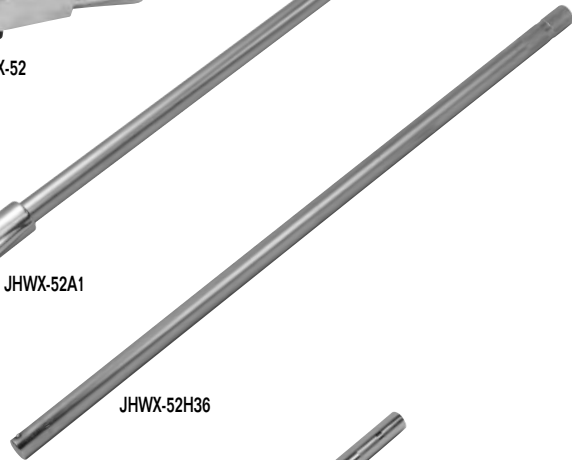

JHWX-52H36

1" DRIVE HANDLES

Chrome and Black Industrial Finish

Product Code	Description	Length (Inches)	Finish
JHWX-41C	Flex Handle Breaker Bar, Knurled Grip	34 3/16	Chrome
JHWX-41CB	Flex Handle Breaker Bar, Knurled Grip	34 3/16	Black Industrial
JHWX-20	Sliding T-Handle	20	Chrome

Sliding T-Handle Components

Product Code	Description	Length (Inches)	Finish
JHWX-20B	Handle	20	Chrome
JHWX-20C	Sliding Head	1 15/16	Chrome

Fed. Spec: ANSI B107.10M

Features

- Chrome plating provides increased protection from rust and corrosion
- Drive handles provide extra leverage with greater strength than ratchets
- Square drive slides on T-Handles for versatility
- Flex handle flex drive swivels 110° in either direction
- Spring and plunger socket retention



Made in U.S.A.



JHWX-41C



JHWX-41CB



JHWX-20

1" DRIVE EXTENSIONS

Chrome Finish

Product Code	Length (Inches)
JHWX-110	8
JHWX-115	16

Fed. Spec: ANSI B107.10M

Features

- Chrome plating provides increased protection from rust and corrosion
- Ball and spring socket retention
- Hole in wall of drive end accommodates plunger for firm tool retention



Made in U.S.A.



JHWX-110

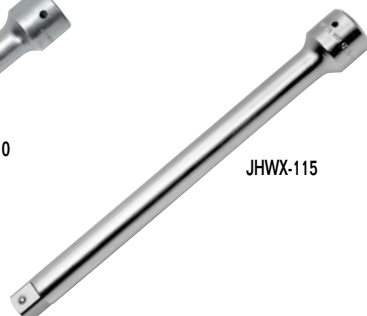

JHWX-115



1" DRIVE SHALLOW 12 POINT SOCKETS, SAE

High-Polished Chrome Finish



JHWX-1234 JHWX-1244



JHWSX-17

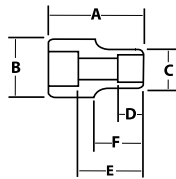

Product Code	Size (Inches)	A OAL (Inches)	B Drive End Diameter (Inches)	C Working End Diameter (Inches)	D Broach Depth (Inches)	E Bolt Clearance Depth (Inches)	F Bolt Clearance Diameter (Inches)	Nose Length (Inches)
JHWX-1234	1 1/16	2 1/4	2	1 5/8	3/4	1 1/16	13/16	7/8
JHWX-1236	1 1/8	2 1/4	2	1 3/4	3/4	1 1/16	13/16	7/8
JHWX-1240	1 1/4	2 3/8	2	1 7/8	3/4	1 1/8	13/16	7/8
JHWX-1242	1 5/16	2 1/2	2	2 1/16	13/16	1 9/32	15/16	1 1/16
JHWX-1244	1 3/8	2 1/2	2	2 1/8	7/8	1 11/32	1 13/32	1 9/16
JHWX-1246	1 7/16	2 3/4	2	2 3/16	1	1 15/32	1 1/2	1 11/16
JHWX-1248	1 1/2	2 3/4	2	2 1/4	1	1 19/32	1 9/16	1 13/16
JHWX-1252	1 5/8	2 7/8	2	2 3/8	1 1/8	1 3/4	1 11/16	1 15/16
JHWX-1254	1 11/16	2 7/8	2	2 3/8	1 3/16	1 9/16	1 3/4	1 15/16
JHWX-1256	1 3/4	3	2	2 9/16	1 1/4	1 27/32	1 13/16	2 1/16
JHWX-1258	1 13/16	3 1/8	2 1/8	2 3/8	1 1/4	1 31/32	1 7/16	2 3/16
JHWX-1260	1 7/8	3 1/4	2 1/8	2 3/4	1 7/16	2 3/32	1 7/16	2 5/16
JHWX-1264	2	3 3/8	2 1/8	2 15/16	1 1/2	2 1/4	1 7/16	2 7/16
JHWX-1268	2 1/8	3 1/2	2 1/4	3 1/8	1 1/2	2 11/32	1 7/16	2 9/16
JHWX-1270	2 3/16	3 5/8	2 1/4	3 1/8	1 17/32	2 15/32	2 1/4	2 11/16
JHWX-1272	2 1/4	3 3/4	2 1/4	3 1/4	1 5/8	2 5/8	2 11/32	2 23/32
JHWX-1276	2 3/8	3 7/8	2 1/4	3 3/8	1 5/8	2 3/4	2 3/8	2 13/16
JHWX-1280	2 1/2	4 1/8	2 1/4	3 1/2	1 3/4	2 31/32	2 1/2	3 1/16
JHWX-1282	2 9/16	4 1/8	2 1/4	3 1/16	1 13/16	2 31/32	2 9/16	3 3/16
JHWX-1284	2 5/8	4 1/4	2 1/4	3 5/8	1 7/8	3 3/32	2 5/8	3 1/8
JHWX-1288	2 3/4	4 1/2	2 1/4	3 3/4	2	3 3/8	2 3/4	3 9/16
JHWX-1294	2 15/16	4 27/32	2 1/4	4	2 1/8	3 23/32	2 15/16	3 25/32
JHWX-1296	3	4 7/8	2 1/4	4 1/8	2 1/8	3 3/4	3	3 27/32
JHWX-12100	3 1/8	4 31/32	2 1/4	4 1/4	2 1/8	3 27/32	3 1/8	3 29/32

Fed. Spec: ANSI B107.1

JHWSX-17 17 Piece 1" Drive Shallow 12-Point Socket Set

Contents Include:

Product Code	Size (Inches)	Product Code	Size (Inches)	Product Code	Size (Inches)
JHWX-1234	1 1/16	JHWX-1248	1 1/2	JHWX-1264	2
JHWX-1236	1 1/8	JHWX-1252	1 5/8	JHWX-1268	2 1/8
JHWX-1240	1 1/4	JHWX-1254	1 11/16	JHWX-1270	2 3/16
JHWX-1242	1 5/16	JHWX-1256	1 3/4	JHWX-1272	2 1/4
JHWX-1244	1 3/8	JHWX-1258	1 13/16	JHWX-1276	2 3/8
JHWX-1246	1 7/16	JHWX-1260	1 7/8		

Features

- SUPERTORQUE™ lobular openings for greater turning power without deforming the fastener
- Designed for quick engagement on both 6 and 12 point fasteners



Made in U.S.A.

1" DRIVE IMPACT EXTENSIONS AND ACCESSORIES

Black Industrial Finish

Product Code	Description	Length (Inches)	Use		Socket Retention
			RET RING®	O-Ring / Pin	
JHW7-107	Impact Extension	7 1/4	JHW7-2XS	JHW7-1B / JHW7-2D	Through Hole and Pin
JHW7-113	Impact Extension	13	JHW7-2XS	JHW7-1B / JHW7-2D	Through Hole and Pin
JHW7-140B	Impact Universal Joint	4 1/2	JHW7-3XS	JHW7-1B / JHW7-2D	Through Hole and Pin
JHW7-6	3/4"M x 1"F Adapter	3	JHW7-2XS	JHW7-1B / JHW7-2D	Through Hole and Pin
JHW7-8	1 1/2"M x 1"F Adapter	3 3/8	JHW7-2XS	JHW7-1B / JHW7-2D	Through Hole and Pin

Fed. Spec: ANSI B107.2

Features

- Specially heat treated for impact use to provide long life, safety, and durability
- Pin and o-ring or RET RING® (sold separately) secure tools onto impact wrench for safety and convenience
- Universal joint provides 55° range of motion
- Suitable for use with pneumatic and electric impact wrenches
- Drive end features pin retention hole and groove



Made in U.S.A.



JHW7-107



JHW7-140B



JHW7-8

1" DRIVE

SOCKETS AND
DRIVE TOOLS

1" DRIVE IMPACT RETAINING PINS AND RINGS

Product Code	Description	Diameter	Length	Application
JHW7-1B	Impact Retaining O-Ring	2	NA	Fits Williams Impact Tools with "B" Dimension to 2 3/8"
JHW7-2D	Impact Retaining Pin	3/16	1 3/4	Fits Williams Impact Tools with "B" Dimension to 2 3/8"
JHW7-1C	Impact Retaining O-Ring	3 1/4	NA	Fits Williams Impact Tools with "B" Dimension of 3 1/4"
JHW7-2F	Impact Retaining Pin	3/16	2 7/8	Fits Williams Impact Tools with "B" Dimension of 3 1/4"

Features

- Specially heat treated for impact use to provide long life, safety, and durability
- Suitable for use with pneumatic and electric impact wrenches
- For 1" Drive impact tools with pin retention hole and groove

1" DRIVE RET RING® ONE-PIECE IMPACT RETAINING RINGS WITH CRUSH GAUGE

Product Code	Groove Diameter (Inches)	Application
JHW7-1XS	1 3/4	Fits Competitive Impact Sockets
JHW7-2XS	2	Fits Williams 1" Drive Tools with "B" Dimension of 2 1/8" and 2 1/4"
JHW7-3XS	2 1/8	Fits Williams 1" Drive Tools with "B" Dimension of 2 3/8"
JHW7-4XS	2 1/4	Fits Competitive Impact Sockets
JHW7-5XS	2 1/2	Fits Competitive Impact Sockets
JHW7-6XS	2 5/8	Fits Competitive Impact Sockets

Features

- Fits all Williams 1" Drive Sockets and Accessories
- Crush Gauge on the resin pin indicates when a socket is excessively worn and should be replaced
- Securely retains sockets and accessories to square drive of impact wrench
- For 1" drive impact tools with pin retention hole and groove
- Made of oil resistant material
- RET RING® is a trademark of FTL Enterprises, Inc.



JHW7-1B

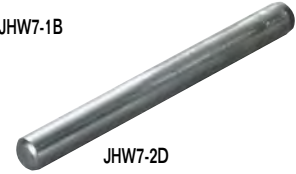

JHW7-2D



JHW7-1XS

1" DRIVE BUDD® WHEEL IMPACT SOCKET, 6 POINT, SAE



Black Industrial Finish

Product Code	Size (Inches)	A		B		C		D		E	
		OAL (Inches)	Drive End Diameter (Inches)	Working End Diameter (Inches)	Broach Depth (Inches)	Bolt Clearance Depth (Inches)	Bolt Clearance Diameter (Inches)				
JHW17-648BW	1 3/8 Square / 1 1/2 Hex	4	1 3/4	2 1/4	1 7/16	2 1/4	1 1/4				

Fed. Spec: ANSI B107.2

Features

- SUPERTORQUE™ lobular openings for greater turning power without deforming the fastener
- 13/16" square opening threads stud into wheel
- 1-1/2" hex opening engages and tightens the wheel lug nut
- Suitable for use with pneumatic and electric impact wrenches
- Specially heat treated for impact use to provide long life, safety, and durability



JHW17-648BW

19 PIECE 1" DRIVE IMPACT SOCKET SET

6 Point Shallow SAE Set in Tool Box

Product Code	Description
JHWWS-7-19TB	19 Piece 1" Drive Shallow 6 Point Impact Socket Set in Tool Box

Contents Include:

Product Code	Size (Inches)	Product Code	Size (Inches)	Product Code	Size (Inches)	Product Code	Size (Inches)
JHW7-648	1 1/2	JHW7-668	2 1/8	JHW7-684	2 5/8	JHW7-6104	3 1/4
JHW7-652	1 5/8	JHW7-672	2 1/4	JHW7-688	2 3/4	JHW7-6112	3 1/2
JHW7-656	1 3/4	JHW7-676	2 3/8	JHW7-692	2 7/8	JHW7-107	7 3/8" EXT
JHW7-660	1 7/8	JHW7-680	2 1/2	JHW7-696	3	JHW7-140B	U-Joint
JHW7-664	2	JHW7-682	2 9/16	JHW7-6100	3 1/8	JHW7B-6124B	Tool Box

Features

- SUPERTORQUE™ lobular openings for greater turning power without deforming the fastener
- Designed for maximum engagement on 6 point fasteners
- Suitable for use with pneumatic and electric impact wrenches
- Specially heat treated for impact use to provide long life, safety, and durability



JHWWS-7-19TB

1" DRIVE

SOCKETS AND DRIVE TOOLS



TOOLS@HEIGHT
 DROP PREVENTION SYSTEM
 Side hole in socket permits use with Snap-on Industrial Brands Tools@Height drive tools such as ratchets, extensions and u-joints

1" DRIVE SHALLOW IMPACT SOCKETS, 6 POINT, SAE

Black Industrial Finish



JHW7-654

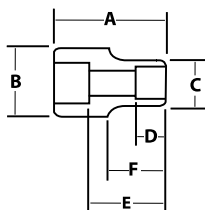

Product Code	Size (Inches)	OAL (Inches)	A	B	C	D	E	F	Nose Length (Inches)	Uses RET RING® Number	Use O-Ring / Pin
			Drive End Diameter (Inches)	Working End Diameter (Inches)	Broach Depth (Inches)	Bolt Clearance Depth (Inches)	Bolt Clearance Dia. (Inches)				
JHW7-624	3/4	2 1/8	2 1/8	1 7/16	1 1/16	1 1/16	1 1/16	3/4	7/8	JHW7-2XS	JHW7-1B / JHW7-2D
JHW7-626	13/16	2 1/8	2 1/8	1 7/16	1 1/16	1 1/16	1 1/16	3/4	7/8	JHW7-2XS	JHW7-1B / JHW7-2D
JHW7-628	7/8	2 1/8	2 1/8	1 1/2	1 1/16	1 1/16	1 1/16	3/4	7/8	JHW7-2XS	JHW7-1B / JHW7-2D
JHW7-630	15/16	2 1/8	2 1/8	1 19/32	5/8	1 1/16	1 1/16	3/4	7/8	JHW7-2XS	JHW7-1B / JHW7-2D
JHW7-632	1	2 1/4	2 1/8	1 11/16	1 1/16	1 1/16	1 1/16	3/4	7/8	JHW7-2XS	JHW7-1B / JHW7-2D
JHW7-634	1 1/16	2 1/4	2 1/8	1 3/4	1 1/16	1 1/16	1 1/16	3/4	7/8	JHW7-2XS	JHW7-1B / JHW7-2D
JHW7-636	1 1/8	2 1/4	2 1/8	1 7/8	1 1/16	1 1/16	1 1/16	13/16	7/8	JHW7-2XS	JHW7-1B / JHW7-2D
JHW7-638	1 3/16	2 1/4	2 1/8	1 7/8	1 1/16	1 1/16	1 1/16	13/16	7/8	JHW7-2XS	JHW7-1B / JHW7-2D
JHW7-640	1 1/4	2 3/8	2 1/8	2	3/4	1 3/16	1 3/16	15/16	7/8	JHW7-2XS	JHW7-1B / JHW7-2D
JHW7-642	1 5/16	2 1/2	2 1/8	2 1/16	7/8	1 5/16	1	1	1	JHW7-2XS	JHW7-1B / JHW7-2D
JHW7-644	1 3/8	2 1/2	2 1/8	2 1/8	7/8	1 5/16	1 3/8	-	-	JHW7-2XS	JHW7-1B / JHW7-2D
JHW7-646	1 7/16	2 1/2	2 1/4	2 1/4	29/32	1 5/16	1 7/16	-	-	JHW7-2XS	JHW7-1B / JHW7-2D
JHW7-648	1 1/2	2 5/8	2 1/4	2 11/32	15/16	1 15/32	1 1/2	1 5/8	1 1/2	JHW7-2XS	JHW7-1B / JHW7-2D
JHW7-650	1 9/16	2 5/8	2 1/4	2 3/8	15/16	1 7/16	1 9/16	1 5/8	1 5/8	JHW7-2XS	JHW7-1B / JHW7-2D
JHW7-652	1 5/8	2 3/4	2 1/4	2 3/8	1 1/16	1 5/8	1 19/32	1 3/4	1 3/4	JHW7-2XS	JHW7-1B / JHW7-2D
JHW7-654	1 11/16	2 3/4	2 1/8	2 19/32	1 1/16	1 5/8	1 7/32	1 3/4	1 3/4	JHW7-3XS	JHW7-1B / JHW7-2D
JHW7-656	1 3/4	2 7/8	2 3/8	2 5/8	1 5/32	1 23/32	1 7/16	1 7/8	1 7/8	JHW7-3XS	JHW7-1B / JHW7-2D
JHW7-658	1 13/16	2 15/16	2 3/8	2 3/4	1 3/16	1 23/32	1 13/16	1 15/16	1 15/16	JHW7-3XS	JHW7-1B / JHW7-2D
JHW7-660	1 7/8	2 15/16	2 3/8	2 3/4	1 3/16	1 23/32	1 7/16	1 15/16	1 15/16	JHW7-3XS	JHW7-1B / JHW7-2D
JHW7-662	1 15/16	2 15/16	2 3/8	2 3/4	1 3/16	1 23/32	1 3/8	1 15/16	1 15/16	JHW7-3XS	JHW7-1B / JHW7-2D
JHW7-664	2	3 1/8	2 3/8	3	1 9/32	1 31/32	1 13/32	2 1/8	2 1/8	JHW7-3XS	JHW7-1B / JHW7-2D
JHW7-666	2 1/16	3 1/8	2 3/8	3	1 9/32	1 31/32	1 1/2	2 1/8	2 1/8	JHW7-3XS	JHW7-1B / JHW7-2D
JHW7-668	2 1/8	3 1/4	2 3/8	3 1/8	1 9/32	1 31/32	1 5/8	2 1/4	2 1/4	JHW7-3XS	JHW7-1B / JHW7-2D
JHW7-670	2 3/16	3 5/16	2 3/8	3 1/4	1 7/16	2 5/32	1 5/8	2 5/16	2 5/16	JHW7-3XS	JHW7-1B / JHW7-2D
JHW7-672	2 1/4	3 9/16	2 3/8	3 1/4	1 7/16	2 5/32	1 5/8	2 5/16	2 5/16	JHW7-3XS	JHW7-1B / JHW7-2D
JHW7-674	2 5/16	3 1/2	2 3/8	3 3/8	1 1/2	2 5/32	1 3/4	2 1/2	2 1/2	JHW7-3XS	JHW7-1B / JHW7-2D
JHW7-676	2 3/8	3 1/2	2 3/8	3 1/2	1 1/2	2 11/32	1 3/4	2 1/2	2 1/2	JHW7-3XS	JHW7-1B / JHW7-2D
JHW7-678	2 7/16	3 1/2	2 3/8	3 1/2	1 1/2	2 11/32	1 3/4	2 1/2	2 1/2	JHW7-3XS	JHW7-1B / JHW7-2D
JHW7-680	2 1/2	3 5/8	2 3/8	3 1/2	1 5/8	2 15/32	2 1/2	2 5/8	2 5/8	JHW7-3XS	JHW7-1B / JHW7-2D
JHW7-682	2 9/16	3 5/8	2 3/8	3 5/8	1 5/8	2 15/32	2 9/16	2 5/8	2 5/8	JHW7-3XS	JHW7-1B / JHW7-2D
JHW7-684	2 5/8	3 5/8	2 3/8	3 3/4	1 5/8	2 5/16	1 7/8	2 5/8	2 5/8	JHW7-3XS	JHW7-1B / JHW7-2D
JHW7-686	2 11/16	3 7/8	2 3/8	3 3/4	1 13/16	2 15/32	2	2 7/8	2 7/8	JHW7-3XS	JHW7-1B / JHW7-2D
JHW7-688	2 3/4	3 7/8	2 3/8	3 3/4	1 13/16	2 21/32	2 3/4	2 7/8	2 7/8	JHW7-3XS	JHW7-1B / JHW7-2D
JHW7-690	2 13/16	4	2 3/8	4	1 13/16	2 11/16	2	3	3	JHW7-3XS	JHW7-1B / JHW7-2D
JHW7-692	2 7/8	4	2 3/8	4	1 13/16	2 11/16	2	3	3	JHW7-3XS	JHW7-1B / JHW7-2D
JHW7-694	2 15/16	4 3/16	2 3/8	4 1/8	2 1/32	2 11/16	2 15/16	3 1/8	3 1/8	JHW7-3XS	JHW7-1B / JHW7-2D
JHW7-696	3	4 3/8	2 3/8	4 1/4	2 1/16	3 5/16	2 3/8	3 3/8	3 3/8	JHW7-3XS	JHW7-1B / JHW7-2D
JHW7-6100	3 1/8	4 3/8	2 3/8	4 1/4	2 1/16	3 5/16	2 3/8	3 3/8	3 3/8	JHW7-3XS	JHW7-1B / JHW7-2D
JHW7-6104	3 1/4	4 3/8	2 3/8	4 1/2	2 1/16	3 1/32	2 3/8	3 3/8	3 3/8	JHW7-3XS	JHW7-1B / JHW7-2D
JHW7-6108	3 3/8	4 23/32	2 3/8	4 5/8	2 1/4	3 5/16	2 1/2	2 39/64	2 39/64	JHW7-3XS	JHW7-1B / JHW7-2D
JHW7-6112	3 1/2	4 3/4	2 3/8	4 3/4	2 1/4	3 11/32	2 1/2	2 5/8	2 5/8	JHW7-3XS	JHW7-1B / JHW7-2D
JHW7-6116	3 5/8	4 3/4	2 3/8	5	2 5/16	3 11/32	2 5/8	2 19/32	2 19/32	JHW7-3XS	JHW7-1B / JHW7-2D
JHW7-6118	3 11/16	4 3/4	2 3/8	5 5/16	2 7/16	3 13/32	2 3/4	2 15/16	2 15/16	JHW7-3XS	JHW7-1B / JHW7-2D
JHW7-6120	3 3/4	5 1/16	2 3/8	5 1/8	2 3/8	3 21/64	2 5/8	3 5/32	3 5/32	JHW7-3XS	JHW7-1B / JHW7-2D
JHW7-6122	3 13/16	5 3/16	2 3/8	5 3/8	2 17/32	3 9/16	2 5/8	3 23/64	3 23/64	JHW7-3XS	JHW7-1B / JHW7-2D
JHW7-6124	3 7/8	5 1/4	2 3/8	5 1/4	2 9/16	3 25/32	2 3/4	3 1/8	3 1/8	JHW7-3XS	JHW7-1B / JHW7-2D
JHW7-6126	3 15/16	5 5/16	2 3/8	5 11/32	2 9/16	3 25/32	3	3 3/16	3 3/16	JHW7-3XS	JHW7-1B / JHW7-2D
JHW7-6128	4	5 3/8	2 3/8	5 1/2	2 9/16	3 25/32	2 7/8	3 15/64	3 15/64	JHW7-3XS	JHW7-1B / JHW7-2D
JHW7-6130	4 1/16	5 3/8	2 3/8	5 1/2	2 15/32	2 19/32	3	3 39/64	3 39/64	JHW7-3XS	JHW7-1B / JHW7-2D
JHW7-6132	4 1/8	5 3/8	2 3/8	5 9/16	2 9/16	3 25/32	2 7/8	3 7/32	3 7/32	JHW7-3XS	JHW7-1B / JHW7-2D
JHW7-6134	4 3/16	5 1/2	2 3/8	6	2 39/64	3 59/64	3	3 41/64	3 41/64	JHW7-3XS	JHW7-1B / JHW7-2D
JHW7-6136	4 1/4	5 1/2	2 3/8	5 3/4	2 5/8	3 25/32	3 1/8	3 5/16	3 5/16	JHW7-3XS	JHW7-1B / JHW7-2D
JHW7-6138	4 5/16	5 1/2	2 3/8	5 13/16	2 21/32	3 25/32	3 3/8	3 3/16	3 3/16	JHW7-3XS	JHW7-1B / JHW7-2D
JHW7-6140	4 3/8	5 5/8	2 3/8	5 27/32	2 5/8	3 25/32	3 1/8	3 39/64	3 39/64	JHW7-3XS	JHW7-1B / JHW7-2D
JHW7-6142	4 7/16	5 5/8	2 3/8	6	2 43/64	3 25/32	2 5/8	3 19/32	3 19/32	JHW7-3XS	JHW7-1B / JHW7-2D
JHW7-6144	4 1/2	5 5/8	2 3/8	6	2 5/8	3 25/32	3 1/8	3 13/32	3 13/32	JHW7-3XS	JHW7-1B / JHW7-2D
JHW7-6146	4 9/16	5 5/8	3 1/4	6 1/2	2 3/4	3 1/2	3 3/8	3 17/32	3 17/32	JHW8-1XS	JHW7-1C - JHW7-2F
JHW7-6148	4 5/8	5 3/4	3 1/4	6 13/32	3 1/4	3 25/32	3 1/8	3 25/32	3 25/32	JHW8-1XS	JHW7-1C - JHW7-2F
JHW7-6152	4 3/4	5 3/4	3 1/4	6 5/8	2 57/64	3 29/32	3 1/2	3 23/32	3 23/32	JHW8-1XS	JHW7-1C - JHW7-2F
JHW7-6156	4 7/8	6	3 1/4	7	3	3 29/32	3 1/2	3 31/32	3 31/32	JHW8-1XS	JHW7-1C - JHW7-2F
JHW7-6160	5	6 1/4	3 1/4	7	3	4 3/16	3 1/2	4 7/32	4 7/32	JHW8-1XS	JHW7-1C - JHW7-2F
JHW7-6172	5 3/8	6 1/2	3 1/4	7 1/2	3 9/16	4 5/16	4 43/64	4 1/4	4 1/4	JHW8-1XS	JHW7-1C - JHW7-2F
JHW7-6184	5 3/4	6 1/2	3 1/4	8 1/4	3 9/16	4 17/32	4	4 9/32	4 9/32	JHW8-1XS	JHW7-1C - JHW7-2F

Fed. Spec: ANSI B107.2





TOOLS @ HEIGHT
 DROP PREVENTION SYSTEM

Side hole in socket permits use with Snap-on Industrial Brands Tools@Height drive tools such as ratchets, extensions and u-joints

1" DRIVE SHALLOW IMPACT SOCKETS, 12 POINT, SAE

Black Industrial Finish

Product Code	Size (MM)	A		B		C		D		E		F		Use O-Ring / Pin
		OAL (Inches)	Drive End Diameter (Inches)	Working End Diameter (Inches)	Broach Depth (Inches)	Bolt Clearance Depth (Inches)	Bolt Clearance Diameter (Inches)	Nose Length (Inches)	Uses RET RING® Number					
JHW7-1224	3/4"	2	2 1/8	1 3/8	1/2	7/8	3/4	3/4	JHW7-2XS	JHW7-1B/JHW7-2D				
JHW7-1226	13/16"	2 1/4	2 1/8	1 3/8	5/8	1 1/8	3/4	1	JHW7-2XS	JHW7-1B/JHW7-2D				
JHW7-1228	7/8"	2 1/4	2 1/8	1 1/2	5/8	1 1/8	3/4	1	JHW7-2XS	JHW7-1B/JHW7-2D				
JHW7-1230	15/16"	2 1/4	2 1/8	1 5/8	7/8	1 1/8	1	1	JHW7-2XS	JHW7-1B/JHW7-2D				
JHW7-1232	1"	2 1/4	2 1/8	1 5/8	7/8	1 1/8	1	1	JHW7-2XS	JHW7-1B/JHW7-2D				
JHW7-1234	1 1/16"	2 1/2	2 1/8	1 3/4	3/4	1 1/8	1	1 1/4	JHW7-2XS	JHW7-1B/JHW7-2D				
JHW7-1236	1 1/8"	2 1/2	2 1/8	1 3/4	3/4	1 1/8	1	1 1/4	JHW7-2XS	JHW7-1B/JHW7-2D				
JHW7-1238	1 3/16"	2 1/2	2 1/8	1 7/8	3/4	1 1/8	1 1/4	1 1/4	JHW7-2XS	JHW7-1B/JHW7-2D				
JHW7-1240	1 1/4"	2 1/2	2 1/8	2	3/4	1 1/8	1 1/4	1 1/4	JHW7-2XS	JHW7-1B/JHW7-2D				
JHW7-1242	1 5/16"	2 3/4	2 1/8	2 1/8	7/8	1 5/8	1 1/4	-	JHW7-2XS	JHW7-1B/JHW7-2D				
JHW7-1244	1 3/8"	2 3/4	2 1/8	2 1/8	7/8	1 5/8	1 1/8	-	JHW7-2XS	JHW7-1B/JHW7-2D				
JHW7-1246	1 7/16"	2 3/4	2 1/8	2 1/8	1	1 5/8	1 7/16	-	JHW7-2XS	JHW7-1B/JHW7-2D				
JHW7-1248	1 1/2"	2 3/4	2 1/8	2 3/8	1	1 5/8	1 7/16	-	JHW7-2XS	JHW7-1B/JHW7-2D				
JHW7-1250	1 9/16"	2 3/4	2 1/8	2 3/8	1	1 5/8	1 7/16	-	JHW7-2XS	JHW7-1B/JHW7-2D				
JHW7-1252	1 5/8"	2 3/4	2 1/8	2 3/8	1 1/8	1 5/8	1 9/16	-	JHW7-2XS	JHW7-1B/JHW7-2D				
JHW7-1254	1 11/16"	2 3/4	2 1/8	2 5/8	1 1/8	1 5/8	1 7/16	-	JHW7-2XS	JHW7-1B/JHW7-2D				
JHW7-1256	1 3/4"	3	2 1/8	2 5/8	1 1/4	1 7/8	1 7/16	-	JHW7-2XS	JHW7-1B/JHW7-2D				
JHW7-1258	1 13/16"	3	2 1/8	2 5/8	1 1/8	1 7/8	1 7/16	-	JHW7-2XS	JHW7-1B/JHW7-2D				
JHW7-1260	1 7/8"	3	2 1/8	2 3/4	1 1/4	1 7/8	1 7/16	-	JHW7-2XS	JHW7-1B/JHW7-2D				
JHW7-1262	1 15/16"	3 1/4	2 1/8	2 7/8	1	2	1 7/8	-	JHW7-2XS	JHW7-1B/JHW7-2D				
JHW7-1264	2"	3 1/4	2 1/8	2 7/8	1 1/8	2	2	-	JHW7-2XS	JHW7-1B/JHW7-2D				
JHW7-1266	2 1/16"	3 1/2	2 1/8	3	1 1/8	2 1/8	2	-	JHW7-2XS	JHW7-1B/JHW7-2D				
JHW7-1268	2 1/8"	3 1/2	2 1/8	3	1 1/8	2 1/8	2	-	JHW7-2XS	JHW7-1B/JHW7-2D				
JHW7-1270	2 3/16"	3 1/2	2 3/8	3 1/8	1 1/2	2 1/8	2 1/8	-	JHW7-3XS	JHW7-1B/JHW7-2D				
JHW7-1272	2 1/4"	3 1/2	2 3/8	3 1/4	1 1/2	2 1/8	2 1/4	-	JHW7-3XS	JHW7-1B/JHW7-2D				
JHW7-1274	2 5/16"	3 3/4	2 3/8	3 1/4	1 1/2	2 3/8	2 1/4	-	JHW7-3XS	JHW7-1B/JHW7-2D				
JHW7-1276	2 3/8"	3 3/4	2 3/8	3 3/8	1 1/2	2 3/8	2 1/8	-	JHW7-3XS	JHW7-1B/JHW7-2D				
JHW7-1278	2 7/16"	3 3/4	2 3/8	3 1/2	1 1/2	2 1/4	2 1/2	-	JHW7-3XS	JHW7-1B/JHW7-2D				
JHW7-1280	2 1/2"	3 3/4	2 3/8	3 1/2	1 1/2	2 1/4	2 1/2	-	JHW7-3XS	JHW7-1B/JHW7-2D				
JHW7-1282	2 9/16"	4	2 3/8	3 5/8	1 1/2	2 1/2	2 1/2	-	JHW7-3XS	JHW7-1B/JHW7-2D				
JHW7-1284	2 5/8"	4	2 3/8	3 5/8	1 1/2	2 1/2	2 1/2	-	JHW7-3XS	JHW7-1B/JHW7-2D				
JHW7-1286	2 11/16"	4	2 3/8	3 3/4	1 3/4	2 1/2	2 3/8	-	JHW7-3XS	JHW7-1B/JHW7-2D				
JHW7-1288	2 3/4"	4 1/4	2 3/8	3 7/8	1 3/4	2 3/4	2 3/4	-	JHW7-3XS	JHW7-1B/JHW7-2D				
JHW7-1290	2 13/16"	4 1/4	2 3/8	3 7/8	1 3/4	2 11/16	2 3/4	-	JHW7-3XS	JHW7-1B/JHW7-2D				
JHW7-1292	2 7/8"	4 1/4	2 3/8	4	1 3/4	2 11/16	2 3/4	-	JHW7-3XS	JHW7-1B/JHW7-2D				
JHW7-1294	2 15/16"	4 1/4	2 3/8	4 1/8	1 3/4	2 5/8	3	-	JHW7-3XS	JHW7-1B/JHW7-2D				
JHW7-1296	3"	4 1/4	2 3/8	4 1/8	1 3/4	2 5/8	3	-	JHW7-3XS	JHW7-1B/JHW7-2D				
JHW7-1298	3 1/16"	4 1/2	2 3/8	4 1/4	2	2 7/8	3	-	JHW7-3XS	JHW7-1B/JHW7-2D				
JHW7-12100	3 1/8"	4 1/2	2 3/8	4 1/4	2	2 7/8	3	-	JHW7-3XS	JHW7-1B/JHW7-2D				
JHW7-12104	3 1/4"	4 1/2	2 3/8	4 1/2	2	2 13/16	3 1/4	-	JHW7-3XS	JHW7-1B/JHW7-2D				
JHW7-12108	3 3/8"	5	2 3/8	4 5/8	2 1/4	3 1/4	3 1/4	-	JHW7-3XS	JHW7-1B/JHW7-2D				
JHW7-12112	3 1/2"	5	2 3/8	5	2 1/4	3 1/4	3 1/2	-	JHW7-3XS	JHW7-1B/JHW7-2D				
JHW7-12116	3 5/8"	5	2 3/8	4 7/8	2 1/4	3 3/16	3 5/8	-	JHW7-3XS	JHW7-1B/JHW7-2D				
JHW7-12120	3 3/4"	5	2 3/8	5 1/8	2 1/4	3 3/16	3 3/4	-	JHW7-3XS	JHW7-1B/JHW7-2D				
JHW7-12124	3 7/8"	5 1/2	2 3/8	5 1/4	2 1/2	3 5/8	3 7/8	-	JHW7-3XS	JHW7-1B/JHW7-2D				
JHW7-12128	4"	5 1/2	2 3/8	5 3/8	2 1/2	3 5/8	4	-	JHW7-3XS	JHW7-1B/JHW7-2D				
JHW7-12132	4 1/8"	5 1/2	2 3/8	5 1/2	2 1/2	3 1/2	4	-	JHW7-3XS	JHW7-1B/JHW7-2D				
JHW7-12136	4 1/4"	5 1/2	2 3/8	5 3/4	2 1/2	3 1/2	4 1/4	-	JHW7-3XS	JHW7-1B/JHW7-2D				
JHW7-12144	4 1/2"	5 3/4	2 3/8	6	2 1/2	3 2/3	4 1/2	-	JHW7-3XS	JHW7-1B/JHW7-2D				



JHW7-1296

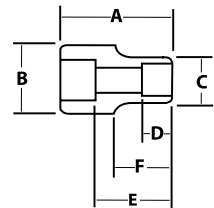

1" DRIVE

SOCKETS AND DRIVE TOOLS

Features

- SUPERTORQUE™ lobular openings for greater turning power without deforming the fastener
- Designed for maximum engagement on 6 and 12 point fasteners
- Suitable for use with pneumatic and electric impact wrenches
- Specially heat treated for impact use to provide long life, safety, and durability



TOOLS @ HEIGHT
 DROP PREVENTION SYSTEM

Side hole in socket permits use with Snap-on Industrial Brands Tools@Height drive tools such as ratchets, extensions and u-joints



JHW17-660

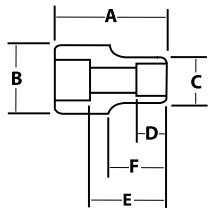

1" DRIVE DEEP IMPACT SOCKETS, 6 POINT, SAE

Black Industrial Finish

Product Code	A		B		C		D		E		F		RET RING® Number	Use O-Ring / Pin
	Size (Inches)	OAL (Inches)	Drive End Diameter (Inches)	Working End Diameter (Inches)	Broach Depth (Inches)	Bolt Clearance Depth (Inches)	Bolt Clearance Diameter (Inches)	Nose Length (Inches)						
JHW17-632	1	3	2 1/8	1 19/32	3/4	1 13/16	1 1/16	7/8	JHW7-2XS	JHW7-1B / JHW7-2D				
JHW17-634	1 1/16	3 3/4	2 1/8	1 3/4	1 23/32	2 19/32	3/4	7/8	JHW7-2XS	JHW7-1B / JHW7-2D				
JHW17-636	1 1/8	3 3/4	2 1/8	1 13/16	1 25/32	2 19/32	7/8	7/8	JHW7-2XS	JHW7-1B / JHW7-2D				
JHW17-638	1 3/16	3	2 1/8	1 19/16	3/4	1 13/16	1 13/16	7/8	JHW7-2XS	JHW7-1B / JHW7-2D				
JHW17-640	1 1/4	3 3/4	2 1/8	1 31/32	1 15/16	2 19/32	7/8	1	JHW7-2XS	JHW7-1B / JHW7-2D				
JHW17-642	1 5/16	3 3/4	2 1/8	2 1/16	2 1/32	2 27/32	1	1	JHW7-2XS	JHW7-1B / JHW7-2D				
JHW17-644	1 3/8	4	2 1/8	2 1/16	2 1/8	2 27/32	1	1	JHW7-2XS	JHW7-1B / JHW7-2D				
JHW17-646	1 7/16	4	2 1/8	2 1/4	2 3/16	2 27/32	1	2 1/4	JHW7-2XS	JHW7-1B / JHW7-2D				
JHW17-648	1 1/2	4	2 1/4	2 3/8	2 1/4	2 27/32	1 1/8	2 1/2	JHW7-2XS	JHW7-1B / JHW7-2D				
JHW17-650	1 5/8	3 1/2	2 1/4	2 3/8	1	2 11/32	1 17/32	2 1/2	JHW7-2XS	JHW7-1B / JHW7-2D				
JHW17-652	1 9/16	3 5/8	2 1/4	2 7/16	2 13/32	3 3/32	1 1/8	2 5/8	JHW7-2XS	JHW7-1B / JHW7-2D				
JHW17-654	1 11/16	4 1/4	2 1/4	2 17/32	2 1/2	3 3/32	1 1/4	2 5/8	JHW7-3XS	JHW7-1B / JHW7-2D				
JHW17-656	1 3/4	4 1/4	2 1/4	2 19/32	2 9/16	3 1/32	1 1/4	2 7/8	JHW7-3XS	JHW7-1B / JHW7-2D				
JHW17-658	1 13/16	4 1/2	2 1/4	2 11/16	2 21/32	3 3/32	1 1/4	2 7/8	JHW7-3XS	JHW7-1B / JHW7-2D				
JHW17-660	1 7/8	4 1/2	2 1/4	2 3/4	2 3/4	3 1/4	1 3/8	2 7/8	JHW7-3XS	JHW7-1B / JHW7-2D				
JHW17-662	1 15/16	4 1/2	2 1/4	2 27/32	2 13/16	3 1/4	1 3/8	3 1/8	JHW7-3XS	JHW7-1B / JHW7-2D				
JHW17-664	2	4 1/2	2 1/4	2 29/32	2 7/8	3 3/32	1 3/8	3 1/8	JHW7-3XS	JHW7-1B / JHW7-2D				
JHW17-666	2 1/16	4 3/4	2 1/4	3	2 31/32	3 15/32	1 1/2	3 1/8	JHW7-3XS	JHW7-1B / JHW7-2D				
JHW17-668	2 1/8	4 3/8	2 3/8	3 1/4	1 5/16	3 1/16	1 3/8	3 3/8	JHW7-3XS	JHW7-1B / JHW7-2D				
JHW17-670	2 3/16	4 3/4	2 13/32	3 3/32	3 1/8	3 7/16	1 1/2	3 3/8	JHW7-3XS	JHW7-1B / JHW7-2D				
JHW17-672	2 1/4	4 3/4	2 13/32	3 7/32	3 3/16	3 13/32	1 5/8	3 3/8	JHW7-3XS	JHW7-1B / JHW7-2D				
JHW17-674	2 5/16	5	2 13/32	3 5/16	3 3/8	3 21/32	1 5/8	3 1/2	JHW7-3XS	JHW7-1B / JHW7-2D				
JHW17-676	2 3/8	5	2 13/32	3 3/8	3 3/8	3 5/8	1 3/4	3 1/2	JHW7-3XS	JHW7-1B / JHW7-2D				
JHW17-678	2 7/16	4 1/2	2 3/8	3 1/2	1 1/2	3 3/32	1 3/4	3 1/2	JHW7-3XS	JHW7-1B / JHW7-2D				
JHW17-680	2 1/2	4 1/2	2 3/8	3 1/2	1 5/8	3	2 1/2	3 1/2	JHW7-3XS	JHW7-1B / JHW7-2D				
JHW17-682	2 9/16	4 7/8	2 3/8	3 5/8	1 5/8	3 1/2	2	3 7/8	JHW7-3XS	JHW7-1B / JHW7-2D				
JHW17-684	2 5/8	4 11/16	2 3/8	3 3/4	1 5/8	3 11/32	2	3 11/16	JHW7-3XS	JHW7-1B / JHW7-2D				
JHW17-686	2 11/16	4 11/16	2 3/8	3 3/4	1 13/16	2 1/2	2	3 11/16	JHW7-3XS	JHW7-1B / JHW7-2D				
JHW17-688	2 3/4	5 1/8	2 3/8	3 3/4	1 3/4	3 5/8	2	4 1/8	JHW7-3XS	JHW7-1B / JHW7-2D				
JHW17-690	2 13/16	5 1/8	2 3/8	4	1 13/16	2 7/32	2	4 1/8	JHW7-3XS	JHW7-1B / JHW7-2D				
JHW17-692	2 7/8	4 7/8	2 3/8	4	1 13/16	3 9/16	2	3 7/8	JHW7-3XS	JHW7-1B / JHW7-2D				
JHW17-694	2 15/16	4 7/8	2 3/8	4 1/8	2 1/32	2 11/16	2	3 7/8	JHW7-3XS	JHW7-1B / JHW7-2D				
JHW17-696	3	5 1/8	2 3/8	4 1/4	2 1/32	3 7/8	2 3/8	4 1/8	JHW7-3XS	JHW7-1B / JHW7-2D				
JHW17-6100	3 1/8	5 1/8	2 3/8	4 3/8	2 1/32	3 1/32	2 3/8	4 1/8	JHW7-3XS	JHW7-1B / JHW7-2D				
JHW17-6104	3 1/4	5 3/8	2 3/8	4 1/2	2 1/32	3 1/32	2 3/8	4 3/8	JHW7-3XS	JHW7-1B / JHW7-2D				
JHW17-6108	3 3/8	5 1/2	2 3/8	4 5/8	2 1/4	3 5/16	2 1/2	4 1/2	JHW7-3XS	JHW7-1B / JHW7-2D				
JHW17-6112	3 1/2	5 1/2	2 3/8	4 3/4	2 1/4	4 3/32	2 1/2	4 1/2	JHW7-3XS	JHW7-1B / JHW7-2D				
JHW17-6116	3 5/8	5 1/2	2 3/8	5	2 5/16	4 3/32	2 5/8	4 1/2	JHW7-3XS	JHW7-1B / JHW7-2D				
JHW17-6118	3 11/16	5 17/32	2 3/8	5 9/16	2 7/16	3 7/8	2 3/4	4 17/32	JHW7-3XS	JHW7-1B / JHW7-2D				
JHW17-6120	3 3/4	5 9/16	2 3/8	5 1/4	2 1/4	3 19/32	2 13/16	4 9/16	JHW7-3XS	JHW7-1B / JHW7-2D				
JHW17-6122	3 13/16	5 31/32	2 3/8	5 5/8	2 17/32	4 11/32	2 5/8	4 31/32	JHW7-3XS	JHW7-1B / JHW7-2D				
JHW17-6124	3 7/8	5 9/16	2 3/8	5 1/4	2 9/16	3 5/8	3	4 9/16	JHW7-3XS	JHW7-1B / JHW7-2D				
JHW17-6126	3 15/16	6 1/16	2 3/8	5 1/2	2 13/32	4 19/32	3	5 1/16	JHW7-3XS	JHW7-1B / JHW7-2D				
JHW17-6128	4	6 1/8	2 3/8	5 1/2	2 17/32	4 3/32	2 7/8	5 1/8	JHW7-3XS	JHW7-1B / JHW7-2D				
JHW17-6130	4 1/16	6 1/8	2 3/8	5 1/2	2 17/32	4 1/2	3	5 5/32	JHW7-3XS	JHW7-1B / JHW7-2D				
JHW17-6132	4 1/8	6 1/8	2 3/8	5 17/32	2 17/32	4 3/32	2 7/8	5 1/8	JHW7-3XS	JHW7-1B / JHW7-2D				
JHW17-6134	4 3/16	6 7/32	2 3/8	6	2 1/2	4 9/16	3	5 7/32	JHW7-3XS	JHW7-1B / JHW7-2D				
JHW17-6136	4 1/4	6 9/32	2 3/8	5 3/4	2 3/8	4 9/16	3 1/8	5 9/32	JHW7-3XS	JHW7-1B / JHW7-2D				
JHW17-6138	4 5/16	6 11/32	2 3/8	5 13/16	2 21/32	4 5/8	3 3/8	5 11/32	JHW7-3XS	JHW7-1B / JHW7-2D				
JHW17-6140	4 3/8	6 13/32	2 3/8	5 27/32	2 3/8	4 9/16	3 1/8	5 13/32	JHW7-3XS	JHW7-1B / JHW7-2D				
JHW17-6142	4 7/16	6 13/32	2 3/8	6	2 21/32	4 9/16	2 5/8	5 13/32	JHW7-3XS	JHW7-1B / JHW7-2D				
JHW17-6144	4 1/2	7	2 3/8	6	2 3/4	5	3 1/8	6	JHW7-3XS	JHW7-1B / JHW7-2D				
JHW17-6146	4 9/16	7 1/8	3 1/4	6 1/2	2 3/4	4 19/32	3 3/8	6 1/8	JHW8-1XS	JHW7-1C - JHW7-2F				
JHW17-6148	4 5/8	7 1/8	3 1/4	6 13/16	2 19/16	4 3/32	3 1/2	6 1/8	JHW8-1XS	JHW7-1C - JHW7-2F				
JHW17-6152	4 3/4	6 3/4	3 1/4	6 5/8	2 29/32	4 29/32	3 1/2	5 3/4	JHW8-1XS	JHW7-1C - JHW7-2F				
JHW17-6156	4 7/8	7 1/4	3 1/4	7	3	5 5/32	3 1/2	6 1/4	JHW8-1XS	JHW7-1C - JHW7-2F				
JHW17-6160	5	7 3/4	3 1/4	7	3	5 21/32	3 1/2	6 3/4	JHW8-1XS	JHW7-1C - JHW7-2F				
JHW17-6172	5 5/8	8	3 1/4	7 1/2	3 9/16	5 29/32	3 21/32	7	JHW8-1XS	JHW7-1C - JHW7-2F				
JHW17-6184	5 3/4	8	3 1/4	8 1/4	3 9/16	6 1/32	4	7	JHW8-1XS	JHW7-1C - JHW7-2F				

Fed. Spec: ANSI B107.2



Features

- SUPERTORQUE™ lobular openings for greater turning power without deforming the fastener
- Designed for maximum engagement on 6 point fasteners
- Suitable for use with pneumatic and electric impact wrenches
- Specially heat treated for impact use to provide long life, safety, and durability

1" DRIVE SOCKETS AND DRIVE TOOLS



1" DRIVE SHALLOW IMPACT SOCKETS, 6 POINT, METRIC

Black Industrial Finish

Product Code	Size (MM)	A		B		C		D		E		F		Uses RET RING® Number	Use O-Ring / Pin
		OAL (Inches)	Drive End Diameter (Inches)	Working End Diameter (Inches)	Broach Depth (Inches)	Bolt Clearance Depth (Inches)	Bolt Clearance Diameter (Inches)	Nose Length (Inches)							
JHW7M-627	27	2 1/4	2 1/8	1 3/4	1 1/16	1 1/16	3/4	7/8	JHW7-2XS	JHW7-1B / JHW 7-2D					
JHW7M-630	30	2 1/4	2 1/8	1 7/8	1 1/16	1 1/16	13/16	7/8	JHW7-2XS	JHW7-1B / JHW7-2D					
JHW7M-632	32	2 3/8	2 1/8	2	3/4	1 3/16	15/16	7/8	JHW7-2XS	JHW7-1B / JHW7-2D					
JHW7M-635	35	2 1/2	2 1/8	2 1/8	7/8	1 3/16	1 3/16	-	JHW7-2XS	JHW7-1B / JHW7-2D					
JHW7M-638	38	2 5/8	2 1/4	2 11/32	15/16	1 15/32	1 1/2	1 5/8	JHW7-2XS	JHW7-1B / JHW7-2D					
JHW7M-641	41	2 3/4	2 1/4	2 3/8	1 1/16	1 3/8	1 19/32	1 3/4	JHW7-2XS	JHW7-1B / JHW7-2D					
JHW7M-646	46	2 15/16	2 3/8	2 3/4	1 3/16	1 23/32	1 19/16	1 15/16	JHW7-3XS	JHW7-1B / JHW7-2D					
JHW7M-650	50	3	2 3/8	2 3/4	1 1/4	1 27/32	1 61/64	2	JHW7-3XS	JHW7-1B / JHW7-2D					
JHW7M-660	60	3 1/2	2 3/8	3 1/2	1 1/2	2 11/32	1 3/4	2 1/2	JHW7-3XS	JHW7-1B / JHW7-2D					
JHW7M-665	65	3 3/8	2 3/8	3 5/8	1 5/8	2 1/8	2 1/4	2 3/8	JHW7-3XS	JHW7-1B / JHW7-2D					
JHW7M-670	70	3 7/8	2 3/8	3 3/4	1 13/16	2 21/32	2 3/4	2 7/8	JHW7-3XS	JHW7-1B / JHW7-2D					
JHW7M-675	75	4 3/16	2 3/8	4 1/8	2 1/32	2 11/16	2 15/16	3 1/8	JHW7-3XS	JHW7-1B / JHW7-2D					

Features

- SUPERTORQUE™ lobular openings for greater turning power without deforming the fastener
- Designed for maximum engagement on 6 point fasteners
- Suitable for use with pneumatic and electric impact wrenches
- Specially heat treated for impact use to provide long life, safety, and durability
- Drive end features pin retention hole and groove
- Dual marked with corresponding SAE size



Side hole in socket permits use with Snap-on Industrial Brands Tools@Height drive tools such as ratchets, extensions and u-joints



JHW7M-650

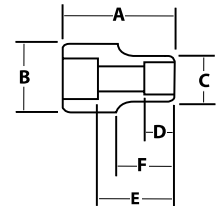

1-1/2" DRIVE IMPACT EXTENSIONS AND ACCESSORIES

Black Industrial Finish

Product Code	Description	Length (Inches)	Use RET RING®	Use O-Ring / Pin	Socket Retention
JHW8-108	Impact Extension	8	JHW8-1XS	JHW7-1C / JHW8-2E	Through Hole and Pin
JHW8-115	Impact Extension	15	JHW8-1XS	JHW7-1C / JHW8-2E	Through Hole and Pin
JHW8-140B	Impact Universal Joint	6 1/16	JHW8-1XS	JHW7-1C / JHW8-2E	Through Hole and Pin
JHW8-7	1" M x 1 1/2" F Adapter	4 1/4	JHW8-1XS	JHW7-1C / JHW8-2E	Through Hole and Pin
JHW8-8	1 1/2" M x 2 1/2" F Adapter	6 3/8	JHW8-4XS	JHW9-1D / JHW9-2G	Through Hole and Pin

Fed. Spec: ANSI B107.2

Features

- Specially heat treated for impact use to provide long life, safety, and durability.
- Pin and o-ring or RET RING® (sold separately) secure tools onto impact wrench for safety and convenience.
- Universal joint provides 55° range of motion.
- Suitable for use with pneumatic and electric impact wrenches.
- Drive end features pin retention hole and groove.



JHW8-108



JHW8-140B



JHW8-7



JHW8-8

1-1/2" SLIDING T-HANDLE

Black Industrial Finish

Product Code	Length (Inches)	Shaft Diameter (Inches)	Socket Retention
JHW8-20	36	2 1/2	Plunger and Spring

Features

- Drive end slides on bar for additional flexibility.
- Ideal for turning 1-1/2" drive sockets when impact wrench is not available.



JHW8-20

1" AND 1-1/2" DRIVE

SOCKETS AND DRIVE TOOLS



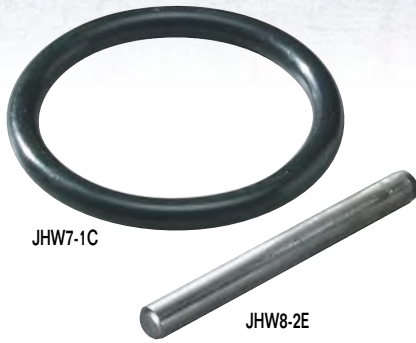

JHW7-1C

JHW8-2E

1-1/2" DRIVE IMPACT RETAINING PINS AND RINGS

Product Code	Description	Dia. (Inches)	Length (Inches)	Application
JHW7-1C	Impact Retaining O-Ring	3 1/4	NA	Fits All Williams 1 1/2" Drive Sockets & Accessories
JHW8-2E	Impact Retaining Pin	1/4	2 7/8	Fits All Williams 1 1/2" Drive Sockets & Accessories
JHW9-1D	Impact Retaining O-Ring	4 1/8	NA	
JHW9-2G	Impact Retaining Pin	5/16	2 7/8	

Features

- Specially heat treated for impact use to provide long life, safety, and durability
- Suitable for use with pneumatic and electric impact wrenches
- For 1-1/2" Drive impact tools with pin retention hole and groove



JHW8-1XS

1-1/2" DRIVE RET RING® ONE-PIECE IMPACT RETAINING RINGS WITH CRUSH GAUGE

Product Code	Diameter (Inches)	Application
JHW8-1XS	2 7/8	Fits Williams 1 1/2" Drive Tools with "B" Dimension of 3 1/4"
JHW8-2XS	3 3/8	Fits Competitive Impact Sockets
JHW8-3XS	3 7/8	Fits Competitive Impact Sockets
JHW8-4XS	4 3/8	Fits Competitive Impact Sockets

Features

- Fits all Williams 1-1/2" Drive Sockets and Accessories
- Crush Gauge on the resin pin indicates when a socket is excessively worn and should be replaced
- Securely retains sockets and accessories to square drive of impact wrench
- For 1-1/2" drive impact tools with pin retention hole and groove
- Made of oil resistant material
- RET RING® is a trademark of FTL Enterprises, Inc.



JHW41144

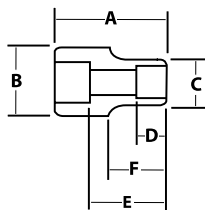

1-1/2" DRIVE SHALLOW IMPACT SOCKETS, 12 POINT, SAE



Black Industrial Finish

Product Code	Size (Inches)	Dimensions						
		A Overall Length (Inches)	B Drive End Diameter (Inches)	C Working End Diameter (Inches)	D Broach Depth (Inches)	E Bolt Clearance Depth (Inches)	F Bolt Clearance Diameter (Inches)	Nose Length (Inches)
JHW41144	1 3/8	3 1/8	3 3/8	2 1/2	1	/	1 3/16	1 3/8
JHW41146	1 7/16	3 1/8	3 3/8	2 1/2	1	/	1 1/4	1 3/8
JHW41148	1 1/2	3 3/8	3 3/8	2 5/8	1	/	1 1/4	1 3/8
JHW41150	1 9/16	3 1/8	3 3/8	2 5/8	1	/	1 3/8	1 3/8
JHW41152	1 5/8	3 1/8	3 3/8	2 3/4	1	/	1 3/8	1 3/8
JHW41154	1 11/16	3 1/4	3 3/8	2 3/4	1 1/16	/	1 1/2	1 1/2
JHW41156	1 3/4	3 1/4	3 3/8	2 15/16	1 1/16	/	1 1/2	1 1/2
JHW41158	1 13/16	3 1/4	3 3/8	2 15/16	1 1/16	/	1 5/8	1 1/2
JHW41160	1 7/8	3 7/16	3 3/8	3 1/8	1 3/16	/	1 5/8	1 5/8
JHW41162	1 15/16	3 7/16	3 3/8	3 1/8	1 3/16	/	1 3/4	1 5/8
JHW41164	2	3 7/16	3 3/8	3 1/4	1 3/16	/	1 3/4	1 5/8
JHW41166	2 1/16	3 7/16	3 3/8	3 1/4	1 3/16	/	1 7/8	1 5/8
JHW41168	2 1/8	3 1/2	3 3/8	3 3/8	1 1/2	/	1 7/8	/
JHW41170	2 3/16	3 1/2	3 3/8	3 3/8	1 1/2	/	1 7/8	/
JHW41172	2 1/4	3 1/2	3 3/8	3 5/8	1 1/2	/	2 1/16	1 3/4
JHW41174	2 5/16	3 1/2	3 3/8	3 5/8	1 1/2	/	2 1/16	1 3/4
JHW41176	2 3/8	3 1/2	3 3/8	3 5/8	1 1/2	/	2 1/16	1 3/4
JHW41178	2 7/16	3 3/4	3 3/8	3 7/8	1 5/8	/	3/4	1 3/4
JHW41180	2 1/2	3 3/4	3 3/8	3 7/8	1 5/8	/	3/4	1 3/4
JHW41182	2 9/16	3 3/4	3 3/8	3 7/8	1 5/8	/	3/4	1 3/4
JHW41184	2 5/8	3 3/4	3 3/8	4 3/16	1 5/8	/	2 7/16	1 3/4
JHW41186	2 11/16	3 3/4	3 3/8	4 3/16	1 5/8	/	2 7/16	1 3/4
JHW41188	2 3/4	3 3/4	3 3/8	4 3/16	1 5/8	/	2 1/2	1 3/4
JHW41190	2 13/16	4 1/16	3 3/8	4 1/4	1 3/4	/	2 1/2	1 3/4
JHW41192	2 7/8	4 1/16	3 3/8	4 1/4	1 3/4	/	2 5/8	1 3/4
JHW41194	2 15/16	4 1/16	3 3/8	4 1/4	1 3/4	/	2 5/8	1 3/4
JHW41196	3	4 1/4	3 3/8	4 5/8	2	/	2 3/4	1 3/4
JHW41200	3 1/8	4 1/4	3 3/8	4 5/8	2	/	2 3/4	1 3/4
JHW41204	3 1/4	4 1/4	3 3/8	4 15/16	2	/	3	1 3/4
JHW41208	3 3/8	4 1/4	3 3/8	4 15/16	2	/	3	1 3/4
JHW41212	3 1/2	4 5/8	3 3/8	5	2 3/16	/	3 1/4	1 3/4
JHW41220	3 3/4	4 5/8	3 3/4	5 1/4	2 3/16	/	3 1/2	2
JHW41224	3 7/8	4 15/16	3 3/4	5 7/8	2 1/4	/	3 5/8	2
JHW41226	3 15/16	4 15/16	3 3/4	5 7/8	2 1/4	/	3 5/8	2
JHW41228	4	4 15/16	3 3/4	5 7/8	2 1/4	/	3 3/4	2

Features

- SUPERTORQUE™ lobular openings for greater turning power without deforming the fastener
- Designed for maximum engagement on 6 and 12 point fasteners
- Suitable for use with pneumatic and electric impact wrenches
- Specially heat treated for impact use to provide long life, safety, and durability



1-1/2" DRIVE SOCKETS AND DRIVE TOOLS



1-1/2" DRIVE SHALLOW IMPACT SOCKETS, 6 POINT, SAE

Black Industrial Finish

Product Code	Size (Inches)	A OAL (Inches)	B Drive End Diameter (Inches)	C Working End Diameter (Inches)	D Broach Depth (Inches)	E Bolt Clearance Depth (Inches)	F Bolt Clearance Diameter (Inches)	Nose Length (Inches)	Uses RET RING® Number	Use O-Ring / Pin
JHW8-646	1 7/16	3 1/2	3 1/4	2 7/8	57/64	1 25/64	1 7/16	1 7/32	JHW8-1XS	JHW7-1C / JHW8-2E
JHW8-648	1 1/2	3 3/32	3 1/4	2 7/8	29/32	1 7/16	1 31/64	1 17/64	JHW8-1XS	JHW7-1C / JHW8-2E
JHW8-652	1 5/8	3 3/16	3 1/4	2 29/32	1 1/32	1 9/16	1 5/8	1 21/64	JHW8-1XS	JHW7-1C / JHW8-2E
JHW8-654	1 11/16	3 1/4	3 1/4	2 31/32	1 1/16	1 9/16	1 11/16	1 39/64	JHW8-1XS	JHW7-1C / JHW8-2E
JHW8-656	1 3/4	3 9/32	3 1/4	3 1/32	1 1/32	1 21/32	1 21/32	1 9/16	JHW8-1XS	JHW7-1C / JHW8-2E
JHW8-658	1 13/16	3 21/64	3 1/4	3 3/32	1 5/32	1 11/64	1 13/16	1 5/8	JHW8-1XS	JHW7-1C / JHW8-2E
JHW8-660	1 7/8	3 3/8	3 1/4	3 5/32	1 7/32	1 3/4	1 7/8	1 23/32	JHW8-1XS	JHW7-1C / JHW8-2E
JHW8-664	2	3 7/16	3 1/4	3 1/2	1 9/32	1 13/16	2	1 51/64	JHW8-1XS	JHW7-1C / JHW8-2E
JHW8-666	2 1/16	3 1/2	3 1/4	3 1/2	1 13/32	1 59/64	2 1/16	1 59/64	JHW8-1XS	JHW7-1C / JHW8-2E
JHW8-668	2 1/8	3 9/16	3 1/4	3 1/2	1 27/64	1 59/64	2 1/8	1 59/64	JHW8-1XS	JHW7-1C / JHW8-2E
JHW8-670	2 3/8	3 21/32	3 1/4	3 1/2	1 7/16	2	2 3/16	2 1/64	JHW8-1XS	JHW7-1C / JHW8-2E
JHW8-672	2 1/4	3 3/4	3 1/4	3 9/16	1 17/32	2 1/8	2 1/4	2 1/8	JHW8-1XS	JHW7-1C / JHW8-2E
JHW8-676	2 3/8	3 7/8	3 1/4	3 25/32	1 9/16	2 1/4	2 3/8	2 17/64	JHW8-1XS	JHW7-1C / JHW8-2E
JHW8-678	2 7/8	3 15/16	3 1/4	3 25/32	1 9/16	2 19/64	2 7/8	2 5/16	JHW8-1XS	JHW7-1C / JHW8-2E
JHW8-680	2 1/2	4	3 1/4	3 7/8	1 19/32	2 3/8	2 31/64	2 1/64	JHW8-1XS	JHW7-1C / JHW8-2E
JHW8-682	2 9/16	4 1/32	3 1/4	3 29/32	1 5/8	2 19/32	2 9/16	2 3/64	JHW8-1XS	JHW7-1C / JHW8-2E
JHW8-684	2 5/8	4 3/32	3 1/4	4	1 11/16	2 5/8	2 5/8	2 7/64	JHW8-1XS	JHW7-1C / JHW8-2E
JHW8-688	2 3/4	4 7/32	3 1/4	4 5/32	1 13/16	2 7/16	2 3/4	2 15/64	JHW8-1XS	JHW7-1C / JHW8-2E
JHW8-692	2 7/8	4 5/16	3 1/4	4 5/16	1 7/8	2 11/16	2 5/8	2 9/32	JHW8-1XS	JHW7-1C / JHW8-2E
JHW8-694	2 15/16	4 3/8	3 1/4	4 3/8	1 29/32	2 3/4	2 5/8	2 23/64	JHW8-1XS	JHW7-1C / JHW8-2E
JHW8-696	3	4 7/16	3 1/4	4 7/16	1 5/16	2 27/32	2 5/8	2 13/32	JHW8-1XS	JHW7-1C / JHW8-2E
JHW8-698	3 1/16	4 1/2	3 1/4	4 9/16	1 31/32	2 7/8	2 5/8	2 15/32	JHW8-1XS	JHW7-1C / JHW8-2E
JHW8-6100	3 1/8	4 9/16	3 1/4	4 5/8	2	3	2 5/8	2 1/2	JHW8-1XS	JHW7-1C / JHW8-2E
JHW8-6104	3 1/4	4 21/32	3 1/4	4 25/32	2 1/8	3	2 5/8	2 19/32	JHW8-1XS	JHW7-1C / JHW8-2E
JHW8-6108	3 3/8	4 3/4	3 1/4	4 15/16	2 7/32	3 1/8	2 5/8	2 43/64	JHW8-1XS	JHW7-1C / JHW8-2E
JHW8-6110	3 7/16	4 27/32	3 1/4	5	2 9/32	3 3/32	2 5/8	2 3/4	JHW8-1XS	JHW7-1C / JHW8-2E
JHW8-6112	3 1/2	4 29/32	3 1/4	5 1/16	2 5/16	3 1/4	2 5/8	2 13/16	JHW8-1XS	JHW7-1C / JHW8-2E
JHW8-6116	3 5/8	5 1/8	3 1/4	5 1/4	2 13/32	3 7/16	2 5/8	3	JHW8-1XS	JHW7-1C / JHW8-2E
JHW8-6120	3 3/4	5 1/8	3 1/4	5 3/8	2 15/32	3 1/2	2 5/8	3 1/32	JHW8-1XS	JHW7-1C / JHW8-2E
JHW8-6122	3 13/16	5 3/16	3 1/4	5 3/8	2 17/32	3 7/8	2 5/8	3 3/32	JHW8-1XS	JHW7-1C / JHW8-2E
JHW8-6124	3 7/8	5 1/4	3 1/4	5 17/32	2 9/16	3 5/8	2 5/8	3 5/32	JHW8-1XS	JHW7-1C / JHW8-2E
JHW8-6128	4	5 13/32	3 1/4	5 21/32	2 3/4	3 25/32	2 5/8	3 9/32	JHW8-1XS	JHW7-1C / JHW8-2E
JHW8-6132	4 1/8	5 9/16	3 1/4	5 13/16	2 3/4	3 59/64	2 5/8	3 7/16	JHW8-1XS	JHW7-1C / JHW8-2E
JHW8-6136	4 1/4	5 11/16	3 1/4	5 31/32	2 13/16	4 1/16	2 5/8	3 9/16	JHW8-1XS	JHW7-1C / JHW8-2E
JHW8-6138	4 5/16	5 25/32	3 1/4	6 1/32	2 7/8	4 9/32	2 5/8	3 21/32	JHW8-1XS	JHW7-1C / JHW8-2E
JHW8-6140	4 3/8	5 27/32	3 1/4	6 3/32	2 29/32	4 7/32	2 5/8	3 21/32	JHW8-1XS	JHW7-1C / JHW8-2E
JHW8-6144	4 1/2	6	3 1/4	6 1/4	3 1/32	4 3/8	2 5/8	3 15/16	JHW8-1XS	JHW7-1C / JHW8-2E
JHW8-6148	4 5/8	6 1/16	3 1/4	6 13/16	3 1/16	4 7/16	3 1/2	4 3/32	JHW8-1XS	JHW7-1C / JHW8-2E
JHW8-6152	4 3/4	6 1/8	3 1/4	6 9/16	3 1/8	4 1/2	2 5/8	4	JHW8-1XS	JHW7-1C / JHW8-2E
JHW8-6156	4 7/8	6 3/4	3 1/4	7	3 1/8	5 7/64	3 1/2	4 19/32	JHW8-1XS	JHW7-1C / JHW8-2E
JHW8-6160	5	6 3/4	3 1/4	7 1/8	3 1/16	5 7/64	3 1/2	4 9/16	JHW8-1XS	JHW7-1C / JHW8-2E
JHW8-6172	5 3/8	7	3 1/4	7 5/16	3 1/4	5 1/8	4	4 29/32	JHW8-1XS	JHW7-1C / JHW8-2E
JHW8-6184	5 3/4	7	3 1/4	7 5/8	3 1/2	5 1/8	3 3/4	4 7/8	JHW8-1XS	JHW7-1C / JHW8-2E
JHW8-6196	6 1/8	7 1/4	5	8 1/2	3 11/16	5 3/8	4 1/2	5 1/16	JHW8-4XS	JHW9-1D / JHW8-2E
JHW8-6208	6 1/2	7 1/2	5	9 1/4	3 1/2	5 5/8	5	5 9/64	JHW8-4XS	JHW9-1D / JHW8-2E
JHW8-6220	6 7/8	7 7/8	5	9 1/4	3 7/8	6	4 3/4	5 33/64	JHW8-4XS	JHW9-1D / JHW8-2E
JHW8-6232	7 1/4	8 1/8	5	10	4 1/2	6 1/4	5 1/2	5 49/64	JHW8-4XS	JHW9-1D / JHW8-2E
JHW8-6244	7 5/8	8 1/4	5	10 3/4	4 13/16	6 3/8	6 1/2	5 57/64	JHW8-4XS	JHW9-1D / JHW8-2E
JHW8-6256	8	8 3/8	5	11	5 1/16	6 1/2	7	6 1/64	JHW8-4XS	JHW9-1D / JHW8-2E



JHW8-696

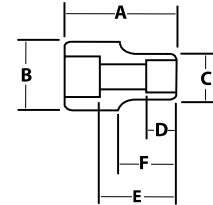

1-1/2" DRIVE

Fed. Spec: ANSI B107.2

Features

- SUPERTORQUE™ lobular openings for greater turning power without deforming the fastener
- Designed for maximum engagement on 6 point fasteners
- Suitable for use with pneumatic and electric impact wrenches
- Specially heat treated for impact use to provide long life, safety, and durability



Made in U.S.A.

SOCKETS AND DRIVE TOOLS



SCREWDRIVERS

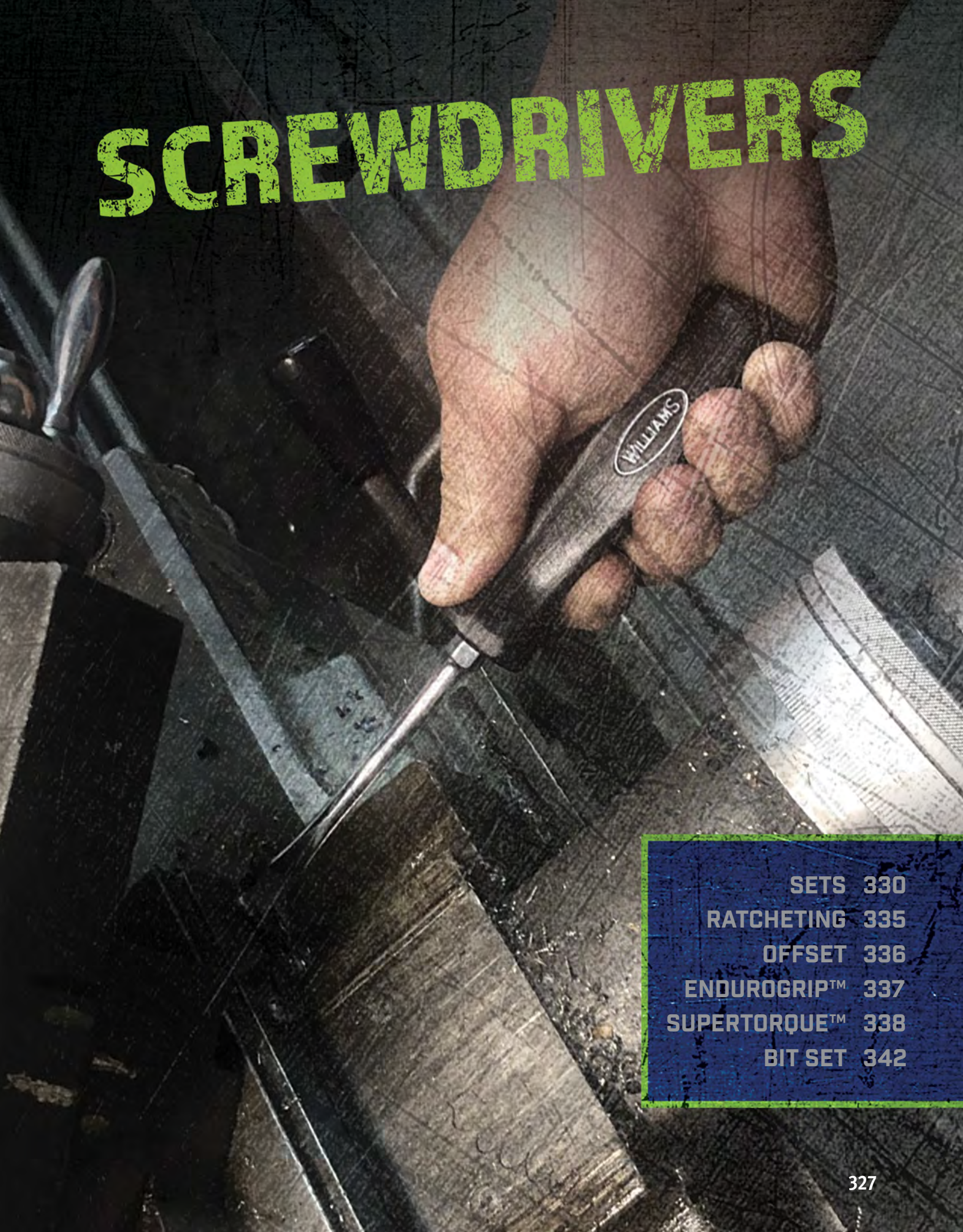

SETS	330
RATCHETING	335
OFFSET	336
ENDUROGRIP™	337
SUPERTORQUE™	338
BIT SET	342

WILLIAMS®

SUPERTORQUE™ SCREWDRIVERS



Hanging hole in the handle also permits T-bar insertion for transmission of additional force

3 component handle for maximum user comfort and force transmission

Double-shaped handle for use with both hands. Heavy duty design for maximum torque power



Indelible tip symbol by overflow for easy identification of the tip

Flat face prevents rolling

High performance, chrome plated alloy steel blade for high corrosion resistance

Laser marking on the blade (Size & COO)

8 Different Tip Styles Available

							
K Keystone Slotted	C Cabinet Slotted	P Phillips	T Torx	X Tamper-Torx	R Square/Robertson	N Nutdriver Hex	Z Pozidriv

Sand blasted tip for greater screw-tip adherence

SCREWDRIVERS

COMFORT, POWER AND VERSATILITY

ENDUROGRIP™ SCREWDRIVERS



ENDUROGRIP™
handle with thumb stop
allow for added turning
power without discomfort
or slippage

Hex bolsters on shafts
allow a wrench to be used
for extra turning power

Chrome blades prevent
corrosion and can be easily
cleaned

Blades are made from **special
alloy steel** for extra strength

Vapor-blasted tips grip fasteners and
prevent chipping, extending tool life

Flat face prevents rolling

3 Different Tip Styles Available



K
Keystone
Slotted



C
Cabinet
Slotted



P
Phillips

19 PIECE ENDUROGRIP™ AND SUPERTORQUE™ COMBINATION SCREWDRIVER SET



Premium Comfort Grip & Three Component handle with Black Oxide Tips

Product Code	Description
JHW100P-19MD	19 Piece ENDUROGRIP™ Combination Screwdriver Set

Contents Include:

Product Code	Overall Length (Inches)	Blade Length (Inches)	Tip
JHWSDE-43	6 1/16	3	Cabinet Slotted 3/16"
JHWSDE-46	9 11/16	6	Cabinet Slotted 3/16"
JHWSPR-C-18-3	6	3	Cabinet Slotted 1/8"
JHWSPR-C-18-4	9	4	Cabinet Slotted 1/8"
JHWSPR-C-52-6	11 3/4	6	Cabinet Slotted 3/32"
JHWSDR-22	6 1/8	3	Keystone Slotted 3/16"
JHWSDS-62	3 1/2	1 3/4	Keystone Slotted 1/4" Stubby
JHWSDR-24	7 7/8	4	Keystone Slotted 1/4"
JHWSDR-26	10 11/16	6	Keystone Slotted 5/16"
JHWSDR-28	12 11/16	8	Keystone Slotted 3/8"
JHWSDS-33	17 13/16	12	Keystone Slotted 3/8"
JHWSPR-P-0-3	6 1/2	3	Phillips® #0
JHWSPR-P-1-3	7 3/4	3	Phillips® #1
JHWSDP-1-3	6 1/4	3	Phillips® #1
JHWSDP-2-4	7 15/16	4	Phillips® #2
JHWSDP-2-8	12	8	Phillips® #2
JHWSDP-3-6	10 1/2	6	Phillips® #3
JHWSDP-4-6	10 3/4	8	Phillips® #4
JHWSDP-2-ST	3 1/2	1 1/2	Phillips® #2 Stubby

Features

- Set contains a comprehensive assortment of screwdrivers to get the job done
- Williams comfort grip handle with thumb stop allow for added turning power without discomfort or slippage



JHW100P-19MD

8 PIECE ENDUROGRIP™ MIXED SCREWDRIVER SET



Comfort-Grip Handle With Round Blade

Product Code	Description
JHW100P-8MD	8 Piece ENDUROGRIP™ Screwdriver Set

Contents Include:

Product Code	Overall Length (Inches)	Blade Length (Inches)	Tip
JHWSDR-24	7 7/8	4	Keystone Slotted 1/4"
JHWSDR-26	10 11/16	6	Keystone Slotted 5/16"
JHWSDR-28	12 3/4	8	Keystone Slotted 3/8"
JHWSDP-1-3	6 1/4	3	Phillips® #1
JHWSDP-2-4	7 15/16	4	Phillips® #2
JHWSDP-3-6	10 1/2	6	Phillips® #3
JHWSDE-43	6 11/16	3	Cabinet Slotted 3/16"
JHWSDE-46	9 11/16	6	Cabinet Slotted 3/16"

Features

- Contains 3 keystone slotted, 3 Phillips®, and 2 Cabinet Tip screwdrivers
- Comfort-grip handle with thumb stop allow for added turning power without discomfort or slippage
- Chrome blades prevent corrosion and can be easily cleaned
- Blades are made from special alloy steel for extra strength
- Vapor-blasted tips grip fasteners and prevent chipping, extending tool life
- Hex bolsters on shafts allow a wrench to be used for extra turning power



JHW100P-8MD



JHW100P-5MD

5 PIECE ENDUROGRIP™ MIXED SCREWDRIVER SET



Comfort-Grip Handle With Round Blade

Product Code	Description
JHW100P-5MD	5 Piece ENDUROGRIP™ Screwdriver Set Phillips® / Keystone Slotted Tips

Contents Include:

Product Code	Overall Length (Inches)	Blade Length (Inches)	Tip
JHWSDR-22	6 1/8	3	Keystone Slotted 3/16"
JHWSDR-24	7 7/8	4	Keystone Slotted 1/4"
JHWSDR-26	10 11/16	6	Keystone Slotted 5/16"
JHWSDP-1-3	6 1/4	3	Phillips® #1
JHWSDP-2-4	7 15/16	4	Phillips® #2



JHW100P-6SD

6 PIECE ENDUROGRIP™ KEYSTONE SLOTTED SCREWDRIVER SET



Comfort-Grip Handle

Product Code	Description
JHW100P-6SD	6 Piece ENDUROGRIP™ Keystone Slotted Screwdriver Set

Contents Include:

Product Code	Overall Length (Inches)	Blade Length (Inches)	Tip
JHWSDR-22	6 1/8	3	Keystone Slotted 3/16"
JHWSDR-24	7 7/8	4	Keystone Slotted 1/4"
JHWSDR-26	10 11/16	6	Keystone Slotted 5/16"
JHWSDR-28	12 11/16	8	Keystone Slotted 3/8"
JHWSDR-30	14 3/4	10	Keystone Slotted 7/16"
JHWSDS-33	17 13/16	12	Keystone Slotted 3/8"



JHW100P-6PD

6 PIECE ENDUROGRIP™ PHILLIPS® SCREWDRIVER SET



Comfort-Grip Handle With Round Blade

Product Code	Description
JHW100P-6PD	6 Piece ENDUROGRIP™ Phillips® Screwdriver Set

Contents Include:

Product Code	Overall Length (Inches)	Blade Length (Inches)	Tip
JHWSDP-1-3	6 1/4	3	Phillips® #1
JHWSDP-2-4	7 15/16	4	Phillips® #2
JHWSDP-2-8	12	8	Phillips® #2
JHWSDP-3-6	10 1/2	6	Phillips® #3
JHWSDP-4-6	10 3/4	6	Phillips® #4
JHWSDP-2-ST	3 1/2	1 1/2	Phillips® #2 Stubby



ENDUROGRIP™ Screwdrivers Feature

- Comfort-grip handle with thumb stop allow for added turning power without discomfort or slippage
- Chrome blades prevent corrosion and can be easily cleaned
- Blades are made from special alloy steel for extra strength
- Vapor-blasted tips grip fasteners and prevent chipping, extending tool life
- Hex bolsters on shafts allow a wrench to be used for extra turning power

12 PIECE SUPERTORQUE™ COMBINATION SCREWDRIVER SET



Three Component Comfort Grip Handles

Product Code	Description
JHWSPRS-12CKPT	12 Piece SUPERTORQUE™ Combination Screwdriver Set

Contents Include:

Product Code	Overall Length (Inches)	Blade Length (Inches)	Tip
JHWSPR-C-36-1	3 7/8	1 1/2	Cabinet Slotted 3/16"
JHWSPR-C-14-1	3 7/8	1 1/2	Cabinet Slotted 1/4"
JHWSPR-K-36-4	7 3/4	4	Keystone Slotted 3/16"
JHWSPR-K-14-4	8 1/4	4	Keystone Slotted 1/4"
JHWSPR-K-14-6	10 9/16	6	Keystone Slotted 1/4"
JHWSPR-K-56-6	10 9/16	6	Keystone Slotted 5/16"
JHWSPR-P-1-3	5 11/16	3	Phillips® #1
JHWSPR-P-2-1	3 7/8	1 1/2	Phillips® #2
JHWSPR-P-2-4	8 1/4	4	Phillips® #2
JHWSPR-P-3-6	10 9/16	6	Phillips® #3
JHWSPR-T-15-4	7 3/4	4	Torx® T15
JHWSPR-T-25-5	8 1/4	5	Torx® T25

Features

- Contains 2 cabinet slotted, 4 keystone slotted, 4 Phillips® and 2 TORX® screwdrivers
- 3 component handles provides a maximum comfort grip
- Size is shown on blade and tip style is shown on handle for easy identification
- Chrome blades prevent corrosion and can be easily cleaned
- Sand blasted tip for greater screw-tip adherence and high resistance against corrosion



JHWSPRS-12CKPT

8 PIECE SUPERTORQUE™ COMBINATION SCREWDRIVER SET

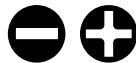

Three Component Comfort Grip Handles

Product Code	Description
JHWSPRS-8CKP	8 Piece SUPERTORQUE™ Combination Screwdriver Set

Contents Include:

Product Code	Overall Length (Inches)	Blade Length (Inches)	Tip
JHWSPR-C-14-1	3 7/8	1 1/2	Cabinet Slotted 1/4"
JHWSPR-K-36-4	7 3/4	4	Keystone Slotted 3/16"
JHWSPR-K-14-4	8 1/4	4	Keystone Slotted 1/4"
JHWSPR-K-56-6	10 9/16	6	Keystone Slotted 5/16"
JHWSPR-K-38-8	12 9/16	8	Keystone Slotted 3/8"
JHWSPR-P-1-3	5 11/16	3	Phillips® #1
JHWSPR-P-2-1	3 7/8	1 1/2	Phillips® #2
JHWSPR-P-2-4	8 1/4	4	Phillips® #2

Features

- Contains 1 cabinet slotted, 4 keystone slotted and 3 Phillips® screwdrivers
- 3 component handles provides a maximum comfort grip
- Size is shown on blade and tip style is shown on handle for easy identification
- Chrome blades prevent corrosion and can be easily cleaned
- Sand blasted tip for greater screw-tip adherence and high resistance against corrosion



JHWSPRS-8CKP



JHWSPRS-6CK

6 PIECE SUPERTORQUE™ COMBINATION SCREWDRIVER SET



Component Comfort Grip Handles

Product Code	Description
JHWSPRS-6CK	6 Piece SUPERTORQUE™ Combination Screwdriver Set

Contents Include:

Product Code	Overall Length (Inches)	Blade Length (Inches)	Tip
JHWSPR-C-36-1	3 7/8	1 1/2	Cabinet Slotted 3/16"
JHWSPR-C-14-1	3 7/8	1 1/2	Cabinet Slotted 1/4"
JHWSPR-K-14-4	8 1/4	4	Keystone Slotted 1/4"
JHWSPR-K-36-4	7 3/4	4	Keystone Slotted 3/16"
JHWSPR-K-56-6	10 9/16	6	Keystone Slotted 5/16"
JHWSPR-K-38-8	12 9/16	8	Keystone Slotted 3/8"

Features

- Contains 2 cabinet slotted and 4 keystone slotted screwdrivers
- 3 component handles provides a maximum comfort grip
- Size is shown on blade and tip style is shown on handle for easy identification
- Chrome blades prevent corrosion and can be easily cleaned
- Sand blasted tip for greater screw-tip adherence and high resistance against corrosion

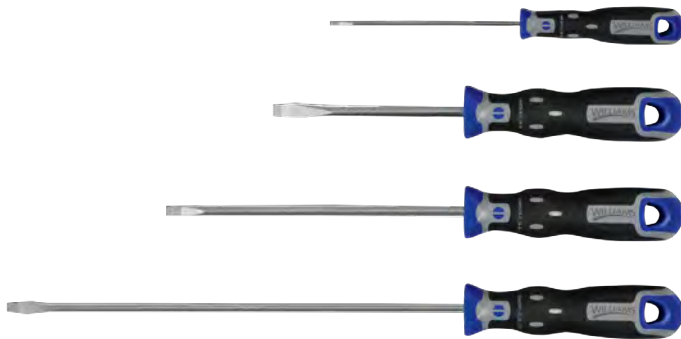

JHWSPRS-4C

4 PIECE SUPERTORQUE™ CABINET SLOTTED SCREWDRIVER SET



Three Component Comfort Grip Handles

Product Code	Description
JHWSPRS-4C	4 Piece SUPERTORQUE™ Cabinet Tip Screwdriver Set

Contents Include:

Product Code	Overall Length (Inches)	Blade Length (Inches)	Tip
JHWSPR-C-18-4	6 11/16	4	Cabinet Slotted 1/8"
JHWSPR-C-36-4	6 13/16	4	Cabinet Slotted 3/16"
JHWSPR-C-36-6	9 3/4	6	Cabinet Slotted 3/16"
JHWSPR-C-36-10	13 11/16	10	Cabinet Slotted 3/16"

Features

- 3 component handles provides a maximum comfort grip
- Size is shown on blade and tip style is shown on handle for easy identification
- Chrome blades prevent corrosion and can be easily cleaned
- Sand blasted tip for greater screw-tip adherence and high resistance against corrosion

6 PIECE SUPERTORQUE™ PHILLIPS® SCREWDRIVERS SET



Three Component Comfort Grip Handles

Product Code	Description
JHWSPRS-6P	6 Piece SUPERTORQUE™ Phillips® Screwdrivers Set

Contents Include:

Product Code	Overall Length (Inches)	Blade Length (Inches)	Tip
JHWSPR-P-1-1	3 7/8	1 1/2	Phillips® #1
JHWSPR-P-1-3	5 1/16	3	Phillips® #1
JHWSPR-P-2-1	3 7/8	1 1/2	Phillips® #2
JHWSPR-P-2-4	8 1/4	4	Phillips® #2
JHWSPR-P-2-8	12 1/8	8	Phillips® #2
JHWSPR-P-3-6	10 9/16	6	Phillips® #3

Features

- 3 component handles provides a maximum comfort grip
- Size is shown on blade and tip style is shown on handle for easy identification
- Chrome blades prevent corrosion and can be easily cleaned
- Sand blasted tip for greater screw-tip adherence and high resistance against corrosion

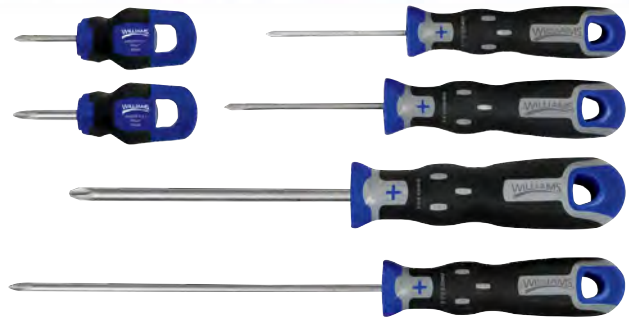

JHWSPRS-6P

6 PIECE SUPERTORQUE™ TORX® SCREWDRIVER SET



Three Component Comfort Grip Handles

Product Code	Description
JHWSPRS-6T	6 Piece SUPERTORQUE™ TORX® Screwdriver Set

Contents Include:

Product Code	Overall Length (Inches)	Blade Length (Inches)	Tip
JHWSPR-T-10-3	7 1/4	3	Torx® T10
JHWSPR-T-15-4	7 1/4	4	Torx® T15
JHWSPR-T-20-4	7 3/4	4	Torx® T20
JHWSPR-T-25-5	8 1/4	5	Torx® T25
JHWSPR-T-27-5	8 1/4	5	Torx® T27
JHWSPR-T-30-6	8 1/4	6	Torx® T30

Features

- 3 component handles provides a maximum comfort grip
- Size is shown on blade and tip style is shown on handle for easy identification
- Chrome blades prevent corrosion and can be easily cleaned
- Sand blasted tip for greater screw-tip adherence and high resistance against corrosion



JHWSPRS-6T



JHWWRS-1

MAGNETIC RATCHETING SCREWDRIVER



Comfort Grip Handle

Product Code	Overall Length (Inches)	Blade Length (Inches)
JHWWRS-1	9	4

Features

- Includes 5 bits: 2 slotted, #1 Phillips®, #2 Phillips®, and T-15 TORX®
- Ergonomically designed handle for greater user comfort and control
- Hi-impact plastic handle for durability and flexibility in all types of work applications
- Heavy-duty 3-way on-off-locked ratcheting mechanism allows consistent and smooth operation
- Powerful magnetic shank securely holds bit in place before, during and after the job application
- Stainless steel shank eliminates problems of chrome chipping or rust.
- Easy bit storage in handle
- Accepts all standard 1/4" hex shank bits

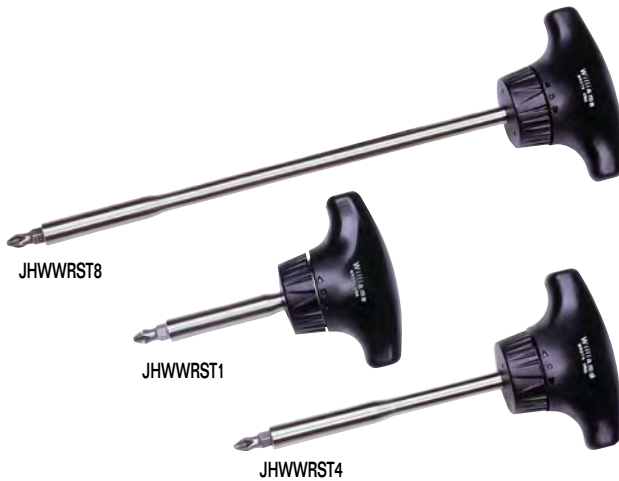

JHWWRST8

JHWWRST1

JHWWRST4

T-HANDLE RATCHETING SCREWDRIVERS



Comfort Grip T-Handles

Product Code	Overall Length (Inches)	Blade Length (Inches)
JHWWRST1	3 7/8	2
JHWWRST4	5 13/16	3 7/8
JHWWRST8	9 13/16	7 7/8

Features

- Includes #2 Phillips® bit
- Ergonomically designed T-Handle fits the palm and provides extra leverage
- Hi-impact plastic handle for durability and flexibility in all types of work applications
- Heavy-duty 3-way On-Off-Locked ratcheting mechanism allows consistent and smooth operation
- Stainless steel shank eliminates problems of chrome chipping or rust
- Accept all standard 1/4" hex shank bits



1/4" HEX SHANK BIT HOLDER

3-Component Handle

Product Code	Overall Length (Inches)	Bits Included
JHWSPR-0-14-5	9 ²⁹ / ₆₄	No

Features

- 3 component handle provides a maximum comfort grip



JHWSPR-0-14-5

MINI RATCHETING SCREWDRIVER

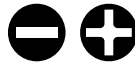

Satin Chrome Finish

Product Code	Overall Length (Inches)
807SXUSA	4

Features

- Smooth and consistent reverse ratcheting mechanism
- Perfect size for working in tight spaces and for hard to reach fasteners
- Tips are precision machined to fit precisely to fasteners



807SXUSA

OFFSET SCREWDRIVERS

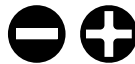

Cushion Grip Handle

Product Code	Overall Length (Inches)	Tip
JHW24101	4	Slotted 3/16" x PH1
JHW24102	4	Slotted 1/4" x PH2
JHW24103	6	Slotted 3/16" x PH3
JHW24104	4	Phillips® # 1 x # 2
JHW24105	8	Phillips® # 3 x # 4

Features

- Blades are made from special alloy steel for extra strength
- One piece tool steel construction
- Tips are 90 degree angled



JHW24101



JHWSDE-46



JHWSDR-24



JHWSDP-2-4

ENDUROGRIP™ CABINET SLOTTED SCREWDRIVERS



ENDUROGRIP™ Comfort Grip Handles and Blades

Product Code	Overall Length (Inches)	Blade Length (Inches)	Tip
JHWSDE-4	7 15/16	4	Cabinet Slotted 1/4"
JHWSDE-8	11 15/16	12	Cabinet Slotted 1/4"
JHWSDE-43	6 11/16	3	Cabinet Slotted 3/16"
JHWSDE-46	9 11/16	6	Cabinet Slotted 3/16"
JHWSDE-50	13 3/4	10	Cabinet Slotted 3/16"
JHWSDE-53	6 13/64	3	Cabinet Slotted 1/8"

Features

- Comfort-grip handle with thumb stop allow for added turning power without discomfort or slippage
- Hi-polish chrome blades prevent corrosion and can be easily cleaned
- Vapor-blasted tips grip fasteners and prevent chipping, extending tool life
- Blades are made from special alloy steel for extra strength



Made in U.S.A.

ENDUROGRIP™ KEYSTONE SLOTTED SCREWDRIVERS



ENDUROGRIP™ Comfort Grip Handles and Blades

Product Code	Overall Length (Inches)	Blade Length (Inches)	Tip
JHWSDS-62	3 1/2	1 3/4	Keystone Slotted 1/4"
JHWSDR-22	6 1/8	3	Keystone Slotted 3/16"
JHWSDR-24	7 7/8	4	Keystone Slotted 1/4"
JHWSDR-26	10 11/16	6	Keystone Slotted 5/16"
JHWSDR-28	12 11/16	8	Keystone Slotted 3/8"
JHWSDR-30	14 3/4	10	Keystone Slotted 7/16"
JHWSDS-33	17 13/16	12	Keystone Slotted 3/8"

Features

- Comfort-grip handle with thumb stop allow for added turning power without discomfort or slippage.
- Hi-polish chrome blades prevent corrosion and can be easily cleaned.
- Vapor-blasted tips grip fasteners and prevent chipping, extending tool life.
- Blades are made from special alloy steel for extra strength.
- *SDS-33 features 3/8" heavy-duty square shank



Made in U.S.A.

ENDUROGRIP™ PHILLIPS® SCREWDRIVERS



ENDUROGRIP™ Comfort Grip Handles and Blades

Product Code	Overall Length (Inches)	Blade Length (Inches)	Tip
JHWSDP-1-3	6 1/4	3	Phillips® #1
JHWSDP-2-4	7 15/16	4	Phillips® #2
JHWSDP-2-8	12	8	Phillips® #2
JHWSDP-3-6	10 1/2	6	Phillips® #3
JHWSDP-4-6	10 3/4	6	Phillips® #4
JHWSDP-2-ST	3 3/8	1 1/2	Phillips® #2 Stubby

Features

- Comfort-grip handle with thumb stop allow for added turning power without discomfort or slippage
- Hi-polish chrome blades prevent corrosion and can be easily cleaned
- Vapor-blasted tips grip fasteners and prevent chipping, extending tool life
- Blades are made from special alloy steel for extra strength
- Hex bolsters on shafts allow a wrench to be used for extra turning power



Made in U.S.A.

SUPERTORQUE™ KEYSTONE SLOTTED SCREWDRIVERS



Three Component Comfort Grip Handles

Product Code	Overall Length (Inches)	Blade Length (Inches)	Tip
JHWSR-K-14-4	8 1/4	4	Keystone Slotted 1/4"
JHWSR-K-14-5	9 3/4	5	Keystone Slotted 1/4"
JHWSR-K-14-6	10 3/16	6	Keystone Slotted 1/4"
JHWSR-K-36-4	7 3/4	4	Keystone Slotted 3/16"
JHWSR-K-36-6	9 3/4	6	Keystone Slotted 3/16"
JHWSR-K-36-9	12 11/16	9	Keystone Slotted 3/16"
JHWSR-K-38-12	16 1/2	12	Keystone Slotted 3/8"
JHWSR-K-38-8	12 3/16	8	Keystone Slotted 3/8"
JHWSR-K-56-6	10 9/16	6	Keystone Slotted 5/16"
JHWSR-K-56-7	12 3/16	8	Keystone Slotted 5/16"
JHWSR-K-72-4	8 3/4	4	Keystone Slotted 7/32"
JHWSR-K-72-6	10 3/4	6	Keystone Slotted 7/32"

Features

- 3 component handles provides a maximum comfort grip
- Size is shown on blade and tip style is shown on handle for easy identification
- Chrome blades prevent corrosion and can be easily cleaned
- Sand blasted tip for greater screw-tip adherence and high resistance against corrosion

SUPERTORQUE™ CABINET SLOTTED SCREWDRIVERS



Three Component Comfort Grip Handles

Product Code	Overall Length (Inches)	Blade Length (Inches)	Tip
JHWSR-C-14-1	3 1/4	1	Cabinet Slotted 1/4"
JHWSR-C-36-1	3 7/8	1 1/2	Cabinet Slotted 3/16"
JHWSR-C-18-3	6	3	Cabinet Slotted 1/8"
JHWSR-C-36-4	6 13/16	4	Cabinet Slotted 3/16"
JHWSR-C-32-3	7	3	Cabinet Slotted 3/32"
JHWSR-C-94-3	7 3/4	3	Cabinet Slotted 9/64"
JHWSR-C-52-4	8 3/4	4	Cabinet Slotted 5/32"
JHWSR-C-18-4	9	4	Cabinet Slotted 1/8"
JHWSR-C-94-5	9 3/4	5	Cabinet Slotted 9/64"
JHWSR-C-36-6	9 3/4	6	Cabinet Slotted 3/16"
JHWSR-C-14-6	10 3/4	6	Cabinet Slotted 1/4"
JHWSR-C-52-6	11 3/4	6	Cabinet Slotted 5/32"
JHWSR-C-18-8	12 1/2	8	Cabinet Slotted 1/8"
JHWSR-C-36-10	13 11/16	10	Cabinet Slotted 3/16"

Features

- 3 component handles provides a maximum comfort grip
- Size is shown on blade and tip style is shown on handle for easy identification
- Chrome blades prevent corrosion and can be easily cleaned
- Sand blasted tip for greater screw-tip adherence and high resistance against corrosion



JHWSR-K-56-7



JHWSR-C-18-4



JHWSR-C-36-1



JHWSRP-P-1-1



JHWSRP-P-2-4



JHWSRP-Z-2-4

SUPERTORQUE™ PHILLIPS® SCREWDRIVERS



Three Component Comfort Grip Handles

Product Code	Overall Length (Inches)	Blade Length (Inches)	Tip
JHWSRP-P-1-1	3 ⁷ / ₈	1 ¹ / ₂	Phillips® #1
JHWSRP-P-2-1	3 ⁷ / ₈	1 ¹ / ₂	Phillips® #2
JHWSRP-P-1-3	5 ¹¹ / ₁₆	3	Phillips® #1
JHWSRP-P-2-4	8 ¹ / ₄	4	Phillips® #2
JHWSRP-P-0-3	6 ¹ / ₂	3	Phillips® #0
JHWSRP-P-2-6	10 ³ / ₁₆	6	Phillips® #2
JHWSRP-P-3-6	10 ⁹ / ₁₆	6	Phillips® #3
JHWSRP-P-2-8	12 ¹ / ₈	8	Phillips® #2
JHWSRP-P-1-8	12 ³ / ₄	8	Phillips® #2

Features

- 3 component handles provides a maximum comfort grip
- Size is shown on blade and tip style is shown on handle for easy identification
- Chrome blades prevent corrosion and can be easily cleaned
- Sand blasted tip for greater screw-tip adherence and high resistance against corrosion

SUPERTORQUE™ POZIDRIV® SCREWDRIVERS



Three Component Comfort Grip Handles

Product Code	Overall Length (Inches)	Blade Length (Inches)	Tip
JHWSRP-Z-0-3	7 ¹ / ₄	3	Pozidriv® #0
JHWSRP-Z-1-3	7 ³ / ₄	3	Pozidriv® #1
JHWSRP-Z-2-4	8 ³ / ₄	4	Pozidriv® #2
JHWSRP-Z-3-6	10 ³ / ₄	6	Pozidriv® #3

Features

- 3 component handles provides a maximum comfort grip
- Size is shown on blade and tip style is shown on handle for easy identification
- Chrome blades prevent corrosion and can be easily cleaned
- Sand blasted tip for greater screw-tip adherence and high resistance against corrosion

SUPERTORQUE™ TAMPER-RESISTANT TORX® SCREWDRIVERS



Three Component Comfort Grip Handles

Product Code	Overall Length (Inches)	Blade Length (Inches)	Tip
JHWSR-X-10-3	7 3/8	3	Tamper Resist Torx® T10
JHWSR-X-15-4	7 1/2	4	Tamper Resist Torx® T15
JHWSR-X-20-4	8	4	Tamper Resist Torx® T20
JHWSR-X-25-5	8	5	Tamper Resist Torx® T25
JHWSR-X-27-5	8 3/4	5	Tamper Resist Torx® T27
JHWSR-X-30-6	8 3/4	6	Tamper Resist Torx® T30
JHWSR-X-40-6	11 5/8	6	Tamper Resist Torx® T40

Features

- 3 component handles provides a maximum comfort grip
- Size is shown on blade and tip style is shown on handle for easy identification
- Chrome blades prevent corrosion and can be easily cleaned
- Sand blasted tip for greater screw-tip adherence and high resistance against corrosion

SUPERTORQUE™ TORX® SCREWDRIVERS



Three Component Comfort Grip Handles

Product Code	Overall Length (Inches)	Blade Length (Inches)	Tip
JHWSR-T-6-3	6	3	Torx® T6
JHWSR-T-7-3	6 1/4	3	Torx® T7
JHWSR-T-8-3	6 3/8	3	Torx® T8
JHWSR-T-9-3	7 1/4	3	Torx® T9
JHWSR-T-10-3	7 3/8	3	Torx® T10
JHWSR-T-15-4	7 1/2	4	Torx® T15
JHWSR-T-20-4	8	4	Torx® T20
JHWSR-T-25-5	8	5	Torx® T25
JHWSR-T-27-5	8 3/4	5	Torx® T27
JHWSR-T-30-6	8 3/4	6	Torx® T30
JHWSR-T-40-6	11 1/2	6	Torx® T40
JHWSR-T-45-6	11 1/2	6	Torx® T45

Features

- 3 component handles provides a maximum comfort grip
- Size is shown on blade and tip style is shown on handle for easy identification
- Chrome blades prevent corrosion and can be easily cleaned
- Sand blasted tip for greater screw-tip adherence and high resistance against corrosion



JHWSR-X-20-4



JHWSR-T-20-4

SUPERTORQUE™ ROBERTSON® SCREWDRIVERS



Three Component Comfort Grip Handles

Product Code	Overall Length (Inches)	Blade Length (Inches)	Tip
JHWSR-R-1-4	8	4	Robertson® #1 (5, 6, 7)
JHWSR-R-2-5	8	5	Robertson® #2 (8, 9, 10)
JHWSR-R-3-6	8 3/4	6	Robertson® #3 (12, 14)

Features

- 3 component handles provides a maximum comfort grip
- Size is shown on blade and tip style is shown on handle for easy identification
- Chrome blades prevent corrosion and can be easily cleaned
- Sand blasted tip for greater screw-tip adherence and high resistance against corrosion



JHWSR-R-3-6

JHWSR-N-7-6

SUPERTORQUE™ NUTDRIVERS, SAE

Three Component Comfort Grip Handles

Product Code	Overall Length (Inches)	Blade Length (Inches)	Point Size
JHWSR-N-5-6	10	6	5
JHWSR-N-6-6	10	6	6
JHWSR-N-7-6	10	6	7
JHWSR-N-8-6	10	6	8
JHWSR-N-9-6	10	6	9

Features

- 3 component handles provides a maximum comfort grip
- Size is shown on blade and tip style is shown on handle for easy identification
- Chrome blades prevent corrosion and can be easily cleaned
- Sand blasted tip for greater screw-tip adherence and high resistance against corrosion

72 PIECE BIT SET

Product Code	Description
JHW24900	72 Piece Bit Set

Contents Include:

Hex (10)



Size	QTY	Length
1/4	2	1"
3/16	2	1"
5/16	2	1"
3/8	2	1"
7/32	2	1"

Phillips® (13)



Size	QTY	Length
1	3	1"
2	4	1"
3	2	1"
1	1	2"
2	2	2"
3	1	2"

Pozidriv® (7)



Size	QTY	Length
2	3	1"
3	2	1"
2	1	2"
3	1	2"

Square (6)



Size	QTY	Length
2	2	1"
3	2	1"
2	2	2"

Slotted Tip (12)



Size	QTY	Length
6-8	3	1"
8-10	2	1"
10-12	2	1"
12-14	1	1"
8-10	2	2"
10-12	1	2"
12-14	1	2"

TORX® (15)



Size	QTY	Length
7	1	1"
8	1	1"
10	1	1"
15	1	1"
20	1	1"
25	1	1"
27	1	1"
30	1	1"
30	2	1"
40	2	1"
15	1	2"
20	1	2"
25	1	2"

Nut Driver (8)

Size	QTY	Length
1/4	1	1"
11/32	1	1"
3/16	1	1"
3/8	1	1"
5/16	1	1"
5/32	1	1"
7/16	1	1"
9/32	1	1"

Hex Magnetic Holder (1)

Description
Hex Magnetic Holder



JHW24900

Features

- S2 material for higher torque, optimum durability and performance
- All parts are engineered and produced according to ANSI standard
- The set also includes a magnetic bit holder allowing for quick change of driving bits
- Folding case design is compact and robust with pivoting dual bit holders that allow for easy and quick access to the accessories
- Industrial case is made from a highly durable, plastic material

PLIERS, CLAMPS AND PIPE TOOLS

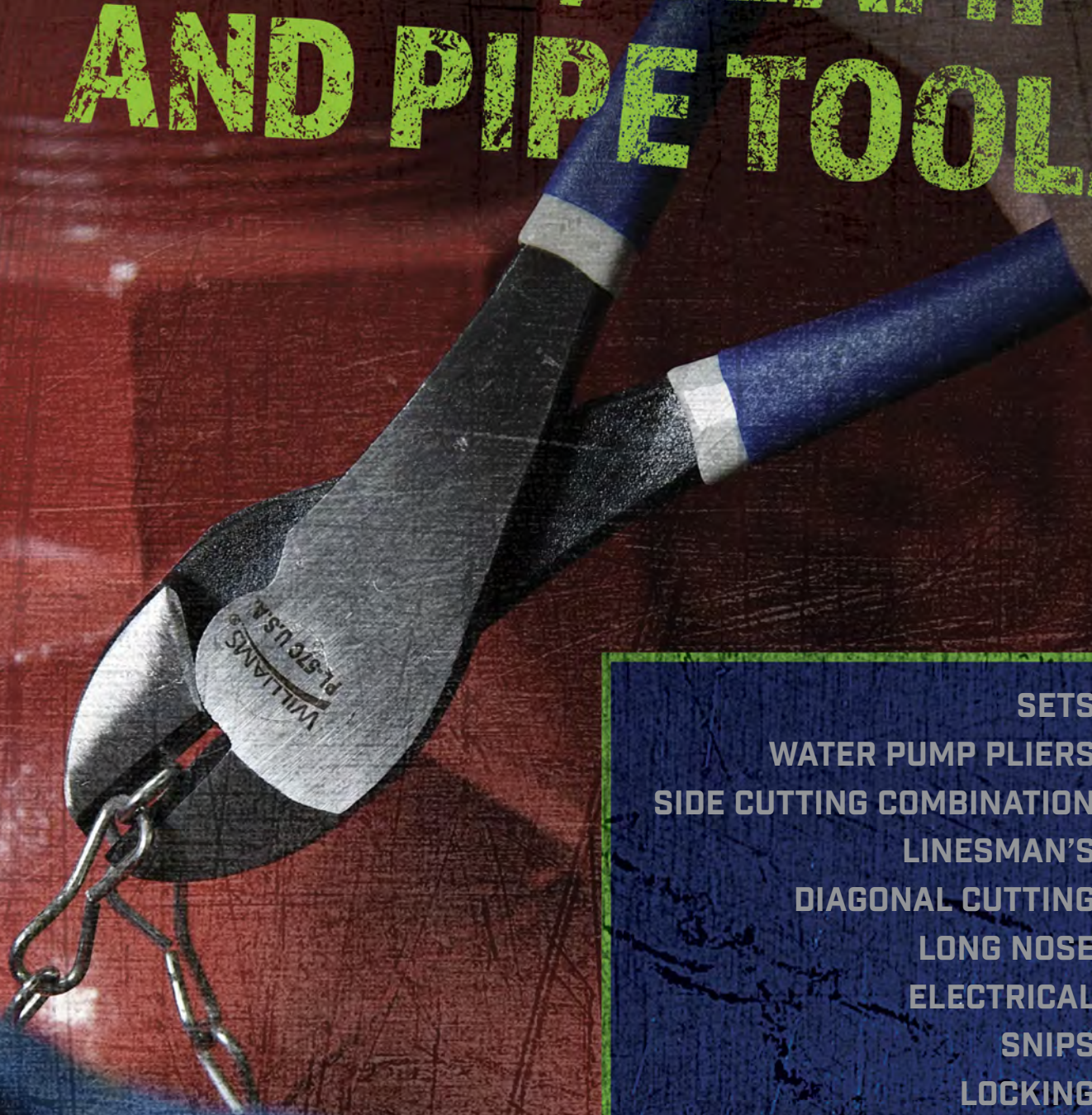

SETS	346
WATER PUMP PLIERS	348
SIDE CUTTING COMBINATION	349
LINESMAN'S	350
DIAGONAL CUTTING	351
LONG NOSE	353
ELECTRICAL	356
SNIPS	357
LOCKING	359
C-CLAMPS	365
PIPE WRENCHES	366
PIPE TOOLS	368

SIDE CUTTING COMBINATION PLIERS

Ergonomically designed two-component handles provide durability and a comfortable, secure, non-slip grip

High-leverage joint placement to reduce the required cutting force

Joint design ensures a smooth joint action

Heavy-duty design - high performance tool steel construction adds extra strength

On/Off return spring for higher comfort and higher frequency cutting may be turned off for storage in belt or pocket

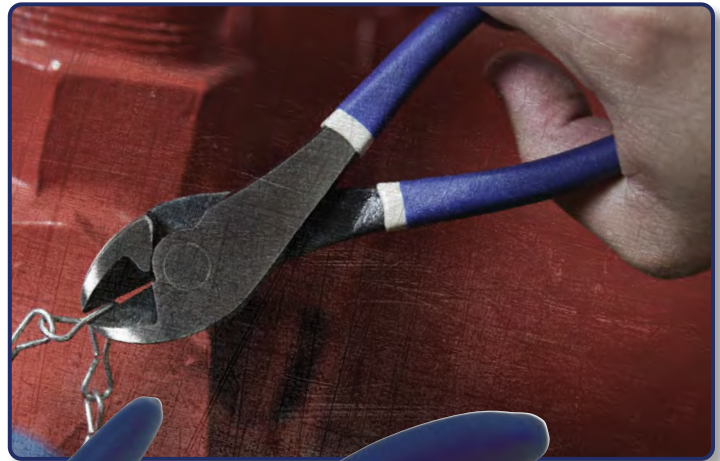

HIGH LEVERAGE DIAGONAL CUTTING PLIERS

Induction hardened cutting edges

Double-dipped plastic handles are designed to cut wire with ease

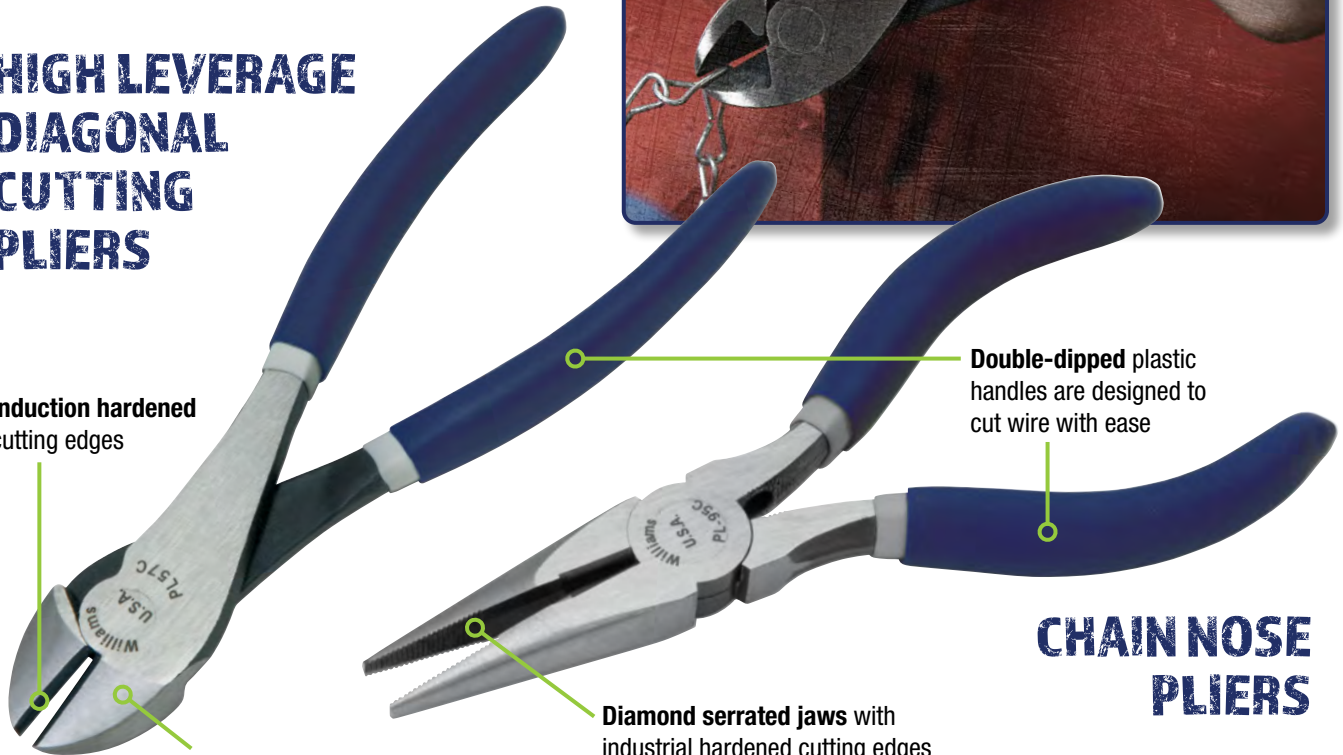

Polished heads resist rust and corrosion, extending the tool life

Diamond serrated jaws with industrial hardened cutting edges

CHAIN NOSE PLIERS

PLIERS, CLAMPS AND PIPE TOOLS

ADJUSTABLE JOINT PLIERS

Hardened jaws and teeth for exceptionally tough gripping surface

Wide, deep opening jaws have flat and pipe grip jaw so one pair of pliers can be used for more jobs

Double-dipped plastic handles are designed to cut wire with ease



**SECURED GRIP.
ASSURED SUCCESS.**

PIPE WRENCHES

Scale on wrench indicates pipe diameter



Heavy duty construction for strength and durability

C-CLAMPS

Powder coated frame resists rust

I-Beam design for extra strength

Drop-forged and heat treated for maximum strength and greater rigidity

Copper plated screw resists weld splatter

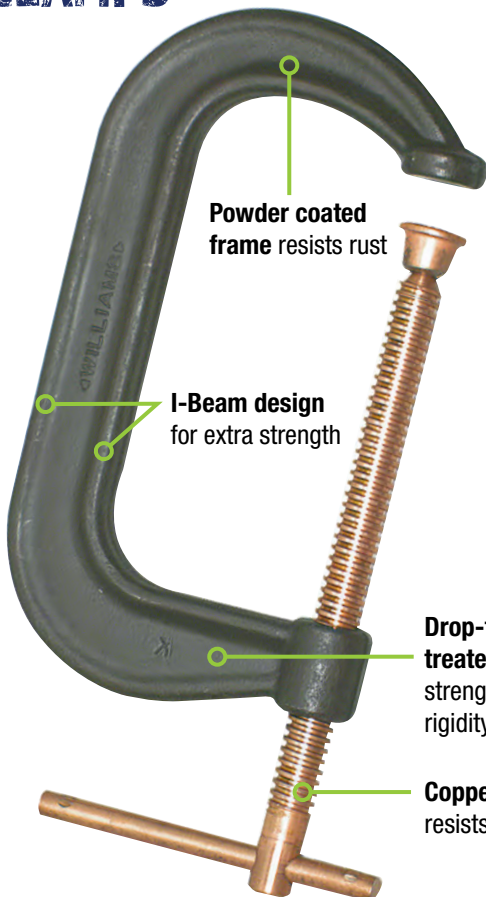



17 PIECE COMBINATION PLIER SET

Product Code	Description
JHWPLS-17	17 Piece Combination Plier Set

Contents Include:

Product Code	Description	Handle Type
JHWPL-8C	8" Slip Joint	Double Dipped Plastic Handles
JHWPL-1520C	9 3/4" Groove Joint	Double Dipped Plastic Handles
JHWPL-1524C	15 3/4" Groove Joint	Double Dipped Plastic Handles
JHWPL-47C	7" Heavy Duty Diagonal Cutting	Double Dipped Plastic Handles
JHWPL-126C	6 1/4" Curved Chain Nose	Double Dipped Plastic Handles
JHWPL-98C	8" long nose	Double Dipped Plastic Handles
JHW23503	8 1/4" Multi-Purpose Wire Cutter	Double Dipped Plastic Handles with Curved Wire Cutter
JHW23542	5 1/2" Mini Wire Cutter	Double Dipped Plastic Handles with Curved Wire Cutter
JHWPL-209X	9" Heavy Duty Linesman	Double Dipped Plastic and Bi-Mold Comfort Grip Handles
JHW2628G-7	7" Side Cutting Combination	Ergonomically Designed Handles
JHW6224	10" Water Pump	Double Dipped Plastic Handles
JHW2979D-7	7" Nut Gripping	Heavy Duty Design with PVC Grips
JHWPL-146C	6 1/2" Duck Bill	Double Dipped Plastic Handles
JHWPL-167	7 1/2" End Cutting	Double Dipped Plastic Handles
JHWPL-211BC	11" Bent Nose	Double Dipped Plastic Handles
JHWPL-211C	11" Long Reach Chain Nose	Double Dipped Plastic Handles
JHWPL-411C	11" Extra Long Diagonal	Double Dipped Plastic Handles

Features

- Double-dipped plastic handle grips are comfortable yet durable
- Ergo handles provide maximum gripping comfort



JHWPLS-17

6 PIECE GENERAL SERVICE PLIERS SET

Double-Dipped Plastic Handles

Product Code	Description
JHWPLS-6A	6 Piece General Service Pliers Set

Contents Include:

Product Code	Description
JHWPL-1519C	5" utility superjoint
JHWPL-1520C	10" utility superjoint
JHWPL-46C	6" diagonal cutting
JHWPL76C	6 1/2" chain nose side cutters
JHW2628G-6	6" side cutting combination
JHW23503	8 1/4" front-end stripper

Features

- Combines Williams' most popular pliers in to a single set
- 6 piece set packaged in a pouch



JHWPLS-6A



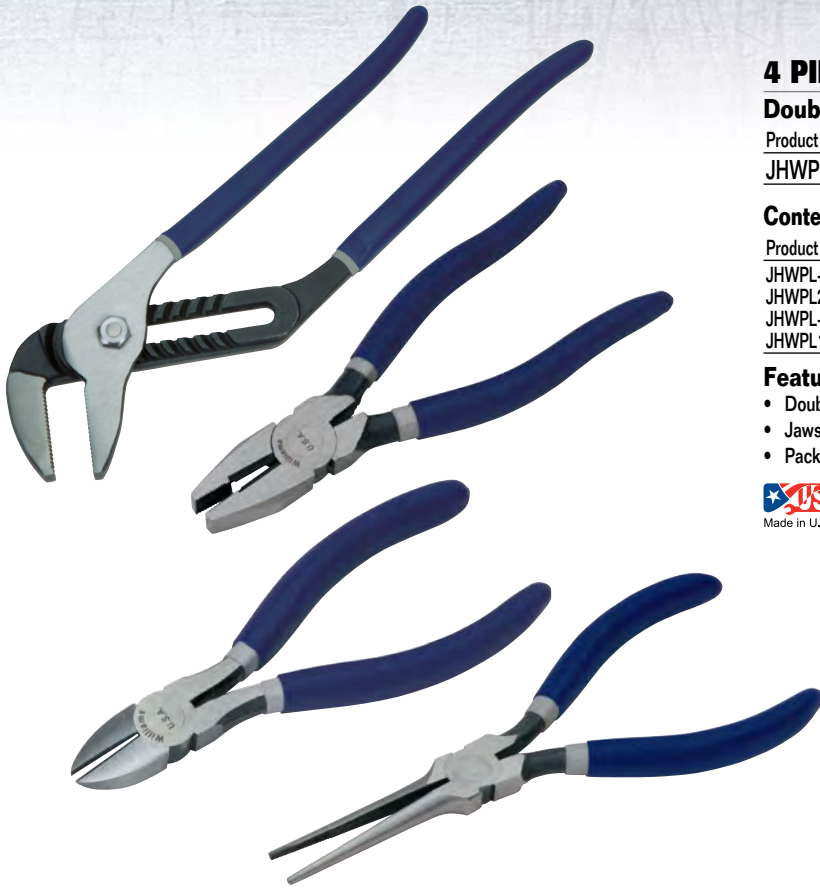

4 PIECE COMBINATION PLIERS SET

Double-Dipped Plastic Handles

Product Code	Description
JHWPLS-4GL	4 Piece Combination Pliers Set

Contents Include:

Product Code	Description
JHWPL-1523C	12" Utility Superjoint Pliers
JHWPL205C	8 1/2" Industrial Grade Linesman's Pliers
JHWPL-47C	7" Industrial Grade Diagonal Cutting Pliers
JHWPL116C	7" Long Nose Needle Pliers

Features

- Double-dipped plastic handle grips are comfortable yet durable
- Jaws are polished with rust-protective coating
- Packaged in a bag



Made in U.S.A.



4 PIECE COMBINATION PLIERS SET

Double-Dipped Plastic Handles

Product Code	Description
JHWPLS-4SG	4 Piece Combination Pliers Set

Contents Include:

Product Code	Description
JHWPL-8C	8" Combination Slip Joint Pliers
JHWPL-1520C	10" Utility Superjoint Pliers
JHWPL-47C	7" Industrial Grade Diagonal Cutting Pliers
JHWPL116C	7" Long Nose Needle Pliers

Features

- Double-dipped plastic handle grips are comfortable yet durable
- Jaws are polished with rust-protective coating
- Packaged in a bag



Made in U.S.A.



UTILITY SUPERJOINT PLIERS

Double-Dipped Plastic Handles

Features	Overall Length (Inches)	Maximum Opening (Inches)	Tip Width (Inches)
JHWPL-1519C	5	1/2	3/16
JHWPL-1520C	10	1 1/2	5/16
JHWPL-1523C	12	2 5/8	1/2
JHWPL-1524C	16	4	1/2

Features

- Multiple parallel jaw positions are locked in to proper groove for superior non-slip performance
- Serrated jaws for maximum gripping power
- Polished heads resist rust and corrosion, extending the tool life



Made in U.S.A.



JHWPL-1524C

WATER PUMP PLIERS

Product Code	Overall Length (Inches)	Maximum Jaw Opening (Inches)	Tip Width (Inches)
JHW6223	8	1 3/4	1/2
JHW6224	10	2 3/8	1/2
JHW6225	12	2 5/8	1/2

Features

- Hardened jaws and teeth for exceptionally tough gripping surface
- Comfortable two-component handles combines durability and a secure non-slip grip
- Wide, deep opening jaws have flat and pipe grip jaw so one pair of pliers can be used for more jobs



JHW6224

UNIVERSAL PLIERS WRENCHES

With Comfort Grip

Product Code	Overall Length (Inches)	Maximum Jaw Opening (Inches)	Pipe Maximum Diameter (Inches)
JHW140	8 7/16	1 3/16	3/4
JHW141	11	1 3/8	1
JHW142	14 1/2	2 1/16	1 1/2
JHW143	21 7/8	3 1/16	2 1/2
JHW144	28 3/8	4 3/8	3 1/2

Features

- Black oxide and anti-rust treated high alloy steel provide long life and durability
- Precision induction hardened jaws are designed with inwardly angled aggressive teeth
- Outer part of jaw is large toothed and used for maximum grip on large diameter pipes
- Inner part of jaw is fine toothed and used for maximum grip on small diameter pipes
- Commonly called a "Swedish Pipe Wrench", the small head makes them ideal for working in confined areas



JHW142



JHWPL-8C

COMBINATION SLIP-JOINT PLIERS

Double-Dipped Plastic Handles

Product Code	Overall Length (Inches)	Jaw Length (Inches)	Tip Width (Inches)
JHWPL-6C	6	1 ⁵ / ₃₂	³ / ₈
JHWPL-8C	8	1 ¹³ / ₃₂	³ / ₈
JHWPL-10C	10	1 ¹³ / ₃₂	¹ / ₂

Features

- Multiple parallel jaw positions are locked in to proper groove for superior non-slip performance
- Serrated jaws for maximum gripping power
- Polished heads resist rust and corrosion, extending the tool life
- Shear type wire cutter extends tool use



Made in U.S.A.



JHW2628G-6

SIDE CUTTING COMBINATION PLIERS

Handles with Bi-Molded Grips and On/Off Return Spring

Product Code	Overall Length (Inches)	Jaw Length (Inches)	Maximum Cutting Capacity (Inches)
JHW2628G-6	6 ¹ / ₄	1 ⁵ / ₁₆	¹ / ₁₆ Hard Steel
JHW2628G-7	7	1 ⁷ / ₁₆	⁵ / ₆₄ Hard Steel
JHW2628G-8	8	1 ¹ / ₂	⁷ / ₆₄ Hard Steel

Features

- On/off return spring for higher comfort and higher frequency cutting may be turned off when tool is kept in belt or pocket
- High-leverage joint placement to reduce the cutting force. Joint design ensures a smooth joint action
- Heavy-duty design - high performance tool steel construction adds extra strength
- Comfortable two-component handles which combines durability and a secure non-slip grip



JHW2979D-7

NUT GRIPPING PLIERS

Heavy-Duty Design with PVC Grips

Product Code	Overall Length (Inches)	Jaw Length (Inches)	Tip Width (Inches)
JHW2979D-7	7	¹ / ₂	⁷ / ₁₆

Features

- Conical jaws with teeth facing inward provide maximum gripping power
- Heavy-duty design combined with high performance tool steel construction adds extra strength



END CUTTING NIPPERS

Double-Dipped Plastic Handles

Product Code	Overall Length (Inches)	Cutting Blade Length (Inches)
JHWPLM-2C	4 1/2	15/32
JHWPL-167	7 1/2	13/16
JHW527D-6	6 1/4	1/4

Features

- Ideal for cutting wire or nails that are close to the work
- Polished heads resist rust and corrosion, extending the tool life
- The wide throat clearance, width of blades and angles of the cutting edges along with the handle leverage provide for easy, clean cutting or nipping



Made in U.S.A.



JHWPL-167

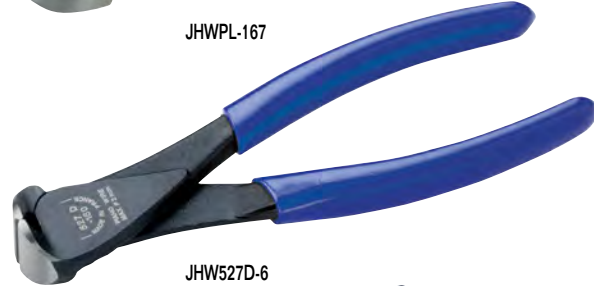

JHW527D-6

INDUSTRIAL GRADE LINESMAN'S PLIERS

Double-Dipped Plastic Handles

Product Code	Description	Overall Length (Inches)	Jaw Length (Inches)
JHWPL-204C	Electrician's	7	1/2
JHWPL205C	Electrician's	8 1/2	17/32
JHWPL-209X	New England	9 1/2	3/4

Features

- Designed for wiring, electrical equipment installation and maintenance for utility linemen
- Polished faces look good and resist corrosion
- Induction hardened cutting edges stay sharp longer
- Diamond serrated jaws provide solid grip on wire
- Double-dipped plastic handle grips are comfortable yet durable



Made in U.S.A.



JHWPL-204C



JHWPL-209X

INDUSTRIAL GRADE LINESMAN'S PLIERS

Supplied Without Grips

Product Code	Description	Overall Length (Inches)	Jaw Length (Inches)
JHWPL-208	Linesman's	8 1/2	17/32
JHWPL-209	New England	9 1/2	3/4

Features

- Designed for wiring, electrical equipment installation and maintenance for utility linemen
- Polished heads resist rust and corrosion, extending the tool life
- Induction hardened cutting edges stay sharp longer
- Diamond serrated jaws provide solid grip on wire
- Supplied without grips - handles are bare steel



Made in U.S.A.



JHWPL-208



JHWPL-209



JHWPL-57C



JHWPL-411C



JHWPL-46C



JHWPL-40CS



JHW21HDG-6



HIGH LEVERAGE DIAGONAL CUTTING PLIERS

Double-Dipped Plastic Handles

Product Code	Description	Overall Length (Inches)	Cutting Blade Length (Inches)
JHWPL-57C	High Leverage Head	7 1/4	15/16
JHWPL-411C	Extra Long Handle, Offset Head	11	1

Features

- Handles are designed to cut wire with ease
- Polished heads resist rust and corrosion, extending the tool life
- Induction hardened cutting edges



Made in U.S.A.

INDUSTRIAL GRADE DIAGONAL CUTTING PLIERS

Double-Dipped Plastic Handles

Product Code	Overall Length (Inches)	Cutting Blade Length (Inches)
JHWPL-44C	4	17/32
JHWPL-45C	5	11/16
JHWPL-46C	6	3/4
JHWPL-47C	7	11/16

Features

- Handles are designed to cut wire with ease
- Polished heads resist rust and corrosion, extending the tool life
- Induction hardened cutting edges
- Regular flush cutters are used for cutting hard wire



Made in U.S.A.

FLUSH CUT DIAGONAL CUTTING PLIERS WITH SPRING

Double-Dipped Plastic Handles

Product Code	Overall Length (Inches)	Cutting Blade Length (Inches)
JHWPLM-1CS	4 1/4	17/32
JHWPL-40CS	5	11/16

Features

- Handles are designed to cut wire with ease
- Polished heads resist rust and corrosion, extending the tool life
- Induction hardened cutting edges
- Flush cutters are used for close cutting of medium wire



Made in U.S.A.

HEAVY DUTY SIDE CUTTING PLIERS

Handles with Bi-Molded Grips and On/Off Return Spring

Product Code	Overall Length (Inches)	Jaw Length (Inches)	Maximum Cutting Capacity (Inches)
JHW21HDG-5.5	5 1/2	5/8	5/64 Piano Wire
JHW21HDG-6	6 1/4	3/4	3/32 Piano Wire
JHW21HDG-7	7	13/16	1/8 Piano Wire
JHW21HDG-8	7 3/4	13/16	1/8 Piano Wire

Features

- Distance from joint to center of cutting edges is reduced for greater leverage and increased cutting capacity
- Equipped with a patented return spring featuring an on/off function; turn on to reduce handle fatigue, off to store in tool belt or pocket
- Phosphate finish, anti-corrosion treated
- Heavy-duty cutting edge
- Screw joint that provides excellent running and accurate alignment of the cutting edges
- Distance from the joint to the center of the cutting edges is reduced: giving greater leverage and increased cutting capacity
- Metal frame designed to enhance accessibility in confined spaces
- Equipped with a patented return spring featuring an on/off function
- Induction hardened cutting edges
- Maximum comfort with minimum effort due to the handle design
- Comfortable two-component handles giving an excellent grip
- Self-opening handles when spring activated



FLAT NOSE PLIERS

Handles with Bi-Molded Grips and On/Off Return Spring

Product Code	Overall Length (Inches)	Jaw Length (Inches)	Width at Tip (Inches)
JHW2420G-5	5	7/8	5/8

Features

- Comfortable two-component handles which combines durability and a secure non-slip grip
- Unique on-off return spring: turn on to reduce hand fatigue, off to store in tool belt or pocket
- High performance tool steel construction adds extra strength
- Saw-toothed shaped, serrated jaws provide maximum gripping surface



JHW2420G-5

LONG NOSE PLIERS

Handles with Bi-Molded Grips and On/Off Return Spring

Product Code	Overall Length (Inches)	Jaw Length (Inches)	Maximum Cutting Capacity (Inches)
JHW2430G-5.5	5 1/2	1 1/2	3/64 Hard Steel
JHW2430G-6	6 1/4	1 15/16	1/16 Hard Steel
JHW2430G-8	8	1 15/16	1/16 Hard Steel

Features

- Comfortable two-component handles which combines durability and a secure non-slip grip
- Unique on-off return spring: turn on to reduce hand fatigue, off to store in tool belt or pocket
- High performance tool steel construction adds extra strength



JHW2430G-6

PLASTIC CUTTING DIAGONAL PLIERS

Double-Dipped Plastic Handles

Product Code	Overall Length (Inches)	Cutting Blade Length (Inches)
JHWPL-48C	6 3/8	7/8
JHWPL-49C	7 1/2	1 1/8

Features

- Polished heads resist rust and corrosion, extending the tool life
- Induction hardened cutting edges



Made in U.S.A.



JHWPL-48C

SIDE CUTTING PLIERS FOR PLASTIC

Handles with Bi-Molded Grips and On/Off Return Spring

Product Code	Overall Length (Inches)	Jaw Length	Maximum Cutting Capacity
JHW2101PG-7	6 1/4	3/4	1 1/2

Features

- Full flush cutting edge without beveling which is designed to smoothly cut all kinds of plastic parts such as the flash of plastic components
- Suitable for bridle cutting
- Comfortable two-component handles which combines durability and a secure non-slip grip
- Extra wide handle two-component material reduces stress and strain, and to increase comfort
- Lacquer finish protects against rust
- High Frequency hardened cutting edges hold their precision-sharpened cutting surfaces
- Unique on-off return spring: turn on to reduce handle fatigue, off to store in tool belt or pocket



JHW2101PG-7



JHW2427G-6

60° CURVED NOSE PLIERS

Handles with Bi-Molded Grips and On/Off Return Spring

Product Code	Overall Length (Inches)	Jaw Length (Inches)	Maximum Cutting Capacity (Inches)
JHW2427G-6	6 1/4	1 13/16	5/64 Hard Steel
JHW2427G-8	7	2 3/4	5/64 Hard Steel

Features

- Comfortable two-component handles which combines durability and a secure non-slip grip
- Unique on-off return spring: turn on to reduce hand fatigue, off to store in tool belt or pocket
- High performance tool steel construction adds extra strength



JHW2521G-6

LONG NOSE PLIERS

Handles with Bi-Molded Grips and On/Off Return Spring

Product Code	Overall Length (Inches)	Jaw Length (Inches)
JHW2521G-6	6 1/4	1 1/4

Features

- Comfortable two-component handles which combine durability and a secure non-slip grip
- Unique on-off return spring: turn on to reduce handle fatigue, off to store in tool belt or pocket
- Perfect for wire bending

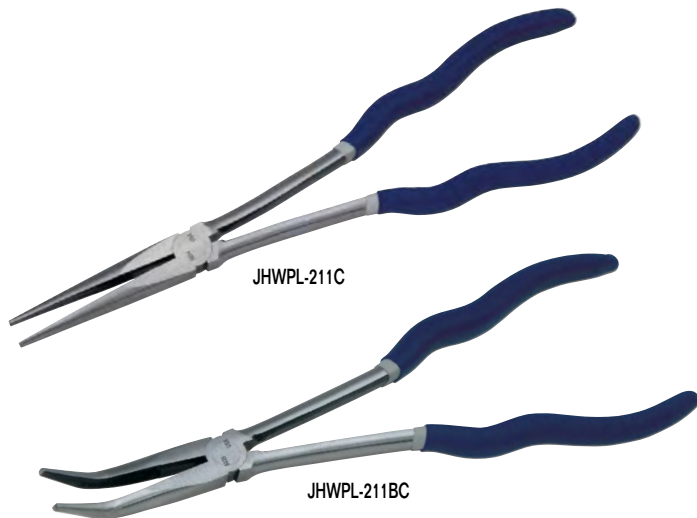

JHWPL-211C

JHWPL-211BC

EXTRA LONG REACH CHAIN NOSE PLIERS

Double-Dipped Plastic Handles

Product Code	Description	Overall Length (Inches)	Jaw Length (Inches)
JHWPL-211C	Straight Jaw	11	2 13/16
JHWPL-211BC	45° Bent Nose	11	2 9/16

Features

- Polished heads resist rust and corrosion, extending the tool life
- Extra long handles provide access into confined areas and greater holding power at the tip
- Bent nose model provides access to obstructed areas



JHWPL-98C

HIGH LEVERAGE CHAIN NOSE PLIERS

Double-Dipped Plastic Handles

Product Code	Overall Length (Inches)	Jaw Length (Inches)	Width at Tip (Inches)
JHWPL-98C	8	1 7/32	3/32

Features

- Polished heads resist rust and corrosion, extending the tool life
- Longer handles for more convenient use and greater jaw gripping power





CHAIN NOSE PLIERS

Double-Dipped Plastic Handles

Product Code	Description	Overall Length (Inches)	Jaw Length (Inches)
JHWPL-95C	Short Nose w/cutter	5 1/2	1 5/32
JHWPL-75C	Long Nose	6 3/4	2 5/16
JHWPL76C	Long Nose w/cutter	6 1/2	1 5/16
JHWPL-77C	Extra Long Nose w/cutter	7 1/2	1 29/32

Features

- Polished heads resist rust and corrosion, extending the tool life
- Diamond serrated jaws with industrial hardened cutting edges



Made in U.S.A.



JHWPL-95C

JHWPL-75C

THIN BENT CHAIN NOSE PLIERS

Double-Dipped Plastic Handles

Product Code	Description	Overall Length (Inches)	Jaw Length (Inches)
JHWPL-126C	73° Bent Thin Nose	6 1/4	1 1/4

Features

- Polished heads resist rust and corrosion, extending the tool life
- Serrated jaws for extra gripping power
- 73° bent nose model featured thin jaws angled to reach around obstacles and hard-to-reach spaces



Made in U.S.A.



JHWPL-126C

NEEDLE NOSE PLIERS

Double-Dipped Plastic Handles

Product Code	Description	Overall Length (Inches)	Jaw Length (Inches)
JHWPL-114CS	Short Nose	4 1/2	1
JHWPL116C	Long Nose	7	2 3/16

Features

- Polished heads resist rust and corrosion, extending the tool life
- Serrated jaws provide extra gripping power
- The JHWPL-114CS short nose model is supplied with a spring and is designed for close, fine electrical and mechanical work
- The JHWPL116C long nose model provides excellent gripping ability for use in tight, narrow places



Made in U.S.A.



JHWPL-114CS

JHWPL116C



JHWPL-146C

JHWPL-149C

DUCK BILL PLIERS

Double-Dipped Plastic Handles

Product Code	Description	Overall Length (Inches)	Jaw Length (Inches)
JHWPL-146C	Standard Jaw	6 1/2	2 1/16
JHWPL-149C	High Leverage	8	1 1/4

Features

- Jaws are polished with rust-protective coating
- Flat wide nose provides a better grip than the regular needle nose models



Made in U.S.A.



JHW23503

JHW23524

MULTI-PURPOSE COMBINATION WIRE TOOLS

Double-Dipped Plastic Handles with Curved Wire Cutter

Product Code	Description	Overall Length (Inches)	Nose Style
JHW23503	Front-end Stripper	8 1/4	Serrated Pliers
JHW23524	Front-end Crimper	8 3/4	Anvil Cutter

Features

- Crimp and strip wire sizes 10-22 AWG
- Double-dipped handles with air cushion pockets provide comfortable grip, reducing hand fatigue
- 23503 cuts 6 bolt sizes: 4-40 / 5-40 / 6-32 / 8-32 / 10-32 / 10-24
- 23524 cuts 5 bolt sizes: 4-40 / 6-32 / 8-32 / 10-32 / 10-24



Made in U.S.A.



ELECTRICAL MINI PLIERS

Double-Dipped Plastic Handles

Product Code	Description	Overall Length (Inches)	Capacity (AWG)
JHW23541	Mini Cutter	5 1/2	8
JHW23542	Mini Stripper	5 1/2	8-18 Solid/10-22 Stranded
JHW23543	Mini Crimper	5 1/2	10-22

JHW23080 3 Piece Electrical Mini Pliers Set in Pouch

Contents Include:

Product Code	Description	Product Code	Description
JHW23541	Mini Cutter	JHW23543	Mini Crimper
JHW23542	Mini Stripper		

Features

- Double-dipped handles with air cushion pockets provide comfortable grip, reducing hand fatigue
- Cutter is hardened and precision-ground for cutting stranded and solid copper and aluminum wire
- Stripper features up-front precision-ground stripping stations for exacting results in tight spaces
- Crimper features front-end crimp pockets guaranteed to be free from burrs and sharp edges



Made in U.S.A.



HEAVY DUTY FRONT END WIRE STRIPPERS

Double-Dipped Plastic Handles

Product Code	Overall Length (Inches)	Capacity (AWG-solid wire)	Capacity (stranded wire)
JHW23506	6 1/4	10-20	12-20
JHW23518	6 1/4	14-24	16-26
JHW23521	6 1/4	22-30	24-32

Features

- Double-dipped handles with air cushion pockets provide comfortable grip, reducing hand fatigue
- Spring-loaded handles speed work and reduce hand effort
- Serrated gripping jaws in nose for use as pliers
- 2-piece hardened steel pivot for long life service
- Lock protects cutting edges in storage



Made in U.S.A.



SUPER-DUTY FRONT END WIRE STRIPPERS WITH BOLT CUTTERS

Double-Dipped Plastic Handles with Curved Wire Cutter

Product Code	Overall Length (Inches)	Capacity (AWG-solid wire)	Capacity (stranded wire)
JHW23533	7 1/4	10-18	12-20
JHW23535	7 1/4	20-30	22-32

Features

- Double-dipped handles with air cushion pockets provide comfortable grip, reducing hand fatigue
- Longer, curved handles provide extra leverage and greater comfort
- Serrated gripping jaws in nose for use as pliers
- Built-in bolt cutters cleanly cut 6-32 and 8-32 screws



Made in U.S.A.





AVIATION SNIPS

Bi-Mold Comfort Grip Handles

Product Code	Cutting Direction	Overall Length (Inches)	Cut Length (Inches)	Cutting Capacity (cold-rolled/stainless)
JHW28201	Left	9 3/4	1 3/8	18 ga. CR / 22 ga. SS
JHW28203	Right	9 3/4	1 3/8	18 ga. CR / 22 ga. SS
JHW28205	Straight	9 13/16	1 1/2	18 ga. CR / 22 ga. SS

JHW28251 3 Piece Aviation Snips Set in Pouch

Contents Include:

Product Code	Description	Product Code	Description
JHW28201	Left-cut snips	JHW28205	Straight-cut snips
JHW28203	Right-cut snips		

Features

- Color-coded handles help quickly identify the cutting direction
- Bi-mold handles provide comfortable grip, reduces hand fatigue
- Meet ANSI and DIN standards



OFFSET AVIATION SNIPS

Bi-Mold Comfort Grip Handles

Product Code	Cutting Direction	Overall Length (Inches)	Cut Length (Inches)	Cutting Capacity (Cold-Rolled/Stainless)
JHW28231	Left and Straight	9 1/4	1 3/16	18 ga. CR / 22 ga. SS
JHW28233	Right and Straight	9 1/4	1 3/16	18 ga. CR / 22 ga. SS

JHW28253 2 Piece Offset Aviation Snips Set in Pouch

Contents Include:

Product Code	Description	Product Code	Description
JHW28231	Left and Straight Cut	JHW28233	Right and Straight Cut

Features

- Color-coded handles help quickly identify the cutting direction
- Bi-mold handles provide comfortable grip, reduces hand fatigue
- Meet ANSI and DIN standards
- Offset blades keeps user's hands above the work for safety and flow material away from blades for speed



SPECIALTY AVIATION SNIPS

Bi-Mold Comfort Grip Handles

Product Code	Style	Overall Length (Inches)	Cut Length (Inches)	Cutting Capacity (Cold-Rolled/Stainless)
JHW28211	Bulldog - Notch	9	1	16 ga. CR / 18 ga. SS
JHW28221	Long Cut - Straight	11 3/8	3	20 ga. CR / 26 ga. SS

JHW28255 2 Piece Specialty Aviation Snips Set in Pouch

JHW28255 2 Piece Specialty Snips Set. Includes one each Bulldog and Long Cut snips above.

Contents Include:

Product Code	Description	Product Code	Description
JHW28211	Bulldog - Notch	JHW28221	Long Cut - Straight

Features

- Bulldog snips notches and cuts rolled edges, seams, and thick sheet metal up to 16 gauge cold-rolled steel
- Color-coded handles help quickly identify the cutting direction
- Bi-mold handles provide comfortable grip, reduces hand fatigue
- Meet ANSI and DIN standards



STRAIGHT PATTERN TIN SNIPS

Double-Dipped Plastic Handles

Product Code	Overall Length (Inches)	Cutting Length (Inches)	Cutting Capacity (Cold-Rolled/Stainless)
JHW28301	7	1 3/16	24 ga. CR / 32 ga. SS
JHW28305	10	2	22 ga. CR / 28 ga. SS
JHW28307	12	2 3/4	20 ga. CR / 24 ga. SS
JHW28309	14	3	18 ga. CR / 22 ga. SS

JHW28351 2 Piece Straight Pattern Tin Snips Set in Pouch

Contents Include:

Product Code	Description	Product Code	Description
JHW28301	7" Tin Snips	JHW28307	12" Tin Snips

Features

- Forged steel blades
- Double-dipped handles provide comfortable grip, reducing hand fatigue
- Cut straight lines and wide curves
- Meet ANSI and DIN standards



JHW28307

CABLE CUTTER FOR FERROUS MATERIALS

With Rubber Grips

Product Code	Overall Length (Inches)	Cable Cutting Capacity (Inches)	Replacement Blade Kit
JHW2520	22 1/2	1 3/16 Aluminum/Copper with 1/4 Messenger Wire	2520-SH

Features

- Lightweight handles provide ease of control while offering solid durability
- Rubber grips offer control and comfort during working application
- Cutting notch below top cutting blades provided for cuts on ferrous material
- Replacement blade kit includes blades, screws, and nuts



JHW2520

CABLE CUTTER FOR NON-FERROUS MATERIALS

With Rubber Grips

Product Code	Overall Length (Inches)	Cable Cutting Capacity (Inches)
JHW2620-31	31 1/2	1 5/8 Aluminum/Copper

Features

- For non-ferrous material cutting only
- Lightweight handles provide ease of control while offering solid durability
- Rubber grips offer control and comfort during working application
- Replacement blade kit includes blades, screws, and nuts



JHW2620-31

CABLE TIE CUTTER

With Rubber Grips

Product Code	Overall Length (Inches)
JHWPL-1300	6 1/2

Features

- Suitable for cable ties rated up to 250 lbs
- Safely remove cable ties without harming bundled items



Made in U.S.A.



JHWPL-1300





JHWWTC-11

WIRE TWISTER / CUTTER

Produces Right Hand (clockwise) Twists

Product Code	Overall Length (Inches)	Jaw Length (Inches)	Cutting Blade Length (Inches)
JHWWTC-11	8.5	1 1/16	1/4
JHWWTC-45	6	1 1/16	1/16

Features

- Diamond-shaped, flat top jaw serrations hold wire firmly and resist nicking material being worked on
- Diagonal nose configurations & "mini" frame allows access in tight quarters
- Automatic return feature retracts automatically, speeding up operation use and reducing operator fatigue
- Heat-treated cutting edge holds it edge for cutting tough (up to .041) stainless steel and safety wire
- One hand operation allows for operator closing and locking with minimum of handle force
- High carbon alloy steel forging are used for maximum durability and long life



JHW23201

JHW23210



JHW23220

LOCKING PLIERS AND SET

Bi-Mold Comfort Grip Handles

Product Code	Overall Length (Inches)	Style
JHW23201	5	Curved Jaw with Cutter
JHW23202	7	Curved Jaw with Cutter
JHW23203	10	Curved Jaw with Cutter
JHW23210	7	Straight Jaw
JHW23211	10	Straight Jaw
JHW23220	6	Long Nose with cutter
JHW23221	9	Long Nose with cutter

Locking Pliers Sets

Product Code	Description
JHW23070	3 Piece Locking Pliers Set with Bi-Mold Comfort Grip Handles

Contents Include:

Product Code	Description
JHW23201	5" Curved Jaw Locking Pliers with Cutter
JHW23202	7" Curved Jaw Locking Pliers with Cutter
JHW23203	10" Curved Jaw Locking Pliers with Cutter

Product Code	Description
JHW23071	3 Piece Locking Pliers Set with Bi-Mold Comfort Grip Handles

Contents Include:

Product Code	Description
JHW23203	10" Curved Jaw Locking Pliers with Cutter
JHW23210	7" Straight Jaw Locking Pliers
JHW23220	6" Long Nose Locking Pliers with Cutter

Features

- Bi-mold handles provide comfortable grip, reducing hand fatigue
- Convenient one-hand release lever
- Heavy-duty jaw surfaces provide extra gripping power
- Packed in a pouch



JHW23070



JHW23071



LOCKING PLIERS

Curved Jaw with Wire Cutter Locking Pliers

Product Code	Overall Length (Inches)
JHW23301	5
JHW23302	7
JHW23303	10

Straight Jaw Locking Pliers

Product Code	Overall Length (Inches)
JHW23304	7
JHW23305	10

Long Nose with Wire Cutter Locking Pliers

Product Code	Overall Length (Inches)
JHW23309	6
JHW23310	9

Locking C-Clamps

Product Code	Overall Length (Inches)	Throat Depth	Capacity (Lbs.)
JHW23320	6	1 1/4"	450
JHW23321	11	2 1/4"	900

Locking C-Clamps with Swivel Pad

Product Code	Overall Length (Inches)	Throat Depth	Capacity (Lbs.)
JHW23222	6	1 5/16"	450
JHW23223	9	2 3/16"	900
JHW23224	11	2 1/4"	900
JHW23225	14	4 1/2"	700

Features

- Convenient one-hand release lever
- Heavy-duty jaw surfaces provide extra gripping power



JHW23303



JHW23305



JHW23309



JHW23320



JHW23222

LOCKING PLIERS SETS

JHW23072 3 Piece Locking Pliers Set

Contents Include:

Product Code	Description
JHW23301	5" Curved Jaw Locking Pliers with Cutter
JHW23302	7" Curved Jaw Locking Pliers with Cutter
JHW23303	10" Curved Jaw Locking Pliers with Cutter



JHW23072

JHW23074 4 Piece Locking Pliers Set

Contents Include:

Product Code	Description
JHW23301	5" Curved Jaw Locking Pliers with Cutter
JHW23303	10" Curved Jaw Locking Pliers with Cutter
JHW23309	6" Long Nose with Wire Cutter
JHW23310	9" Long Nose with Wire Cutter

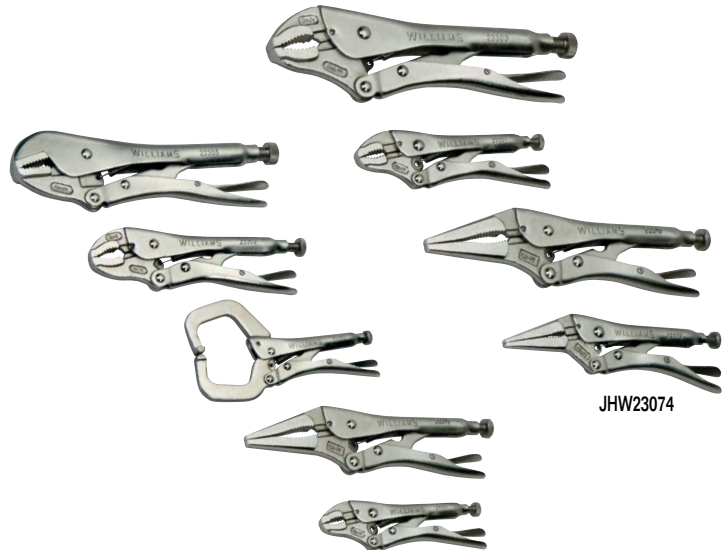

JHW23074

JHW23076 5 Piece Locking Pliers Set

Contents Include:

Product Code	Description
JHW23301	5" Curved Jaw Locking Pliers with Cutter
JHW23302	7" Curved Jaw Locking Pliers with Cutter
JHW23305	10" Straight Jaw
JHW23310	9" Long Nose with Wire Cutter
JHW23320	6" Locking C-Clamp

Features

- Convenient one-hand release lever
- Heavy-duty jaw surfaces provide extra gripping power

JHW23076



JHWPL-1622



JHWPL-1620



JHWPL-1621

SNAP RING PLIERS

Double-Dipped Plastic Handles

Product Code	Tip Size	Tip Angle (Degree)
JHWPL-1620	0.038	0°
JHWPL-1621	0.038	45°
JHWPL-1622	0.038	90°
JHWPL-1623	0.047	0°
JHWPL-1624	0.047	45°
JHWPL-1625	0.047	90°
JHWPL-1626	0.070	0°
JHWPL-1627	0.070	45°
JHWPL-1628	0.070	90°
JHWPL-1629	0.090	0°
JHWPL-1630	0.090	45°
JHWPL-1631	0.090	90°

Combination Internal/External Snap Ring Pliers Set Pliers set in a plastic carrying case

Contents Include:

Product Code	Description
JHWPL-1612	12 Piece Combination Internal/External Snap Ring Pliers Set

Set includes 1 each Snap Ring Plier listed above

Combination Internal/External Snap Ring Pliers Set Pliers set in a plastic carrying case

Contents Include:

Product Code	Description
JHWPL-1606	6 Piece Combination Internal/External Snap Ring Pliers Set

Set includes 1 each Snap Ring Pliers, PL-1620, PL-1622, PL-1623, PL-1625, PL-1626, PL-1628

Features

- Cushioned grip handles
- Pliers are convertible for use on internal and external snap rings
- Knurled center screw with spring for easy changing and secure hold



Made in U.S.A.



JHWPL-1612



JHWPL-1606



RETAINING RING PLIERS AND SET

Double-Dipped Plastic Handles

Product Code	Description	Minimum Opening (Ctr. To Ctr.)	Maximum Opening (Ctr. To Ctr.)	Tips Included (Each Plier Includes 2 of Each)
JHWPL-1600C1	Internal pliers with tips	3/32	25/32	0.035° 90° 0.045° 45°
JHWPL-1600C2	External pliers with tips	3/32	1 1/32	0.045° Straight 0.060° Straight

Snap Ring Pliers Set

Product Code	Description
JHWPL-1600C	Snap Ring Pliers Set

Contents Includes:

Product Code	Description
JHWPL-1600C1	PL-1600C-1 Internal Pliers
JHWPL-1600C2	PL-1600C-2 External Pliers

Replacement Tip Set Contents Includes:

Product Code	Description
JHWPL-1600C3	16 Piece Replacement tip set

Features

- Internal snap rings designed for use in housings, boxes, etc with bore diameters .375 to 1.750 inches
- External snap rings designed for use in shafts, studs, etc with shaft diameters .250 to 1.438 inches
- JHWPL-1600C1 and JHWPL-1600C2 each supplied with 8 tips (2 each: 90° x .035 and 45° x .045 angle tips and .045 and .060 straight tips)
- Made of high quality carbon steel with black-oxide finish to resist rust and other corrossions
- Tips heat treated for a secure grip
- Pliers provided with cushion grip handles
- Set consists of one internal and one external snap ring pliers and 16 tips in a pouch
- Tip set includes 4 each of interchangeable tips: 90° x .035 and 45° x .045 angle tips and .045 and .060 straight tips



JHWPL-1600C1



JHWPL-1600C2

CONVERTIBLE RETAINING RING PLIERS AND SET

Double-Dipped Plastic Handles

Product Code	Capacity (Max. Ring Dia.)	Tips Included (Includes 2 of Each)
23801	2"	0.039° Straight Tips (Yellow) 0.038° 90° Tips (Yellow) 0.047° Straight Tips (Green) 0.047° 90° Tips (Green) 0.074° Straight Tips (Copper)
JHW23803A	1"	0.023° Straight Tips (Red) 0.039° Straight Tips (Yellow) 0.038° 90° Tips (Yellow) 0.047° Straight Tips (Green) 0.047° 90° Tips (Green)

Retaining Ring Pliers Set

Product Code	Description
JHW23092	Retaining Ring Pliers Set

Contents Includes:

Product Code	Description
23801	2" Capacity Retaining Ring Pliers
JHW23803A	1" Capacity Retaining Ring Pliers

Replacement Tip Kits Contents Includes:

Product Code	Description
JHW23802A	Replacement Tip Kit Only for 23801A
JHW23804A	Replacement Tip Kit Only for 23803A

Features

- Easily convert for use on internal and external rings by moving convenient adjusting levers
- Each pliers includes five pairs of color-coded tips for maximum versatility
- Hex-shaped locking guides firmly hold tips in place
- Double-dipped handles with air cushion pockets provide comfortable grip, reducing hand fatigue
- Spring-loaded handles speed work



23801



JHW23803A





JHWPL-529

HEAVY DUTY RETAINING RING PLIERS & TIPS

Double-Dipped Plastic Handles

Product Code	Description	Minimum Opening (Ctr. To Ctr.)	Maximum Opening (Ctr. To Ctr.)
JHWPL-527	Internal snap ring pliers	5/16	1 13/32
JHWPL-528	External snap ring pliers	11/32	1 17/32

Tips for Heavy Duty Retaining Ring Pliers

Product Code	Description (Includes 2 each)
JHWPL-529A	0.108" Straight Tips
JHWPL-529B	0.108" 15° Tips
JHWPL-529C	0.108 45° Tips
JHWPL-529D	0.108 90° Tips
JHWPL-530A	0.120 Straight Tips
JHWPL-530B	0.120 15° Tips
JHWPL-530C	0.120 45° Tips
JHWPL-530D	0.120 90° Tips

Heavy Duty Retaining Ring Pliers Set JHWPL-529

Product Code	Contents Include:
JHWPL-527	Internal snap ring pliers
JHWPL-528	External snap ring pliers

Set includes 2 each of heavy duty tips listed above

Features

- Internal snap rings designed for use in housings, boxes, etc
- External snap rings designed for use in shafts, studs, etc
- Pliers supplied with spring ratchet lock assembly which allows the ring to be compressed or expanded with gradual adjustments which lock at the desired size without continued pressure on the handles
- Made of high quality carbon steel with black-oxide finish to resist rust and other corrossions
- Tips heat treated for a secure grip
- Tips not provided with pliers when pliers are ordered individually



JHWPL-527

JHWPL-528

FIXED TIP RETAINING RING PLIERS

Double-Dipped Plastic Handles

Product Code	Overall Length (Inches)	Jaw Length (Inches)	Tip Diameter (Inches)	Minimum Jaw Opening (Inches)	Maximum Jaw Opening
Internal					
JHWPL-531	5 1/2	7/8	0.038	3/32	2 3/8
JHWPL-532	6 1/2	1	0.070	3/32	2 31/32
External					
JHWPL-533	6 1/2	7/8	0.038	3/32	1 1/32
JHWPL-534	7	2 1/16	0.070	3/32	1 1/4

Features

- Internal - used for installing and removing internal retaining rings in a bore without damage to the ring
- External - used for installing and removing external retaining rings on a shaft without damage to the ring
- Manufactured from high carbon, heat treated steel
- Designed for accurate fit and long wear by precision forming and induction hardening.
- Finished with black oxide coating



LOCKING RING PLIERS

Black Jaws

Product Code	Overall Length (Inches)	Jaw Length (Inches)	Width at Tip (Inches)
JHWPL-1515	8	1 3/8	5/16

Features

- For spreading horseshoe lock washers and steel lock rings used on gear and bearing shafts





JHWCC-406C



JHWCC-406S



JHWCC-4AAW

DROP FORGED C-CLAMPS

Deep Throat Design, Copper Plated Screw

Product Code	Capacity (Inches)	Throat Depth (Inches)	Screw Diameter (Inches)	Min Test Load (lbs)
JHWCC-402C	2	2 11/32	1/2	3500
JHWCC-403C	3	2 3/4	1/2	3500
JHWCC-404C	4	3 3/16	3/4	6500
JHWCC-406C	6	4 1/8	3/4	6900
JHWCC-408C	8	5 3/16	3/4	6900
JHWCC-410C	10	6	3/4	8000
JHWCC-412C	12	6 1/2	7/8	9500

Features

- Copper plated screw resists weld splatter
- Drop-forged and heat treated for maximum strength and greater rigidity
- I-Beam design for extra strength
- Highly resistant to "springing"
- Acme threading



Made in U.S.A.

DROP FORGED C-CLAMPS

Deep Throat Design, Standard Screw

Product Code	Capacity (Inches)	Throat Depth (Inches)	Screw Diameter (Inches)	Min Test Load (lbs)
JHWCC-402S	2	2 11/32	1/2	3500
JHWCC-403S	3	2 3/4	1/2	3500
JHWCC-404S	4	3 3/16	3/4	6500
JHWCC-406S	6	4 1/8	3/4	6900
JHWCC-408S	8	5 3/16	3/4	6900
JHWCC-410S	10	6	3/4	8000
JHWCC-412S	12	6 1/2	7/8	9500

Features

- Black threaded screw with T-handle
- Drop-forged and heat treated for maximum strength and greater rigidity
- I-Beam design for extra strength
- Highly resistant to "springing"
- Acme threading



Made in U.S.A.

HEAVY SERVICE C-CLAMPS

Deep Throat Design, Standard Screw

Product Code	Maximum Capacity (Inches)	Minimum Capacity (Inches)	Throat Depth From Center (Inches)	Exterior Body Width (Inches)	Screw Diameter (Inches)	Screw Length Under Head (Inches)	Min Test Load (Lbs.)
JHWCC-1AAW	1 3/8	0	1 1/8	2 23/32	13/32	2 7/16	5,600
JHWCC1 1/2AAW	1 7/8	0	1 21/32	3 19/32	5/8	3 1/4	8,750
JHWCC-2AAW	2 11/32	0	1 7/8	4 1/4	23/32	4 1/8	12,500
JHWCC-3AAW	3 7/16	1/8	2 13/32	5 3/4	27/32	4 7/8	16,250
JHWCC-3LAAW **	3 7/16	0	2 1/2	5 3/4	27/32	5 3/4	16,250
JHWCC-4AAW	4 21/32	17/32	2 7/8	6 1/4	27/32	6	20,000
JHWCC-4LAAW **	4 21/32	0	2 7/8	6 1/4	27/32	7 1/4	20,000
JHWCC-5AAW	5 5/8	1/2	3 1/8	7	27/32	7 1/4	23,800
JHWCC-5LAAW **	5 5/8	0	3 1/8	7	27/32	8 7/8	23,800
JHWCC-6AAW	6 1/2	1 5/32	3 1/2	7 1/2	1 3/32	8	27,500
JHWCC-6LAAW **	6 1/2	0	3 1/2	7 1/2	1 3/32	10	27,500
JHWCC-8AAW	8 1/2	4	3 11/16	8 1/2	1 3/32	7 1/8	31,250
JHWCC-8LAAW **	8 1/2	0	3 11/16	8 1/2	1 3/32	11 5/8	31,250
JHWCC-10AAW	10 3/8	5 3/8	4 3/8	8 1/2	1 3/32	7 3/4	35,000
JHWCC-10LAAW **	10 3/8	0	4 5/16	8 1/2	1 3/32	14 3/8	35,000
JHWCC-12AAW	12 3/8	7 1/4	4 7/16	9 1/2	1 3/32	8 1/4	40,000
JHWCC-12LAAW **	12 3/8	0	4 1/4	9 1/2	1 3/32	16 7/16	40,000

** Where zero capacity is desired, the clamps with long screws should be ordered. These are indicated with an "L" in the product code.

Features

- Especially designed for heavy duty service, frames are drop-forged and heat-treated for maximum strength and reduced springing
- Screws are made of special grade steel and are heat-treated for added strength not found in typical case-hardened screws
- To tighten, the square headed screw must be turned with a wrench
- Ideal for the most demanding applications such as construction and heavy industry
- Square head screw allows tightening with wrench for extra heavy duty clamping requirements
- Greater anvil surface for gripping larger work pieces and for greater stability



Made in U.S.A.

UNIVERSAL PLIERS WRENCHES

With Comfort Grip

Product Code	Overall Length (Inches)	Maximum Jaw Opening (Inches)	Pipe Maximum Diameter (Inches)
JHW140	8 ⁷ / ₁₆	1 ³ / ₁₆	³ / ₄
JHW141	11	1 ³ / ₈	1
JHW142	14 ¹ / ₂	2 ¹ / ₁₆	1 ¹ / ₂
JHW143	21 ⁷ / ₈	3 ¹ / ₁₆	2 ¹ / ₂
JHW144	28 ³ / ₈	4 ³ / ₈	3 ¹ / ₂

Features

- Black oxide and anti-rust treated high alloy steel provide long life and durability
- Precision induction hardened jaws are designed with inwardly angled aggressive teeth
- Outer part of jaw is large toothed and used for maximum grip on large diameter pipes
- Inner part of jaw is fine toothed and used for maximum grip on small diameter pipes
- Commonly called a "Swedish Pipe Wrench", the small head makes them ideal for working in confined areas



JHW142

ALUMINUM STRAIGHT PIPE WRENCH

Aluminum, Heavy Duty

Product Code	Size		Pipe Capacity		Weight	
	in.	mm	in.	mm	lb.	kg
RIG31090	10	250	1 ¹ / ₂	40	1	0.4
R47057	12	300	2	50	2 ¹ / ₂	1.1
R31095	14	350	2	50	2 ¹ / ₂	1.1
R31100	18	450	2 ¹ / ₂	65	3 ³ / ₄	1.7
R31105	24	600	3	80	6	2.7
R31110	36	900	5	125	11	5.0
RIG31115	48	1200	6	150	18 ¹ / ₂	8.4

Features

- Professional strength in lightweight aluminum
- Offer durability and ease-of-use



Made in U.S.A.



RIG31090



R31020

STRAIGHT PIPE WRENCH

Product Code	Size		Pipe Capacity		Weight	
	in.	mm	in.	mm	lb.	kg
RIG31000	6	150	3/4	20	1/2	0.2
R31005	8	200	1	25	3/4	0.3
R31010	10	250	1 1/2	40	1 3/4	0.8
R31015	12	300	2	50	2 3/4	1.2
R31020	14	350	2	50	3 1/2	1.6
R31025	18	450	2 9/16	65	5 3/4	2.6
R31030	24	600	3	80	9 3/4	4.4
R31035	36	900	5	125	19	8.7
RIG31040	48	1200	6	150	34 1/4	15.6
RIG31045	60	1500	8	200	51 1/4	23.3

Features

- Sturdy, cast-iron housing and I-beam handle with full floating forged hook jaw, featuring self-cleaning threads with replaceable hook and heel jaws
- Heavy-duty pipe wrenches comply with federal specifications GGG-W65IE, Type II, Class A



PIPE WRENCHES

Aluminum, Heavy Duty



JHW13542

Product Code	Overall Length (Inches)	Maximum Jaw Opening (Inches)	Spare Parts		
			Hook Jaw	Heel Jaw & Pin	Knurl Nut
JHW13500	8	1 5/16	JHW13551	JHW13567	JHW13571
JHW13502	10	1 5/8	JHW13552	JHW13562	JHW13572
JHW13504	12	2 1/8	JHW13553	JHW13563	JHW13573
JHW13506	14	2 9/16	JHW13554	JHW13564	JHW13574
JHW13508	18	3 1/8	JHW13555	JHW13565	JHW13575
JHW13510	24	3 3/4	JHW13556	JHW13566	JHW13576
JHW13512	36	5	JHW13557	JHW13568	JHW13577
JHW13514	48	6	JHW13558	JHW13569	JHW13578

Pipe Wrench Set

Product Code	Contents Include:
JHW13542	3 Piece Aluminum Pipe Wrench Set. Includes 8", 12", and 18" wrenches

Features

- Aluminum pipe wrenches are approximately 40% lighter than cast iron
- Heavy duty construction for strength and durability
- Scale on wrench indicates pipe diameter

PIPE WRENCHES

Cast Iron, Heavy-Duty



JHW13544

Product Code	Overall Length (Inches)	Maximum Jaw Opening (Inches)	Spare Parts		
			Hook Jaw	Heel Jaw & Pin	Knurl Nut
JHW13516	6	7/8	JHW13550	JHW13560	JHW13570
JHW13518	8	1 5/16	JHW13511	JHW13567	JHW13571
JHW13520	10	1 5/8	JHW13552	JHW13562	JHW13572
JHW13522	12	2 1/8	JHW13553	JHW13563	JHW13573
JHW13524	14	2 9/16	JHW13554	JHW13564	JHW13574
JHW13526	18	3 1/8	JHW13555	JHW13565	JHW13575
JHW13528	24	3 3/4	JHW13556	JHW13566	JHW13576
JHW13530	36	5	JHW13557	JHW13568	JHW13577
JHW13532	48	6	JHW13558	JHW13569	JHW13578

Pipe Wrench Set

Product Code	Contents Include:
JHW13544	3 Piece Cast Iron Pipe Wrench Set. Includes 8", 12", and 18" wrenches

Features

- Heavy duty construction for strength and durability
- Scale on wrench indicates pipe diameter



FLANGE-JACKS

Tremendous Pressure With Minimum Effort

Product Code	Flange Diameter Capacity			
	* 125 Pound Cast Iron	* 150 Pound Cast Iron	* 250 Pound Cast Iron	* 300 Pound Cast Iron
JHWFJ-20	2 to 20	2 to 20	1 to 12	3/4 to 12
JHWFJ-30	16 to 48	18 to 24	12 to 30	12 to 24

Features

- Ideal for working on pipe lines and other applications involving flanges
- Makes gasket removal fast and easy
- Flanges are separated smoothly and evenly without damage to flange faces
- Flange jacks are sold only in pairs
- Eliminates danger from flying wedges and sparks caused by hammer blows
- Ideal for hard to reach locations



JHWFJ-20

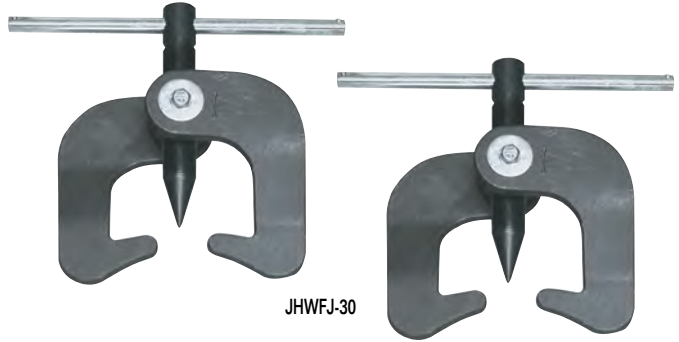

JHWFJ-30

STRAP WRENCH

Aluminum Handle

Product Code	Handle Length (Inches)	Maximum Diameter (Inches)	Strap Size (Inches)
JHW40221	12	8	1 1/8 x 30

Features

- Use on irregularly shaped objects where other wrenches won't work
- Useful for turning handwheels and other knurled handles
- Reduces risk of damage on plastic pipe and tubing
- Strap is made out of cotton



JHW40221



JHW43631

45° SINGLE FLARING TOOL

For Soft Tubing

Product Code	Description	O.D. Capacity (Inches)
JHW43631	45° Single Flaring Tool	$\frac{3}{16}$, $\frac{1}{4}$, $\frac{5}{16}$, $\frac{3}{8}$, $\frac{7}{16}$, $\frac{1}{2}$, & $\frac{5}{8}$

Features

- For soft copper, aluminum, and brass tubing
- Forged steel yoke and hardened flaring bar for durability
- Positive clamping action prevents tube slippage
- Self-centering yoke with swivel-type, hardened steel, chrome-plated flaring cone forms better flares with less effort
- Chrome plated to resist rust and corrosion



Made in U.S.A.



JHW43621

TRIPLE-HEAD TUBING BENDER

For Soft Tubing

Product Code	Description	O.D. Capacity (Inches)
JHW43621	Triple-Head Tube Bender	$\frac{3}{16}$, $\frac{1}{4}$, $\frac{5}{16}$, & $\frac{3}{8}$

Features

- For copper, aluminum, and thin-wall steel tubing
- Calibrated markings for making accurate left, right, and offset bends
- 90° start requires less effort, making bending fast and easy



Made in U.S.A.



JHWCW-4

PIPE CHAIN WRENCH

Heat Treated

Product Code	Pipe Diameter Minimum - Maximum (Pipe Size)	Handle Length (Inches)	Chain Length (Inches)
JHWCW-4	$\frac{3}{8}$ - 4	11	15

Features

- Forged handle is fully heat-treated
- Ideal for use in close quarters and where space is at a premium
- Successive "bites" can be taken without removal of wrench from the work piece
- Fully adjustable to fit any shape pipe



Made in U.S.A.



JHW40223

PIPE CHAIN WRENCH

Heat Treated

Product Code	Pipe Diameter Capacity	Handle Length (Inches)	Chain Length (Inches)
JHW40222	4	12	16
JHW40223	5	15	19
JHW40224	6	24	23

Features

- Forged strong I Beam handle
- Designed for working in confined areas when regular pipe wrenches will not fit, excellent for pipe fittings
- Portable and lightweight can be used for overhead and underground work



5/8" CAPACITY MINI-TUBING CUTTER

For Hard or Soft Copper Tubing, Brass, Stainless Steel, etc.

Product Code	Description	Cutting Capacity (Inches)	Overall Length (Inches)
JHW43603	Mini-Tubing Cutter	1/8 to 5/8	1 3/4
JHW43613	Replacement Cutter Wheel for 43603 (Pack of 5)		

Features

- Designed for use in tight access areas
- Enclosed feed screw assures smooth operation by minimizing contamination
- Corrosion resistant stainless steel rollers produce easier, smoother cuts



Made in U.S.A.



JHW43603

1-1/8" CAPACITY TUBING CUTTER

For Hard or Soft Copper Tubing, Brass, Stainless Steel, etc.

Product Code	Description	Cutting Capacity (Inches)	Overall Length (Inches)
JHW43605	1 1/8" Tubing Cutter	1/8 to 1 1/8	5
JHW43611	General Purpose Replacement Cutter Wheel (Pack of 10)		
JHW43615	Optional Cutter Wheel for Stainless Steel (Pack of 5)		

Features

- Enclosed hardened steel thrust-bearing mechanism assures smooth cuts and reliable operation
- Rugged aluminum alloy body looks good and handles well
- Foldaway hardened steel reamer removes inside burrs cleanly
- Includes (2) general-purpose cutter wheels



Made in U.S.A.



JHW43605

2-5/8" CAPACITY TUBING CUTTER

For Hard or Soft Copper Tubing, Brass, Stainless Steel, etc.

Product Code	Description	Cutting Capacity (Inches)	Overall Length (Inches)
JHW43607	2 5/8" Tubing Cutter	3/8 to 2 5/8	7 3/4 (Closed)
JHW43617	General Purpose Replacement Cutter Wheel for JHW43607 (Pack of 5)		

Features

- Ratchet feed mechanism speeds up cutting operations while extra-wide rollers stabilize the tubing
- Light-weight aluminum body
- Spare cutting wheel included under cap
- Cuts Schedule 40 PVC pipe up to 2" diameter with optional 43616 cutter wheel



Made in U.S.A.



JHW43607

PLASTIC AND RUBBER HOSE CUTTER

Compact and Light

Product Code	Description	Replacement Cutting Wheel
JHW43618	Plastic and rubber hose cutter	JHW43619

Features

- Cuts plastic tubing and non-metal reinforced hose
- Cuts sizes 1/16" to 1/2" and 1mm to 13mm O.D
- Spring loaded for safety
- Weighs only one ounce



Made in U.S.A.



JHW43618





HAMMERS, PUNCHES, CHISELS AND PRYBARS

DEADBLOW	374
BALL PEIN	375
SOFT FACE	376
SLEDGE	377
PUNCH & CHISEL SETS	378
CHISELS	381
PUNCHES	383
PRYBARS	385

WILLIAMS®

BALL PEIN HAMMERS

Hammer heads are drop-forged from specially selected steel and heat treated for dependable strength, hardness and uniformity.

Ideal for driving punches, chisels and other metal work

Wooden handles made from white hickory and clear lacquered and permanently wedged into the heads

Fiberglass handle has a cushion grip for greater comfort and safety



PUNCHES AND CHISELS

Protects user from hand injury

Heavy duty construction for strength and durability.



Holds chisel and punch securely



HAMMERS, PUNCHES, CHISELS AND PRYBARS

DELIVER A POWERFUL STRIKE WITH PRECISION SCREWDRIVER TYPE PRYBARS



LIGHTWEIGHT HANDLE PRYBARS

DEADBLOW HAMMERS

Ergonomically Designed Handles

Product Code	Weight (ozs.)	Overall Length (Inches)	Head Length (Inches)	Face Diameter (Inches)
JHWJHW-16	16	12	3 ¼	1 ⅞
JHWJHW-24	24	12 ¾	3 ¾	1 ¾
JHWJHW-32	32	13 ½	4 ¼	2
JHWJHW-48	48	15	4 ¾	2 ¼
JHWJHW-56	56	15 ¾	5 ⅞	2 ¾

Features

- Hard urethane construction resists cut damage to hammer head
- Head provides a non-marring contact surface that will not damage equipment
- Deadblow feature minimizes hammer bounce back, reducing fatigue and improving productivity



Made in U.S.A.



JHWJHW-24

BALL PEIN HAMMERS

Fiberglass Handles with Cushion Grip

Product Code	Weight (ozs.)	Handle Length (Inches)	Overall Length (Inches)	Face Diameter (Inches)
JHW20542	8	9 ½	10 ¾	7/8
JHW20543	12	10 ¼	11 ¾	7/8
JHW20544	16	11 ¼	13	1 ⅞
JHW20545	24	13	15	1 ¼
JHW20546	32	12 ¾	15	1 ¼

Features

- Ideal for driving punches, chisels and other metal work
- Fiberglass handle has a cushion grip for greater comfort and safety
- Hammer heads are drop-forged from specially selected steel and carefully heat treated for dependable strength, hardness and uniformity



JHW20543

BRASS HAMMERS

Fiberglass Handles with Cushion Grip

Product code	Weight (ozs.)	Handle Length (Inches)	Overall length (Inches)	Face Diameter (Inches)
JHWHSB-1.5A	1-½	10	12	1
JHWHSB-2.6A	2-½	10	12	1-¼
JHWHSB-3.8A	3-¾	10	12	1-⅝

Features

- Ideal for applications which require non-sparking conditions
- The flat surface brass head absorbs impact blows, reduces rebound and helps eliminate marred work surfaces
- Non-slip cushion grip provides greater comfort and safety



Made in U.S.A.



JHWHSB-3.8A



JHWHBP-4A



JHW20678



JHW20651



JHW20401

BALL PEIN HAMMERS

Wood Handle

Product code	Head Weight (ozs.)	Handle Length (Inches)	Overall length (Inches)	Face Diameter (Inches)
JHWHBP-5-0A	4	9 ³ / ₈	10 ⁷ / ₁₆	³ / ₄
JHWHBP-3-0A	8	10 ¹ / ₂	11 ³ / ₄	1
JHWHBP-2-0A	12	11 ¹ / ₈	12 ¹ / ₂	1 ¹ / ₈
JHWHBP-0A	16	12 ¹ / ₈	13 ⁵ / ₈	1 ¹ / ₄
JHWHBP-2A	24	13 ¹ / ₄	15 ¹ / ₈	1 ¹ / ₂
JHWHBP-4A	32	13 ¹ / ₄	15 ³ / ₁₆	1 ¹ / ₂
JHWHBP-6A	40	13 ⁵ / ₁₆	15 ⁵ / ₁₆	1 ⁵ / ₈
JHWHBP-8A	48	13 ¹ / ₂	15 ³ / ₈	1 ⁷ / ₈

Features

- Ideal for driving punches, chisels and other metal work
- Wooden handles, which are made from white hickory and clear lacquered, are permanently wedged in to the heads
- Hammer heads are drop-forged from specially selected steel and carefully heat treated for dependable strength, hardness, and uniformity
- Polished Face, Bevel & Pein



Made in U.S.A.

DRILLING HAMMER

Fiberglass Handles with Cushion Grip

Product Code	Weight (ozs.)	Handle Length (Inches)	Overall Length (Inches)
JHW20678	32	8 ¹ / ₂	10 ¹ / ₄

Features

- Handles are durable and comfortable
- Heavy duty construction for strength and durability

CROSS PEIN HAMMER

Fiberglass Handles with Cushion Grip

Product Code	Weight (ozs.)	Handle Length (Inches)	Overall Length (Inches)
JHW20651	48	13	15 ³ / ₄

Features

- Handles are durable and comfortable
- Heavy duty construction for strength and durability

CLAW HAMMERS

Fiberglass Handles with Cushion Grip

Product Code	Style	Weight (ozs.)	Handle Length (Inches)	Overall Length (Inches)
JHW20402	Ripping Claw	16	10 ³ / ₄	13
JHW20401	Curved Claw	20	10 ³ / ₄	13

Features

- Handles are durable and comfortable
- Heavy duty construction for strength and durability

8 PIECE SOFT-FACE HAMMER BODY AND TIP SET

Fiberglass Handles with Cushion Grip

Product Code	Description
JHWHSF-8SET	8 Piece Soft Face Hammer Body and Tip Set

Contents Include:

Product Code	Weight Class	Head Length (Inches)	Handle Length (Inches)	Overall Length (Inches)	Head Diameter (Inches)
JHWHSF-151A	16 oz.	1 ½	12 ½	14	1 ½

Product Code	Hardness	Tip Diameter (Inches)	Color
JHWHSF-15S	Soft	1 ½	Brown
JHWHSF-15M	Medium	1 ½	Red
JHWHSF-15N	Medium Hard	1 ½	Cream
JHWHSF-15H	Hard	1 ½	Black
JHWHSF-15SS	Steel	1 ½	Steel
JHWHSF-15B	Brass	1 ½	Brass

Plastic Storage Case

Features

- Handles are durable and comfortable
- Heavy duty construction for strength and durability
- Six interchangeable heads meet a number of various applications, including non-marring and non-sparking applications with selected head surfaces



SOFT-FACE HAMMER TIPS

Heavy Duty

Product Code	Hardness	Tip Diameter (Inches)	Color
Brown: Working with soft composites, plastics and soft alloy metals. Replaces vinyl hammer.			
JHWHSF-10S	Soft	1	Brown
JHWHSF-15S	Soft	1 ½	Brown
JHWHSF-20S	Soft	2	Brown
JHWHSF-25S	Soft	2 ½	Brown
JHWHSF-30S	Soft	3	Brown

Red: Working with soft composites, plastics and soft alloy metals. Replaces rawhide hammer.

JHWHSF-10M	Medium	1	Red
JHWHSF-15M	Medium	1 ½	Red
JHWHSF-20M	Medium	2	Red
JHWHSF-25M	Medium	2 ½	Red
JHWHSF-30M	Medium	3	Red

Cream: Working with soft composites, plastics and soft alloy metals. Replaces soft-metal hammer

JHWHSF-10N	Medium Hard	1	Cream
JHWHSF-15N	Medium Hard	1 ½	Cream
JHWHSF-20N	Medium Hard	2	Cream
JHWHSF-25N	Medium Hard	2 ½	Cream
JHWHSF-30N	Medium Hard	3	Cream

Black: Working with hard surface composites and other hard metals.

JHWHSF-10H	Hard	1	Black
JHWHSF-15H	Hard	1 ½	Black
JHWHSF-20H	Hard	2	Black
JHWHSF-25H	Hard	2 ½	Black
JHWHSF-30H	Hard	3	Black

Yellow: Working with hard surface composites and other hard metals, hardness is close to steel.

JHWHSF-10XH	Extra Hard	1	Yellow
JHWHSF-15XH	Extra Hard	1 ½	Yellow
JHWHSF-20XH	Extra Hard	2	Yellow
JHWHSF-25XH	Extra Hard	2 ½	Yellow
JHWHSF-30XH	Extra Hard	3	Yellow

Green: Working with soft composites, plastic and soft alloy metals. Replaces brass hammer

JHWHSF-10T	Tough	1	Green
JHWHSF-15T	Tough	1 ½	Green
JHWHSF-20T	Tough	2	Green
JHWHSF-25T	Tough	2 ½	Green
JHWHSF-30T	Tough	3	Green

Features

- Heavy duty construction for strength and durability



SOFT-FACE AND SHOT FILLED SOFT-FACE HAMMER BODY

Fiberglass Handles with Cushion Grip

Product Code	Weight Class (oz.)	Head Length (Inches)	Handle Length (Inches)	Overall Length (Inches)	Head Diameter (Inches)
JHWHSF-202A **	40	4 ½	10 ¾	13 ½	2
JHWHSF-100A	5	2	10 ¾	11 ½	1
JHWHSF-105A	8	2	10 ¾	11 ½	1
JHWHSF-150A	12	2 ½	10 13/16	12 5/16	1 ½
JHWHSF-151A	16	1 ½	12 ½	14	1 ½
JHWHSF-155A	20	2 ¾	10 7/8	12 7/16	1 ½
JHWHSF-200A	20	2 ½	11 5/8	13 ½	2
JHWHSF-205A	32	2 ½	11 9/16	13 ½	2
JHWHSF-250A	32	3 ¼	12 ½	14 ¾	2 ½
JHWHSF-255A	64	3 ¼	12 ¾	14 ¾	2 ½
JHWHSF-300A	56	3 ¾	12 7/8	14 ¾	3
JHWHSF-305A	96	3 ¾	11 ¾	14 ¾	3

Features

- **Shot filled head reduces rebound for safety and transmits more force to the work
- Handles are durable and comfortable
- Heavy duty construction for strength and durability
- Use with Soft-Face hammer tips below
- Match head diameter with tip diameter for proper fit
- Tips are not included with hammer body
- 5/16 – 18 thread size





JHWSH-8A

SLEDGE HAMMERS

Wood Handle

Product Code	Weight (lbs.)	Handle Length (inches)	Overall length (Inches)	Face Diameter (Inches)
JHWSH-2A	2	15	15	1 1/2
JHWSH-4A	4	15	15	2
JHWSH-6A	6	36	36	2 1/8
JHWSH-8A	8	36	36	2 1/8
JHWSH-10A	10	36	36	2 1/2
JHWSH-12A	12	36	36	2 5/8
JHWSH-16A	16	36	36	2 3/4

Replacement Handle Service Kit

Product code	Description	Weight (ozs.)	Length (Inches)
JHWSHHW-14A	Handle	14	15
JHWSHHW-32A	Handle	24	36

Features

- High carbon steel, heat treated and tempered head, with hickory handle



Made in U.S.A.

SLEDGE HAMMERS

Fiberglass Handle

Product Code	Weight Class (lbs.)	Handle Length (inches)	Overall length (Inches)	Face Diameter (Inches)
JHWSHF-4SA **	4	14	14	1 1/4
JHWSHF-8SA **	8	32	32	2
JHWSHF-12SA **	12	32	32	2 1/4
JHWSHF-2A	2	14	14	1 1/4
JHWSHF-3A	3	14	14	1 1/2
JHWSHF-4A	4	14	14	1 5/8
JHWSHF-6A	6	32	32	1 3/4
JHWSHF-8A	8	32	32	2
JHWSHF-10A	10	16	16	2 1/8
JHWSHF-10LA	10	32	32	2 1/8
JHWSHF-12A	12	32	32	2 1/4
JHWSHF-16A	16	24	24	2 5/8
JHWSHF-16LA	16	32	32	2 5/8
JHWSHF-20A	20	36	36	2 3/4

Replacement Handle Service Kit

Product Code	Description	Weight (lbs)	Length (Inches)
JHWSHHF-14A	Fiberglass	2 to 4	14
JHWSHHF-16A	Fiberglass	6 to 8	16
JHWSHHF-32A	Fiberglass	6 to 16	32
JHWSHHF-36	Fiberglass	20	36

Features

- ** Soft steel safety head is similar in hardness to brass
- ** Ideal replacement for Brass Head where non-sparking is not required
- Double faced head is hardened and tempered forged for maximum strength and durability
- All kits include replacement handle, pre-measured bonding mix, mix container and instructions



Made in U.S.A.

DEAD BLOW SLEDGE HAMMERS WITH REPLACEMENT TIPS

Product Code	Weight (lbs)	Handle Length (Inches)	Overall length (Inches)	Face Diameter (Inches)
JHWSHSFDB8	8	29	32	2

- Includes Two 4" Black Tips

4" Replacement Tip

Product code	Hardness	Color	Product code	Hardness	Color
JHWSHSFDB40S	Soft	Brown	JHWSHSFDB40N	Med/Hard	Cream
JHWSHSFDB40M	Medium	Red	JHWSHSFDB40H	Hard	Black
JHWSHSFDB40T	Tough	Green	JHWSHSFDB40XH	Extra hard	Yellow

Features

- Shot loaded dead blow heads deliver the impact of a steel hammer with little or no rebound
- Oversized head and striking face minimizes miss hits, applying force with greater impact and repeatability
- Strong yet light weight handles provide 90% of the total hammer weight at the head
- 4" Non-marring removable tips can be replaced when worn



JHWSHF-4A

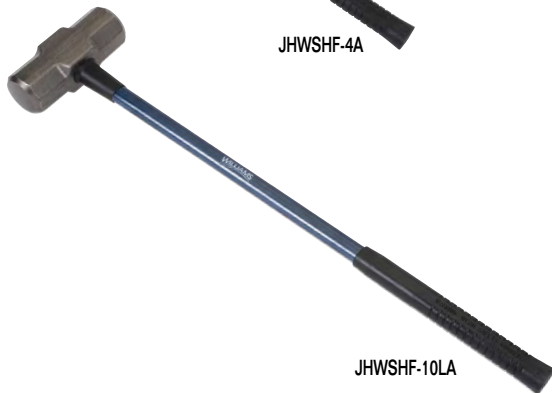

JHWSHF-10LA



JHWSHSFDB8



JHWSHSFDB40H

JHWSHSFDB40M

JHWSHSFDB40N

JHWSHSFDB40S

JHWSHSFDB40T

JHWSHSFDB40XH

27 PIECE PUNCH & CHISEL SET

Packed in a Pouch

Product Code	Description
JHWP-27	27 Piece Punch & Chisel Set

Contents Include:

Product Code	Description	Point Diameter (Inches)	Product Code	Description	Blade Width (Inches)
JHWP-3	Pin Punch	3/32	JHWC-8	Cold Chisel	1/4
JHWP-4	Pin Punch	1/16	JHWC-10	Cold Chisel	3/16
JHWP-5	Pin Punch	5/32	JHWC-12	Cold Chisel	3/8
JHWP-6	Pin Punch	3/16	JHWC-16	Cold Chisel	1/2
JHWP-8	Pin Punch	1/4	JHWC-20	Cold Chisel	5/8
JHWP-10	Pin Punch	5/16	JHWC-24	Cold Chisel	3/4
JHWP-13	Solid Punch	3/32	JHWC-28	Cold Chisel	7/8
JHWP-14	Solid Punch	1/8	JHWC-32	Cold Chisel	1
JHWP-15	Solid Punch	5/32	JHWC-36	Cold Chisel	1 1/8
JHWP-16	Solid Punch	3/16			
JHWP-17	Solid Punch	1/4	JHW28449	Punch and Chisel Holder	7/8" Capacity
JHWP-25	Long Taper Punch	3/32			
JHWP-26	Long Taper Punch	3/16			
JHWP-28	Long Taper Punch	1/4			
JHWP-30	Prick Punch	-			
JHWP-40	Center Punch	-			
JHWP-42	Center Punch	-			

Features

- Heavy duty construction for strength and durability
- Includes punch and chisel holder for safety



JHWP-27

17 PIECE PUNCH & CHISEL SET

Packed in a Pouch

Product Code	Description
JHWP-17	17 Piece Punch & Chisel Set

Contents Include:

Product Code	Description	Point Diameter (Inches)	Product Code	Description	Blade Width (Inches)
JHWP-4	Pin Punch	1/16	JHWC-10	Cold Chisel	5/16
JHWP-6	Pin Punch	3/16	JHWC-12	Cold Chisel	3/8
JHWP-8	Pin Punch	1/4	JHWC-16	Cold Chisel	1/2
JHWP-14	Solid Punch	1/8	JHWC-20	Cold Chisel	5/8
JHWP-15	Solid Punch	5/32	JHWC-24	Cold Chisel	3/4
JHWP-16	Solid Punch	3/16	JHWC-42	Cape Chisel	1/4
JHWP-25	Long Taper Punch	3/32	JHWC-62	Diamond Point Chisel	3/8
JHWP-28	Long Taper Punch	1/4			
JHWP-32	Prick Punch	-			
JHWP-40	Center Punch	-			

Features

- Heavy duty construction for strength and durability



JHWP-17



JHWP-8

8 PIECE PUNCH & CHISEL SET

Packed in a Pouch

Product Code	Description
JHWP-8	8 Piece Punch & Chisel Set

Contents Include:

Product Code	Description	Point Diameter (Inches)	Product Code	Description	Blade Width (Inches)
JHWP-4	Pin Punch	1/8	JHWC-10	Cold Chisel	5/16
JHWP-6	Pin Punch	3/16	JHWC-16	Cold Chisel	1/2
JHWP-8	Pin Punch	1/4	JHWC-24	Cold Chisel	3/4
JHWP-15	Solid Punch	5/32			
JHWP-40	Center Punch	-			

Features

- Heavy duty construction for strength and durability



Made in U.S.A.



JHWC-8

8 PIECE CHISEL SET

Packed in a Pouch

Product Code	Description
JHWC-8	8 Piece Chisel Set

Contents Include:

Product Code	Description	Blade Width (Inches)	Product Code	Description	Blade Width (Inches)
JHWC-40	Cape Chisel	3/16	JHWC-60	Diamond Point Chisel	1/4
JHWC-42	Cape Chisel	1/4	JHWC-62	Diamond Point Chisel	3/8
JHWC-44	Cape Chisel	5/16	JHWC-72	Round Nose Chisel	1/4
JHWC-46	Cape Chisel	3/8	JHWC-74	Round Nose Chisel	3/8

Features

- Heavy duty construction for strength and durability



Made in U.S.A.



JHWC-9

9 PIECE COLD CHISEL SET

Packed in a Pouch

Product Code	Description
JHWC-9	9 Piece Cold Chisel Set

Contents Include:

Product Code	Description	Blade Width (Inches)	Product Code	Description	Blade Width (Inches)
JHWC-8	Cold Chisel	1/4	JHWC-24	Cold Chisel	3/4
JHWC-10	Cold Chisel	3/16	JHWC-28	Cold Chisel	7/8
JHWC-12	Cold Chisel	3/8	JHWC-32	Cold Chisel	1
JHWC-16	Cold Chisel	1/2	JHWC-36	Cold Chisel	1 1/8
JHWC-20	Cold Chisel	5/8			

Features

- Heavy duty construction for strength and durability



Made in U.S.A.

17 PIECE PUNCH SET

Packed in a Pouch

Product Code	Description
JHWPS-17	17 Piece Punch Set

Contents Include:

Product Code	Description	Tip Diameter (Inches)	Product Code	Description	Tip Diameter (Inches)
PJHW-3	Pin Punch	3/32	JHWP-16	Solid Punch	3/16
JHWP-4	Pin Punch	1/8	JHWP-17	Solid Punch	1/4
JHWP-5	Pin Punch	5/32	JHWP-25	Long Taper Punch	5/32
JHWP-6	Pin Punch	3/16	JHWP-26	Long Taper Punch	3/16
JHWP-8	Pin Punch	1/4	JHWP-28	Long Taper Punch	1/4
JHWP-10	Pin Punch	5/16	JHWP-30	Prick Punch	-
JHWP-13	Solid Punch	3/32	JHWP-40	Center Punch	-
JHWP-14	Solid Punch	1/8	JHWP-42	Center Punch	-
JHWP-15	Solid Punch	5/32			

Features

- Heavy duty construction for strength and durability



Made in U.S.A.



JHWPS-17

4 PIECE CENTER PUNCH SET

Packed in a Pouch

Product Code	Description
JHWPS-4	4 Piece Center Punch Set

Contents Include:

Product Code	Description	Stock Diameter (Inches)	Product Code	Description	Stock Diameter (Inches)
JHWP-38	Center Punch	1/4	JHWP-40	Center Punch	3/8
JHWP-39	Center Punch	5/16	JHWP-42	Center Punch	1/2

Features

- Heavy duty construction for strength and durability



Made in U.S.A.



JHWPS-4

12 PIECE PILOT PUNCH SET

Packed in a Pouch

Product Code	Description
JHWPS-12	12 Piece Pilot Punch Set

Contents Include:

Product Code	Point Diameter	Product Code	Point Diameter
JHWP-51	1/16	JHWP-57	7/32
JHWP-52	5/64	JHWP-58	1/4
JHWP-53	3/32	JHWP-59	5/16
JHWP-54	1/8	JHWP-60	3/8
JHWP-55	5/32	JHWP-61	7/16
JHWP-56	3/16	JHWP-62	1/2

Features

- Designed to apply equal pressure to the end of a pin driving it straight through the hole
- The ball on the center of the point end assures proper contact with the pin eliminating damage to the pin or hole wall



Made in U.S.A.



JHWPS-12



JHWP-8

8 PIECE PILOT PUNCH SET

Packed in a Pouch

Product Code	Description
JHWP-8	8 Piece Pilot Punch Set

Contents Include:

Product Code	Point Diameter	Product Code	Point Diameter
JHWP-51	1/16	JHWP-55	5/32
JHWP-52	5/64	JHWP-56	3/16
JHWP-53	3/32	JHWP-57	7/32
JHWP-54	1/8	JHWP-58	1/4

Features

- Designed to apply equal pressure to the end of a pin driving it straight through the hole
- The ball on the center of the point end assures proper contact with the pin eliminating damage to the pin or hole wall



Made in U.S.A.

3 PIECE BRONZE DRIFT PUNCH SET

Packed in a Pouch

Product Code	Description
JHWP-3A	3 Piece Bronze Drift Punch Set

Contents Include:

Product Code	Point Diameter
JHWP-63A	3/8
JHWP-64A	1/2
JHWP-65A	3/4

Features

- For aligning unhardened steel or aluminum



Made in U.S.A.



JHWP-3A



JHW28449

PUNCH AND CHISEL HOLDER

Comfort Grip Handle

Product Code	Description
JHW28449	7/8

Features

- Holds chisel and punch securely
- Protect user from hand injury



Made in U.S.A.

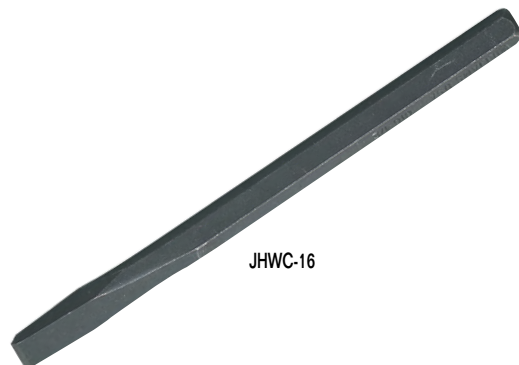

JHWC-16

COLD CHISELS

Heavy Duty Industrial Grade

Product Code	Stock Size	Blade Width (Inches)	Length (Inches)
JHWC-8	1/4	1/4	5
JHWC-10	1/4	5/16	5
JHWC-12	3/16	3/8	5 1/2
JHWC-15	3/8	7/16	6
JHWC-16	7/16	1/2	6
JHWC-20	1/2	5/8	6 1/2
JHWC-24	5/8	3/4	7
JHWC-28	3/4	7/8	7 1/2
JHWC-32	7/8	1	8
JHWC-36	7/8	1 1/8	8

Features

- The most commonly used chisels in the chisel line
- For cutting, shaping and removing metal softer than the cutting edge of the chisel



Made in U.S.A.

EXTRA-LONG COLD CHISELS

Heavy Duty Industrial Grade

Product Code	Stock Size	Blade Width (Inches)	Length (Inches)
JHWC-120	1/2	5/8	12
JHWC-124	3/8	3/4	12
JHWC-125	5/8	3/4	14
JHWC-126	5/8	3/4	18
JHWC-132	3/4	1	12
JHWC-133	3/4	1	18

Features

- Designed for cutting, shaping and removing metal softer than the cutting edge of the chisel



Made in U.S.A.

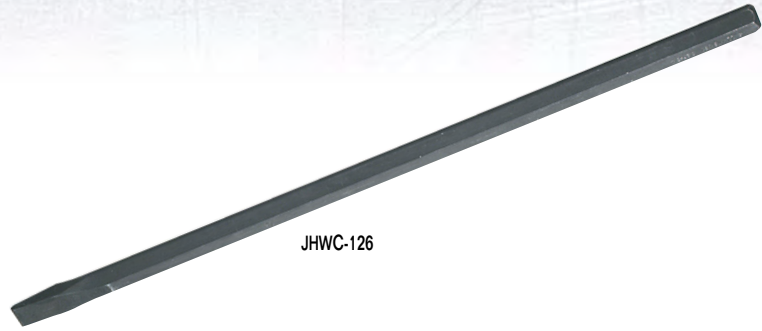

JHWC-126

RIVET-BUSTER CHISEL

Heavy Duty Industrial Grade

Product Code	Stock Size	Blade Width (Inches)	Length (Inches)
JHWC-422	5/8	3/4	12

Features

- Designed for shearing bolt heads and rivets



Made in U.S.A.



JHWC-422

CAPE CHISELS

Heavy Duty Industrial Grade

Product Code	Stock Size	Blade Width (Inches)	Length (Inches)
JHWC-40	3/8	3/16	5 5/8
JHWC-42	3/8	1/4	5 5/8
JHWC-44	1/2	5/16	6 1/4
JHWC-46	5/8	3/8	7

Features

- Designed for cutting or grooving keyholes or slots



Made in U.S.A.



JHWC-44

DIAMOND POINT CHISELS

Heavy Duty Industrial Grade

Product Code	Stock Size	Square Cut	Length (Inches)
JHWC-60	3/8	1/4	5 3/4
JHWC-62	5/8	3/8	7

Features

- Designed for making a V-groove in metal and to clean out inside corners



Made in U.S.A.



JHWC-62

ROUND NOSE CHISELS

Heavy Duty Industrial Grade

Product Code	Stock Size	Blade Width (Inches)	Length (Inches)
JHWC-72	3/8	1/4	5 3/4
JHWC-73	1/2	5/16	6 1/4
JHWC-74	5/8	3/8	7
JHWC-75	3/4	1/2	8

Features

- Designed for cutting or grooving keyholes or slots



Made in U.S.A.



JHWC-74



JHWP-57

PILOT PUNCHES

Heavy Duty Industrial Grade

Product Code	Stock Size	Point Diameter	Length (Inches)
JHWP-51	1/4	1/16	2 3/4
JHWP-52	1/4	5/64	3 1/4
JHWP-53	1/4	3/32	3 1/2
JHWP-54	1/4	1/8	4
JHWP-55	1/4	5/32	4 1/2
JHWP-56	3/8	3/16	4 1/2
JHWP-57	3/8	7/32	5
JHWP-58	7/16	1/4	5 1/2
JHWP-59	7/16	5/16	6
JHWP-60	1/2	3/8	6
JHWP-61	5/8	7/16	6
JHWP-62	5/8	1/2	6

Features

- Designed to apply equal pressure to the end of a pin driving it straight through the hole
- The ball on the center of the point end assures proper contact with the pin eliminating damage to the pin or hole wall



Made in U.S.A.



JHWP-6

PIN PUNCHES

Heavy Duty Industrial Grade

Product Code	Stock Size	Point Diameter	Length (Inches)
JHWP-3	5/16	3/32	4 1/2
JHWP-4	5/16	1/8	4 3/4
JHWP-5	3/16	3/32	5
JHWP-6	3/8	3/16	5 1/4
JHWP-8	3/8	1/4	5 3/4
JHWP-10	7/16	5/16	6

Features

- For driving out and removing already loosened pins and keys after initial movement by a solid or starter punch



Made in U.S.A.



JHWP-16

SOLID PUNCHES

Heavy Duty Industrial Grade

Product Code	Stock Size	Point Diameter	Length (Inches)
JHWP-12	3/8	1/16	5
JHWP-13	3/8	3/32	5
JHWP-14	3/8	1/8	5
JHWP-15	3/8	5/32	5
JHWP-16	3/8	3/16	5
JHWP-18	3/8	7/32	5
JHWP-17	3/8	1/4	5

Features

- For loosening frozen or tight pins and keys or knocking out rivets
- Also called starter punches because they are ideal for loosening frozen pins



Made in U.S.A.

HAMMERS, PUNCHES, CHISELS & PRYBARS

INDIVIDUAL PUNCHES

LONG TAPER PUNCHES

Heavy Duty Industrial Grade

Product Code	Stock Size	Point Diameter	Length (Inches)
JHWP-24	5/16	1/8	8
JHWP-25	3/8	5/32	9
JHWP-26	1/2	3/16	10
JHWP-28	5/8	1/4	12
JHWP-28A	3/4	1/4	15
JHWP-29	5/8	5/16	16
JHWP-27	3/4	3/8	15

Features

- Designed for aligning the holes in metal pieces through which rivets, bolts, or screws will be inserted
- Not intended for driving pins as punch may become stuck in work
- Also called line-up aligning or drift punches



Made in U.S.A.



JHWP-28

CENTER PUNCHES

Heavy Duty Industrial Grade

Product Code	Stock Size	Blade Width (Inches)
JHWP-38	1/4	4
JHWP-39	5/16	4 1/2
JHWP-40	3/8	5
JHWP-42	1/2	6

Features

- Pierces or marks work by indentation for starting pilot drills in metal or other materials



Made in U.S.A.



JHWP-40

PRICK PUNCHES

Heavy Duty Industrial Grade

Product Code	Stock Size	Length (Inches)
JHWP-30	3/8	5
JHWP-32	1/2	6

Features

- For scribing lines into metal before cutting or riveting, and for punching starting holes for short metal screws
- Point is more tapered than center punch



Made in U.S.A.



JHWP-30

BRONZE DRIFT PUNCHES

Packed in a Pouch

Product Code	Body Size	Overall Length (Inches)
JHWP-63A	3/8	6
JHWP-64A	1/2	7
JHWP-65A	3/4	8

Features

- For aligning unhardened steel or aluminum



Made in U.S.A.



JHWP-64A

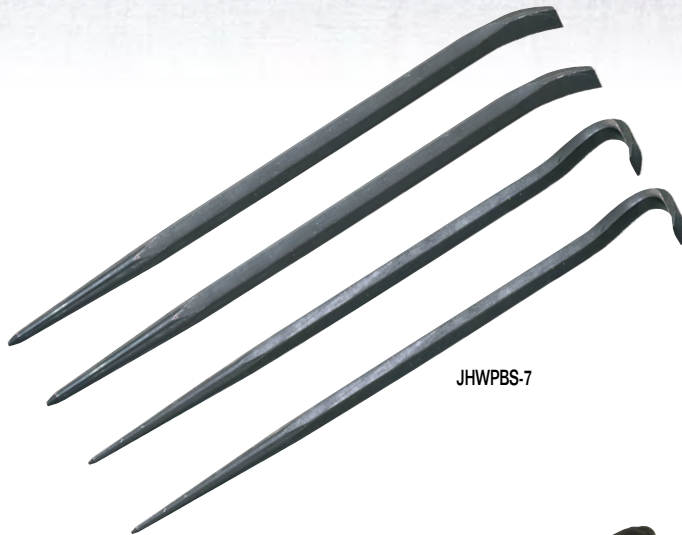

JHWPBS-7

4 PIECE PINCH & ROLL BAR SET

Heavy Duty Industrial Grade

Product Code	Description
JHWPBS-7	4 Piece Pinch & Roll Bar Set

Contents Include:

Product Code	Description	Stock Diameter (Inches)
JHWC-80A	Pinch Bar	3/4
JHWC-82A	Pinch Bar	3/4
JHWC-715	Roll Bar	1/2
JHWC-718	Roll Bar	5/8

Features

- Heavy duty construction for strength and durability



JHWC-818

JHWC-803

PRYBARS - SCREWDRIVER TYPE

Contents Include:

Product Code	Size	Overall Length (Inches)	Product Code	Size	Overall Length (Inches)
JHWC-807	3/8	12	JHWC-836	5/8	36
JHWC-812	3/8	17	JHWC-842	5/8	42
JHWC-818	1/2	25	JHWC-844	7/8	44
JHWC-824	1/2	31	JHWC-858	3/4	58

Product Code	Description
JHWC-803	3 Piece Prybar Set

Contents Include:

Product Code	Overall Length (Inches)
JHWC-807	12
JHWC-812	17
JHWC-818	25

Features

- Blade is heat-treated the entire length.
- Handle is ergonomically designed to provide a more comfortable and secure grip
- Curved blade style gives extra leverage
- Capped end allows for striking without damage to handle



LIGHTWEIGHT HANDLE PRYBARS

Single Curved Tip

Product Code	Overall Length (Inches)	Product Code	Overall Length (Inches)
JHWC-90	30	JHWC-92	41 1/2
JHWC-91	35 1/2	JHWC-93	48 1/2

Double End

Product code	Overall length (Inches)	Product code	Overall length (Inches)
JHWC-100	33	JHWC-102	44
JHWC-101	38	JHWC-103	50

Features

- Designed with drop forged hardened steel point & wedge ends
- Rust resistant black finish
- Prybar is chemically bonded to the fiberglass handle
- Half the weight of steel prybars
- Handle resists heat & cold less flex than a steel bar
- Non-Conductive fiberglass provides insulation from electrical shock
- Used by:
 - Contractors & mechanics for construction & auto repair
 - Municipalities for safe prying, lifting & digging
 - Fire & Police - Forcible entry



JHWC-90

JHWC-100

LADYFOOT PRYBARS

Product Code	Stock Size	Overall Length (Inches)
JHWC-612	1/2	12
JHWC-616	5/8	16
JHWC-621	3/4	21

Features

- Curved end ensures better leverage in small areas
- Other end for aligning work



Made in U.S.A.



PINCH BARS

Heavy Duty Industrial Grade

Product Code	Overall Length (Inches)	Stock Size	Width of Flat (Inches)
JHWC-80	14	1/2	5/8
JHWC-82	16	5/8	3/4
JHWC-82A	18	3/4	7/8
JHWC-83	20	3/4	7/8
JHWC-80A	24	3/4	7/8
JHWC-84	30	7/8	1
JHWC-85	38	3/4	7/8
JHWC-86	42	7/8	1

Features

- Used for aligning, prying and positioning



Made in U.S.A.

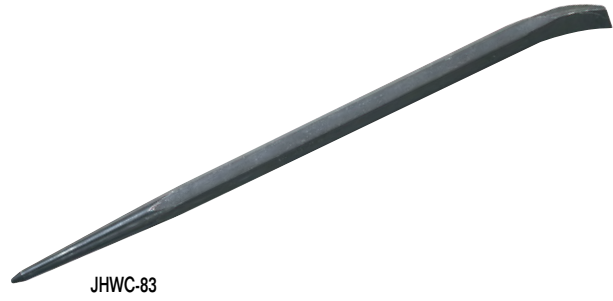

ROLL BARS

Heavy Duty Industrial Grade

Product Code	Overall Length (Inches)	Stock Size
JHWC-709	9	3/8
JHWC-715	16	1/2
JHWC-718	18	5/8

Features

- Aligning and prybar with long tapered body and 90° rolling head



Made in U.S.A.

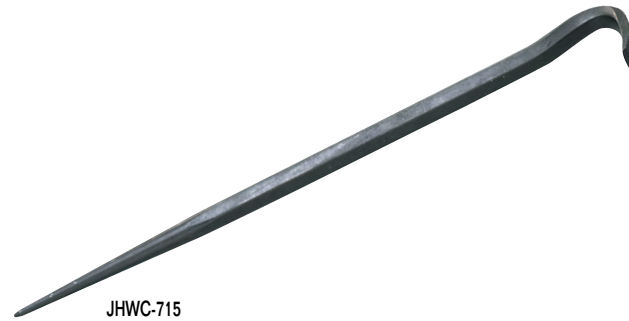

2 PIECE COMFORT GRIP PRYBAR SET

Bi-Mold Comfort Grip Handles

Product Code	Description
JHW21661	2 Piece Comfort Grip Prybar Set

Contents Include:

Size	Overall Length (Inches)
Small	8
Large	18

Features

- Bi-mold handles provide comfortable grip, reducing hand fatigue
- Thumb stop on handle provides control during use
- Fulcrum end provides extra prying power

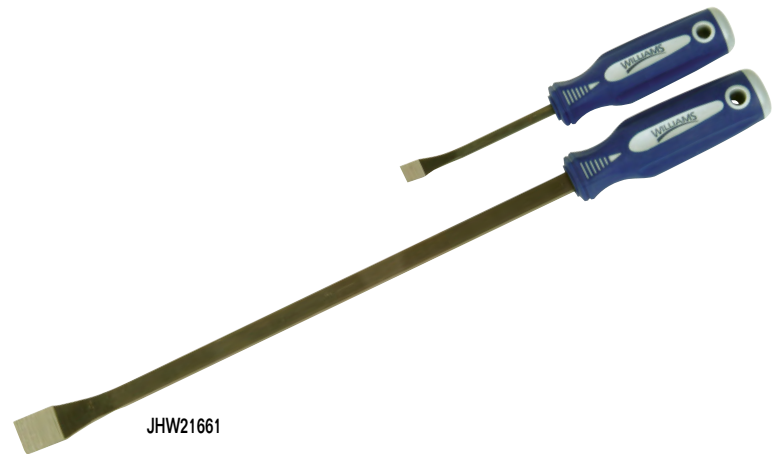

INDUSTRIAL HYDRAULICS

CYLINDERS	390
PUMPS	403
SHOP PRESS	415
JACKS	416
SPREADERS	418
MAINTENANCE KITS	419
FITTINGS	420
COUPLERS	421

LOW PROFILE MINI JACKS



SPREADERS



Large oil capacities to power a wide range of cylinders and tools

HAND PUMPS

Release valve for overload protection



Spring loaded handle lock pin

CYLINDERS

Heavy-duty, heat-treated, grooved saddle provides better surface traction during operation

Rod wiper seals out dirt and contamination

Hard, chrome-plated rod prevents scratching and corrosion

1-Piece steel rod stopper for extra strength prevents over-travel

Polyurethane cup seal provides optimum performance

Rectangular return spring design eliminates spring breakage and provides quicker retraction

Steel stop ring for rod over-travel protection

Collar fixture threads

Burnish-rolled cylinders for smoother finish than honing which reduces scoring and prolongs seal life

1-Piece high grade alloy bearing for side load protection and long life

High flow ball coupler provides more flow than conventional couplers



TOE JACKS

INDUSTRIAL HYDRAULICS

**SUPERIOR QUALITY.
MORE RELIABILITY.**

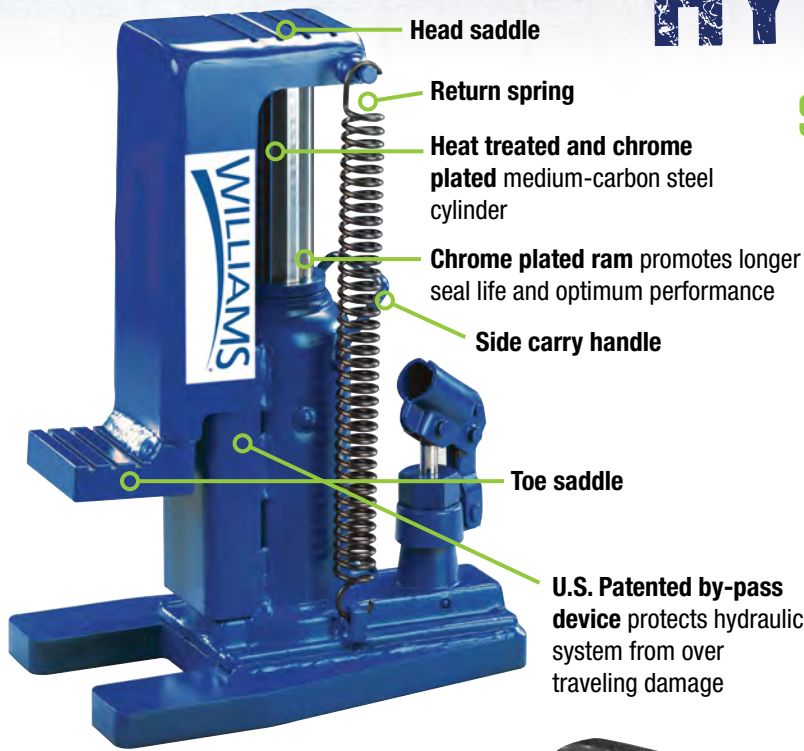

MAINTENANCE KITS

Portable for easy use in the plant or on the job site

Custom fitted, rugged, blow-molded storage case (10-ton set has wheels for easy movement)

Extension tubes

Cylinder

Hand pumps are rated from 8,000 to 10,000 PSI

Accessories

Spreader

Williams® Hydraulics are interchangeable with other manufacturers. All pumps and cylinders are marathon tested to 10,000 cycles.



SINGLE ACTING CYLINDERS

- 39 models
- Internal plunger threads
- Snap in grooved saddles
- Rod wiper seals out dirt and contamination
- Collar fixture threads
- Two base mounting holes on most models
- High strength steel construction from gun drilled solid bar
- High flow 3/8" NPTF couplers
- Collar thread protector
- One piece high grade alloy bearing for side load protection and long life
- Polyurethane cup seal provides optimum performance
- Industrial hard chrome plated ram helps prevent rust and corrosion
- Solid steel cylinder body
- Heavy duty return spring provides quicker retraction
- Ideal for lifting and pressing
- Maximum working pressure: 10,000 psi / 700 bar
- See page 421 for Cylinder accessories

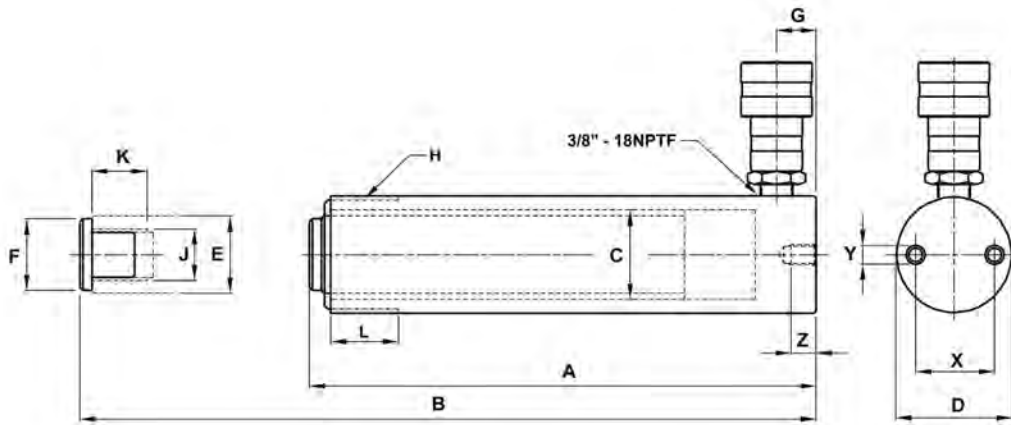

CYLINDER DIMENSIONS

Cylinder Capacity	Stroke	Product Code	Cylinder Effective Area	Pressure at Capacity	Oil Capacity	Collapsed Height	Extended Height	Cylinder Bore Dia.	Outside Dia.	Plunger Dia.	
(tons)	(in)		(in ²)	(psi)	(in ³)	A (in)	B (in)	C (in)	D (in)	E (in)	
5	0.63	JHW6C05T00	1.10	9,090	0.69	1.61	2.24	1.18	2.36 x 1.58	0.98	
	1.00	JHW6C05T01				4.58	5.58				
	3.07	JHW6C05T03				6.65	9.72				
	5.08	JHW6C05T05				8.70	59.50				
	7.09	JHW6C05T07				10.71	17.80				
	9.09	JHW6C05T09	12.72	21.81							
10	1.00	JHW6C10T01	2.24	8,930	2.24	3.62	4.62	1.69	2.26	1.49	
	2.01	JHW6C10T02				4.84	6.85				
	4.02	JHW6C10T04				6.85	10.87				
	5.94	JHW6C10T06				9.84	15.78				
	7.95	JHW6C10T08				11.85	19.80				
	9.96	JHW6C10T10				13.86	23.82				
	11.97	JHW6C10T12				15.87	27.84				
	14.02	JHW6C10T14				17.72	31.74				



JHW6C05T05

JHW6C05T07

JHW6C10T06

JHW6C10T02

INDUSTRIAL HYDRAULICS
SINGLE ACTING CYLINDERS

	Saddle Dia.	Base to Inlet Port	Collar Thread	Collar Thread Length	Plunger Internal Thread	Plunger Thread Length	Base Mounting Hole			Product Code
							Bolt Circle	Thread	Thread Depth	
	F (in)	(in)	(in)	(in)	(in)	(in)	(in)	(in)	(in)	
	N/A	0.75	N/A	N/A	N/A	N/A	1.10	0.2	N/A	JHW6C05T00
										JHW6C05T01
										JHW6C05T03
	0.98	0.79	1 ½ -16	1.10	¾"-16UNF	0.63	1.00	¼" - 20UNC	0.55	JHW6C05T05
										JHW6C05T07
										JHW6C05T09
	N/A	0.77	2 ¼ -14	1.30	#10-24UNC	0.24	1.56	5/16" - 18UNC	0.55	JHW6C10T01
										JHW6C10T02
										JHW6C10T04
										JHW6C10T06
	1.38	0.77	2 ¼ -14	1.30	1"-8UNC	0.79	1.56	5/16"-18UNC	0.55	JHW6C10T08
										JHW6C10T10
										JHW6C10T12
										JHW6C10T14

SINGLE ACTING CYLINDERS

INDUSTRIAL
HYDRAULICS

SINGLE ACTING CYLINDERS

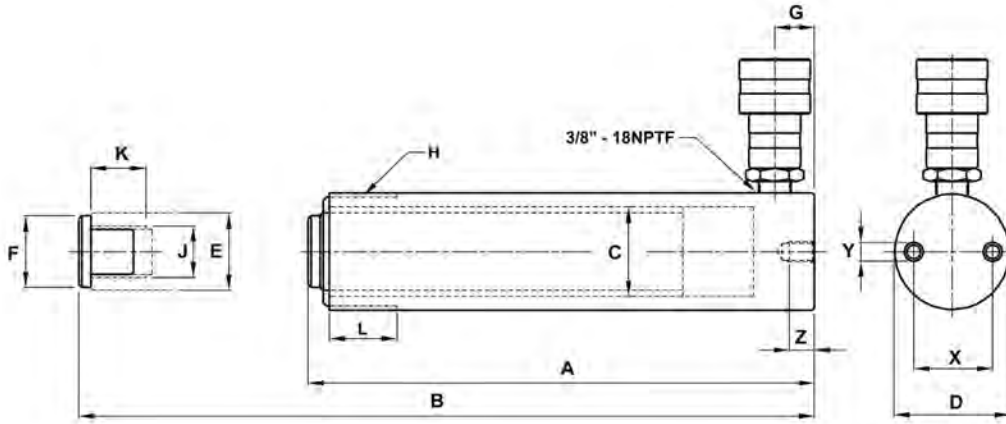

JHW6C30T08

CYLINDER DIMENSIONS

Cylinder Capacity [tons]	Stroke [in]	Product Code	Cylinder Effective Area [in ²]	Pressure at Capacity [psi]	Oil Capacity [in ³]	Collapsed Height	Extended Height	Cylinder Bore Dia. C (in)	Outside Dia. D (in)	Plunger Dia. E (in)	Saddle Dia. F (in)
						A (in)	B (in)				
15	0.99	JHW6C15T01	3.14	9,550	3.11	4.88	5.87	2.00	2.75	1.63	1.50
	2.01	JHW6C15T02			6.31	5.87	7.88				
	3.98	JHW6C15T04			12.50	7.87	11.85				
	5.87	JHW6C15T06			18.43	10.67	16.54				
	7.87	JHW6C15T08			24.71	12.68	20.55				
	9.88	JHW6C15T10			31.02	14.69	24.57				
	12.01	JHW6C15T12			37.71	16.65	28.66				
	14.02	JHW6C15T14			44.02	18.66	32.68				
25	1.02	JHW6C25T01	5.14	9,730	5.24	5.84	6.86	2.56	3.35	2.24	1.97
	2.01	JHW6C25T02			10.33	6.82	8.83				
	3.94	JHW6C25T04			20.25	8.78	12.72				
	5.94	JHW6C25T06			30.53	10.79	16.73				
	7.95	JHW6C25T08			40.86	12.80	20.75				
	9.96	JHW6C25T10			51.19	14.80	24.76				
	12.24	JHW6C25T12			62.91	16.73	28.97				
	14.25	JHW6C25T14			73.25	18.74	32.99				
30	8.27	JHW6C30T08	6.49	9,240	53.67	15.24	23.51	2.87	4.00	2.24	2.13
55	2.01	JHW6C55T02	10.99	10,000	22.09	6.93	8.94	3.74	5.00	3.15	2.76
	3.98	JHW6C55T04			43.74	8.94	12.92				
	6.22	JHW6C55T06			68.36	11.14	17.36				
	13.27	JHW6C55T13			145.84	18.15	31.42				
75	6.14	JHW6C75T06	16.10	9,320	98.85	11.22	17.36	4.53	5.79	3.74	2.76
	13.11	JHW6C75T13			211.07	19.37	32.48				
100	6.61	JHW6C100T06	20.57	9,720	135.97	14.06	20.67	5.12	6.97	4.13	2.76
	10.24	JHW6C100T10			210.64	17.68	27.92				



JHW6C15T06

JHW6C25T10

JHW6C55T06

JHW6C100T06

INDUSTRIAL
HYDRAULICS

SINGLE ACTING CYLINDERS

	Base to Inlet Port	Collar Thread	Collar Thread Length	Plunger Internal Thread	Plunger Thread Length	Base Mounting Hole			Product Code
						Bolt Circle	Thread	Thread Depth	
	G (in)	H (in)	L (in)	J (in)	K (in)	X (in)	Y (in)	Z (in)	
	0.98	2 ¼ -16	1.18	1"-8UNC	0.98	1.88	¾"-16UNC	0.51	JHW6C15T01
									JHW6C15T02
									JHW6C15T04
									JHW6C15T06
									JHW6C15T08
									JHW6C15T10
									JHW6C15T12
									JHW6C15T14
	0.98	3 ⅝ -12	1.93	1 ½ -16	1.18	2.31	½"-13UNC	0.75	JHW6C25T01
									JHW6C25T02
									JHW6C25T04
									JHW6C25T06
									JHW6C25T08
									JHW6C25T10
									JHW6C25T12
									JHW6C25T14
	1.97	3 ⅝ -12	1.93	1 ½ -16	1.18	N/A			JHW6C30T08
	1.22	5 - 12	2.17	N/A		3.75	½"-13UNC	0.75	JHW6C55T02
									JHW6C55T04
									JHW6C55T06
									JHW6C55T13
	1.18	5 ¾ - 12	1.73	N/A					JHW6C75T06
				JHW6C75T13					
	1.57	6 ⅝ - 12	1.73	N/A		5.50	¾"-10UNC	1	JHW6C100T06
									JHW6C100T10

DOUBLE ACTING CYLINDERS

- Rod wiper seals out dirt and contamination
- High strength steel construction from gun drilled solid bar
- High flow 3/8" NPTF couplers
- One piece high grade alloy bearing for side load protection and long life
- Ideal for pushing and pulling
- Maximum working pressure: 10,000 psi / 700 bar
- See page 421 for Cylinder accessories



JHW6CD55T13

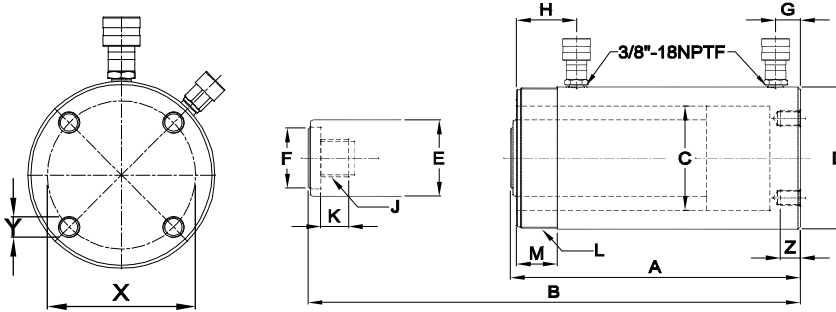

DOUBLE ACTING CYLINDER SPECIFICATIONS

Cylinder Capacity	Stroke	Product Code	Maximum Cylinder Capacity		Cylinder Effective Area		Oil Capacity		Collapsed Height	Extended Height	Cylinder Bore Dia.	Outside Dia.
			Push (ton)	Pull (ton)	Push (in ²)	Pull (in ²)	Push (in ³)	Pull (in ³)				
10	10.04	JHW6CD10T10	11.4	3.8	2.23	0.74	22.41	7.47	16.14	26.18	1.69	2.87
	11.97	JHW6CD10T12					26.71	8.90	18.03	30.00		
30	8.15	JHW6CD30T08	32.9	16.2	6.49	3.19	52.93	26.02	15.31	23.46	2.87	3.98
	14.49	JHW6CD30T15					94.09	46.26	21.65	36.14		
55	6.18	JHW6CD55T06	55.7	16.2	10.99	3.19	67.93	19.74	13.03	19.21	3.74	5.00
	13.19	JHW6CD55T13					144.94	42.11	20.04	33.23		
	20.12	JHW6CD55T20					221.09	64.24	28.86	49.98		
75	6.10	JHW6CD75T06	81.7	25.9	16.09	5.12	98.1	31.21	13.70	19.80	4.53	5.75
	13.11	JHW6CD75T13					210.93	67.06	20.71	33.82		
100	6.57	JHW6CD100T06	104.4	48.6	20.57	9.58	135.23	62.98	14.06	20.63	5.12	6.97
	13.11	JHW6CD100T13					269.66	125.58	20.63	33.74		
	18.15	JHW6CD100T18					373.31	173.86	27.05	45.20		

DOUBLE ACTING CYLINDER DIMENSIONS

Product Code	Plunger Dia.	Saddle Dia.	Base to Adv. Port	Top to Return Port	Plunger Internal Thread	Plunger Thread Length	Collar Thread	Collar Thread Length	Base Mounting Hole			Weight (lbs)			
									Bolt Circle	Thread	Thread Depth				
		E (in)	F (in)	G (in)	H (in)	J (in)	K (in)	L (in)	M (in)	X (in)	Y (in)	Z (in)			
JHW6CD10T10	1.37	1.38	1.42	2.09	1 - 8	0.98	2 ¼ - 14	1.02	N/A			26.7			
JHW6CD10T12									N/A			30.0			
JHW6CD30T08	2.13	1.97	1.65	2.91	1 ½ - 16	0.98	3 ⅝ - 12	1.93	N/A			43.0			
JHW6CD30T15									N/A			60.6			
JHW6CD55T06	3.14	2.76	1.14	2.87	1 - 12	0.98	5 - 12	1.73	N/A			70.5			
JHW6CD55T13			2.48						N/A			104.0			
JHW6CD55T20									N/A			146.2			
JHW6CD75T06	3.75	2.76	1.18	2.80	1 - 12	1.50	5 ¾ - 12	1.50	N/A			93.7			
JHW6CD75T13									N/A			136.8			
JHW6CD100T06	3.75	2.95	1.22	2.95	1 ¾ - 12	1.38	6 ⅝ - 12	1.97	5.47	¾ - 10	0.98	138.6			
JHW6CD100T13			1.50									N/A			193.6
JHW6CD100T18												N/A			248.3



JHW6CN55T12

LOCK NUT CYLINDERS

- Single acting cylinder with mechanical safety lock nut
- Designed to support load for extended periods without hydraulic pressure.
- Overflow port prevents cylinders from over travel
- Load return
- Solid steel cylinder body
- Ideal for lifting and holding loads
- Maximum working pressure:
10,000 psi / 700 bar
- See page 421 for Cylinder accessories

LOCK NUT CYLINDERS SPECIFICATIONS

Cylinder Capacity	Stroke	Product Code	Cylinder Effective Area	Oil Capacity	Collapsed Height	Extended Height	Cylinder Bore Diameter	Outside Diameter	Plunger Outside Thread
(tons)	(in)		(in ²)	(in ³)	A (in)	B (in)	C (in)	D (in)	E
55	1.97	JHW6CN55T02	10.99	21.65	6.5	8.4	3.7	4.9	Tw95-6N
	3.94	JHW6CN55T04		43.27	8.4	12.4			
	5.91	JHW6CN55T06		64.90	10.4	16.3			
	7.87	JHW6CN55T08		86.54	12.4	20.2			
	9.84	JHW6CN55T10		108.17	14.3	24.2			
	11.81	JHW6CN55T12		129.80	16.3	28.1			
100	1.97	JHW6CN100T02	20.57	40.49	7.4	9.3	5.1	6.5	Tw130-4N
	3.94	JHW6CN100T04		80.98	9.3	13.3			
	5.91	JHW6CN100T06		121.48	11.3	17.2			
	7.87	JHW6CN100T08		161.97	13.3	21.1			
	9.84	JHW6CN100T10		202.46	15.2	25.1			
	11.81	JHW6CN100T12		242.95	17.2	29.0			

LOCK NUT CYLINDERS DIMENSIONS

Product Code	Saddle Diameter	Depth of Plunger Hole	Saddle Protrusion from Plunger	Lock Nut Length	Base to Inlet Port	Weight (lbs)
	F (in)	G1 (in)	G2 (in)	H (in)	I (in)	
JHW6CN55T02	2.8	0.08	0.51	1.4	1.1	34.0
JHW6CN55T04						44.5
JHW6CN55T06						55.1
JHW6CN55T08						65.9
JHW6CN55T10						76.5
JHW6CN55T12						87.1
JHW6CN100T02				1.8		67.2
JHW6CN100T04						85.8
JHW6CN100T06						104.3
JHW6CN100T08						122.6
JHW6CN100T10						141.1
JHW6CN100T12						159.6

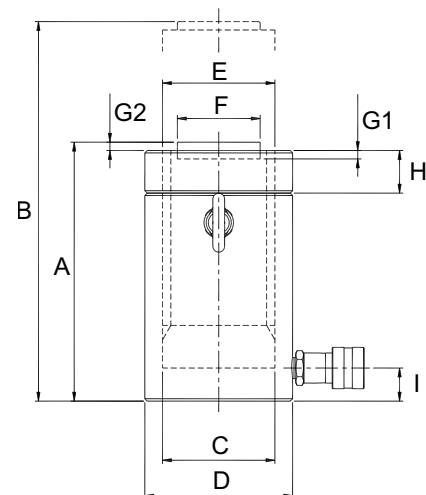

ALUMINUM CYLINDERS

- Lightweight aluminum alloy construction
- Up to 60 percent lighter than comparable tonnage steel rams
- Convenient carry handle
- Hard anodized aluminum piston rod provides extra protection against corrosion and wear
- Maximum working pressure: 10,000 psi / 700 bar
- See page 421 for Cylinder accessories

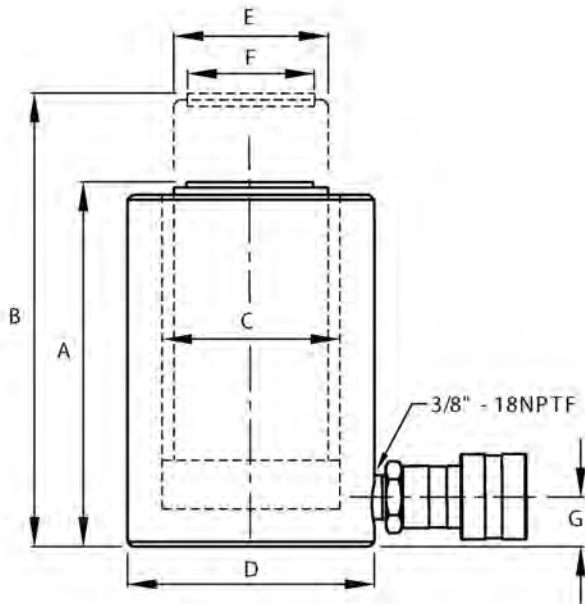

JHW6CA30T06

ALUMINUM CYLINDER DIMENSIONS

Cylinder Capacity	Stroke	Product Code	Cylinder Effective Area	Internal Pressure at Capacity	Oil Capacity	Collapsed Height	Extended Height	Cylinder Bore Dia.	Outside Dia.	Plunger Dia.	Saddle Dia.	Base to Inlet Port	Weight
(tons)	(in)		(in ²)	(psi)	(in ³)	A (in)	B (in)	C (in)	D (in)	E (in)	F (in)	G (in)	(lbs)
30	2.00	JHW6CA30T02	6.50	9,231	13.00	6.50	8.50	2.90	4.50	2.50	2.00	1.5	11.0
	4.00	JHW6CA30T04			26.00	8.50	12.50						14.0
	6.00	JHW6CA30T06			39.00	10.50	16.50						17.0
50	2.00	JHW6CA50T02	11.00	9,091	22.00	6.50	8.50	3.70	5.50	3.10	2.50		17.0
	4.00	JHW6CA50T04			44.00	8.50	12.50						21.0
	6.00	JHW6CA50T06			66.00	10.50	16.50						25.0
	10.00	JHW6CA50T10			110.00	14.50	24.50						34.0
75	4.00	JHW6CA75T04	15.00	10,000	60.00	8.50	12.50	4.40	6.50	3.90	3.00		29.0
	6.00	JHW6CA75T06			90.00	10.50	16.50						35.0
100	2.00	JHW6CA100T02	20.70	9,662	41.40	6.50	8.50	5.10	8.00	4.30	3.50		36.0
	4.00	JHW6CA100T04			82.80	8.50	12.50					43.0	
	6.00	JHW6CA100T06			124.40	10.50	16.50					51.0	
	10.00	JHW6CA100T10			207.0	14.50	24.50					68.0	

FLAT BODY CYLINDERS

- Made of high quality steel
- Extremely low collapsed height for applications with minimal clearance at the lift point
- Great for areas of low clearance
- Maximum working pressure 10,000 psi / 700 bar
- See page 421 for Cylinder accessories



JHW6CF05T03



JHW6CF10T05



JHW6CF20T05



JHW6CF30T05

FLAT BODY CYLINDER DIMENSIONS

Cylinder Mounting Hole Dimensions (in)				
Product Code	Hole Pitch	Hole Dia	Counter Bore Dia.	Counter Bore Depth
	X (in)	Y (in)	(in)	(in)
JHW6CF05T03	1.12	0.2	0.31	0.17
JHW6CF10T05	1.44	0.28	0.42	0.31
JHW6CF20T05	1.94	0.4	0.59	0.39
JHW6CF30T05	2.06	0.4	0.62	0.44
JHW6CF50T05	2.62	0.43	0.75	0.50

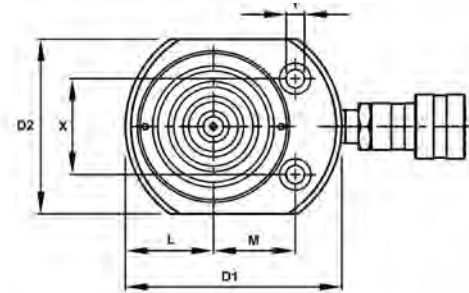
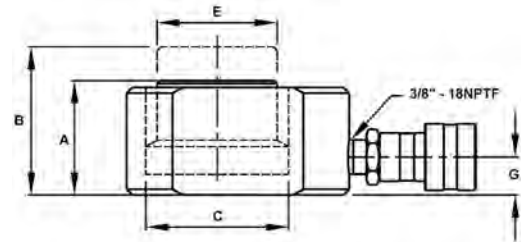

FLAT BODY CYLINDER DIMENSIONS

Cylinder Capacity	Stroke	Product Code	Cylinder Effective Area	Pressure at Capacity	Oil Capacity	Collapsed Height	Extended Height	Outside Dim.	Cylinder Bore Dia.	Plunger Dia.	Base to Port	Plunger to Base	Plunger to Mtg. Hole
								D1 x D2					
(tons)	(in)		(in ²)	(psi)	(in ³)	A (in)	B (in)	(in)	C (in)	E (in)	G (in)	L (in)	M (in)
5	0.24	JHW6CF05T03	1.10	9,090	0.26	1.26	1.5	2.4 x 1.6	1.18	0.98	0.69	0.80	0.87
10	0.43	JHW6CF10T05	2.36	8,470	1.01	1.69	2.12	3.3 x 2.2	1.73	1.50	0.77	1.12	1.32
20	0.43	JHW6CF20T05	4.38	9,130	1.88	2.01	2.44	4.0 x 3.0	2.36	2.00	0.75	1.54	1.56
30	0.51	JHW6CF30T05	6.49	9,240	3.31	2.31	2.82	4.6 x 3.8	2.87	2.50	0.79	1.88	1.75
50	.63	JHW6CF50T05	9.86	10,140	6.21	2.64	3.27	4.5 x 4.5	3.54	2.76	0.79	2.25	2.13

FLAT BODY CYLINDER KITS

- Various height magnetic adapters
- Perfect for low clearance areas needing a cylinder height boost
- Maximum working pressure: 10,000 psi / 700 bar
- Kits include magnetic adapters and carrying case
- See page 421 for Cylinder accessories

Flat Body Kit Spacers

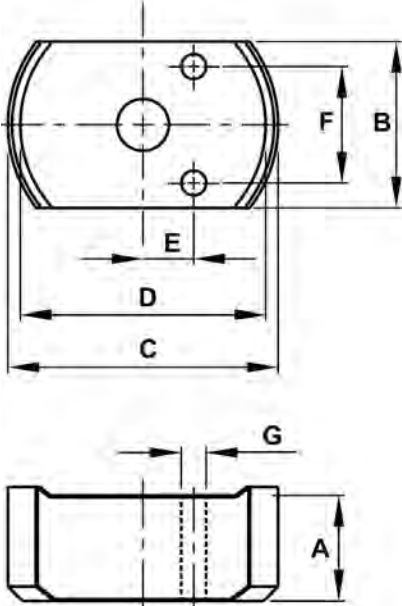

JH6CF05T03TB

FLAT BODY CYLINDER KIT DIMENSIONS

Cylinder Capacity (tons)	Stroke (in)	Product Code	Cylinder Model	Oil Capacity (in ³)	Collapsed Height (in)	Includes Adapter	Adapter Dimensions (in)						
							A	B	C	D	E	F	G
5	0.24	JH6CF05T03TB	JHW6CF05T03	0.26	1.26	I	0.25	1.61	2.56	2.32	0.48	1.10	0.24
						II	0.5						
						III	1						
						IV	1.25						
10	0.43	JH6CF10T05TB	JHW6CF10T05	1.02	1.69	I	0.39	2.20	3.54	3.23	0.81	1.46	0.28
						II	0.79				N/A		
						III	1.57						
20	0.43	JH6CF20T05TB	JHW6CF20T05	1.90	2.01	I	0.39	2.99	4.25	3.94	1.08	1.93	0.39
						II	0.79				N/A		
						III	1.57						
30	0.51	JH6CF30T05TB	JHW6CF30T05	3.32	2.31	I	0.39	3.75	4.76	4.45	1.32	2.06	0.39
						II	0.79				N/A		
						III	1.57						



JHW6CH30T06

HOLLOW HOLE CYLINDERS

- 6 standard models
- Ideal for some pulling and pushing applications
- Heavy duty compression spring
- Dual wipers help prevent contamination
- Collar thread protector
- High flow coupler with dust cap
- See page 421 for Cylinder accessories

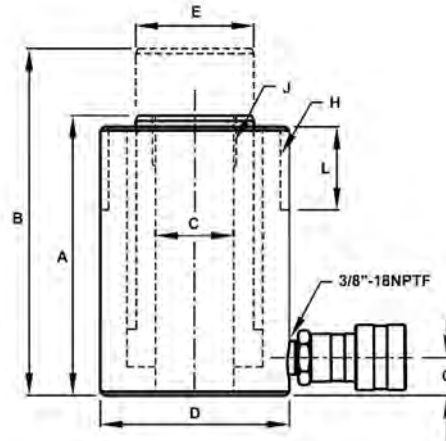

HOLLOW HOLE CYLINDER DIMENSIONS

Cylinder Capacity (tons)	Stroke (in)	Product Code	Cylinder Effective Area (in ²)	Pressure at Capacity (psi)	Oil Cap. (in ³)	Min. Height A (in)	Max. Height B (in)	O.D. D (in)	Plunger			
									I.D. C (in)	O.D. E (in)	Internal Thread J (in)	Internal Thread Length K (in)
12	3.00	JHW6CH12T03	2.91	8,236	8.72	7.24	10.24	2.760	0.770	1.38	-	-
20	2.01	JHW6CH20T02	4.90	8,167	9.83	6.38	8.39	3.92	1.063	2.15	1 1/16"-16UN	0.75
	6.06	JHW6CH20T06			29.70	12.05	18.11					
30	2.52	JHW6CH30T02	6.32	9,488	15.93	7.05	9.57	4.50	1.311	2.48	1 1/16"-16UN	0.87
	6.11	JHW6CH30T06			38.67	13.02	19.13					
60	3.00	JHW6CH60T03	13.05	9,195	39.10	9.77	12.77	6.252	2.126	3.66	2 3/4"-16UN	0.75
100	3.00	JHW6CH100T03	22.13	9,036	66.31	10.00	13.00	8.386	3.110	4.92	4"-16UN	0.98

HOLLOW HOLE CYLINDER SPECIFICATIONS

Product Code	Collar Thread		Base to Inlet Port G (in)	Base Mounting Hole			Weights (lbs)
	Dia.	Lgth.		Bolt Circle X (in)	Thread Y (in)	Thread Depth Z (in)	
	H (in)	L (in)					
JHW6CH12T03	2 3/4"-16	1.81	0.75	2.00	5/16"-18UNC	0.35	8.6
JHW6CH20T02	3 1/2"-12	1.50	0.75	3.25	3/4"-16UNC	0.37	15.9
JHW6CH20T06							29.5
JHW6CH30T02	4 1/2"-12	1.75	0.81		3/4"-16UNC	0.55	22.9
JHW6CH30T06							43.0
JHW6CH60T03	6 1/4"-12	2	1.00		1/2"-13UNC	0.55	65.7
							81.1
JHW6CH100T03	6 3/8"-12	2.38	1.06	7.01	5/8"-11UNC	0.75	113.3

PULL CYLINDERS

- High strength steel construction
- One piece high grade alloy bearing for side load protection and longer life
- Polyurethane cup seal helps provide optimum performance
- External plunger threads
- Internal base threads
- Used for pulling and tensioning
- Maximum working pressure: 10,000 psi / 700 bar
- See page 421 for Cylinder accessories

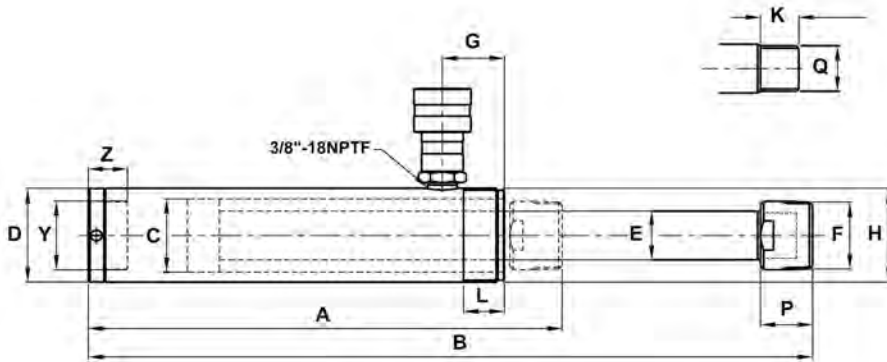

JHW6CP02T05

INDUSTRIAL
HYDRAULICS

PULL CYLINDERS

PULL CYLINDER DIMENSIONS

Cylinder Capacity (tons)	Stroke (in)	Product Code	Cylinder Effective Area (in ²)	Pressure at Capacity (psi)	Oil Capacity (in ³)	Collapsed Height A (in)	Extended Height B (in)	Outside Dia. D (in)	Cylinder Bore Dia. C (in)	Top to Inlet Port G (in)	Collar	
											Thread H (in)	Thread Length L (in)
2.5	5.00	JHW6CP02T05	0.56	8,930	2.78	10.55	15.55	1.89	1.13	1.65	1 1/2"-16	0.98
5	5.55	JHW6CP05T05	1.14	8,770	6.34	11.85	17.35	2.25	1.69	1.50	2 1/4"-14	1
10	5.95	JHW6CP10T06	2.44	8,200	14.48	11.75	17.7	3.35	2.17	1.50	M85x2	1

Product Code	Adapter		Plunger			Base Mounting Hole	
	Thread	Length	Dia.	Thread Length	Thread	Thread	Depth
	F (in)	P (in)	E (in)	K (in)	Q (mm)	H	Z (in)
JHW6CP02T05	3/4"-14NPTF	1.13	0.75	0.76	M16x1.5	3/4"-14NPTF	0.72
JHW6CP05T05	1 1/4"-11.5NPTF	1.25	1.18	0.93	M28x1.5	1 1/4"-11.5NPTF	0.95
JHW6CP10T06	-	-	1.26	1.02	M30x2	M30x2	0.98



JHW6C10T06



JHW6C10T10

THREADED HOLE CYLINDERS

- High quality threaded single acting cylinders
- Removable threaded plunger adapter allows for the use of a variety of threaded attachments
- Used to attach accessories to rod end and base
- Maximum working pressure: 10,000 psi / 700 bar
- See page 421 for Cylinder accessories

INDUSTRIAL
HYDRAULICS

THREADED HOLE CYLINDERS

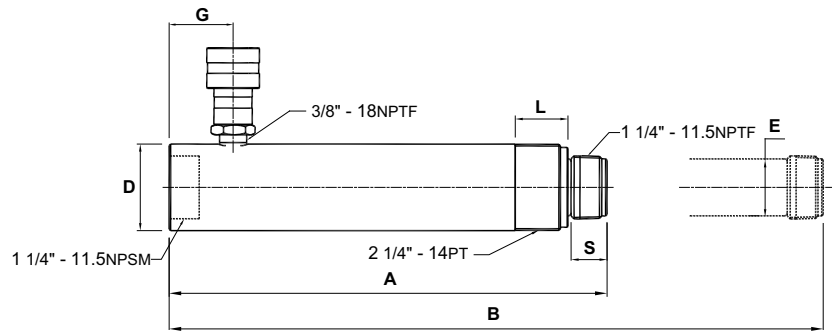

THREADED HOLE CYLINDER DIMENSIONS

Cylinder Capacity	Stroke	Product Code	Cylinder Effective Area	Pressure at Capacity	Oil Capacity	Collapsed Height	Extended Height	Outside Dia.	Plunger Dia.	Base to Inlet Port	Collar Thread Length	Saddle Height
(tons)	(in)		(in ²)	(psi)	(in ³)	A (in)	B (in)	D (in)	E (in)	G (in)	L (in)	S (in)
10	5.95	JHW6CT10T06	2.24	8,930	13.33	11.46	17.41	2.26	1.49	1.67	1.13	0.94
10	9.96	JHW6CT10T10			22.31	15.47	25.43					

LOW PROFILE CYLINDERS

- Compact design for use in confined spaces
- Rod wiper helps seal out dirt and contamination
- Specially designed return spring ensures a quick retraction and extends the life of the spring
- Industrial hard chrome plated ram helps prevent scratching and corrosion
- Plunger end is grooved to reduce load slippage
- Includes high flow ball coupler and dust cap
- Coupler is tilted upward for added clearance
- Maximum working pressure: 10,000 psi/700 bar
- See page 421 for Cylinder accessories



JHW6CL30T02



JHW6CL20T02



JHW6CL10T01

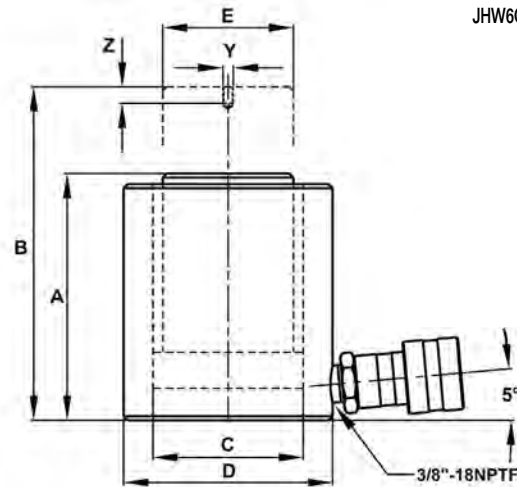
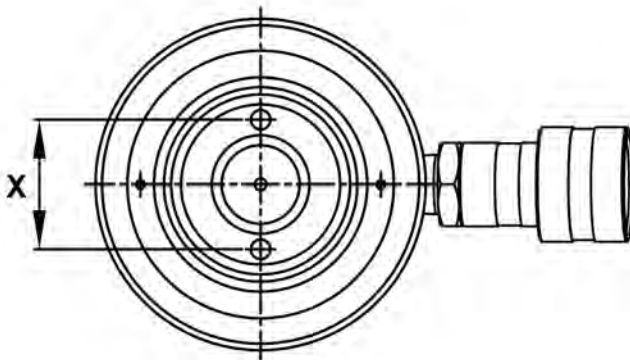

LOW PROFILE CYLINDER DIMENSIONS

Cylinder Capacity	Stroke	Product Code	Cylinder Effective Area	Internal Pressure at Capacity	Oil Capacity	Collapsed Height	Extended Height	Outside Dia.	Cylinder Bore Dia.	Plunger Dia.	Plunger Mounting		
						A	B	D	C	E	Bolt Circle X	Thread Y	Thread Depth Z
[tons]	[in]		[in ²]	[psi]	[in ³]	[in]	[in]	[in]	[in]	[in]	[in]	[mm]	[in]
10	1.50	JHW6CL10T01	2.35	8,511	3.53	3.48	4.98	2.75	1.73	1.50	1.03	M4	0.32
20	1.75	JHW6CL20T02	4.37	9,153	7.65	3.90	5.65	3.63	2.36	2.00	1.56	M4	0.32
30	2.44	JHW6CL30T02	6.49	9,245	15.84	4.61	7.05	4.00	2.87	2.50	1.56	M5	0.32
50	2.36	JHW6CL50T02	9.87	10,132	23.29	4.8	7.17	3.54	4.88	2.76	1.56	M5	0.32

HAND PUMPS

- **JHW5HS2S35, JHW5HS2S100 and JHW5HS2S200** feature 2 speed operation
- Pressure relief valve for overload protection
- Load release valve for single acting cylinder usage
- Large oil capacities to power a wide range of cylinders and tools
- **JHW5HS2S35 and JHW5HS2S100** are constructed of high strength lightweight aluminum alloy for easy handling and corrosion resistance that resists cracks and leaking
- All hand pumps function in horizontal positions and will also function in some vertical positions
- Maximum working pressure: 10,000 psi / 700 bar



JHW5HS1S60



JHW5HS2S35

JHW5HS1S60

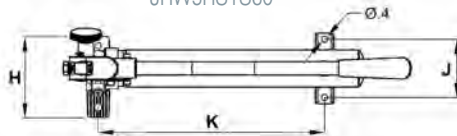

JHW5HS2S35

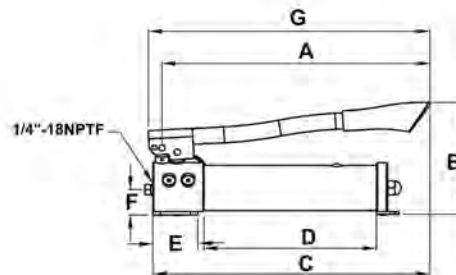
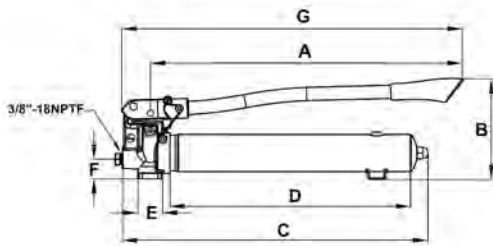

HAND PUMP SPECIFICATIONS

Used with Cylinder	Pump Type	Usable Oil Capacity (in ³)	Product Code	Pressure Rating		Oil Displacement per Stroke		Max. Operating Force (lbs)	Piston Stroke (in)	Oil Outlet Port
				(psi)		(in ³)				
				1st Stage	2nd Stage	1st Stage	2nd Stage			
Single Acting	Single-speed	36.5	JHW5HS1S60	200	10,000	0.15	0.13	109	0.79	3/8"-18NPTF
		67.0	JHW5HS1S120					89	0.82	3/8"-18NPTF
	Two-speed	21.4	JHW5HS2S35	0.18	0.05	88	0.38	1/4"-18NPTF		
		61.0	JHW5HS2S100	0.81	0.14	132	0.82	3/8"-18NPTF		
		128.0	JHW5HS2S200							

INDUSTRIAL HYDRAULICS
HAND PUMPS

HAND PUMPS



JHW5HS2S100



JHW5HS2S200

INDUSTRIAL
HYDRAULICS

HAND PUMPS

JHW5HS2S100

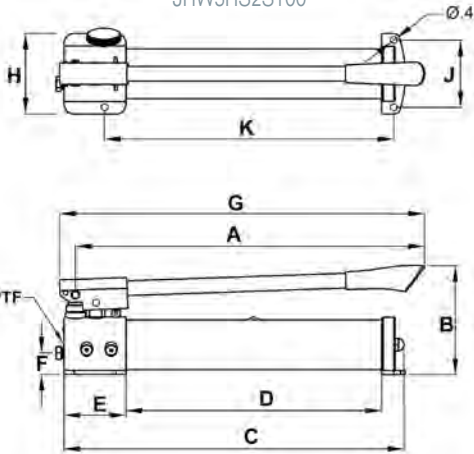

JHW5HS2S200

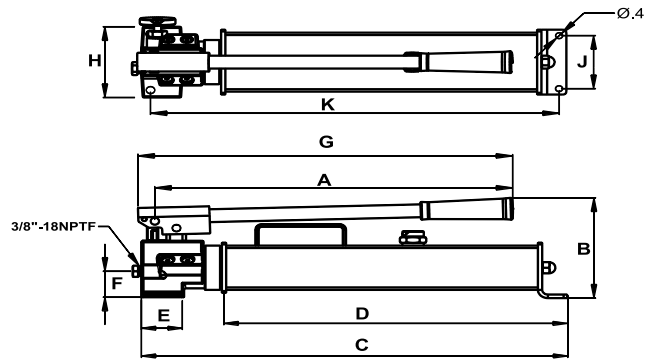

HAND PUMP DIMENSIONS

Product Code	Dimensions (in)									
	A	B	C	D	E	F	G	H	J	K
JHW5HS1S60	18.94	6.46	19.53	15.35	1.57	1.26	20.79	5.20	3.74	14.45
JHW5HS1S120	20.50	6.50	21.75	17.50	2.13	1.75	22.63	5.25	3.74	21.25
JHW5HS2S35	13.43	5.91	13.89	9.09	2.36	1.34	14.13	3.35	2.56	-
JHW5HS2S100	19.69	6.38	19.88	14.96	3.62	1.26	20.63	4.72	3.94	16.93
JHW5HS2S200	19.75	6.64	23.69	18.37	2.36	1.73	20.71	4.72	3.54	22.56

DOUBLE ACTING HAND PUMPS

- A 4-way control valve for operation of double acting cylinders
- Large oil capacities to power a wide range of cylinders and tools
- Two speed operation increases productivity and reduces user fatigue
- Metal reservoirs are made of steel or aluminum alloy and resists cracks and leaking



JHW5HD2S500

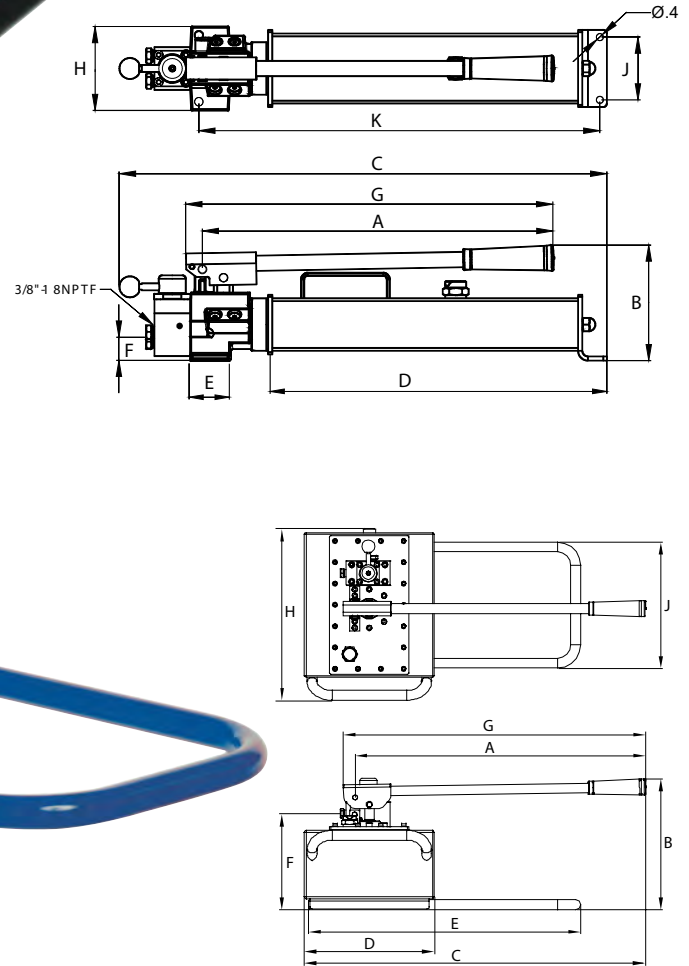

INDUSTRIAL
HYDRAULICS

DOUBLE ACTING HAND PUMPS

DOUBLE ACTING HAND PUMP SPECIFICATIONS

Used with Cylinder	Pump Type	Usable Oil Capacity	Product Code	Pressure Rating		Oil Displacement per Stroke		Max. Operating Force (lbs)	Piston Stroke (in)	Oil Outlet Port	Weight (lbs)
				1st Stage (psi)	2nd Stage (psi)	1st Stage (in ³)	2nd Stage (in ³)				
Double Acting	Two Speed	128.0	JHW5HD2S100	200	10,000	0.81	0.14	132	0.82	3.8"-18NPTF	32.2
		476.0	JHW5HD2S500	290		7.31	0.29	143	1.67		77.4

DOUBLE ACTING HAND PUMP DIMENSIONS

Product Code	Dimensions (in)									
	A	B	C	D	E	F	G	H	J	K
JHW5HD2S100	19.75	6.64	23.69	18.37	2.36	1.73	20.71	4.72	3.54	22.56
JHW5HD2S500	25.79	11.61	30.35	11.54	24.17	8.25	26.94	15.24	11.18	-

AIR PUMPS

- High strength reinforced aluminum alloy reservoir is lightweight and corrosion resistant that resists cracks and leaking
- Pressure relief valve for overload protection
- Suggested air pressure range: 90-175 psi / 6-12 bar
- Designed to be used with single acting cylinders
- Dust cover protection for the release control valve
- Dual stage release control valve
- 5AS200 offers a turbo function that features high flow at high pressure condition
- 5AD150M offers a 4-way control valve for operation of double acting cylinders
- Maximum working pressure: 10,000 psi / 700 bar

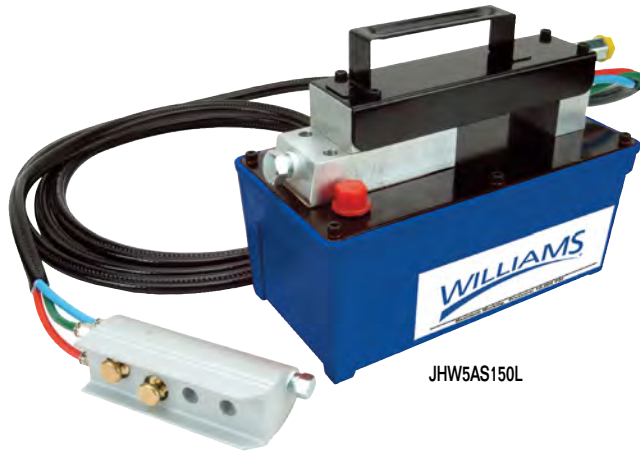

INDUSTRIAL
HYDRAULICS

AIR PUMPS

AIR PUMP SPECIFICATIONS

Used with Cylinder	Usable Oil Capacity (in ³)	Product Code	Pressure Rating (psi)	Oil Output Flow Rate (in ³ /min)		Input Air Pressure Range (psi)	Dimensions (in)				
				No Load	Load		A	B	C	D	E
Single Acting	36.6	JHW5AS60	10,000	61	9	100-200	16.54	9.84	7.01	6.18	5.59
	91.5	JHW5AS150		66	11		10.35	5.00	7.28	5.16	5.35
	122.1	JHW5AS200		65	12		11.57	6.02	7.91	6.18	5.98
	231.9	JHW5AS380		65	11		12.64	5.08	7.36	5.24	7.36
	91.5	JHW5AS150L		61	10		10.98	6.30	8.03	5.12	5.35
	231.9	JHW5AS380L		61	10		12.64	6.42	8.15	5.20	7.36
Double Acting	91.5	JHW5AD150M	10,000	66	11	100-200	10.35	5.00	7.99	5.35	5.35

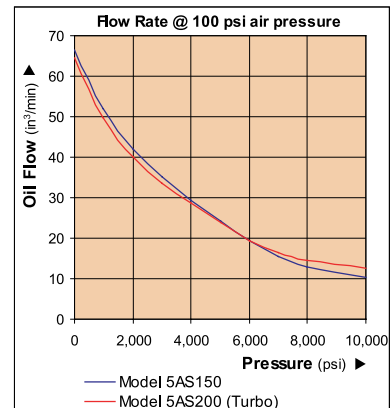
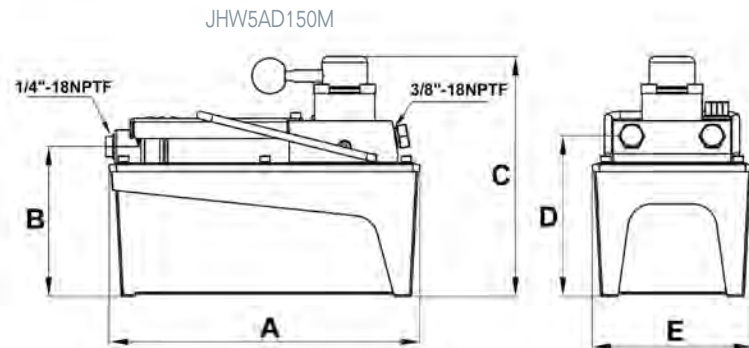



JHW5AS60



JHW5AS150



JHW5AS380L

**INDUSTRIAL
HYDRAULICS
AIR PUMPS**

JHW5AS60

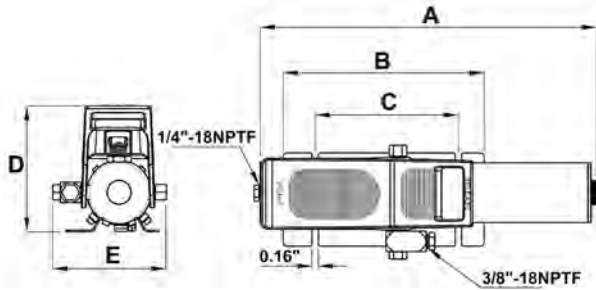

JHW5AS150L & JHW5AS380L

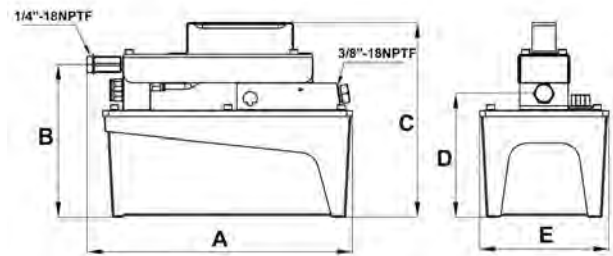

JHW5AS150 & JHW5AS380

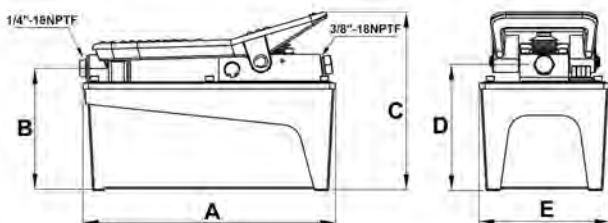

JHW5AS200

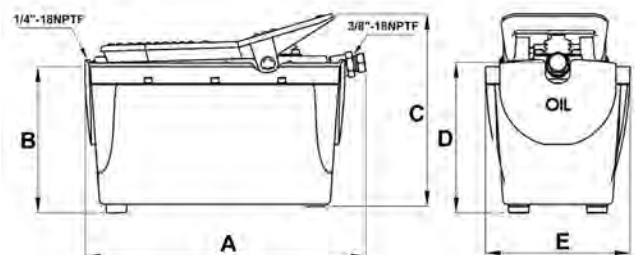

ELECTRIC PUMPS

- Quiet operation meets OSHA regulations (80dBA)
- 2 speed operation allows for faster cylinder advance
- Full load starting capacities
- Internal filter keeps contamination from damaging pump
- Rugged durable design meets the demands of industrial applications
- Precision components to minimize wear and improve overall dependability
- Designed to minimize the number of moving parts and maximize overall pump efficiency
- Ideal for on site construction as well as maintenance
- Metal reservoirs are made of steel or aluminum alloy and resists cracks and leaking

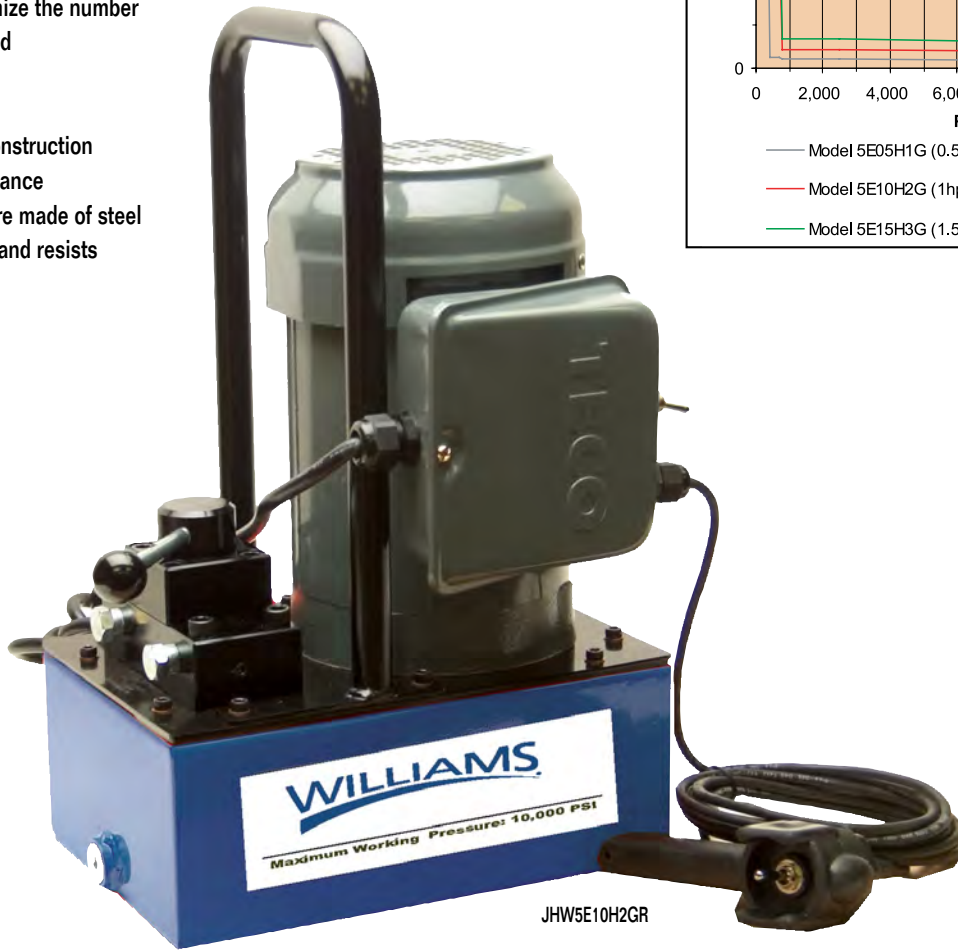
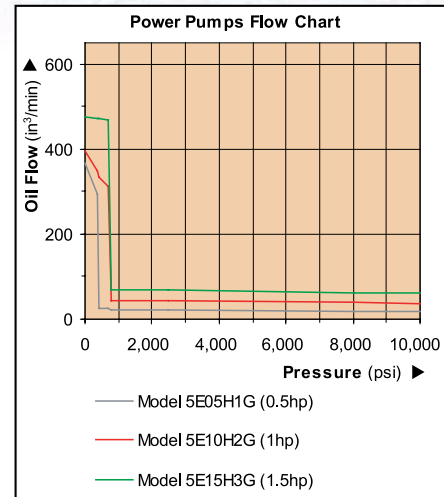

JHW5E10H2GR

JHW5E05H1G

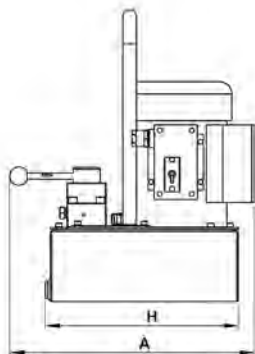
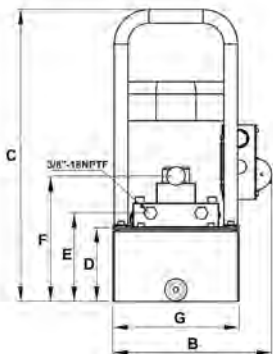

JHW5E10H2G & JHW5E15H3G

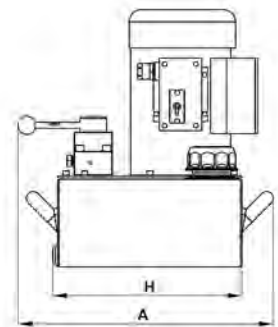
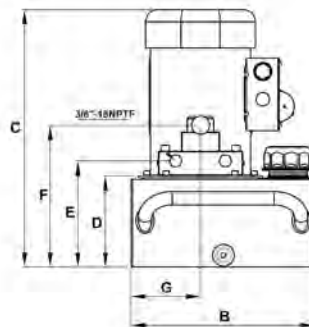



JHW5E05H1G



JHW5E10H2G

INDUSTRIAL
HYDRAULICS

ELECTRIC PUMPS

ELECTRIC PUMP DIMENSIONS

Product Code	Dimensions (in)							
	A	B	C	D	E	F	G	H
JHW5E05H1G	15.43	10.28	19.09	4.72	5.67	7.99	8.07	12.36
JHW5E10H2G	16.65	12.01	17.83	5.94	6.89	9.21	4.53	12.36
JHW5E15H3G	16.65	12.01	19.72	7.24	8.19	10.51	4.53	12.36

ELECTRIC PUMP SPECIFICATIONS

Motor Size (hp)	Usable Oil Capacity (gal)	Product Code	Product Code with Remote Control Pendant Switch	Max. Output Pressure (psi)	Oil Output Flow Rate (in ³)		Valve Type	Valve Function	Current Draw (amps)	Motor Voltage (volts)	Sound Level (dBA)
					1st Stage	2nd Stage					
0.5	1.0	JHW5E05H1G	JHW5E05H1GR	10,000	293	18	4-way, 3-pos.	Advance Hold Return	8	115	80
1.0	2.0	JHW5E10H2G	JHW5E10H2GR		311	37			15		
1.5	3.0	JHW5E15H3G	JHW5E15H3GR		470	61			17		

ELECTRIC PUMPS WITH SOLENOID VALVE

- Quiet operation meets OSHA regulations (80dBA)
- Ideal for applications where a remote control is required
- 2 speed operations allows for faster cylinder advance
- Full load starting capabilities
- Internal filter keeps contamination from damaging pump
- 10 foot hand held remote controls the solenoid valve
- Metal reservoirs are made of steel or aluminum alloy and resists cracks and leaking

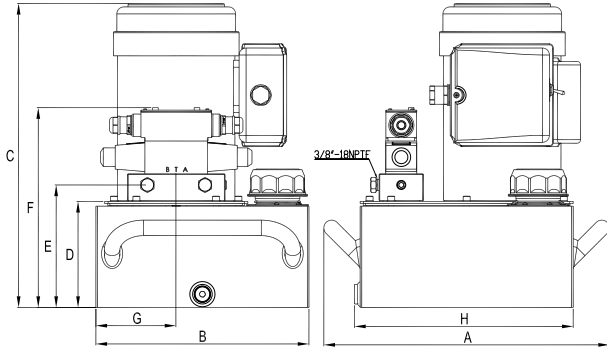

INDUSTRIAL HYDRAULICS

ELECTRIC PUMPS WITH SOLENOID VALVE

ELECTRIC PUMP WITH SOLENOID VALVE SPECIFICATIONS

Used with Cylinder	Motor Size	Usable Oil Capacity (gal)	Product Code	Pressure Rating		Oil Output Flow Rate		Valve Type	Valve Function	Current Draw (amps)	Motor Voltage (volts)	Weight (lbs)					
	(hp)			1st Stage (psi)	2nd Stage (psi)	1st Stage (in ³ /min)	2nd Stage (in ³ /min)										
Single Acting	0.5	1	JHW5ES05H1G	350	10,000	293	18	3-way, 3-position	Advance/ Hold/ Return	9	115	61.5					
		2	JHW5ES05H2G									65.3					
	1	2	JHW5ES10H2G	700		311	37					12	72.6				
		3	JHW5ES15H3G	700		470	61					17	90.4				
			5										JHW5ES15H5G	98			
Double Acting	0.5	1	JHW5ES05H1GR	350	10,000	293	18	4-way, 3-position	Advance/ Hold/ Return	9	115	61.5					
		2	JHW5ES05H2GR									65.3					
	1	2	JHW5ES10H2GR	700		311	37					12	72.6				
		3	JHW5ES15H3GR										700	470	61	17	72.6
			5														JHW5ES15H5GR

ELECTRIC PUMP WITH SOLENOID VALVE DIMENSIONS

Product Code	Dimensions (in)							
	A	B	C	D	E	F	G	H
JHW5ES05H1G	12.74	10.26	19.10	4.72	5.65	10.00	8.07	12.32
JHW5ES05H2G	12.74	10.26	19.10	4.72	5.65	10.00	8.07	12.32
JHW5ES10H2G	17.88	12.01	17.88	5.98	6.90	11.26	4.51	12.32
JHW5ES15H3G	17.88	12.01	17.88	5.98	6.90	11.26	4.51	12.32
JHW5ES15H5G	16.10	12.01	17.13	5.98	6.90	11.26	4.51	12.32
JHW5ES05H1GR	16.10	12.01	17.13	5.98	6.90	11.26	4.51	12.32
JHW5ES05H2GR	16.10	12.01	19.78	7.28	8.20	12.56	4.51	12.32
JHW5ES10H2GR	16.10	12.01	19.78	7.28	8.20	12.56	4.51	12.32
JHW5ES15H3GR	16.10	12.01	24.78	12.28	13.20	17.56	4.51	12.32
JHW5ES15H5GR	16.10	12.01	24.78	12.28	13.20	17.56	4.51	12.32

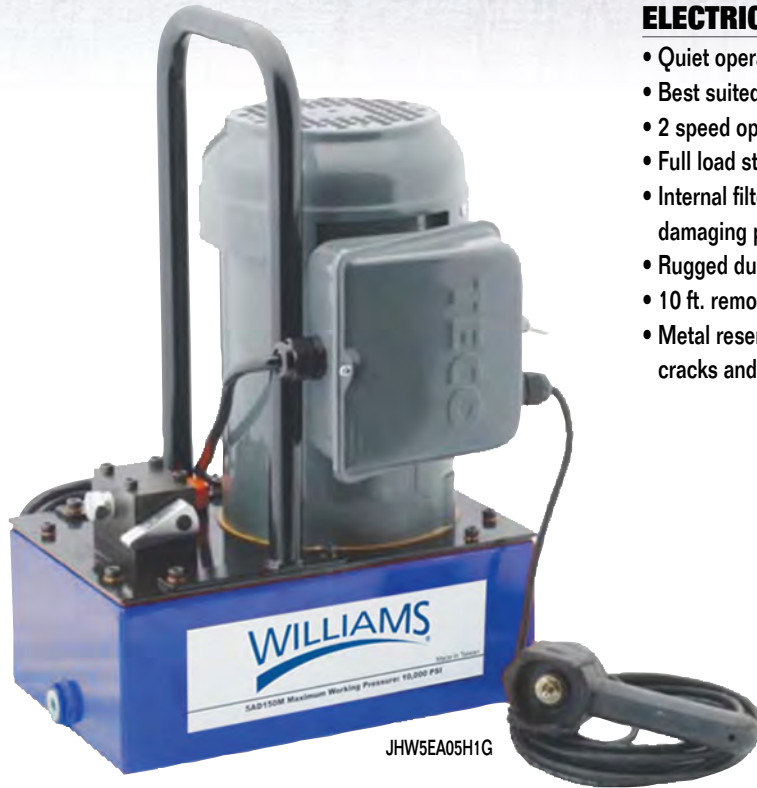

ELECTRIC PUMP WITH AUTO RETURN VALVE

- Quiet operation meets OSHA regulations (80dBA)
- Best suited for punching, crimping and cutting applications
- 2 speed operation allows for faster cylinder advance
- Full load starting capabilities
- Internal filter keeps contamination from damaging pump
- Rugged durable design meets the demands of industrial applications
- 10 ft. remote pendant switch to control motor on/off
- Metal reservoirs are made of steel or aluminum alloy and resists cracks and leaking

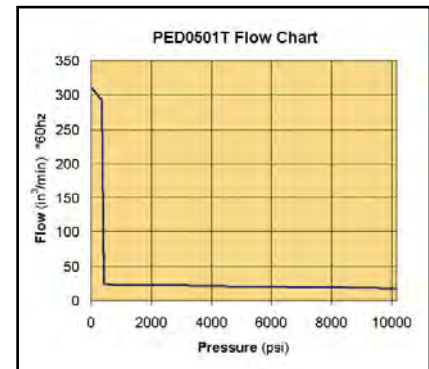
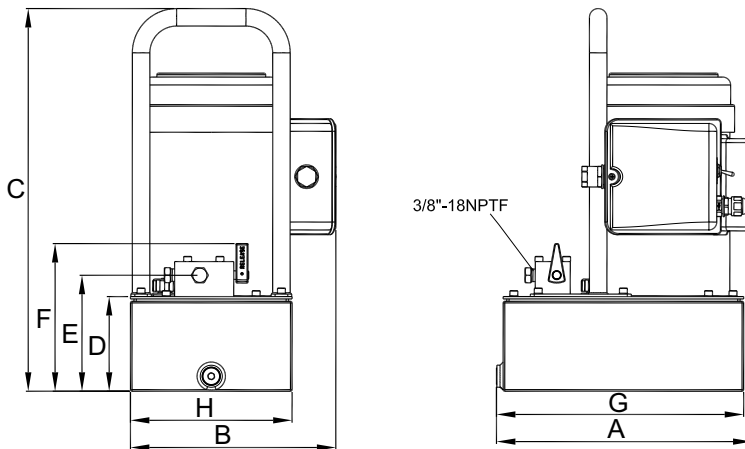

ELECTRIC PUMP WITH AUTO RETURN VALVE SPECIFICATIONS

Motor Size [hp]	Usable Oil Capacity [gal]	Product Code	Pressure Rating		Oil Output Flow Rate		Valve Type	Valve Function	Current Draw [amps]	Motor Voltage [volts]	Sound Level [dBA]	Weight [lbs]
			1st Stage [psi]	2nd Stage [psi]	1st Stage [in ³ /min]	2nd Stage [in ³ /min]						
0.5	1.0	JHW5EA05H1G	350	10,000	233	18	2-way, 2-position	*Advance/ Return	9	115	80	66.2

* Holds pressure in advance position when motor is off.

ELECTRIC PUMP WITH AUTO RETURN VALVE DIMENSIONS

Product Code	Dimensions (in)						
	A	B	C	D	E	F	G
JHW5EA05H1G	12.76	10.28	19.09	4.72	5.79	7.36	12.36

ELECTRIC PUMPS WITH PENDANT SWITCH

- Quiet operation meets OSHA regulations (80dBA)
- 2 speed operation allows for faster cylinder advance
- Full load starting capacities
- Internal filter keeps contamination from damaging pump
- 10 foot hand held remote control allows user to control cylinder in up or down position
- Metal reservoirs are made of steel or aluminum alloy and resists cracks and leaking

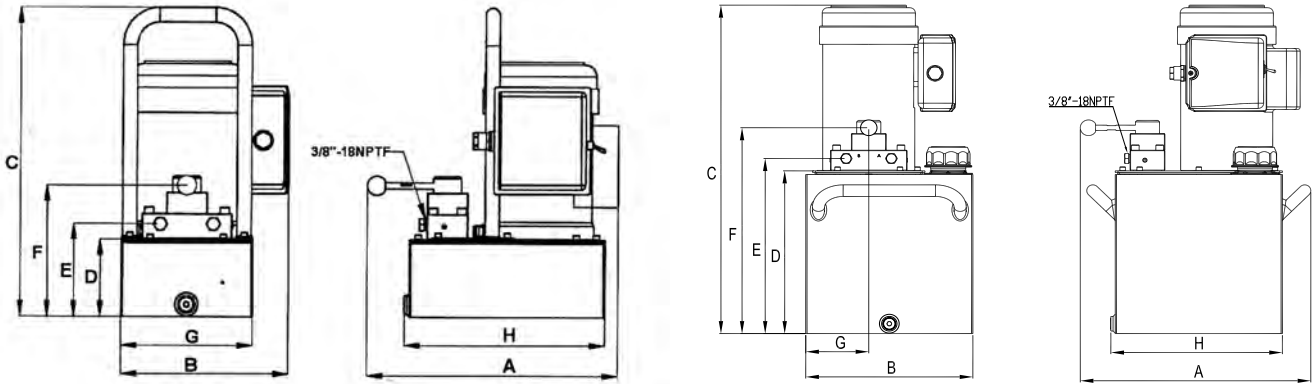

ELECTRIC PUMP WITH SOLENOID VALVE SPECIFICATIONS

Used with Cylinder	Motor Size	Usable Oil Capacity	Product Code	Pressure Rating		Oil Output Flow Rate		Valve Type	Valve Function	Current Draw (amps)	Motor Voltage (volts)	Weight (lbs)
	(hp)	(gal)		1st Stage (psi)	2nd Stage (psi)	1st Stage (in ³ /min)	2nd Stage (in ³ /min)					
Single Acting	0.5	1.0	JHW5E05H1GR	350	10,000	293	18	3-way, 3-position	Advance/ Hold/ Return	9	115	59.5
	1.0	2.0	JHW5E10H2GR	700		397	37			12		70.5
	1.5	3.0	JHW5E15H3GR	700		476	61			17		88.5

ELECTRIC PUMP WITH SOLENOID VALVE DIMENSIONS

Product Code	Dimensions (in)							
	A	B	C	D	E	F	G	H
JHW5E05H1GR	14.92	10.28	19.10	4.72	5.67	7.99	8.07	12.36
JHW5E10H2GR	16.65	12.01	17.83	5.94	6.89	9.21	4.53	12.36
JHW5E15H3GR	16.65	12.01	19.72	7.24	8.19	10.51	4.53	12.36



JHW5G102H5G

GAS ENGINE PUMP

- Gas pump will provide 10,000 psi hydraulic force at remote locations
- Industrial grade 5.5 hp Honda gas engine
- Manual control valve for use with single or double acting cylinders or tools
- Two speed pump designed for rapid cylinder advance
- Gas pump features a sturdy protective roll cage for use in the toughest environments
- Metal reservoirs are made of steel or aluminum alloy and resists cracks and leaking



JHW5D73H10G





DIESEL ENGINE PUMP

- Diesel engine pumps will provide 10,000 psi at remote locations
- Industrial grade 5.5 hp Honda gas engine
- Locking solenoid control valve for use with single or double acting cylinders or tools
- Two speed pump designed for rapid cylinder advance
- Ideal for application when diesel fuel in remote environments is required
- Comes standard with electric start
- Metal reservoirs are made of steel or aluminum alloy and resists cracks and leaking

ENGINE PUMP SPECIFICATIONS

Motor Size [hp]	Usable Oil Capacity [gal]	Product Code	Pressure Rating		Oil Output Flow Rate		Valve Type	Valve Function	Rotation Speed	Sound Level
			[psi]		[in ³]					
			1st Stage	2nd Stage	1st Stage	2nd Stage			[rpm]	[dBA]
10.2	10.0	JHW5G102H5G [Gas]	700	10,000	600	200	4-way 3-position	Advance/Hold/Return	3600	93
7.3	10.0	JHW5D73H10G [Diesel]	700	10,000	600	200	4-way 3-position	Advance/Hold/Return	3600	93





AIR & HAND PUMPS AND SINGLE-ACTING CYLINDER MATCHING CHART

Capacity (Tons) ▶ Stroke (Inches) ▼	5	10	15	25	30	55	75	100
<1.00								
1.00								
2.00								
3.00								
4.00								
5.00								
6.00								
7.00								
8.00								
9.00								
10.00								
12.00								
13.00								
14.00								
   	JHW5AS60		JHW5AS150			JHW5AS380		

Note: Selection based on oil capacity requirements of cylinders.

 Not Recommended

HAND PUMP / E-PUMP AND SINGLE-ACTING CYLINDER MATCHING CHART

Capacity (Tons) ▶ Stroke (Inches) ▼	5	10	15	25	30	55	75	100
<1.00								
1.00								
2.00								
3.00								
4.00								
5.00								
6.00								
7.00								
8.00								
9.00								
10.00								
12.00								
13.00								
14.00								
    	JHW5HS2S35	JHW5HS2S100		JHW5HS2S200		JHW5E10H2G		

Note: Selection based on oil capacity requirements of cylinders.



55/100 TON SHOP PRESS

- Heavy steel welded construction
- Multi-position bed for work height adjustment
- Ideal for the removal or installation of gears, universal joints, pulleys, wrist pins, and other press jobs
- Excellent for bending, bonding or straightening applications
- Pump, cylinder, hose and fittings are included



All press frames are made in the USA and meet ISO 9001/2008 and CDI certification.

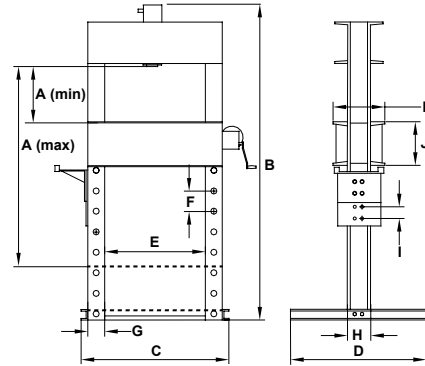

55/100 TON SHOP PRESS SPECIFICATIONS

Product Code	Capacity (Tons)	Pump Model	Pump Type	Stroke Length	Bed Position	Product Size (H X L X W)	Working Space (A Min. / A Max.) (in)	Weight (lbs)
JHW9A55T06	55	JHW5AS150	AIR	6	9	79" X 56" X 30"	14" ~ 55-1/2"	760
JHW9E55T06		JHW5E05H1GR	ELECTRIC	6				
JHW9H55T06		JHW5HS25200	MANUAL	6				
JHW9A55T13		JHW5AS380	AIR	13				
JHW9E55T13		JHW5E05H1GR	ELECTRIC	13				
JHW9E100T10	100	JHW5E10H2GR	ELECTRIC	10	8	89" X 63" X 30"	11-1/4" ~ 51"	1550

55/100 TON SHOP PRESS DIMENSIONS

Product Code	Dimensions (in)											
	A (Min.)	A (Max.)	B	C	D	E	F	G	H	I	J	K
JHW9A55T06	14	55.5	79	56	30	35.4	6	4	9	3	10	14.8
JHW9E55T06												
JHW9H55T06												
JHW9A55T13												
JHW9E55T13												
JHW9E100T10	11.3	51	89	63	30	35.5	8	N/A	10	N/A	12	16

SHOP PRESS ACCESSORIES



55 Ton Press Accessory Kit S/A

Product Code
JHW55TKSA

Contents Include:
 (1) Ram forcing cap
 (1) Threaded adapter
 (1) 1-1/2" push adapter
 (1) 1-1/4" push adapter
 (1) V push adapter
 (1 pair) 55T Arbor plates



55 Ton & 100 Ton Shop Press Guard

Product Code
JHW55100SPG



V-Blocks 100 Ton - Pair

Product Code
JHW100TAP

V-Blocks 55 Ton - Pair

Product Code
JHW55TAP

MINI JACKS

- Low profile mini jack
- Compact and lightweight
- Convenient for storage
- Interchangeable saddle on model JHW3M05T75 and JHW3M05T150

INDUSTRIAL
HYDRAULICS

MINI JACKS



JHW3M05T75



JHW3M05T150



JHW3M10T160

MINI JACK DIMENSIONS

Capacity	Product Code	Minimum Height	Maximum Height	Hydraulic Lifting	Base Size (L x W)	Weight
(tons)		(in)	(in)	(in)	(in)	(lbs)
5	JHW3M05T75	2.37	3.13	0.76	4.13 x 4.00	4.6
	JHW3M05T150	3.37	4.88	1.51	4.13 x 4.00	5.3
10	JHW3M10T160	4.75	6.25	1.63	4.88 x 4.38	12.5
20	JHW3M20T160	5.13	6.75	1.63	5.38 x 4.75	16.7



JHW4T06T



JHW4T10T

TOE JACKS

- Heat treated and chrome plated medium-carbon steel cylinder
- Chrome plated ram promotes longer seal life and optimum performance
- U.S. Patented by-pass device protects hydraulic system from over traveling damage

TOE JACK DIMENSIONS

Capacity (tons)	Product Code	Toe Saddle		Head Saddle		Hydraulic Lifting (in)
		Min. Height (in)	Max. Height (in)	Min. Height (in)	Max. Height (in)	
6	JHW4T06T	0.88	6.00	10.50	15.63	5.13
10	JHW4T10T	1.13	6.25	11.00	16.13	



JHW3S20TV

SIDE PUMP BOTTLE JACK

- Hydraulic system is protected from internal damage by a patented by-pass mechanism
- Machined and polished cylinders with die-cut threads provide non-abrasive leak-free, durable performance
- Fabricated from hard-cast steel with heat-treated critical stress areas
- Serrated heat-treated saddle provides generous lifting area and secure grip
- Heat-treated extension screw allows low pick-up height adjustment and maximum lift height
- U.S. patented built-in by-pass device protects hydraulic system from overpumping damage
- Unique cross-type forged release valve assures positive control
- A wide, rugged base provides stability and strength
- Critical stress points are reinforced in all models for added durability and dependability
- Economically priced for maximum value

SIDE PUMP BOTTLE JACK DIMENSIONS

Capacity (tons)	Product Code	Min. Height	Max. Height	Extension Screw (in)	Hydraulic Lifting (in)	Base Size (L x W) (in)
		(in)	(in)			
12	JHW3T12TV	9.50	18.63	3.13	6.00	5.25 x 5.13
	JHW3S12TV	6.00	10.63	1.63	3.00	
20	JHW3T20TV	9.50	18.63	3.13	6.00	6.25 x 5.88
	JHW3S20TV	6.50	11.25	1.63	3.13	

SPREADERS



JHW6S.5T03

JHW6S.5T03

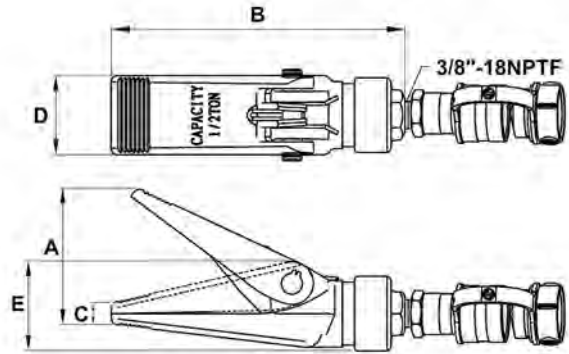

JHW6S01T03

JHW6S01T03

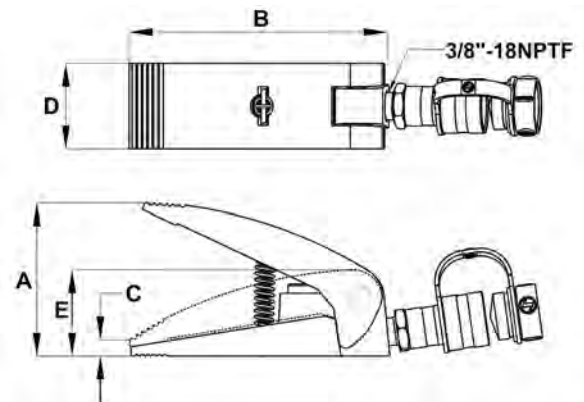

SPREADER DIMENSIONS

Cylinder Capacity (tons)	Product Code	Cylinder Effective Area (in ²)	Oil Capacity (in ³)	Dimensions (in)				
				A	B	C	D	E
0.5	JHW6S.5T03	1.22	0.58	3.54	7.57	0.51	2.05	2.36
1	JHW6S01T03	1.09	0.86	3.90	6.57	0.47	2.17	2.20



JHW4M10T

MAINTENANCE KITS

- Sets are portable for easy use in the plant or on the job site
- Custom fitted, rugged blow molded storage case
- 10 ton set has wheels for easy movement
- Designed for applications of pushing, spreading, pressing and more
- Pumps are rated from 8,000 to 10,000 psi

INDUSTRIAL
HYDRAULICS

MAINTENANCE KITS

MAINTENANCE KITS

Contents of Kit	Product Code	
	JHW4M04T	JHW4M10T
Hand Pump	X	X
Ram	X	X
Hose Assembly	X	X
Hose Coupler	X	X
Ram Coupler	X	X
Case	X	X
Hydraulic Spreader	X	X
Combination Head (90°)	X	X
Rubber Head	X	X
Ram Toe	X	X
Plunger Toe	X	X
Flat Base	X	X
Serrated Saddle	X	X
Wedge Head	X	X
Male Connector	X	X
Extension Tubes Included	3"	4"
	6 1/4"	10"
	8 1/2"	18"
	16 1/2"	27"
	19 1/2"	

Capacity (tons)	Product Code	Ram		Number of Attachments
		Collapsed Height (in ²)	Extended Height (in ²)	
4	JHW4M04T	11.00	15.75	14
10	JHW4M10T	13.63	19.75	13

*When extension tubes and/or offset attachments are used, the capacity is reduced.

GAUGES, ADAPTERS, HOSES & HYDRAULIC OIL



JHW8G025W

JHW8G04W

GAUGE SPECIFICATIONS

Gauge Type	Product Code	Face Dia.	Thread	Pressure Range		Graduation			
		(in)	(in)	(psi)	(bar)	Major	Minor	Major	Minor
						(psi)		(bar)	
Wet	JHW8G025W	2.50	¼"-18NPTF	0-10,000	0-700	1,000	100	100	10
	JHW8G04W	4.00				2,000	200		

INDUSTRIAL HYDRAULICS



JHW8FG38MF

GAUGE ADAPTER SPECIFICATIONS

Product Code	Dimensions (in)					
	A	B	C	D	E	F
JHW8FG38MF	5.12	1.38	¼"-18NPTF	¾"-18NPTF	¾"-18NPTF	1.25

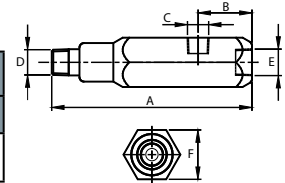

JHW8FB25F38M



JHW8FR38M25F

ADAPTER SPECIFICATIONS

Description	Product Code	Male Thread	Female Thread	Dimensions (in)	
		C	D	A	B
Adapter	JHW8FR38M25F	¼"-18NPTF	¾"-18NPTF	1.39	0.91
Bushing	JHW8FB25F38M	¾"-18NPTF	¼"-18NPTF	0.87	0.67

GAUGES, ADAPTERS, HOSES & HYDRAULIC OIL



JHW8H3838D06

JHW8H2525D06



JHW8H3825D06

HOSE SPECIFICATIONS

Hose I.D.	Product Code	Hose End Fittings	Operating Pressure	Hose Length	Weight
(in)				(ft)	(lbs)
¼"	JHW8H2525D06	¼"-18NPTF	10,000	6	2.5
	JHW8H3825D06			6	3.0
	JHW8H3825D10	¾"-18NPTF		10	5.0
	JHW8H3825D20			20	10.5
¾"	JHW8H2538D06	¼"-18NPTF		6	3.2
	JHW8H3838D06			6	3.5
	JHW8H3838D10	¾"-18NPTF		10	6.5
	JHW8H3838D20			20	13.5



JHW8H1G

HYDRAULIC OIL

Volume	Product Code	Viscosity Index	Viscosity @ 100°F	Viscosity @ 210°F	ASTM Grade	Flash Point	Pour Point	API Gravity
(gal)		(min)	(S.U.S.)	(S.U.S.)		(°F)	(°F)	
1	JHW8H1G	168	215	47	215	410	-54	31.4



COUPLINGS/MALE CONNECTORS



COUPLING/MALE CONNECTOR DIMENSIONS

Product Code	Type	Dimensions			
		A (in)	B (in)	C	D
JHW8FC25F38F	Couplings	1.18	1.02	Female 1/4"-18NPTF	Female 3/8"-18NPTF
JHW8FC38F	Couplings	1.18	1.02	Female 3/8"-18NPTF	Female 3/8"-18NPTF
JHW8FN25M	Male Connectors	1.50	0.67	Male 1/4"-18NPTF	Male 1/4"-18NPTF
JHW8FN38M	Male Connectors	1.50	0.75	Male 3/8"-18NPTF	Male 3/8"-18NPTF
JHW8FN25M38M	Male Connectors	1.45	0.75	Male 1/4"-18NPTF	Male 3/8"-18NPTF

COUPLERS



COUPLER DIMENSIONS

Coupler Type	Product code			Dimensions (in)				
	Complete Set	Male Half	Female Half	A*	B	C	D	E
High-Flow Coupler	JHW8RH38D	JHW8RH38DM	JHW8RH38DF	3.35	2.84	3/4"-18NPTF	1 3/16"-16	1.10
Regular-Flow Coupler	JHW8R38D	JHW8R38DM	JHW8R38DF	3.15	2.2	3/4"-18NPTF	1 5/16"-20	1.04
Zinc Regular-Flow Coupler	JHWZCS1418	JHWZCM1418	JHWZCF1418	2.42	1.67	1/4"-18NPTF	0.95	0.83

* Value A is total length when male and female valves are connected.

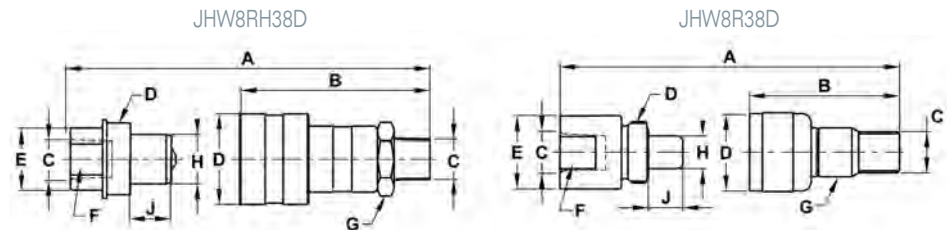

CYLINDER ACCESSORIES

CYLINDER DIMENSIONS

Product Code	Clevis Type	For use with Cylinder Capacity (Tons)
JHWCP05T	Plunger	5
JHWCP15T	Plunger	10
JHWCP25T	Plunger	25
JHWCPB05T	Plunger & Base	JHW6CP05T05
JHWCPB10T	Plunger & Base	JHW6CP10T06



FLOW CONTROL VALVES

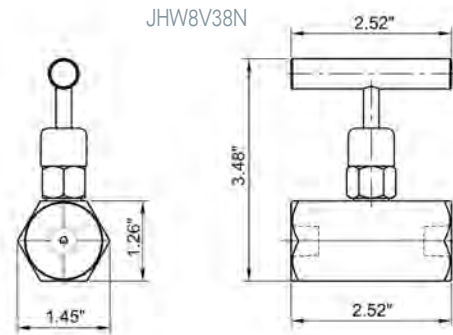
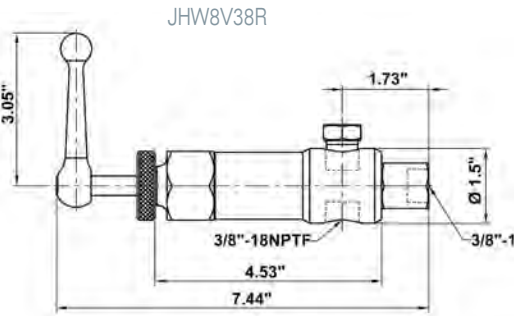

VALVE SPECIFICATIONS

Valve Type	Product Code	Ports	Application	Hydraulic Symbol
Needle Valve	JHW8V38N	3/8" - 18NPTF	Controls cylinder speed and treats as temporary shut-off valve for load holding.	
Pressure Relief Valve	JHW8V38R	3/8" - 18NPTF	Controls pressure developed by the pump in hydraulic loop. By-pass occurred when pre-set pressure is reached. Turns clockwise to increase pressure, counter clockwise to decrease.	

MANIFOLDS



Manifold Type	Product Code	Number of Parts	Port Size	Mounting Hole
7" Long Manifold	JHW8M7L7P	7	3/8" - 18NPTF	1/4" - 20UNC
14" Long Manifold	JHW8M14L7P	7		

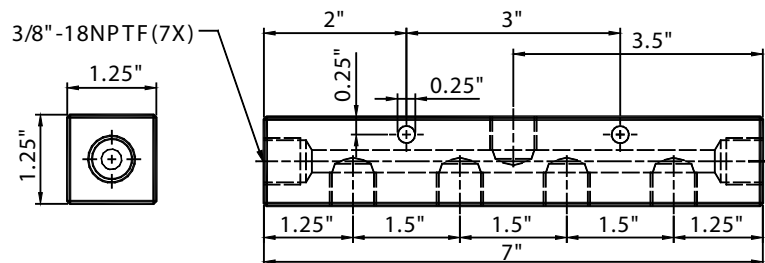

TOOLS FOR THE TRADES

TRADE KITS	426
HANDSAWS	428
BOWSAWS	436
HACKSAWS	438
PORTABANDS	441
HOLESAWS	442
RECIPROCATING SAW BLADES	452
FILES	463
MEASURING TOOLS	486
EYEBOLTS	494
KNIVES	498
WORKLIGHTS	501
PICKUP TOOLS	502



BI-METAL SANDFLEX HOLESAWS



Made with 8% cobalt to ensure a longer holesaw life

Range 9/16" to 6" has a 6° positive tooth angle for aggressive cutting

shatterproof bi-metal body for more safety

Simple holesaw selection thanks to the printed material information

MULTI-CONSTRUCTION SUPERIOR™ HOLESAWS

Permanent laser marking of the size in millimeters and inches

Wide gullets for fast and effective chip removal

Special coating minimizes heat and friction

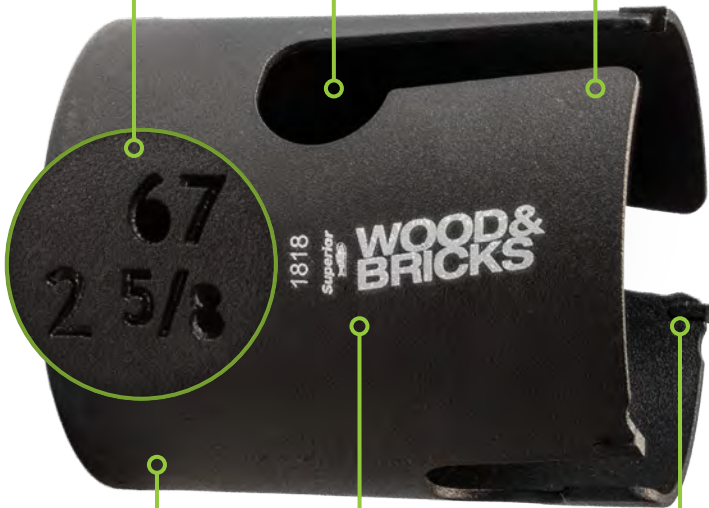

Cutting depth of 2 13/16"

Printed material information makes holesaw selection simple

Precision tooth geometry provides instant penetration

CARBIDE-TIPPED HOLESAWS

Ideal for making high-precision holes in hard material such as ceramic tiles, stone, fiberglass, laminate, hardwood and high demanding steel materials

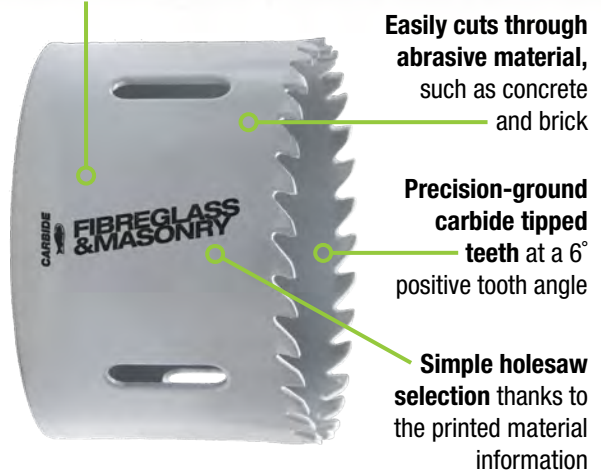

Easily cuts through abrasive material, such as concrete and brick

Precision-ground carbide tipped teeth at a 6° positive tooth angle

Simple holesaw selection thanks to the printed material information

QUICK-EJECT ARBOR

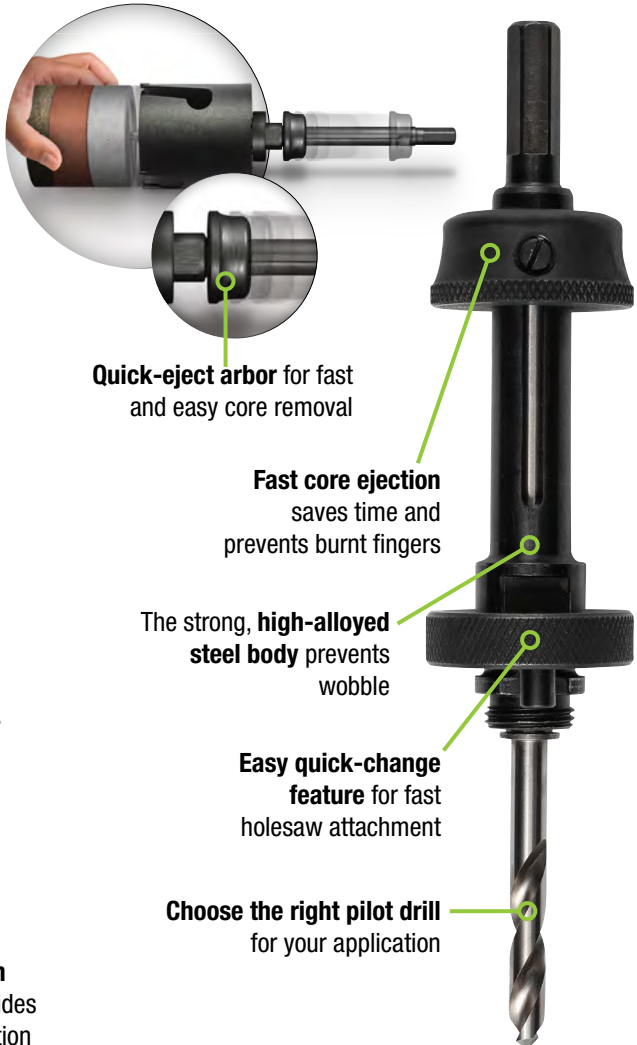

Quick-eject arbor for fast and easy core removal

Fast core ejection saves time and prevents burnt fingers

The strong, high-alloyed steel body prevents wobble

Easy quick-change feature for fast holesaw attachment

Choose the right pilot drill for your application

TOOLS FOR THE TRADES

FAST, CLEAN, ACCURATE CUTS.

RECIPROCATING SAW BLADES

BLADES FOR METAL



Simple saw blade selection thanks to the printed material information

Sharp long-life teeth (HSS 8% Cobalt)

Easier penetration thanks to precision-ground tooth geometry

BLADES FOR WOOD AND METAL



Simple saw blade selection thanks to the printed material information

Specially made for aggressive straight cuts

Long-life teeth (HSS 8% Cobalt)

BLADES FOR WOOD AND PLASTIC

Simple saw blade selection thanks to the printed material information

Strong high-carbon steel blades

Low-friction coating minimizes heat generation



Bevel-ground wood-cutting toothing allows faster cross-cutting and rip-cutting

Long-lasting induction-hardened teeth

SABRE SAW BLADES FOR SPECIAL APPLICATIONS



Simple saw blade selection thanks to the printed material information

Carbide tipped teeth are ideal for demanding applications

For fast and aggressive straight cuts

BAHCO® 42 PIECE ELECTRICIAN'S KIT

Product Code	Description
4750FB3-12TS4	42 Piece Large Electrician's Kit

Contents Include:

12" Electrician's Bag with Hard Bottom
Flat File Ergo™ 8" Second 36 TPI
Round File Ergo™ 8" Second 36 TPI
10mm Combination Wrench
13mm Combination Wrench
Long Ball End Hexagon Key Set, Metric
Diagonal Cutting Plier 6 1/4"
Wire stripping pliers - copper wire and cable
Cable cutting and stripping pliers
Nose Plier 6 1/4"
Side Cutting Combo Plier 7"
Junior Hacksaw Plastic Handle 6"
Professional Light Hacksaw Frame
Center Punch
Flat Chisel
Chisel
Spirit Level
Claw Hammer
Warrington Hammer
Precision Screwdrivers: slotted
Black Adjustable Wrench 6"
Black Adjustable Wrench 8"
Quick Adjust Water Pump Plier
Insulated Slotted Screwdriver (6)
Insulated Pozidriv Screwdriver (2)
Multipurpose Knife
Screwdriver Robertson # 1
Screwdriver Robertson # 2
Screwdriver Robertson # 3

Features

- This Electrician's kit provides the tools necessary for many electrical applications
- Kit contains an assortment of pliers, screwdrivers, adjustable wrench, combination wrenches, files and knife
- Packed in an Electrician's bag with a hard bottom and double stitching reinforcement that is 100% waterproof and easy to clean



4750FB3-12TS4

BAHCO® 13 PIECE BASIC MAINTENANCE KIT

Product Code	Description
4750-UP-1TS5	13 Piece Basic Maintenance Kit

Contents Include:

Universal Pouch	10mm Combination Wrench
Diagonal Cutting Plier 6 1/4"	11mm Combination Wrench
Side Cutting Combo Plier 7"	13mm Combination Wrench
Nose Plier Grips 6 1/4"	Screwdriver Robertson # 1
Slotted Screwdriver	Screwdriver Robertson # 2
Phillips PH1 Screwdriver	Screwdriver Robertson # 3
Black Adjustable Wrench 10"	

Features

- This basic maintenance kit provides the tools necessary for many general service and maintenance applications
- Kit contains an assortment of pliers, screwdrivers, adjustable wrench and combination wrenches
- Packed in a universal pouch with leather slots and two deep multi purpose open pockets



4750-UP-1TS5



3100TBTS4

BAHCO® 30 PIECE PLUMBERS KIT

Product Code	Description
3100TBTS4	30 Piece Plumbers Kit

Contents Include:

17" Open Tote Caddy Tool Bag Organizer
 Screwdriver Slotted Ergo™ 8 3/4 x 4 x 5/32"
 Screwdriver Ergo™ Pozidriv® #2
 Screwdriver Slotted Ergo™ 9 3/4 x 5 x 1/4"
 Screwdriver Phillips® Ergo™ #1

Hex Keys

Stubby Awl

Hacksaw Non-Slip Handles 12"

Junior Hacksaw Plastic Handle 6"

Homeowner's File Ergo™ 8" 41 & 36 TPI

Spirit Level

Claw Hammer

Universal Pipe Wrench 11"

Universal Pipe Wrench 14 1/2"

Adjustable Joint Pliers 10"

Tube Cutter

Tube Cutter

Wheel Reamer

Multipurpose Knife

Wrecking Knife

Black Adjustable Wrench 8"

Black Adjustable Wrench 6"

Cold Chisel

Pencil

Features

- This plumbers kit provides the tools necessary for many plumbing applications
- This set is geared for industrial plumbers. It includes an assortment of hand tools such as screwdrivers, wrenches, hacksaws and tube cutters
- Packed in a open tote caddy tool bag organizer, ideal for storing and carrying tools, parts and supplies

BAHCO® 52 PIECE GENERAL PURPOSE KIT

Product Code	Description
4750PTB65TS4	52 Piece General Purpose Kit

Contents Include:

Plastic Tool Box

Knife

Wrecking Knife

Torpedo Level

Ergo™ Claw Hammer

31 Piece Bit set in Plastic Case

Screwdriver Set 6 Pieces

Square

Sliding Bevel

Prize Cut 22" Handsaw, (Qty. 2)

Tape Measure

Pencil

Nail Punches

Snap-off Knife

Screwdriver Robertson # 1

Screwdriver Robertson # 2

Screwdriver Robertson # 3

Features

- This general purpose kit provides the tools necessary for many general service and repair applications
- Kit contains an assortment of screwdrivers, hammer, tape measure and knives
- Packed in a heavy duty plastic tool box that is perfect for organizing items



4750PTB65TS4

BAHCO® LAPLANDER FOLDING SAW AND MULTIPURPOSE KNIFE

General Purpose Folding Saw

Product Code	Blade Length (Inch)	Teeth Per Inch
396-LAP	9	7

Multipurpose Knife

Product Code	Overall Length (Inch)
2444-LAP	9

Saw and Knife Set

Product Code	Description
LAP-KNIFE	Folding saw & Multipurpose Knife

Features

- A general purpose folding saw for cutting both green and dry wood, plastic, bone etc.
- Specially designed for wild-life enthusiasts, hunting and campers.
- XT toothing, 7TPI. Blade specially coated for rust protection and low friction
- Two-component plastic handle for perfect grip, with leather strap.
- Safety lock, locked also when folded



BAHCO® JAPANESE STYLE PULL SAWS

Cut on Pull Stroke

Product Code	Blade Length (Inch)	Teeth Per Inch (TPI)
PC-12-14-PS	12	14
PC-11-19-PS	11	19
PC-9-9/17-PS	9	9/17

Features

- Razor sharp teeth allows this pull saw to make clean cuts with little effort.
- Perfect for rip and cross-cut to flush-cutting moldings, treated lumber, door casings, PVC, ABS pipe, hard and soft woods, plywood, drywall and plastic pipe.
- This pull-to-cut saw allows undercutting with fast and accurate cuts.



BAHCO® PRIZECUT TOOLBOX HANDSAW

Product Code	Blade Length (Inch)	Teeth Per Inch (TPI)
300-14-F15/16-HP	14	15/16

Features

- The universal toothing is strong and hard wearing, suitable for both rip and cross cutting in all types of wood
- Hard Point for longer life, rust protection lacquered
- One-component solid handle
- Comes with reusable plastic patented tooth protector



BAHCO® PROFCUT TOOLBOX HANDSAW

Special-purpose Handsaw

Product Code	Blade Length (Inch)	Teeth Per Inch (TPI)
PC-15-TBX	15	11

Features

- Toolbox saw for fine cutting
- Fine GT toothing, 11 TPI
- Super sharp GT-toothing is specially developed for high cutting performance
- The 3-sided ground tooth form ensures excellent results in all types of wood
- Comfortable-two component handle
- Comes with reusable plastic patented tooth protector





SUP-20-LAM

BAHCO® ERGO™ SUPERIOR LAMINATOR SAW

Ergo™ handle - Unique XT toothing -
Low Friction Coating

Product Code	Blade Length (Inch)	Teeth Per Inch (TPI)	Type of cut
SUP-20-LAM	20	11/12	Fine

Features

- A handsaw for cutting laminate and wooden floors
- Bevel ground teeth on thick blade for high precision and straight cutting with exceptionally good stability
- Screwed, one piece two-component Ergo™ handle
- Handle placement provides even distribution of power along the tooth line
- Low-friction, rust-protective coating
- Comes with reusable plastic patented tooth protector



PC-22-GT7

BAHCO® PROFCUT GENERAL PURPOSE HANDSAWS

Comfortable two-component handle

Product Code	Blade Length (Inch)	Teeth Per Inch (TPI)
PC-19-GT7	19	7
PC-22-GT7	22	7
PC-22-FILE-U7	22	7 (Fileable)

Features

- Super sharp GT-toothing is specially developed for high cutting performance
- The 3-sided ground tooth form ensures excellent results in all types of wood
- Comfortable-two component handle
- Comes with reusable plastic patented tooth protector



NP-22-U7/8-HP

BAHCO® PRIZECUT UNIVERSAL SAW

Product Code	Blade Length (Inch)	Teeth Per Inch (TPI)
NP-16-U7/8-HP	16	7
NP-19-U7/8-HP	19	7
NP-22-U7/8-HP	22	7

Features

- The universal toothing is strong and hard wearing, suitable for both rip and cross cutting in all types of wood
- Hard Point for longer life, rust protection lacquered
- Two-component solid handle
- Comes with reusable plastic patented tooth protector

BAHCO® SUPERIOR HANDSAWS WITH XT TOOTHING

Ergo™ handle - Unique XT toothing - Low Friction Coating

Product Code	Blade Length (Inch)	Teeth Per Inch (TPI)	Type of cut
Fine Tooth Pattern for smooth, consistent cuts through most materials			
2600-16-XT11-HP	16	11	Fine
2600-22-XT-HP	22	9	Medium
Aggressive tooth pattern for faster cuts through thick material			
2700-22-XT7-HP	22	7	Aggressive
2700-24-XT7-HP	24	7	Aggressive

Features

- Hard point saw with substantially thicker blade which results in less power-consuming side vibrations
- Bevel ground teeth on thick blade for height precision and straight cutting with exceptionally good stability
- Screwed, one piece two-component Ergo™ handle
- Handle placement provides even distribution of power along the tooth line
- Comes with reusable plastic patented tooth protector



2600-16-XT11-HP

BAHCO® SUPERIOR MITER HANDSAW WITH XT TOOTHING

Ergo™ handle - Unique XT toothing - Low Friction Coating

Product Code	Blade Length (Inch)	Teeth Per Inch (TPI)	Type of cut
3090-20-XT11-HP	20	11	Fine

Features

- Bevel ground teeth on thick blade for high precision and straight cutting with exceptionally good stability
- Screwed, one piece two-component Ergo™ handle
- Handle placement provides even distribution of power along the tooth line
- Comes with reusable plastic patented tooth protector



3090-20-XT11-HP

BAHCO® PROFESSIONAL HANDSAWS WITH XT TOOTHING

Ergo™ handle - Unique XT toothing - Low Friction Coating

Product Code	Blade Length (Inch)	Teeth Per Inch (TPI)	Type of cut
2500-16-XT-HP	16	9	Medium
2500-19-XT-HP	19	9	Medium
2500-22-XT-HP	22	9	Medium

Features

- For medium thick materials, such as plywood, ordinary wood, fiber and chipboard or plastics
- Hard point saw with substantially thicker blade which results in less power-consuming side vibrations
- Screwed, one piece two-component Ergo™ handle
- Handle placement provides even distribution of power along the tooth line
- Comes with reusable plastic patented tooth protector



2500-16-XT-HP

BAHCO® PROFCUT TOOLBOX HANDSAW

Comfortable two-component handle

Product Code	Blade Length (Inches)	Teeth Per Inch (TPI)
PC-15-GNP	15	15

Features

- Toolbox saw for general purpose cutting
- Fine FT toothing, 15 TPI
- Saw blade for cutting plastics, laminates, wood and soft metals like aluminum
Fleam toothing, hardpoint teeth for long lasting sharpness
- Comfortable-two component handle
- Comes with reusable plastic patented tooth protector



PC-15-GNP



3180-14-XT11-HP



PC-12-TEN



NP-12-TEN



PC-10-DTF



PC-10-DTR

BAHCO® SUPERIOR BACKSAW WITH XT TOOTHING

Ergo™ handle - Unique XT tooting - Low Friction Coating

Product Code	Blade Length (Inch)	Teeth Per Inch (TPI)	Type of cut
3180-14-XT11-HP	14	11	Fine

Features

- Specially adapted for cutting of small-diameter timber and miter guide sawing of all sizes of materials
- Bevel ground teeth on thick blade for high precision and straight cutting with exceptionally good stability
- Screwed, one piece two-component Ergo™ handle
- Handle placement provides even distribution of power along the tooth line
- Comes with reusable plastic patented tooth protector

BAHCO® PROFCUT BACKSAW

For Straight and Miter Cuts

Product Code	Blade Length (Inch)	Teeth Per Inch (TPI)
PC-12-TEN	12	11

Features

- Specially adapted for cutting of small-diameter timber and miter guide sawing of all sizes of materials
- Fine UT tooting with 11 TPI
- The universal tooting is strong and hard wearing, suitable for both rip and cross cutting in all types of wood
- 3-sided ground tooth form ensures excellent results in all types of wood
- Comfortable two component handle
- Comes with reusable plastic patented tooth protector

BAHCO® PRIZECUT BACKSAW

Product Code	Blade Length (Inch)	Teeth Per Inch (TPI)
NP-12-TEN	12	13

Features

- Specially adapted for cutting of small-diameter timber and miter guide sawing, all sizes of materials
- The universal tooting is strong and hard wearing, suitable for both rip and cross cutting in all types of wood
- Hard Point for longer life, rust protection lacquered
- One-component solid handle
- Comes with reusable plastic patented tooth protector

BAHCO® PROFCUT DOVETAIL HANDSAWS

Fine Cut Detail Saws

Product Code	Style	Blade Length (Inch)	Teeth Per Inch (TPI)
PC-10-DTF	Reversible handle for left / right sawing	10	15/16
PC-10-DTR	Angled / flush cutting	10	13/14

Features

- Special-purpose saw for wood and plastic materials
- Fine universal tooting with hard point teeth and light steel back for rigidity
- Blade width is 2-3/8"
- Comes with reusable plastic patented tooth protector

BAHCO® SUPERIOR VENEER SAW WITH XT TOOTHING

Ergo™ handle - Unique XT tooting -
Low Friction Coating

Product Code	Blade Length (Inch)	Teeth Per Inch (TPI)	Type of cut
3240-14-XT11-HP	14	11	Fine

Features

- For fine and medium thick materials, such as plywood, laminates and plastics
- Bevel ground teeth on thick blade for high precision and straight cutting with exceptionally good stability
- Curved, toothed nose for starting cuts in the middle of the surface of the work piece
- Screwed, one piece two-component Ergo™ handle
- Handle placement provides even distribution of power along the tooth line
- Comes with reusable plastic patented tooth protector



3240-14-XT11-HP

BAHCO® PROFCUT VENEER SAW

For Veneer and Other Fine Sawing

Product Code	Blade Length (Inch)	Teeth Per Inch (TPI)
PC-12-VEN	12	11

Features

- For fine and medium thick materials, such as plywood, laminates and plastics
- Fine UT tooting with 11 TPI
- Rounded cutting nose for pocket cuts
- The universal tooting is strong and hard wearing, suitable for both rip and cross cutting in all types of wood
- 3-sided ground tooth form ensures excellent results in all types of wood
- Comfortable-two component handle
- Comes with reusable plastic patented tooth protector



PC-12-VEN

BAHCO® PRIZECUT VENEER SAW

Product Code	Blade Length (Inch)	Teeth Per Inch (TPI)
NP-12-VEN	12	13

Features

- For fine and medium thick materials, such as plywood, laminates and plastics
- The universal tooting is strong and hard wearing, suitable for both rip and cross cutting in all types of wood
- Hard Point for longer life, rust protection lacquered
- Two-component solid handle
- Comes with reusable plastic patented tooth protector



NP-12-VEN



3150-12-XT9-HP

BAHCO® SUPERIOR COMPASS SAW WITH XT TOOTHING

Unique XT tothing - Low Friction Coating

Product Code	Blade Length (Inch)	Teeth Per Inch (TPI)	Type of cut
3150-12-XT9-HP	12	9	Medium

Features

- For all kinds of woods and plastics
- Bevel ground teeth on thick blade for high precision and straight cutting
- Exceptionally good stability, working more on pull than on push
- Handle placement provides even distribution of power along the tooth line
- Comes with reusable plastic patented tooth protector



PC-12-COM

BAHCO® PROFCUT COMPASS HANDSAWS

For Contour Cuts

Product Code	Blade Length (Inch)	Teeth Per Inch (TPI)
PC-12-COM	12	9

Features

- For all kinds of wood and plastic material
- Long lasting sharpness from the unique XT-tothing, hardpoint teeth
- Handle placement provides even distribution of power along the tooth line
- Comfortable-two component handle
- Comes with reusable plastic patented tooth protector

HANDSAWS

TOOLS FOR THE TRADES



NP-12-COM

BAHCO® PRIZECUT COMPASS HANDSAWS

Product Code	Blade Length (Inch)	Teeth Per Inch (TPI)
NP-12-COM	12	7

Features

- For all kinds of wood and plastic material
- The universal tothing is strong and hard wearing, suitable for both rip and cross cutting in all types of wood
- Hard Point for longer life, rust protection lacquered
- One-component solid handle
- Comes with reusable plastic patented tooth protector



PC-6-DRY

BAHCO® DRY WALL SAW

Jab Saw

Product Code	Blade Length (Inch)
PC-6-DRY	6

Features

- Cuts drywall, wallboard, plywood, and plastic
- Blade cuts in both directions (push and pull)
- Sturdy blade with sharp point for punching through drywall

BAHCO® PROFCUT INSULATION SAW

Special Purpose Saw

Product Code	Blade Length (Inch)	Teeth Per Inch
PC-22-INS	22	WT Tothing

Features

- Specially designed for cutting insulation material
- Mineral wood
- Cuts plastic up to 3/4" thick
- Cuts Styrofoam up to 3/4" thick
- Handsaw has a wave formed sharpened edge (WT tothing) that allows it to slice through the material creating minimal wast
- Should be stored in sleeve for rust protection



PC-22-INS

BAHCO® PROFCUT TIMBER SAW

Comfortable two-component handle with Fileable Blade

Product Code	Blade Length (Inch)	Teeth Per Inch
PC-24-TIM	24	3 1/2

Features

- A handsaw for cutting Timber
- Fleam-toothed, non-hardpoint
- Can be re-sharpened by using the file 272 Effective on the push as well as on the pull stroke
- Comfortable-two component handle
- Comes with reusable plastic patented tooth protector



PC-24-TIM

BAHCO® PROFCUT POLYSTYRENE, FOAM HANDSAW

Special-purpose handsaw

Product Code	Blade Length (Inch)	Teeth Per Inch (TPI)
PC-16-DECO	16	Special

Features

- Special tothing for cutting polystyrene and foam
- Specially developed tothing with very fine ground teeth and gullets designed to combine excellent finish with minimized clogging
- Comfortable-two component handle
- Comes with reusable plastic patented tooth protector



PC-16-DECO

BAHCO® PROFCUT LAMINATOR SAW

Special-purpose handsaw

Product Code	Blade Length (Inch)	Teeth Per Inch
PC-20-LAM	20	11/12

Features

- A handsaw for cutting laminate and wooden floors
- Long lasting sharpness from the unique XT-tothing, hardpoint teeth
- Comfortable-two component handle
- Comes with reusable plastic patented tooth protector



PC-20-LAM



PC-24-PLS

BAHCO® PROFCUT PLASTER SAW

Special-purpose Handsaw

Product Code	Blade Length (Inch)	Teeth Per Inch
PC-24-PLS	24	7

Features

- A handsaw for cutting plaster
- Super sharp GT-toothing is specially developed for high cutting performance
- The 3-sided ground tooth form ensures excellent results in all types of wood
- Comfortable two component handle
- Comes with reusable plastic patented tooth protector



296

BAHCO® STRADIVARIUS - MUSICAL SAW

Specially made for musical applications

Product Code	Blade Length (Inch)
296	30

Features

- Polished blade with flat back and un-ground teeth, total length 34 1/4"
- Specially made for musical applications
- Traditional wood handle with brass hardware



301



303-5p

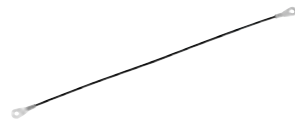

216-150-R

BAHCO® COPING SAW

Wooden beech handle

Product Code	Description	Blade Length (Inch)	Teeth Per Inch
301	Coping Saw	6 1/2	14
303-5P	Coping Saw Blades (5 Pack)	6 1/2	14
216-150-R	Rod Blade	6	Grit

Features

- Nickel-plated steel frame. Orange-lacquered, wooden beech handle
- Interchangeable blade fitted on retaining pins, turnable 360°
- Blade of hardened and tempered carbon steel, teeth milled and set, 14 TPI

BAHCO® MINI BOWHACK

Durable Metal Handle

Product Code	Blade Length (Inch)	Type of Wood
9-12-51/3806-KP	12	Dry Wood and Lumber

Features

- Toolbox sized mini-bow saw is easy to stow away and is ideal for plumbers and electricians
- Made of lightweight, high quality steel tubing for durability and easy handling
- High impact orange enamel paint protects from rust and corrosion
- Comes with 12" blade for wood cutting and a bi-metal hacksaw blade
- Equipped with durable metal handle



9-12-51/3806-KP

BAHCO® ECONOMY BOW SAWS

Durable Metal Handle

Product Code	Blade Length (Inch)
SE-16-21	21
SE-15-24	24
SE-15-30	30

Features

- Made of lightweight, quality steel tubing for durability and easy handling
- High impact orange enamel paint protects from rust and corrosion
- Pointed nose on 21" model ideal for use in tight spaces
- Durable metal handle



SE-16-21



SE-15-24

BAHCO® BOW SAW BLADES

Replacement blades

Product Code	Blade Length (Inch)	Type of Wood	Type of Tothing
23-21	21	Green Wood	Raker
23-24	24	Green Wood	Raker
23-30	30	Green Wood	Raker
23-36	36	Green Wood	Raker
51-12	12	Dry Wood and Lumber	Peg
51-21	21	Dry Wood and Lumber	Peg
51-24	24	Dry Wood and Lumber	Peg
51-30	30	Dry Wood and Lumber	Peg
51-36	36	Dry Wood and Lumber	Peg
51-42	42	Dry Wood and Lumber	Peg
333-5	14	Dry Wood	Raker

Features

- Rust-prevention treated
- Packed in individual sleeve printed with graphically illustrated text for correct blade selection



23-24



51-24



333-5



10-21-51

BAHCO® ERGO™ BOW SAWS

Ergonomically designed handle

Product Code	Blade Length (Inch)	Type of Wood
10-21-51	21	Dry Wood and Lumber
10-24-51	24	Dry Wood and Lumber
10-24-23	24	Green Wood
10-30-23	30	Green Wood
10-30-51	30	Dry Wood and Lumber
9-36-23-KP*	36	Dry Wood and Lumber

* Equipped with non-Ergo™ metal handle

Features

- Designed for demanding applications and tough environments of construction sites
- Innovative tensioning mechanism for high blade tension and straight cutting
- Ergo™ handle with knuckle protector provides comfort and safety
- Made of lightweight, high quality steel tubing for durability and easy handling
- High impact orange enamel paint protects from rust and corrosion
- Strong blade fitting for easy and safe blade storage



332



331

BAHCO® BOW SAWS - POINTED NOSE

Durable Handle

Product Code	Blade Length (Inch)	Type of Wood	Handle
332-21-51	21	Dry Wood and Lumber	Ergo™
331-21-51-KP	21	Dry Wood and Lumber	Standard

Features

- Small and handy bow saw for all around use
- Pointed nose makes the saw ideal for use in tight spaces
- Used for pruning and roofing work
- Model 332 is equipped with an Ergo™ handle



333

BAHCO® BOW SAW - QUICK CHANGE

Equipped With Raker Blade for Cutting Dry Wood

Product Code	Blade Length (Inch)
333	14
333-5	Replacement Blade

Features

- The steel frame has special blade holders with a extra strong blade attachment mechanism
- Reversible blade, hardened for durability which can be rotated around its long axis
- Equipped with durable plastic handle
- Handle releases for quick blade changes

BAHCO® ERGO™ PROFESSIONAL HAND HACKSAW

Ergonomic Handles Maximize Cutting Control and Power

Product Code	Description	Blade Length (Inches)
325	Ergo™ Hand Hacksaw	12

Features

- Ergonomically designed with extremely high blade tension for straight, accurate and fast cuts
- Centered blade for correct balance and reduced cutting effort
- Alternative 55° blade mounting for flush cutting
- Supplied with reliable and shatterproof 12 inch bi-metal blade, 24 TPI
- Single touch spring loaded blade release mechanism for fast blade changes
- Winner of the Silver Award from the Industrial Designers Society of America



325

BAHCO® PROFESSIONAL HAND HACKSAW

Non-Slip Handles Ensures a Solid and Secure Grip.

Product Code	Description	Blade Length (Inches)
319	Professional Hand Hacksaw	12

Features

- Alternative 55° blade mounting for flush cutting
- Offers a strong steel frame that is covered with a protective dual component plastic
- Comfortable, non-slip back handle and front grip ensures a solid, secure grip
- Tension mechanism is fully integrated into the handles so there is no obstruction during use
- Supplied with reliable and shatterproof 12 inch bi-metal blade, 24 TPI



319

BAHCO® TRADESMAN'S HAND HACKSAW

Durable Aluminum Handle

Product Code	Description	Blade Length (Inches)
317	Tradesman's Hand Hacksaw	12

Features

- Alternative 90° blade mounting
- Light and comfortable frame for difficult-to-reach applications
- Durable aluminum handle
- Metal tensioning lever designed to be comfortable and unobtrusive
- Supplied with BAHCO® Bimetal blade for safety and efficiency



317

BAHCO® TRADITIONAL HAND HACKSAW

Heavy Duty Frame with Blade Storage

Product Code	Description	Blade Length (Inches)
225-PLUS	Traditional Hand Hacksaw	12

Features

- Allows very high blade tension for accurate and fast cuts
- Strong rectangular back section for blade storage with easy-to-handle retaining screws
- Can also be used as a compass saw
- Alternative 55° blade mounting for flush cutting
- Supplied with reliable and shatterproof 12 inch bi-metal blade, 24 TPI



225-PLUS



BAHCO® LIGHTWEIGHT HAND HACKSAW

Durable Aluminum Handle

Product Code	Description	Blade Length (Inches)
306	Lightweight Hand Hacksaw	10 & 12

Features

- Alternative 90° blade mounting.
- Accepts both 10" and 12" blades.
- Ultra light, only 11 ounces.
- Supplied with BAHCO® Bimetal blade for safety and efficiency.



BAHCO® MINI HACKSAW

Frame with Solid Steel Profile

Product Code	Description	Blade Length (Inches)
268	Mini Hacksaw	6

Features

- Chrome filled and fitted with a fiberglass handle to give a good and comfortable grip
- Supplied with reliable and shatterproof 10 inch bi-metal blade, 24 TPI
- Practical and simple blade-tensioning screw



BAHCO® MINI HACKSAW

Blade-Tensioning Handle

Product Code	Description	Blade Length (Inches)
228	Mini Hacksaw	6

Features

- Simple and quick, twist-action, blade-tensioning handle, made of beech wood and orange lacquered
- Complete with 6 inch, 32 TPI blade for metal cutting



BAHCO® MINI HACKSAW

Metal Cutting

Product Code	Description	Blade Length (Inches)
218	Mini Hacksaw	6

Features

- Complete with 6 inch, 32 TPI blade for metal cutting



BAHCO® MINI EXTENDABLE HACKSAW

Perfect for Difficult to Reach Work

Product Code	Description	Blade Length (Inches)
208	Mini Extendable Hacksaw	10

Features

- A mini-hacksaw frame for difficult to reach positions
- Supplied with reliable and shatterproof 10 inch bi-metal blade, 24 TPI
- Blade position adjusts for maximum versatility

BAHCO® TUNGSTEN CARBIDE HACKSAW BLADE

Metal Cutting

Product Code	Description	Blade Length (Inches)
3816-300	Carbide grit hacksaw blade	12

Features

- Anti-corrosion treated, carbon steel blade back
- Tungsten carbide grit toothing
- Fits all 12" metal saw frames



3816-300

BAHCO® BIMETAL HAND HACKSAW BLADES

Virtually Unbreakable and Shatterproof Bimetal Blades for all Metal Sawing

Product Code	Length	Teeth Per Inch	Blades per Package (To order, add Pack Quantity to End of Product Code)				
			100	10P	5P	3P	2P
3818-300-PROG-	12	18/24/32 **	X		X		
3906-250-18-	10	18	X		X		
3906-250-24-	10	24	X		X		
3906-250-32-	10	32	X		X		
3906-300-14-	12	14	X	X	X		
3906-300-18-	12	18	X	X	X		X
3906-300-24-	12	24	X	X	X		X
3906-300-32-	12	32	X	X	X		X
3906-300-	12	1 ea 18/24/32					X

Features

- Blade back made of strong, flexible spring steel with a tooth line of high-alloyed super high speed steel
- Bimetal construction guarantees the blade to keep its sharpness for a long time
- Precision ground teeth for all kinds of metal sawing
- Combine extreme cutting performance and wear resistance with a high degree of flexibility
- Vastly superior to all-hard high speed blades or conventional, flexible blades
- **Progressive tooth hacksaw blade features 3-tooth patterns for fast starting and cutting
- Improved painting techniques allows for better cutting from the start with no paint in the gullets



Progressive Tooth Blade
3818-300-PROG-100



Hacksaw Blade, 18 TPI
3906-300-18-100



100 Pack

BAHCO® MINI HACKSAW BLADES

Anti-corrosion Treated, Carbon Steel Blades

Product Code	Blades per Package	Blade Length (Inches)	TPI	For Cutting
228-15-5P	5	6	15	Wood
228-32-5P	5	6	32	Metal

Features

- Made of hardened and tempered carbon steel
- Teeth milled and set

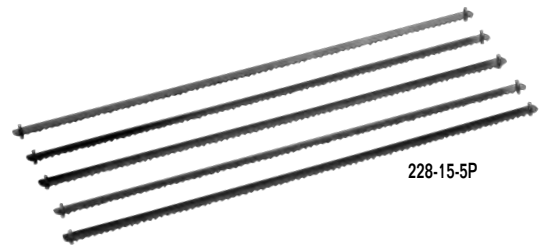

228-15-5P

BAHCO® ROD SAW BLADE

Suitable for Cutting Glass, Ceramics, Porcelain and Steel

Product Code	Blades per Package	Blade Length (Inches)	Fits
215-150	1	6	Mini Hacksaws
216-300-R	1	12	All 12" Hacksaws

Features

- Base steel rod coated with cemented carbide



215-150



215-300-R

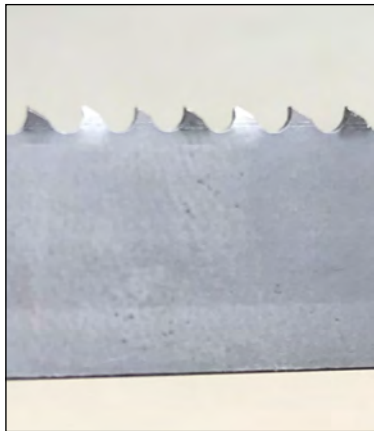

BI-METAL PORTABLE BANDSAW BLADES FOR HAND HELD MACHINES

Product Code	Dimensions (inch) (mm)		Length (inch) (mm)		Tooth Type	Teeth per inch	5 Pack
Loops							
PB13-0.5-R-10-1140-5P	1/2 x 0.020	13 x 0.50	44 7/8	1140	Regular	10	X
PB13-0.5-R-14-1140-5P	1/2 x 0.020	13 x 0.50	44 7/8	1140	Regular	14	X
PB13-0.5-R-18-1140-5P	1/2 x 0.020	13 x 0.50	44 7/8	1140	Regular	18	X
PB13-0.5-R-24-1140-5P	1/2 x 0.020	13 x 0.50	44 7/8	1140	Regular	24	X
PB13-0.5-10/14-1140-5P	1/2 x 0.020	13 x 0.50	44 7/8	1140	Combo	10/14	X
PB13-0.5-14/18-1140-5P	1/2 x 0.020	13 x 0.50	44 7/8	1140	Combo	14/18	X

Features

- A unique design for multipurpose and jobshop use that provides hand-held machines with fast cutting, easy feeding, exceptional control, and precision cutting on a variety of materials
- Perfect for cutting stainless steel, angle iron, bronze, copper, galvanized pipe, mild steel, aluminum, brass, chrome



BAHCO® HOLESAWS

BAHCO® Holesaws set the standard in precision, quality, durability and versatility. Whatever the job, you will find the Holesaws and accessories you need.

Each part of the Holesaw is designed to boost productivity and craftsmanship, from the design of the cutting edges to the technologies used in production. There is consistent quality and total control from making the Bi-Metal all the way to the finished Holesaw. In our own R&D department, we test and develop innovations to ensure that we stay ahead of the market. Our wide range of Holesaws and accessories will meet your needs for almost any material. They are compatible with all machine brands.

Complete Holesaw System

Looking for maximum performance and flexibility? BAHCO®'s line of arbors, extensions, pilot drills, ejector springs and adaptors are designed as a fully interchangeable system.





CUTTING SPEED RECOMMENDATIONS

To get maximum result out of each Holesaw, we recommend the following cutting speeds (RPM).

BI-METAL SANDFLEX HOLESAW

	 FE	 18/8	 Cast iron	 CuZn	 Alu	 Wood
9/16-3/4"	580-460	300-240	400-300	790-600	900-690	3000
25/32-1 3/16"	435-285	230-145	290-190	580-380	660-425	3000-2400
1 1/4-1 7/8"	275-180	140-90	180-120	360-240	410-270	2400-2100
2 - 3"	170-115	85-55	115-75	230-150	255-170	2000-1500
3 1/8 - 4 1/8"	110-80	55-40	70-55	140-110	165-120	1500-1000
4 1/4-6"	80-55	40-25	55-35	110-75	120-75	900-800

CARBIDE TIPPED HOLESAW

	 Fiberglass	 Laminate	 Brick	 Tiles
19/16-3/4"	2380-1790	1360-1020	1705-1280	680-510
25/32-1 3/16"	1700-1130	970-640	1210-810	480-320
1 1/4-1 7/8"	1070-710	610-410	770-510	310-205
2-3"	670-450	380-260	480-320	190-130
3 1/8-4 1/8"	430-320	250-185	310-235	125-92
4 1/4-6"	310-220	180-130	230-160	90-65

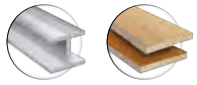
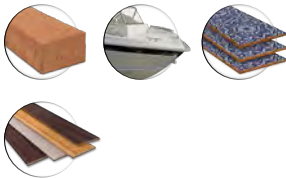

HOLESAW RANGE

	Multi-Construction Superior Holesaws	Bi-Metal Sandflex Holesaws	Carbide tipped holesaw
Range	 3/4"-6"	 9/16"-6"	 9/16"-6"
Application			
Sets	✓	✓	
Quick-Eject Arbors	3834-ARBR-930EL 3834-ARBR-9100EL	3834-ARBR-930ESM 3834-ARBR-9100ESM	3834-ARBR-930ES 3834-ARBR-9100ES
Standard Arbors	3834-ARBR-630 3834-ARBR-730 3834-ARBR-930 3834-ARBR-1130		
Quick Change Arbors	3834-ARBR-9100QC 3834-ARBR-11152QC 3834-ARBR-16152QC		
Power Driver™ Arbors	3834-ARBR-9100 3834-ARBR-11152 3834-ARBR-16152		
Arbors with SDS+ shank	3834-ARBR-SD30 3834-ARBR-SD152QC		
Pilot Drills Quick-Eject Arbors	3834-DRL-EL	3834-DRL-EL	3834-DRL-ES
Pilot Drills Standard Arbors	3834-DRL-L	3834-DRL	3834-DRL-CT
Upsize Adaptor	3834-UPSIZE		
Ejector Spring	3834-ES		
Arbor Adaptor	3834-ADP		
Arbor Extensions	3834-EXT		

ARBOR SELECTION DEPENDS ON THE SIZE OF THE HOLESAW.
LOOK FOR THE OVER VIEW ON PAGE 450

MULTI-CONSTRUCTION SUPERIOR™ HOLESAWS

GO STRAIGHT THROUGH A WALL IN ONE GO!

HOLESAWS

TOOLS FOR THE TRADES



BAHCO® Superior™ Holesaws 3/4" (19mm) to 6-17/64" (159mm)

The Superior holesaw from BAHCO® is perfect for making holes in wood, including manufactured wooden materials like MDF, as well as brick, lightweight concrete, plasterboard and hard plastics. The holesaws have an extreme cutting depth of 2-3/4" (71mm) which allows the user to go through many materials such as studs in one cut! The precision ground carbide tips and the superior low friction coating cut smoothly and require less pressure. The multi construction assortment offers a wide range of sizes and is a perfect match with the Quick-eject arbor.

BAHCO® QUICK EJECT ARBORS

Product Code	Fits Holesaws	Drill
3834-ARBR-930ES	Bimetal up to 30 mm	3834-DRL-ES
3834-ARBR-930EL	Superior up to 30 mm	3834-DRL-EL
3834-ARBR-9100ES	Bimetal 32 mm and larger	3834-DRL-ES
3834-ARBR-9100EL	Superior 32 mm and larger	3834-DRL-EL

Features

- Allows the user to save time by releasing the core from the holesaw in one simple, fast and efficient operation without burning your fingers on a hot holesaw or release adapter
- Quick eject arbors provides stable drilling in challenging environments
- Arbor comes with a solid round carbide tipped drill and there is no need to change the drill between applications



For Superior™ holesaw in combination with standard arbor.



3833-SET-101

BAHCO® 10 PIECE SUPERIOR™ HOLESAW SET

Product Code	Description
3833-SET-101	10 Piece Superior Holesaw Set

Contents Include:

- Superior Holesaw: 3/4, 7/8, 1 1/8, 1 3/8, 2, 2 1/2
- Arbors: 3834-ARBR-930EL, 3834-ARBR-9100EL
- Pilot Drill: 3834-DRL-EL

BAHCO® 13 PIECE SUPERIOR™ HOLESAW SET

Product Code	Description
3833-SET-201	10 Piece Superior Holesaw Set

Contents Include:

- Superior Holesaw: 3/4, 25/32, 1, 1 1/4, 1 5/8, 2, 2 7/8, 3, 3 1/4, 3 3/8
- Arbors: 3834-ARBR-930EL, 3834-ARBR-9100EL
- Pilot Drill: 3834-DRL-EL



3833-SET-201

BAHCO® INDIVIDUAL SUPERIOR™ HOLESAWS

Product Code	Diameter	
	(inch)	(mm)
3833-19-C	3/4	19
3833-20-C	25/32	20
3833-22-C	7/8	22
3833-25-C	1	25
3833-27-C	1 1/16	27
3833-29-C	1 1/8	29
3833-30-C	1 3/16	30
3833-32-C	1 1/4	32
3833-35-C	1 3/8	35
3833-38-C	1 1/2	38
3833-40-C	1 9/16	40
3833-41-C	1 5/8	41
3833-44-C	1 3/4	44
3833-48-C	1 7/8	48
3833-51-C	2	51
3833-54-C	2 1/8	54
3833-57-C	2 1/4	57
3833-60-C	2 3/8	60
3833-64-C	2 1/2	64
3833-65-C	2 9/16	65
3833-67-C	2 5/8	67
3833-68-C	2 11/16	68
3833-70-C	2 3/4	70
3833-73-C	2 7/8	73
3833-76-C	3	76
3833-77-C	3 1/32	77
3833-79-C	3 1/8	79
3833-83-C	3 1/4	83
3833-86-C	3 3/8	86
3833-89-C	3 1/2	89
3833-92-C	3 5/8	92
3833-95-C	3 3/4	95
3833-98-C	3 7/8	98
3833-102-C	4	102
3833-105-C	4 1/8	105
3833-108-C	4 1/4	108
3833-109-C	4 19/64	109
3833-111-C	4 3/8	111
3833-114-C	4 1/2	114
3833-121-C	4 3/4	121
3833-127-C	5	127
3833-140-C	5 1/2	140
3833-152-C	6	152
3833-159-C	6 17/64	159



- SUPERIOR Holesaws are perfect for cutting holes in wood, brick, concrete, plasterboard and hard plastics
- The holesaws have an extreme cutting depth of 2 3/4" (71mm)
- The precision ground carbide tips and superior low friction coating cut smoothly and require less pressure

BI-METAL SANDFLEX HOLESAWS

RESEARCHED, DEVELOPED AND MANUFACTURED BI-METAL HOLESAWS BY BAHCO®

BAHCO® Bi-Metal Holesaws

BAHCO® was the first to create a successful bi-metal blade that combines a flexible, shatter-resistant spring steel back with a high speed steel cutting edge to provide faster, more durable cutting power. With the latest generation of bi-metal holesaws, we take the technology even further.

The cutting edge (with 4 to 6 teeth per inch) is electron beam-welded to a tough alloy back, and then the teeth are precision ground to further increase cutting efficiency. The result is a holesaw that can cut clean, accurate holes in virtually any machinable material. Vertical slots allow easy core removal.

shatterproof bi-metal body for more safety

Simple holesaw selection thanks to the printed material information



Made with 8% cobalt to ensure a longer holesaw life

Range 14-152 mm has a 6° positive tooth angle for aggressive cutting

Range 168-210 mm has a 0° tooth angle to simplify cutting

BI-METAL HOLESAWS

TOOLS FOR THE TRADES

BAHCO® INDIVIDUAL BI-METAL HOLESAWS

Product Code	Dia. (inch)	Dia. (mm)	Product Code	Dia. (inch)	Dia. (mm)	Product Code	Dia. (inch)	Dia. (mm)
Individual Pack			3830-41-VIP	1 5/8	41	3830-79-VIP	3 1/8	79
3830-14-VIP	9/16	14	3830-43-VIP	1 11/16	43	3830-83-VIP	3 1/4	83
3830-16-VIP	5/8	16	3830-44-VIP	1 3/4	44	3830-86-VIP	3 3/8	86
3830-17-VIP	11/16	17	3830-46-VIP	1 13/16	46	3830-89-VIP	3 1/2	89
3830-19-VIP	3/4	19	3830-48-VIP	1 7/8	48	3830-92-VIP	3 5/8	92
3830-20-VIP	25/32	20	3830-51-VIP	2	51	3830-95-VIP	3 3/4	95
3830-21-VIP	13/16	21	3830-52-VIP	2 1/16	52	3830-98-VIP	3 7/8	98
3830-22-VIP	7/8	22	3830-54-VIP	2 1/8	54	3830-102-VIP	4	102
3830-24-VIP	15/16	24	3830-56-VIP	2 3/16	56	3830-105-VIP	4 1/8	105
3830-25-VIP	1	25	3830-57-VIP	2 1/4	57	3830-108-VIP	4 1/4	108
3830-27-VIP	1 1/16	27	3830-59-VIP	2 5/16	59	3830-111-VIP	4 3/8	111
3830-29-VIP	1 1/8	29	3830-60-VIP	2 3/8	60	3830-114-VIP	4 1/2	114
3830-30-VIP	1 3/16	30	3830-64-VIP	2 1/2	64	3830-121-VIP	4 3/4	121
3830-32-VIP	1 1/4	32	3830-65-VIP	2 9/16	65	3830-127-VIP	5	127
3830-33-VIP	1 5/16	33	3830-67-VIP	2 5/8	67	3830-133-VIP	5 1/8	133
3830-35-VIP	1 3/8	35	3830-68-VIP	2 11/16	68	3830-140-VIP	5 1/2	140
3830-37-VIP	1 7/16	37	3830-70-VIP	2 3/4	70	3830-146-VIP	5 3/4	146
3830-38-VIP	1 1/2	38	3830-73-VIP	2 7/8	73	3830-152-VIP	6	152
3830-40-VIP	1 9/16	40	3830-76-VIP	3	76			

BAHCO® 9 PIECE PLUMBER'S HOLESAW SET

The sizes that plumbers need most, with the cutting power that produces faster, cleaner holes.

Product Code	Description
862209	9 Piece Plumber's Holesaw Set

Contents Include:

- Holesaws: 3/4", 7/8", 1 1/8", 1 1/2", 1 3/4", 2 1/4"
- Arbors: 3834-ARBR-730 and 3834-ARBR-1152QC
- Fits holesaws 3/16"-19/16", 1 1/4"-6"
- Extension: 3834-EXT-1



862209

BAHCO® 9 PIECE ELECTRICIAN'S HOLESAW SET

The holesaws electrician's use every day. Offering superior performance and convenience.

Product Code	Description
862109	9 Piece Electrician's Holesaw Set

Contents Include:

- Holesaws: 7/8", 1 1/8", 1 3/8", 1 3/4", 2", 2 1/2"
- Arbors: 3834-ARBR-730 and 3834-ARBR-1152QC
- Fits holesaws 3/16"-19/16", 1 1/4"-6"
- Extension: 3834-EXT-1



862109



862007



862013



862017



862021

BAHCO® Bimetal Holesaw Sets

Assortments of holesaws and accessories most commonly used by the trades, especially electricians and plumbers. Each packed in a durable plastic carrying case for convenience.

BAHCO® 7 PIECE HOLESAW SET

Product Code _____
862007

Contents Include:

- Holesaws: 7/8", 1", 1 1/8", 1 1/4", 1 1/2"
- Arbor: 3834-ARBR-730
- Adapter: 3834-ADP
- Fits holesaws 9/16"-13/16", 1 1/4"-6"

BAHCO® 13 PIECE HOLESAW SET

Product Code _____
862013

Contents Include:

- Holesaws: 3/4", 7/8", 1 1/8", 1 3/8", 1 1/2", 1 3/4", 2", 2 1/4", 2 1/2"
- Arbors: 3834-ARBR-730 and 3834-ARBR-11152QC
- Fits holesaws 9/16"-1 3/16", 1 1/4"-6"
- Adapter: 3834-ADP
- Pilot Drill: 3834-DRL-1

BAHCO® 17 PIECE HOLESAW SET

Product Code _____
862017

Contents Include:

- Holesaws: 5/8", 3/4", 7/8", 1", 1 1/8", 1 1/4", 1 3/8", 1 1/2", 1 3/4", 2", 2 1/2", 3"
- Arbors: 3834-ARBR-730 and 3834-ARBR-11152QC
- Fits holesaws 9/16"-13/16", 1 1/4"-6"
- Adapter: 3834-ADP
- Pilot Drill: 3834-DRL-1 (3 pcs)

BAHCO® 21 PIECE HOLESAW SET

Product Code _____
862021

Contents Include:

- Holesaws: 3/4", 7/8", 1", 1 1/8", 1 3/8", 1 1/2", 1 3/4", 2", 2 1/4", 2 1/2", 3", 3 1/4", 3 5/8", 3 3/4", 4 1/8", 4 3/4"
- Arbors: 3834-ARBR-1130 and 3834-ARBR-11152QC
- Fits holesaws 9/16"-13/16", 1 1/4"-6"
- Pilot Drill: 3834-DRL-1 (3 pcs)

CARBIDE-TIPPED HOLESAWS

HIGHLY WEAR RESISTANT

BAHCO® Carbide-Tipped Holesaws

BAHCO® carbide holesaws are designed to quickly and cleanly cut precise holes in ceramics, bricks, slate, laminate, fiberglass and hardwood.

With 4 precision ground carbide tips per inch — fusion-welded to an alloy steel back — these holesaws provide an impressive combination of strength, cutting power and durability.

Equipped with vertical slots for easy core removal, carbide-tipped holesaws are available in diameters from 9/10" to 6"; cutting depth for all holesaws is 1 1/2".

Ideal for making high-precision holes in hard material such as ceramic tiles, stone, fiberglass, laminate and hardwood

Easily cuts through abrasive material, such as concrete and brick

Simple holesaw selection thanks to the printed material information

Precision-ground carbide tipped teeth at a 6° positive tooth angle



CARBIDE-TIPPED HOLESAWS

BAHCO® Carbide Tipped Holesaw Sets

For the professional who works with a wide variety of non-metallic surfaces, this set will cut through anything from hardwood to bricks.

BAHCO® 7 PIECE HOLESAW SET

Product Code
863307

Contents Include:

- Holesaws: 7/8", 1", 1 1/8", 1 1/4", 1 1/2"
- Arbor: 3834-ARBR-730
- Fits holesaws 9/16"-13/16"
- Adapter: 3834-ADP



863307

BAHCO® 13 PIECE HOLESAW SET

Product Code
863313

Contents Include:

- Holesaws: 3/4", 7/8", 1 1/8", 1 3/8", 1 1/2", 1 3/4", 2", 2 1/4", 2 1/2"
- Arbors: 3834-ARBR-730 and 3834-ARBR-1152QC
- Adapter: 3834-ADP
- Pilot Drill: 3834-DRL-1



863313

TOOLS FOR THE TRADES

BAHCO® INDIVIDUAL CARBIDE-TIPPED HOLESAWS



Product Code	Diameter	
	(inch)	(mm)
Individual Pack		
3832-14	9/16	14
3832-16	5/8	16
3832-17	11/16	17
3832-19	3/4	19
3832-20	25/32	20
3832-21	13/16	21
3832-22	7/8	22
3832-24	15/16	24
3832-25	1	25
3832-27	1 1/16	27
3832-29	1 1/8	29
3832-30	1 3/16	30
3832-32	1 1/4	32
3832-33	1 5/16	33
3832-35	1 3/8	35
3832-37	1 7/16	37
3832-38	1 1/2	38
3832-40	1 9/16	40
3832-41	1 5/8	41
3832-43	1 11/16	43
3832-44	1 3/4	44
3832-46	1 13/16	46
3832-48	1 7/8	48
3832-51	2	51
3832-52	2 1/16	52
3832-54	2 1/8	54
3832-56	2 3/16	56
3832-57	2 1/4	57
3832-59	2 5/16	59
3832-60	2 3/8	60
3832-64	2 1/2	64
3832-65	2 9/16	65
3832-67	2 5/8	67
3832-68	2 11/16	68
3832-70	2 3/4	70
3832-73	2 7/8	73
3832-76	3	76
3832-79	3 1/8	79
3832-83	3 1/4	83
3832-86	3 3/8	86
3832-89	3 1/2	89
3832-92	3 5/8	92
3832-95	3 3/4	95
3832-98	3 7/8	98
3832-102	4	102
3832-105	4 1/8	105
3832-108	4 1/4	108
3832-111	4 3/8	111
3832-114	4 1/2	114
3832-121	4 3/4	121
3832-127	5	127
3832-133	5 1/4	133
3832-140	5 1/2	140
3832-146	5 3/4	146
3832-152	6	152

CARBIDE-TIPPED HOLESAWS

TOOLS FOR THE TRADES

ARBORS & PILOT DRILLS

ADAPT TO EACH SITUATION FOR THE BEST RESULTS

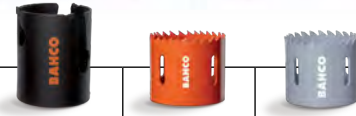

ARBORS & PILOT DRILLS

TOOLS FOR THE TRADES

HOLE SIZE UP TO 1 3/16"	Arbors	Pilot Drills			
	HOLE SIZE UP TO 1 3/16"	Arbors with Quick-Eject function for easily removing the core			
3834-ARBR-930EL		3834-DRL-EL	✓		
3834-ARBR-930ESM		3834-DRL-HSS-ES		✓	
3834-ARBR-930ES		3834-DRL-ES			✓
Standard Arbors		3834-DRL-L	✓		
3834-ARBR-630 3834-ARBR-730 3834-ARBR-930 3834-ARBR-1130		3834-DRL		✓	
		3834-DRL-CT			✓
Arbors with SDS+ shank For machines with Quick-Change chucks		3834-DRL-L	✓		
3834-ARBR-SD30		3834-DRL		✓	
		3834-DRL-CT			✓
HOLE SIZE 1 1/4" AND BIGGER	Arbors with Quick-Eject function for taking out the core easily				
	3834-ARBR-9100EL	3834-DRL-EL	✓		
	3834-ARBR-9100ESM	3834-DRL-HSS-ES		✓	
	3834-ARBR-9100ES	3834-DRL-ES			✓
	Quick-Change Arbors for easy Holesaw changes	3834-DRL-L	✓		
	3834-ARBR-9100QC 3834-ARBR-11152QC 3834-ARBR-16152QC	3834-DRL		✓	
		3834-DRL-CT			✓
	Power Driver™ Arbors for optimal stability	3834-DRL-L	✓		
	3834-ARBR-9100 3834-ARBR-11152 3834-ARBR-16152	3834-DRL		✓	
		3834-DRL-CT			✓
	Arbors with SDS+ shank For machines with Quick-Change chucks	3834-DRL-L	✓		
	3834-ARBR-SD152QC	3834-DRL		✓	
		3834-DRL-CT			✓

QUICK-EJECT ARBOR

SAVES TIME AND ENERGY

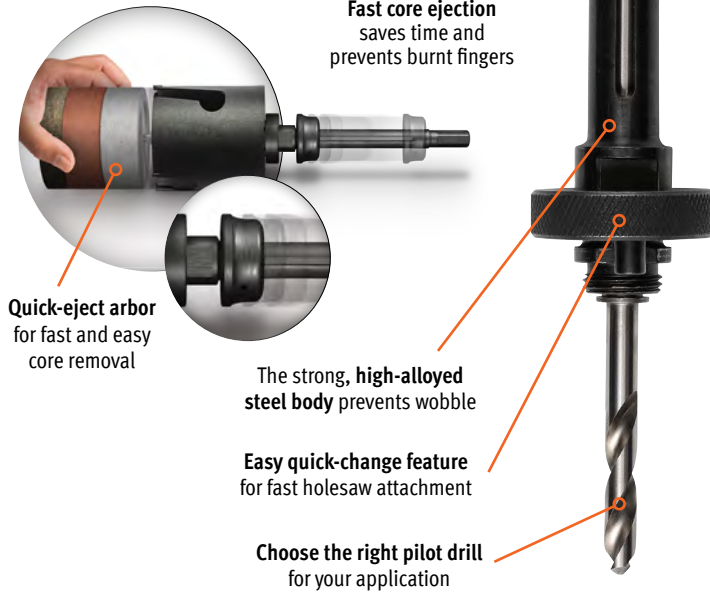

BAHCO® PILOT DRILLS

Product Code	Description
3834-DRL	For Non Quick Eject Arbors for Bi-Metal Holesaws
3834-DRL-CT	For Non Quick Eject Arbors for Carbide Holesaws
3834-DRL-L	For Non Quick Eject Arbors for Superior Holesaws
3834-DRL-ES	Carbide Tipped for Quick Eject Arbors (ES & ESM) & Carbide Holesaws
3834-DRL-HSS-ES	High Speed Steel for Bi-metal Holesaws
3834-DRL-EL	All Round Carbide Tipped for Quick Eject Arbors & Superior Holesaws

Features

- Pilot drills make a hole in the workpiece before the teeth of the holesaw become engaged, guiding and keeping the holesaw in the correct position during the sawing operation

BAHCO® UPSIZE ADAPTOR

Product Code	Description
3834-UPSIZ	For enlarging existing holes

Features

- Attached to the pilot drill with the hexagon screw
- To be use on both small and large holesaws
- Works excellent with the Quick-Eject arbors

BAHCO® ARBOR ADAPTOR

Product Code	Description
3834-ADP	Fits arbors 630, 730, 930, 1130

Features

- Adapts small arbor threads to accommodate large holesaw threads

BAHCO® CORE EJECTION SPRING

Product Code	Description
3834-ES	For Pilot drills, to facilitate core removal

BAHCO® QUICK EJECT ARBORS

Product Code	Fits Holesaws
3834-ARBR-930ES	Carbide Tipped up to 1 3/16"
3834-ARBR-930EL	Superior up to 1 3/16"
3834-ARBR-930ESM	Bimetal up to 1 3/16"
3834-ARBR-9100ES	Carbide Tipped 1 1/4" and Larger
3834-ARBR-9100EL	Superior 1 1/4" and Larger
3834-ARBR-9100ESM	Bimetal 1 1/4" and Larger

Features

- Allows the user to save time by releasing the core from the holesaw in one simple, fast and efficient operation without burning your fingers on a hot holesaw or release adapter
- Quick eject arbors provides stable drilling in challenging environments
- ESM Arbors include HSS drills, ES & EL Arbors include all round carbide drills

BAHCO® ARBORS

Standard Arbors - Fits holesaw 9/16" to 1-3/16"

Product Code	Dia. (Inch)
3834-ARBR-630	1/4 HEX
3834-ARBR-730	9/32 TRI
3834-ARBR-930	11/32 HEX
3834-ARBR-1130	7/16 HEX

Features

- Includes HSS drill be use for Metal & Wood Applications
- Arbors can be used for Carbide and Multi-Construction holesaw but requires changing the drill

Quick-Change Arbor - Fits holesaw 1-1/4" and bigger

3834-ARBR-9100QC	11/32 HEX
3834-ARBR-11152QC	7/16 HEX
3834-ARBR-16152QC	5/8 HEX

Features

- Arbors have a quick-change mechanism where no additional tools are needed to change the holesaw
- Includes HSS drill be use for Metal & Wood Applications
- Arbors can be used for Carbide and Multi-Construction holesaw but requires changing the drill

Power Driver™ Arbors for Optimal Stability - Fits holesaws 1-1/4" and bigger

3834-ARBR-9100	11/32 HEX
3834-ARBR-11152	7/16 HEX
3834-ARBR-16152	5/8 HEX

Features

- Includes HSS drill be use for Metal & Wood Applications
- Power Driver™ increases the strength and eliminates play of the holesaw by redistributing the load from the thread to the solid cap
- Arbors can be used for Carbide and Multi-Construction holesaw but requires changing the drill

Arbors with SDS+ shank - for Quick Change Chucks

3834-ARBR-SD30	Fits holesaws up to 1-3/16"
3834-ARBR-SD152QC	Fits holesaws up to 1-1/4" and larger

Features

- All arbors are hardened for maximum strength. Pilot drill is included.

BAHCO® ARBOR EXTENSIONS

Product Code	Fits Arbors	Length (Inches)
3834-EXT-1	1130, 11152, 11152QC	12
3834-EXT-2	930, 9100, 9100QC	12

Features

- For reach in difficult to cut surroundings

BAHCO® RECIPROCATING SAW BLADES

FULL OF POWER

BAHCO® has an exceptional range of reciprocating saw blades. Each category has a wide range of shapes, lengths and tothing, with one for every application.

Our Bi-Metal (Sandflex®) blades are famous for their high quality and time-saving performance, and are highly respected by professionals. Our tough carbide tipped blades deliver impressive cutting power in any situation. Whatever the task, you will produce faster, cleaner and more accurate cuts, time after time.



SELECT THE RIGHT TOOTHING (TPI)

TEETH PER INCH

Material thickness	≤ 1/8"	1/8" to 3/8"	3/8" to 3/4"	3/4" to 2"	≥ 2"
Metal Saw Blades	24	18	14 - 10 - 8/12	8/12	
Metal and Wood Saw Blades		10/14	10 - 8/12	6 - 5/8	4/6
Wood Saw Blades		11	7	7 - 5	5
Special Saw Blades		GRIT	6	6	3

SAW BLADE SHAPES

Our range of reciprocating saw blades includes a variety of blade shapes for different styles of cutting.

STANDARD (ST)	SCROLL (SC)	DEMOLITION (DSL)	HIGH SLOPE (HSL)	HEAVY STANDARD (HST)	SLOPE (SL)	PALLET REPAIR (PR)
For fast and aggressive straight cuts, but still flexible for narrow cutting.	For contour sawing and sawing in difficult-to-reach places.	Extra thick and wide saw blades for demolition and heavy-duty work.	The wide body makes it highly resistant to bending, allowing straight cuts in wood.	The wide body makes it highly resistant to bending, allowing straighter cuts.	Thick blades with a narrow nose for sawing in tight spots, but highly resistant to bending.	The rounded front design prevents the blade from getting stuck.





TOOLS FOR THE TRADES

RECIPROCATING SAW BLADES

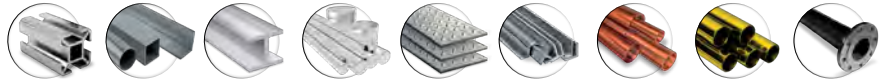
FULL RANGE OF RECIPROCATING SAW BLADES AVAILABLE

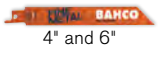

RECIPROCATING
SAW BLADES
FOR METAL



 4"-12"	✓	✓	✓	✓	✓	✓	✓	✓	
 6"-12"	✓	✓	✓	✓	✓	✓			✓
 4" and 6"		✓			✓	✓			
 4"		✓			✓		✓	✓	



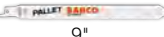

RECIPROCATING
SAW BLADES
FOR WOOD & METAL

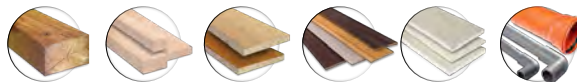

 6"-12"	✓	✓	✓			
 6"-12"	✓		✓	✓		
 9"	✓		✓	✓	✓	✓
 9"	✓	✓				



RECIPROCATING
SAW BLADES
FOR WOOD



 9" and 12"		✓	✓			
 9" and 12"	✓	✓				
 9"			✓	✓		✓
 6"-12"			✓		✓	

RECIPROCATING
SAW BLADES
FOR SPECIAL
APPLICATIONS

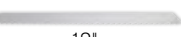

 6"-12"	✓	✓	✓			
 12"				✓		
 4" and 6"					✓	✓

RECIPROCATING SAW BLADES

TOOLS FOR
THE TRADES

BAHCO® RECIPROCATING SAW BLADES FOR METAL



RECIPROCATING SAW BLADES

TOOLS FOR THE TRADES

BAHCO® BI-METAL BLADES FOR CUTTING METAL

Product Code	Blade-length (inch)	Blade-length (mm)	Blade-thickness (inch)	Blade-thickness (mm)	Teeth per inch	Pack QTY
3940-100-14-ST-2P	4	100	0.035	0.9	14	2
3940-100-14-ST-5P	4	100	0.035	0.9	14	5
3940-100-14-ST-10P	4	100	0.035	0.9	14	10
3940-100-18-ST-2P	4	100	0.035	0.9	18	2
3940-100-18-ST-5P	4	100	0.035	0.9	18	5
3940-100-18-ST-10P	4	100	0.035	0.9	18	10
3940-150-14-ST-2P	6	150	0.035	0.9	14	2
3940-150-14-ST-5P	6	150	0.035	0.9	14	5
3940-150-14-ST-10P	6	150	0.035	0.9	14	10
3940-150-14-ST-100P	6	150	0.035	0.9	14	100
3940-150-18-ST-2P	6	150	0.035	0.9	18	2
3940-150-18-ST-5P	6	150	0.035	0.9	18	5
3940-150-18-ST-10P	6	150	0.035	0.9	18	10
3940-150-18-ST-100P	6	150	0.035	0.9	18	100
3940-228-14-ST-2P	9	228	0.035	0.9	14	2
3940-228-14-ST-5P	9	228	0.035	0.9	14	5
3940-228-14-ST-10P	9	228	0.035	0.9	14	10
3940-228-14-ST-100P	9	228	0.035	0.9	14	100
3940-228-18-ST-2P	9	228	0.035	0.9	18	2
3940-228-18-ST-5P	9	228	0.035	0.9	18	5
3940-228-18-ST-10P	9	228	0.035	0.9	18	10
3940-228-18-ST-100P	9	228	0.035	0.9	18	100
3940-300-14-ST-2P	12	300	0.035	0.9	14	2
3940-300-14-ST-5P	12	300	0.035	0.9	14	5
3940-300-14-ST-10P	12	300	0.035	0.9	14	10
3940-300-14-ST-100P	12	300	0.035	0.9	14	100
3940-300-18-ST-2P	12	300	0.035	0.9	18	2
3940-300-18-ST-5P	12	300	0.035	0.9	18	5
3940-300-18-ST-10P	12	300	0.035	0.9	18	10
3940-300-18-ST-100P	12	300	0.035	0.9	18	100

Features

- The metal blade family is designed for demanding metal cutting
- The standard-shaped (ST) blades with high performance and precision-ground teeth
- Standard-shape (ST) for fast and aggressive straight cuts but still flexible for narrow cutting



BAHCO® BI-METAL BLADES FOR METAL PRECISION CUTTING

Product Code	Blade-length (inch)	Blade-length (mm)	Blade-thickness (inch)	Blade-thickness (mm)	Teeth per inch	Pack QTY
3940-100-14-SC-2P	4	100	0.035	0.9	14	2
3940-100-14-SC-5P	4	100	0.035	0.9	14	5
3940-100-18-SC-2P	4	100	0.035	0.9	18	2
3940-100-18-SC-5P	4	100	0.035	0.9	18	5
3940-100-24-SC-2P	4	100	0.035	0.9	24	2
3940-100-24-SC-5P	4	100	0.035	0.9	24	5

Features

- The Precision Metal scroll-shaped blades with high performance and precision-ground teeth
- Scroll (SC) shape for contour sawing and in difficult-to-reach places



BAHCO® BI-METAL BLADES FOR CUTTING HEAVY METAL

Product Code	Blade-length		Blade-thickness		Teeth per inch	Pack QTY
	(inch)	(mm)	(inch)	(mm)		
3940-150-10-ST-2P	6	150	0.035	0.9	10	2
3940-150-10-ST-5P	6	150	0.035	0.9	10	5
3940-150-10-ST-10P	6	150	0.035	0.9	10	10
3940-150-10-ST-100P	6	150	0.035	0.9	10	100
3940-150-8/12-ST-2P	6	150	0.035	0.9	8/12	2
3940-150-8/12-ST-5P	6	150	0.035	0.9	8/12	5
3940-150-8/12-ST-10P	6	150	0.035	0.9	8/12	10
3940-150-8/12-ST-100P	6	150	0.035	0.9	8/12	100
3940-150-10-HST-2P	6	150	0.042	1.07	10	2
3940-150-10-HST-5P	6	150	0.042	1.07	10	5
3940-150-10-HST-10P	6	150	0.042	1.07	10	10
3940-150-14-HST-2P	6	150	0.042	1.07	14	2
3940-150-14-HST-5P	6	150	0.042	1.07	14	5
3940-150-14-HST-10P	6	150	0.042	1.07	14	10
3940-150-18-HST-2P	6	150	0.042	1.07	18	2
3940-150-18-HST-5P	6	150	0.042	1.07	18	5
3940-150-18-HST-10P	6	150	0.042	1.07	18	10
3940-228-10-ST-2P	9	228	0.035	0.9	10	2
3940-228-10-ST-5P	9	228	0.035	0.9	10	5
3940-228-10-ST-10P	9	228	0.035	0.9	10	10
3940-228-10-ST-100P	9	228	0.035	0.9	10	100
3940-228-10-HST-2P	9	228	0.042	1.07	10	2
3940-228-10-HST-5P	9	228	0.042	1.07	10	5
3940-228-10-HST-10P	9	228	0.042	1.07	10	10
3940-228-14-HST-2P	9	228	0.042	1.07	14	2
3940-228-14-HST-5P	9	228	0.042	1.07	14	5
3940-228-14-HST-10P	9	228	0.042	1.07	14	10
3940-228-18-HST-2P	9	228	0.042	1.07	18	2
3940-228-18-HST-5P	9	228	0.042	1.07	18	5
3940-228-18-HST-10P	9	228	0.042	1.07	18	10
3940-228-8/12-ST-2P	9	228	0.050	1.3	8/12	2
3940-228-8/12-ST-5P	9	228	0.050	1.3	8/12	5
3940-228-8/12-ST-10P	9	228	0.050	1.3	8/12	10
3940-228-8/12-ST-100P	9	228	0.050	1.3	8/12	100
3940-300-10-HST-2P	12	300	0.042	1.07	10	2
3940-300-10-HST-5P	12	300	0.042	1.07	10	5
3940-300-10-HST-10P	12	300	0.042	1.07	10	10
3940-300-14-HST-2P	12	300	0.042	1.07	14	2
3940-300-14-HST-5P	12	300	0.042	1.07	14	5
3940-300-14-HST-10P	12	300	0.042	1.07	14	10
3940-300-18-HST-2P	12	300	0.042	1.07	18	2
3940-300-18-HST-5P	12	300	0.042	1.07	18	5
3940-300-18-HST-10P	12	300	0.042	1.07	18	10

BAHCO® BI-METAL BLADES FOR CUTTING FINE METAL

Product Code	Blade-length		Blade-thickness		Teeth per inch	Pack QTY
	(inch)	(mm)	(inch)	(mm)		
3940-100-24-ST-2P	4	100	0.035	0.9	24	2
3940-100-24-ST-5P	4	100	0.035	0.9	24	5
3940-100-24-ST-10P	4	100	0.035	0.9	24	10
3940-150-24-ST-2P	6	150	0.035	0.9	24	2
3940-150-24-ST-5P	6	150	0.035	0.9	24	5
3940-150-24-ST-10P	6	150	0.035	0.9	24	10
3940-150-24-ST-100P	6	150	0.035	0.9	24	100

Features

- The Fine Metal blade family is designed for metal cutting in thin materials
- The standard-shaped (ST) blades with high performance and precision-ground teeth
- Standard-shape (ST) for fast and aggressive straight cuts but still flexible for narrow cutting
- Slope-shaped nose for various types of cuts

Features

- The Heavy Metal blade family is designed for demanding metal cutting in thick materials
- Heavy standard (HST) Bi-Metal blades with precision ground teeth are a series of extra thick blades with a wider body that makes it more rigid and has a higher resistance to fracturing and bending, allowing straighter cuts
- Standard (ST) Bi-Metal blades with coarse precision ground teeth are a series of flexible blades with a standard body that makes it more flexible and easy to bend into position

BAHCO® RECIPROCATING SAW BLADES FOR WOOD & METAL

MADE FOR BOTH THE EMERGENCY SERVICES AND PROFESSIONAL CRAFTSMEN

RECIPROCATING SAW BLADES

Simple saw blade selection thanks to the printed material information

Virtually unbreakable Sandflex® bi-metal blades

Improved blade design based on the application



Specially made for aggressive straight cuts

Long-life teeth (HSS 8% Cobalt)

BAHCO® BI-METAL BLADES FOR CUTTING WOOD AND METAL

Product Code	Blade-length		Blade-thickness		Teeth per inch	Pack QTY
	(inch)	(mm)	(inch)	(mm)		
3940-150-6-ST-2P	6	150	0.035	0.9	6	2
3940-150-6-ST-5P	6	150	0.035	0.9	6	5
3940-150-6-ST-10P	6	150	0.035	0.9	6	10
3940-150-4/6-SC-2P	6	150	0.050	1.3	4/6	2
3940-150-4/6-SC-5P	6	150	0.050	1.3	4/6	5
3940-150-4/6-SC-10P	6	150	0.050	1.3	4/6	10
3940-150-5/8-SL-2P	6	150	0.050	1.3	5/8	2
3940-150-5/8-SL-5P	6	150	0.050	1.3	5/8	5
3940-150-5/8-SL-10P	6	150	0.050	1.3	5/8	10
3940-150-5/8-SL-100P	6	150	0.050	1.3	5/8	100
3940-228-6-SL-2P	9	228	0.050	1.3	6	2
3940-228-6-SL-5P	9	228	0.050	1.3	6	5
3940-228-6-SL-10P	9	228	0.050	1.3	6	10
3940-300-6-SL-2P	12	300	0.050	1.3	6	2
3940-300-6-SL-5P	12	300	0.050	1.3	6	5
3940-300-6-SL-10P	12	300	0.050	1.3	6	10
3940-300-8/12-SL-2P	12	300	0.050	1.3	8/12	2
3940-300-8/12-SL-5P	12	300	0.050	1.3	8/12	5
3940-300-8/12-SL-10P	12	300	0.050	1.3	8/12	10
3940-300-8/12-SL-100P	12	300	0.050	1.3	8/12	100

Features

- The Wood and Metal blade family is designed for demanding cutting in wood, even with embedded nails, but it can also be used for thick metal materials
- Slope-shaped (SL) Bi-Metal blades with precision ground teeth are a series of thicker blades with a narrow nose that makes it accessible in narrow places but still rigid and has a higher resistance to fracturing and bending, allowing straighter cuts
- Standard (ST) Bi-Metal blades with coarse precision ground teeth are a series of flexible blades with standard body that makes it more flexible and easy to bend into position



TOOLS FOR THE TRADES



BAHCO® BI-METAL BLADES FOR FIRE AND RESCUE

Product Code	Blade-length		Blade-thickness		Teeth per inch	Pack QTY
	(inch)	(mm)	(inch)	(mm)		
3940-228-10-DSL-2P	9	228	0.062	1.6	10	2
3940-228-10-DSL-5P	9	228	0.062	1.6	10	5
3940-228-10-DSL-10P	9	228	0.062	1.6	10	10

Features

- The Fire & Rescue bi-metal blade with precision ground teeth is an extra heavy duty blade for metal/demolition applications, to be used in extreme conditions



BAHCO® BI-METAL BLADES FOR DEMOLITION

Product Code	Blade-length		Blade-thickness		Teeth per inch	Pack QTY
	(inch)	(mm)	(inch)	(mm)		
3940-150-5/8-DSL-2P	6	150	0.062	1.6	5/8	2
3940-150-5/8-DSL-5P	6	150	0.062	1.6	5/8	5
3940-150-5/8-DSL-10P	6	150	0.062	1.6	5/8	10
3940-228-5/8-DSL-2P	9	228	0.062	1.6	5/8	2
3940-228-5/8-DSL-5P	9	228	0.062	1.6	5/8	5
3940-228-5/8-DSL-10P	9	228	0.062	1.6	5/8	10
3940-300-5/8-DSL-2P	12	300	0.062	1.6	5/8	2
3940-300-5/8-DSL-5P	12	300	0.062	1.6	5/8	5
3940-300-5/8-DSL-10P	12	300	0.062	1.6	5/8	10

Features

- The Sandflex® Demolition slope (DSL) Bi-Metal blades are a series of extra thick and wide saw blades for demolition and heavy-duty work
- Perfect for nail-embedded wood



BAHCO® BI-METAL BLADES FOR PALLET REPAIR

Product Code	Blade-length		Blade-thickness		Teeth per inch	Pack QTY
	(inch)	(mm)	(inch)	(mm)		
3940-228-10/14-PR09-10P	9	228	0.035	0.9	10/14	10
3940-228-10/14-PR09-100P	9	228	0.035	0.9	10/14	100
3940-228-10/14-PR13-100P	9	228	0.035	0.9	10/14	100
3940-228-8/12-PR13-100P	9	228	0.050	1.3	8/12	100

Features

- The pallet repair blade is developed in close co-operation with pallet repair shops
- The unique front design prevents the blade front from getting stuck in close by wood beams when cutting nails in damaged parts of the pallet
- By increasing the shank radius we have improved the fatigue strength
- 10/14 TPI has proved to be the most popular tothing amongst users in pallet repair shops. This tothing has good material removal rate in wood with nails and high strength to tooth breakage

BAHCO® RECIPROCATING SAW BLADES FOR WOOD & PLASTIC

SPECIAL TOOTHING FOR FAST CROSS-CUTTING AND RIPPING

Simple saw blade selection thanks to the printed material information

Strong high-carbon steel blades

Improved blade design based on the application

Low-friction coating minimises heat generation

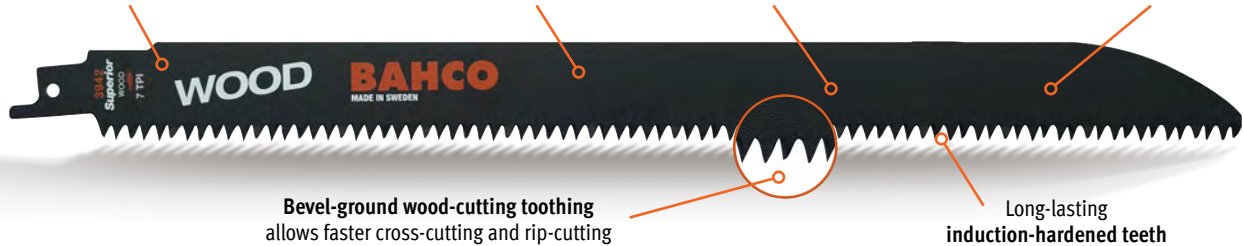

RECIPROCATING SAW BLADES

TOOLS FOR THE TRADES

BAHCO® HIGH CARBON STEEL BLADES FOR CUTTING WOOD

Product Code	Blade-length (inch)	Blade-length (mm)	Blade-thickness (inch)	Blade-thickness (mm)	Teeth per inch	Pack QTY
3942-228-7-HSL-2P	9	228	0.039	1	7	2
3942-228-7-HSL-5P	9	228	0.039	1	7	5
3942-228-7-HSL-10P	9	228	0.039	1	7	10
3942-300-7-HSL-2P	12	300	0.039	1	7	2
3942-300-7-HSL-5P	12	300	0.039	1	7	5
3942-300-7-HSL-10P	12	300	0.039	1	7	10

Features

- Unique bevel-ground teeth provide a quick cut and deliver the best results in wood
- The blade is made of High Carbon Steel and the teeth are induction hardened for a very long life before being coated for minimum friction
- The tothing allows considerably faster cutting compared to traditional blades; 7 for all-round wood cut

BAHCO® HIGH CARBON STEEL BLADES FOR CUTTING COARSE WOOD

Product Code	Blade-length (inch)	Blade-length (mm)	Blade-thickness (inch)	Blade-thickness (mm)	Teeth per inch	Pack QTY
3942-228-5-HSL-2P	9	228	0.039	1	5	2
3942-228-5-HSL-5P	9	228	0.039	1	5	5
3942-228-5-HSL-10P	9	228	0.039	1	5	10
3942-300-5-HSL-2P	12	300	0.039	1	5	2
3942-300-5-HSL-5P	12	300	0.039	1	5	5
3942-300-5-HSL-10P	12	300	0.039	1	5	10

Features

- Unique bevel-ground teeth provide a quick cut and deliver the best results in coarse wood
- The tothing allows considerably faster cutting compared to traditional blades; 5 for coarse and very fast cuts

BAHCO® HIGH CARBON STEEL BLADES FOR CUTTING WOOD & PLASTIC

Product Code	Blade-length (inch)	Blade-length (mm)	Blade-thickness (inch)	Blade-thickness (mm)	Teeth per inch	Pack QTY
3942-228-11-HSL-2P	9	228	0.039	1	11	2
3942-228-11-HSL-5P	9	228	0.039	1	11	5
3942-228-11-HSL-10P	9	228	0.039	1	11	10

Features

- The blade is made of High Carbon Steel and the teeth are induction hardened for a very long life before being coated for minimum friction
- Unique bevel-ground teeth provide a quick cut and deliver the best results in wood and plastic
- The tothing allows considerably faster cutting compared to traditional blades; 11 for fine cut





BAHCO® BI-METAL BLADES FOR CUTTING PLASTER AND BOARDS

Product Code	Blade-length		Blade-thickness		Teeth per inch	Pack QTY
	(inch)	(mm)	(inch)	(mm)		
3942-150-7-SL-2P	6	150	0.043	1.1	7	2
3942-150-7-SL-5P	6	150	0.043	1.1	7	5
3942-150-7-SL-10P	6	150	0.043	1.1	7	10
3942-228-7-SL-2P	9	228	0.043	1.1	7	2
3942-228-7-SL-5P	9	228	0.043	1.1	7	5
3942-228-7-SL-10P	9	228	0.043	1.1	7	10
3942-300-7-SL-2P	12	300	0.043	1.1	7	2
3942-300-7-SL-5P	12	300	0.043	1.1	7	5
3942-300-7-SL-10P	12	300	0.043	1.1	7	10

Features

- The Plaster and Board Bi-Metal blade is designed for demanding cutting in both plaster and different types of wooden chip boards
- Slope (SL) shape for various types of cuts
- The toothing allows considerably faster cutting compared to traditional blades
- The blade is coated for minimum friction

BAHCO® RECIPROCATING SAW BLADES FOR SPECIAL APPLICATIONS

SPECIALIZED BLADES FOR INDUSTRY-SPECIFIC APPLICATIONS



BAHCO® STAINLESS STEEL BLADES FOR CUTTING MEAT AND ICE

Product Code	Blade-length		Blade-thickness		Teeth per inch	Pack QTY
	(inch)	(mm)	(inch)	(mm)		
3944-300-3-MEAT-1P	12	300	0.049	1.25	3	1

Features

- Reciprocating blade made for cutting meat/bone and frozen materials



BAHCO® BI-METAL CAR BODY SAW BLADES

Product Code	Length (inch)	Material Thickness Capacity (Inches)	Teeth per inch	Pack QTY
3845-18-100P - Bulk	3 1/2	Over 0.20	18	100
3845-24-10P	3 1/2	0.08 to 0.20	24	10
3845-24-100P - Bulk	3 1/2	0.08 to 0.20	24	100
3845-32-10P	3 1/2	0 to 0.08	32	10
3845-32-100P - Bulk	3 1/2	0 to 0.08	32	100

- Car-body saw blades for pneumatic or electric reciprocating body shop saws
- Mainly used in automotive body shops
- Bulk packed for heavy usage applications

BAHCO® RECIPROCATING CARBIDE-TIPPED SAW BLADES

BLADES FOR HEAVY-DUTY APPLICATIONS

Simple saw blade selection thanks to the printed material information

Highly-resistant body allows straighter cuts even at heavy-duty work

Improved blade design based on the application



Carbide teeth withstand heat and can work long under extreme conditions

Sharp, long-life teeth carbide technology

BAHCO® CARBIDE TIPPED BLADES FOR WOOD WITH NAIL AND WALL DEMOLITION

Product Code	Blade-length (inch) (mm)		Blade-thickness (inch) (mm)		Teeth per inch	Pack QTY
3946-150-6-DSL-1P	6	150	0.050	1.3	6	1
3946-228-6-DSL-1P	9	228	0.050	1.3	6	1
3946-300-6-DSL-1P	12	300	0.050	1.3	6	1

Features

- Demolition shape extra thick and wide saw blades for demolition and heavy duty work
- Long life with high performance due to the carbide teeth design, making it suitable for work in extreme conditions
- Universal shank - fits any type reciprocating saw
- Carbide tipped blades withstand heat and work long under extreme conditions

BAHCO® CARBIDE TIPPED BLADES FOR DEMANDING METAL CUTTING

Product Code	Blade-length (inch) (mm)		Blade-thickness (inch) (mm)		Teeth per inch	Pack QTY
3946-150-8-HST-1P	6	150	0.050	1.3	8	1
3946-228-8-HST-1P	9	228	0.050	1.3	8	1
3946-300-8-HST-1P	12	300	0.050	1.3	8	1

Features

- Heavy standard shape's wide body makes it highly resistant to bending, allowing straighter cuts even in heavy duty work
- Long life with high performance due to the carbide teeth design, making it suitable for work in extreme conditions
- Universal shank - fits any type reciprocating saw
- Blades are suitable for applications with high-strength steel and for tubes or profiles 5/32 to 1/2" thick

BAHCO® CARBIDE TIPPED BLADES FOR DEMANDING STAINLESS STEEL CUTTING

Product Code	Blade-length (inch) (mm)		Blade-thickness (inch) (mm)		Teeth per inch	Pack QTY
3946-150-10-HST-1P	6	150	0.050	1.3	10	1
3946-228-10-HST-1P	9	228	0.050	1.3	10	1
3946-300-10-HST-1P	12	300	0.050	1.3	10	1

Features

- Heavy standard shape's wide body makes it highly resistant to bending, allowing straighter cuts even in heavy duty work
- Long life with high performance due to the carbide teeth design, making it suitable for work in extreme conditions
- Universal shank - fits any type reciprocating saw
- Blades are suitable for cutting stainless steel and tubes or profiles 3/16 to 3/8" thick

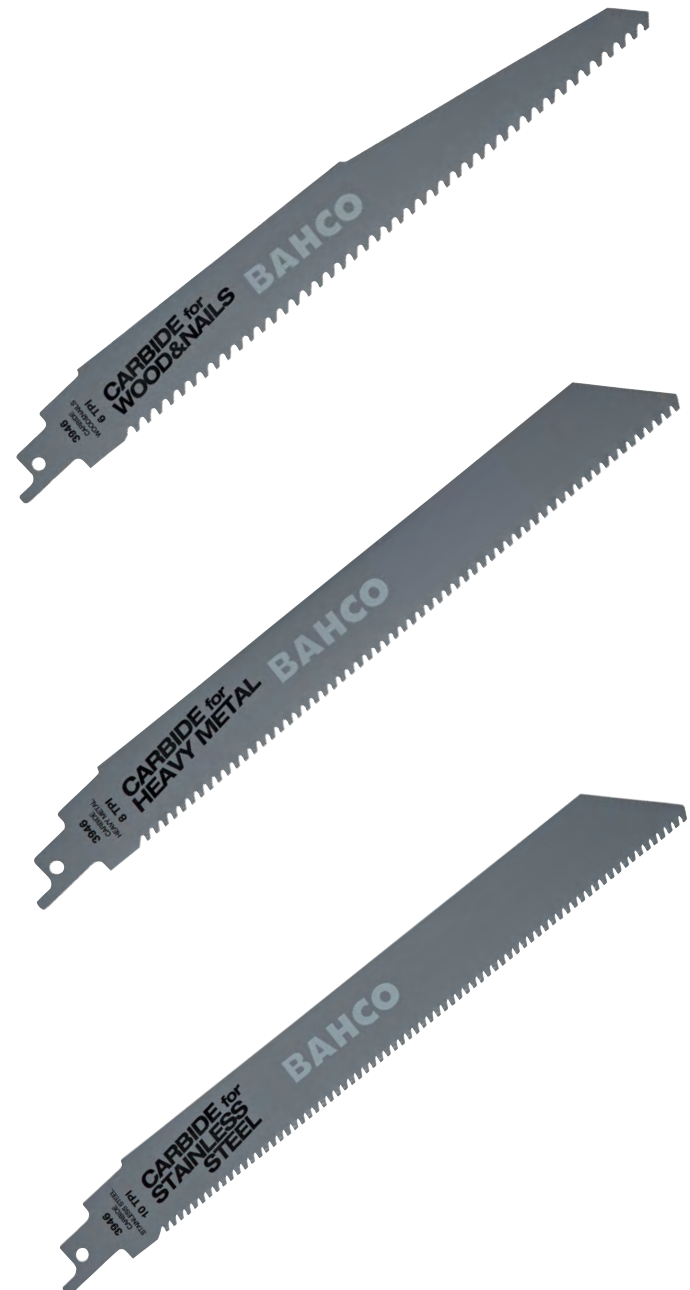

RECIPROCATING SAW BLADES

TOOLS FOR THE TRADES



BAHCO® DIAMOND GRIT BLADES FOR CUTTING WOOD, CAST IRON AND CERAMIC

Product Code	Blade-length		Blade-thickness		Teeth per inch	Pack QTY
	(inch)	(mm)	(inch)	(mm)		
3946-100-DG-ST-2P	4	100	0.050	1.2	Grit	1
3946-150-DG-ST-2P	6	150	0.050	1.2	Grit	1

Features

- Standard Shep for fast and aggressive straight cuts, but still flexible for narrow cutting
- Special design to cut Cement Cast Iron and the only blade that can cut pipes from cemented case iron
- Diamond grit blades withstand heat and can work in extreme conditions
- Universal shank - fits any type reciprocating saw



BAHCO® CARBIDE GRIT BLADES FOR CUTTING TILE AND GLASS

Product Code	Blade-length		Blade-thickness		Teeth per inch	Pack QTY
	(inch)	(mm)	(inch)	(mm)		
3946-100-G-ST-2P	4	100	0.035	0.9	Grit	2
3946-150-G-ST-2P	6	150	0.035	0.9	Grit	2

Features

- Carbide Grit for cutting hard materials such as tiles, ceramics and glass Shape Standard (ST)



BAHCO® CARBIDE TIPPED BLADES FOR DEMANDING BRICK CUTTING

Product Code	Blade-length		Blade-thickness		Teeth per inch	Pack QTY
	(inch)	(mm)	(inch)	(mm)		
3946-300-2-CB-1P	6	300	0.06	1.5	CB	1
3946-457-2-CB-1P	18	457	0.06	1.5	CB	1

Features

- Special blade design with an extra wide body that makes it highly resistant to bending, allowing straight cuts
- Designed for cutting through the roughest abrasive materials such as bricks, LECA and aerated concrete
- Universal shank - fits any type reciprocating saw



BAHCO® CARBIDE TIPPED BLADES FOR CUTTING STONE MATERIALS

Product Code	Blade-length		Blade-thickness		Teeth per inch	Pack QTY
	(inch)	(mm)	(inch)	(mm)		
3946-150-6-SL-1P	6	150	0.035	0.9	6	1
3946-228-3-ST-1P	9	228	0.035	0.9	3	1
3946-228-6-ST-1P	9	228	0.050	1.3	6	1
3946-300-3-ST-1P	12	300	0.060	1.5	3	1
3946-300-6-ST-1P	12	300	0.050	1.3	6	1

Features

- A new wide range of 3 and 6 TPI carbide tipped blades for cutting of non-ferrous materials such as lightweight concrete, bricks, fiberglass
- Comes in two shapes, Slope (SL) shape for various types of cuts and Standard (ST) shape for fast and aggressive straight cuts
- Universal shank - fits any type reciprocating saw

BAHCO® 7 PIECE SOFT GRIP PUNCH AND CHISEL SET

Soft Grip

Product Code	Description
3654BMS/7	7 Piece Soft Grip Punch and Chisel Set

Contents Include:

Description	Point Diameter	Description	Point Diameter
Pin Punch	1/16	Chisels	5/8
Pin Punch	1/8	Chisels	3/4
Pin Punch	3/16	Center	1/4
Pin Punch	1/4		

BAHCO® 7 PIECE SOFT GRIP PIN PUNCH SET

Soft Grip

Product Code	Description
3734BMS/7	7 Piece Soft Grip Pin Punch Set

Contents Include:

Description	Point Diameter	Description	Point Diameter
Pin Punch	1/16	Pin Punch	1/4
Pin Punch	1/8	Pin Punch	5/16
Pin Punch	3/16	Pin Punch	3/8
Pin Punch	3/8		

Features

- Soft grip handle provides a powerful grip, is more comfortable in cold work environments and reduces strike vibration
- Semispherical striking area controls mushrooming to help reduce chipping and splitting
- Cutting edges on chisels are hand ground to consistently produce a quality edge
- Black oxide coated
- Manufactured from special alloy steel that is differentially heat treated to increase durability

BAHCO® POINTED CHISELS

Safety impact head

Product Code	Length (Inches)
3739H-250	10
3739H-300	12
3739H-400	15 1/2

Features

- Safety impact head with plastic hand protection

BAHCO® SLITTING CHISEL

Safety impact head

Product Code	Length (Inches)
3750H	10

Features

- Safety impact head with plastic hand protection

BAHCO® MASON'S CHISEL

Safety impact head

Product Code	Length (Inches)	Tip Width (Inches)
3736MH-250	10"	1"
3736MH-300	12	1"
3736MH-400	15 1/2	1"

Features

- Safety impact head with plastic hand protection



3654BMS/7



3734BMS/7



3739H



3750H



3736MH



1-476-04-3-2

BAHCO® ERGO™ 6 PIECE ENGINEERING FILE SET

With Bi-Molded ERGO™ Handle

Product Code	Description
1-476-04-3-2	6 Piece Engineering File Set

Contents Include:

Description	Length (Inch)	Type of Cut
Hand Smooth	4	Smooth
Warding Smooth	4	Smooth
Square Smooth	4	Smooth
Three Square Smooth	4	Smooth
Half Round Smooth	4	Smooth
Round Smooth	4	Smooth

Features

- Files are smooth, double cut and designed for the fine filing and polishing applications
- Supplied with pouch



1-478-08-1-2

BAHCO® ERGO™ 5 PIECE ENGINEERING FILE SET

With Bi-Molded ERGO™ Handle

Product Code	Description
1-478-08-1-2	5 Piece Engineering File Set

Contents Include:

Description	Length (Inch)	Type of Cut
Hand Bastard	8	Bastard
Hand Second	8	Second
Square Bastard	8	Bastard
Half Round Bastard	8	Bastard
Round Bastard	8	Bastard

Features

- Files are coarse, double cut and designed for high removal rate
- Supplied with pouch



1-473-06-2-2

BAHCO® ERGO™ 3 PIECE ENGINEERING FILE SET

With Bi-Molded ERGO™ Handle

Product Code	Description
1-473-06-2-2	3 Piece Engineering File Set

Contents Include:

Description	Length (Inch)	Type of Cut
Hand Second	8	Second
Half Round Second	8	Second
Round Second	8	Second

Features

- Files are medium coarse, double cut and designed for high removal rate
- Supplied with pouch

BAHCO® NEEDLE FILE SETS

Product Code	# of Pieces	Length (Inch)	Teeth Per Inch (TPI)	Type of Cut
2-472-14-2-0	12	5 ½	97	Smooth
2-472-16-0-0	12	6 ¼	64	Bastard
2-472-16-1-0	12	6 ¼	79	Second
2-472-16-2-0	12	6 ¼	97	Smooth
2-471-16-1-0	9	6 ¼	79	Second
2-470-14-2-0	6	5 ½	97	Smooth
2-470-14-4-0	6	5 ½	142	Dead Smooth
2-470-16-1-0	6	6 ¼	79	Second

Features

- Files in snap shut plastic wallet with hanging hole
- Includes one handle 9-488-02-10
- 12 Piece contains one file each of: hand, flat, three square, square, half round, crossing, round, knife, barrette, slitting, round-edge joint and marking
- 9 Piece contains one file each of: hand, flat, half round, round, three square, square, oval, crossing, knife
- 6 Piece contains one file each of: hand, flat, half round, round, three square and square

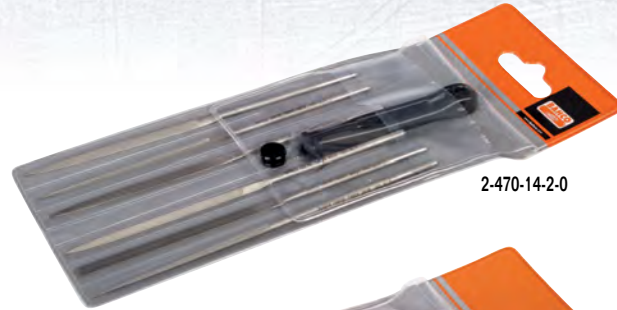

2-470-14-2-0



2-471-16-1-0



2-472-14-2-0

BAHCO® ERGO™ HOMEOWNER'S FILE SET

With Bi-Molded ERGO™ Handle

Product Code	Length (Inch)	Width (Inch)	Height (Inch)	Type of Cut
4-154-08-2-2	8	1	5/32	Bastard + Second

Features

- Set contains one 4-152 Homeowner's file for wood and one 4-153 Homeowner's file for metal



4-154-08-2-2



1-100-10-1-2

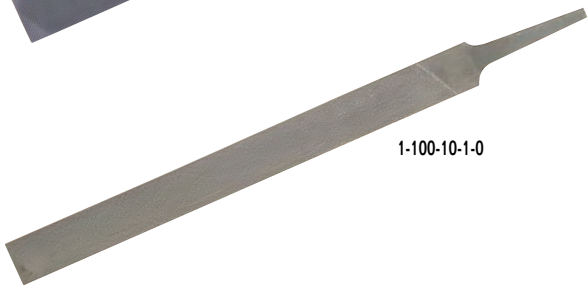

1-100-10-1-0

BAHCO® ERGO™ MILL FILE (USA TYPE)- TWO FLAT EDGES

Hand File

Product Code	Length (Inch)	Width (Inch)	Height (Inch)	Teeth Per Inch (TPI)	Type of Cut
--------------	---------------	--------------	---------------	----------------------	-------------

With Bi-Molded ERGO™ Handle

1-100-06-1-2	6	5/8	5/32	30	Bastard
1-100-06-2-2	6	5/8	5/32	43	Second
1-100-08-1-2	8	25/32	13/64	25	Bastard
1-100-10-1-2	10	1	7/32	23	Bastard
1-100-10-2-2	10	1	7/32	30	Second

Without handle

1-100-04-1-0	4	19/32	1/8	38	Bastard
1-100-04-2-0	4	15/32	1/8	53	Second
1-100-04-3-0	4	19/32	1/8	74	Smooth
1-100-06-1-0	6	5/8	5/32	30	Bastard
1-100-06-2-0	6	5/8	5/32	43	Second
1-100-06-3-0	6	5/8	5/32	61	Smooth
1-100-08-1-0	8	25/32	13/64	25	Bastard
1-100-08-2-0	8	25/32	13/64	38	Second
1-100-08-3-0	8	25/32	13/64	53	Smooth
1-100-10-1-0	10	1	7/32	23	Bastard
1-100-10-2-0	10	1	7/32	30	Second
1-100-10-3-0	10	1	7/32	45	Smooth
1-100-12-1-0	12	1 3/16	5/64	18	Bastard
1-100-12-2-0	12	1 3/16	5/64	25	Second
1-100-12-3-0	12	1 3/16	5/64	38	Smooth
1-100-14-1-0	14	1 3/8	15/64	15	Bastard
1-100-14-2-0	14	1 3/8	15/64	23	Second
1-100-14-3-0	14	1 3/8	15/64	30	Smooth

Features

- For filing flat surfaces, sharp corners and shoulders as well as for deburring
- To work in high-alloy tool steels, for sharpening of heavy implements
- File surfaces are double cut while the edges have one side single cut and one side uncut

BAHCO® LATHE FILE

Engineering File

Product Code	Length (Inch)	Width (Inch)	Height (Inch)	Teeth Per Inch (TPI)	Type of Cut
1-104-10-2-0	10	31/32	7/32	30	Second
1-104-10-3-0	10	31/32	7/32	43	Smooth
1-104-12-2-0	12	15/32	1 1/64	25	Second
1-104-12-3-0	12	15/32	15/64	36	Smooth
1-104-14-3-0	14	1 3/8	15/64	30	Smooth

Features

- For polishing and deburring work in lathes
- Releases chips easily and produces smooth surfaces
- File surface is single cut while edges are uncut

BAHCO® ERGO™ HAND FILE

Engineering File

Product Code	Length (Inch)	Width (Inch)	Height (Inch)	Teeth Per Inch (TPI)	Type of Cut
--------------	---------------	--------------	---------------	----------------------	-------------

With Bi-Molded ERGO™ Handle

1-106-08-1-2	8	25/32	13/64	25	Bastard
1-106-10-1-2	10	31/32	13/64	23	Bastard

Without handle

1-106-08-1-0	8	25/32	13/64	25	Bastard
1-106-10-1-0	10	31/32	13/64	23	Bastard
1-106-12-1-0	12	3/16	13/16	18	Bastard

Features

- For polishing and deburring work in lathes
- Releases chips easily and produces smooth surfaces
- File surface is oberg cut while the edges have one side single cut and one side uncut

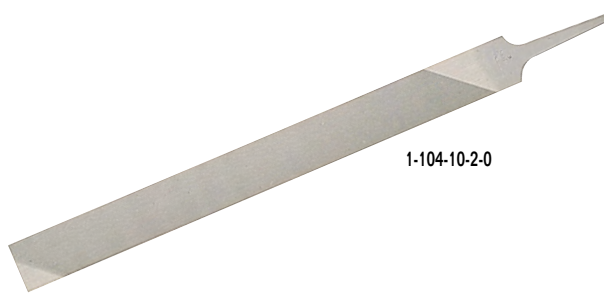

1-104-10-2-0



1-106-08-1-2

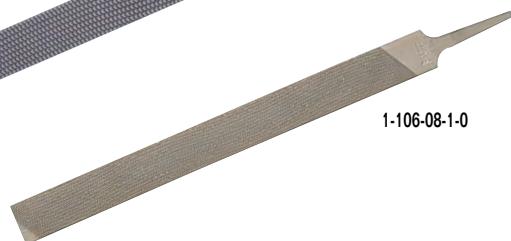

1-106-08-1-0

BAHCO® ERGO™ FLAT FILE

Engineering File

Product Code	Length (Inch)	Width (Inch)	Height (Inch)	Teeth Per Inch (TPI)	Type of Cut
--------------	---------------	--------------	---------------	----------------------	-------------

With Bi-Molded ERGO™ Handle

1-110-08-1-2	8	25/32	13/64	25	Bastard
1-110-08-2-2	8	25/32	13/64	38	Second
1-110-10-1-2	10	1	7/32	23	Bastard
1-110-10-2-2	10	1	7/32	30	Second
1-110-10-3-2	10	1	7/32	43	Smooth

Without handle

1-110-04-1-0	4	15/32	1/8	38	Bastard
1-110-04-2-0	4	15/32	1/8	53	Second
1-110-04-3-0	4	15/32	1/8	74	Smooth
1-110-06-1-0	6	5/8	5/32	30	Bastard
1-110-06-2-0	6	5/8	5/32	43	Second
1-110-06-3-0	6	5/8	5/32	61	Smooth
1-110-08-1-0	8	25/32	13/64	25	Bastard
1-110-08-2-0	8	25/32	13/64	38	Second
1-110-08-3-0	8	25/32	13/64	53	Smooth
1-110-10-1-0	10	1	7/32	23	Bastard
1-110-10-2-0	10	1	7/32	30	Second
1-110-10-3-0	10	1	7/32	43	Smooth
1-110-12-1-0	12	1 3/16	15/64	18	Bastard
1-110-12-2-0	12	1 3/16	15/64	25	Second
1-110-12-3-0	12	1 3/16	15/64	38	Smooth
1-110-14-1-0	14	1 3/8	15/64	38	Bastard

Features

- Pointed shape enables user to reach into angles and corners
- Edges are tapered towards the point with surfaces being parallel
- File surfaces is double cut while the edges are single cut



1-110-08-1-2

1-110-08-1-0

BAHCO® WARDING FILE

Engineering File

Product Code	Length (Inch)	Width (Inch)	Height (Inch)	Teeth Per Inch (TPI)	Type of Cut
--------------	---------------	--------------	---------------	----------------------	-------------

Without handle

1-111-04-1-0	4	25/64	3/64	43	Bastard
1-111-04-2-0	4	25/64	3/64	53	Second
1-111-04-3-0	4	25/64	3/64	74	Smooth
1-111-06-1-0	6	19/32	5/64	38	Bastard
1-111-06-2-0	6	19/32	5/64	43	Second
1-111-06-3-0	6	19/32	5/64	61	Smooth
1-111-08-1-0	8	3/4	3/32	30	Bastard
1-111-08-2-0	8	3/4	3/32	38	Second
1-111-08-3-0	8	3/4	3/32	53	Smooth

Features

- Designed for filing narrow grooves, and passages such as filing cuts on keys
- Edges are tapered towards the point with surfaces being parallel
- File surfaces is double cut while the edges are single cut



1-111-08-1-0

BAHCO® ERGO™ MILL FILE (USA TYPE)- TWO FLAT EDGES

Engineering File

Product Code	Length (Inch)	Width (Inch)	Height (Inch)	Teeth Per Inch (TPI)	Type of Cut
With Bi-Molded ERGO™ Handle					
1-143-06-1-2	6	5/8	7/64	48	Bastard
1-143-06-2-2	6	5/8	7/64	53	Second
1-143-08-1-2	8	25/32	1/8	44	Bastard
1-143-10-1-2	10	1	1 3/64	40	Bastard
1-143-10-2-2	10	1	5/32	44	Second

Without handle

1-143-04-1-0	4	7/16	5/64	53	Bastard
1-143-04-2-0	4	7/16	5/64	62	Second
1-143-04-3-0	4	7/16	5/64	75	Smooth
1-143-06-1-0	6	5/8	7/64	48	Bastard
1-143-06-2-0	6	5/8	7/64	53	Second
1-143-06-3-0	6	5/8	7/64	62	Smooth
1-143-08-1-0	8	25/32	1/8	44	Bastard
1-143-08-2-0	8	25/32	1/8	48	Second
1-143-08-3-0	8	25/32	1/8	57	Smooth
1-143-10-1-0	10	1	5/32	40	Bastard
1-143-10-2-0	10	1	5/32	44	Second
1-143-10-3-0	10	1	5/32	53	Smooth
1-143-12-1-0	12	1 13/16	3/16	37	Bastard
1-143-12-2-0	12	1 13/16	3/16	40	Second
1-143-12-3-0	12	1 13/16	3/16	48	Smooth

Features

- Surfaces and edges are single cut
- Suitable for engineering and sharpening file applications
- Can be used for polishing and deburring work in lathes
- Widely used for sharpening tools and implements such as spades, shovels, hoes, scrapers, etc.



1-143-10-1-2

1-143-10-1-0



1-145-12-0-0

BAHCO® PLASTIC CUT FILE

Engineering File

Product Code	Length (Inch)	Width (Inch)	Height (Inch)	Teeth Per Inch (TPI)	Type of Cut
Without handle					
1-145-12-0-0	12	31/32	19/64	39	Smooth
1-145-14-0-0	14	1 1/64	3/16	23	Second

Features

- Designed for fast and easy cutting on plastic laminates
- Excellent for edge finishing
- Single cut

BAHCO® ERGO™ SQUARE FILE

Engineering File

Product Code	Length (Inch)	Width (Inch)	Height (Inch)	Teeth Per Inch (TPI)	Type of Cut
--------------	---------------	--------------	---------------	----------------------	-------------

With Bi-Molded ERGO™ Handle

1-160-06-1-2	6	15/32	15/64	33	Bastard
1-160-06-2-2	6	15/32	15/64	46	Second
1-160-08-1-2	8	5/16	5/16	25	Bastard
1-160-08-2-2	8	5/16	5/16	36	Second
1-160-10-1-2	10	25/64	23/64	23	Bastard

Without handle

1-160-04-1-0	4	11/64	11/64	43	Bastard
1-160-04-2-0	4	11/64	11/64	56	Second
1-160-04-3-0	4	11/64	11/64	71	Smooth
1-160-06-1-0	6	15/32	15/64	33	Bastard
1-160-06-2-0	6	15/32	15/64	46	Second
1-160-06-3-0	6	15/32	15/64	56	Smooth
1-160-08-1-0	8	5/16	5/16	25	Bastard
1-160-08-2-0	8	5/16	5/16	36	Second
1-160-08-3-0	8	5/16	5/16	46	Smooth
1-160-10-1-0	10	25/64	23/64	23	Bastard
1-160-10-2-0	10	25/64	23/64	30	Second
1-160-10-3-0	10	25/64	23/64	41	Smooth
1-160-12-1-0	12	15/32	15/32	20	Bastard
1-160-12-2-0	12	15/32	15/32	28	Second

Features

- Designed for filing grooves, rectangular holes, inside corners and for fine-adjustments of cutting tools
- Surfaces are tapered towards the point and has a double cut



1-160-10-1-2

1-160-10-1-0

BAHCO® ERGO™ THREE SQUARE FILE

Engineering File

Product Code	Length (Inch)	Width (Inch)	Height (Inch)	Teeth Per Inch (TPI)	Type of Cut
--------------	---------------	--------------	---------------	----------------------	-------------

With Bi-Molded ERGO™ Handle

1-170-06-1-2	6	7/16	7/16	33	Bastard
1-170-06-2-2	6	7/16	7/16	46	Second
1-170-08-1-2	8	5/8	5/8	25	Bastard
1-170-08-2-2	8	5/8	5/8	36	Second
1-170-10-1-2	10	11/16	11/16	23	Bastard
1-170-10-3-2	10	11/16	11/16	41	Smooth

Without handle

1-170-04-3-0	4	1/4	1/4	71	Smooth
1-170-06-1-0	6	7/16	7/16	33	Bastard
1-170-06-2-0	6	7/16	7/16	46	Second
1-170-06-3-0	6	7/16	7/16	56	Smooth
1-170-08-1-0	8	5/8	5/8	25	Bastard
1-170-08-2-0	8	5/8	5/8	36	Second
1-170-08-3-0	8	5/8	5/8	46	Smooth
1-170-10-1-0	10	11/16	11/16	23	Bastard
1-170-10-2-0	10	11/16	11/16	30	Second
1-170-10-3-0	10	11/16	11/16	41	Smooth

Features

- Ideal for deburring and filing angles and inner corners. Can be used for filing of holes, large fillets and concave surfaces
- Shaped in an equilateral triangle that tapers towards the point and has double surface cuts



1-170-10-1-2

1-170-10-1-0



BAHCO® ERGO™ HALF-ROUND FILE

Engineering File

Product Code	Length (Inch)	Width (Inch)	Height (Inch)	Teeth Per Inch (TPI)	Type of Cut
With Bi-Molded ERGO™ Handle					
1-210-06-1-2	6	5/8	3/16	33	Bastard
1-210-06-2-2	6	5/8	5/8	46	Second
1-210-06-3-2	6	5/8	5/8	56	Smooth
1-210-08-1-2	8	13/16	13/16	25	Bastard
1-210-08-2-2	8	13/16	13/16	36	Second
1-210-10-1-2	10	1 3/64	1 3/64	23	Bastard
1-210-10-2-2	10	1 3/64	1 3/64	30	Second
1-210-12-1-2	12	1 7/32	1 7/32	20	Bastard
1-210-12-2-2	12	1 7/32	1 7/32	28	Second

Without handle

1-210-04-1-0	4	25/64	1/8	43	Bastard
1-210-04-2-0	4	25/64	1/8	56	Second
1-210-04-3-0	4	25/64	1/8	71	Smooth
1-210-06-1-0	6	5/8	3/16	33	Bastard
1-210-06-2-0	6	5/8	5/8	46	Second
1-210-06-3-0	6	5/8	5/8	56	Smooth
1-210-08-1-0	8	13/16	13/16	25	Bastard
1-210-08-2-0	8	13/16	13/16	36	Second
1-210-08-3-0	8	13/16	13/16	46	Smooth
1-210-10-1-0	10	1 3/64	1 3/64	23	Bastard
1-210-10-2-0	10	1 3/64	1 3/64	30	Second
1-210-10-3-0	10	1 3/64	1 3/64	41	Smooth
1-210-12-1-0	12	1 7/32	1 7/32	20	Bastard
1-210-12-2-0	12	1 7/32	1 7/32	28	Second
1-210-12-3-0	12	1 7/32	1 7/32	36	Smooth
1-210-14-1-0	14	1 3/8	1 3/8	18	Bastard

Features

- Used for filing concave and flat surfaces as well as large holes and deburring requirements
- Edges and surfaces are tapered towards the point and has double surface cuts



BAHCO® ERGO™ ROUND FILE

Engineering File

Product Code	Length (Inch)	Width (Inch)	Height (Inch)	Teeth Per Inch (TPI)	Type of Cut
With Bi-Molded ERGO™ Handle					
1-230-06-1-2	6	15/32	-	33	Bastard
1-230-06-2-2	6	15/32	-	46	Second
1-230-08-1-2	8	5/16	-	25	Bastard
1-230-08-2-2	8	5/16	-	36	Second
1-230-10-1-2	10	25/64	-	23	Bastard
1-230-10-2-2	10	25/64	-	30	Second
1-230-10-3-2	10	25/64	-	41	Smooth

Without handle

1-230-04-1-0	4	9/64	-	43	Bastard
1-230-04-2-0	4	9/64	-	56	Second
1-230-04-3-0	4	9/64	-	71	Smooth
1-230-06-1-0	6	15/32	-	33	Bastard
1-230-06-2-0	6	15/32	-	46	Second
1-230-06-3-0	6	15/32	-	56	Smooth
1-230-08-1-0	8	5/16	-	25	Bastard
1-230-08-2-0	8	5/16	-	36	Second
1-230-08-3-0	8	5/16	-	46	Smooth
1-230-10-1-0	10	25/64	-	23	Bastard
1-230-10-2-0	10	25/64	-	30	Second
1-230-10-3-0	10	25/64	-	41	Smooth
1-230-12-1-0	12	15/32	-	20	Bastard
1-230-12-2-0	12	15/32	-	28	Second
1-230-12-3-0	12	15/32	-	36	Smooth

Features

- Regularly used for filing holes, large fillets and concave surfaces
File is tapered to a point and has a double cut

BAHCO® HAND NEEDLE FILES

Product Code	Length (Inch)	Teeth Per Inch (TPI)	Type of Cut
Without handle			
2-300-14-0-0	5 ½	56	Bastard
2-300-14-2-0	5 ½	86	Smooth
2-300-14-4-0	5 ½	122	Dead Smooth
2-300-16-0-0	6 ¼	56	Bastard
2-300-16-1-0	6 ¼	66	Second
2-300-16-2-0	6 ¼	86	Smooth
2-300-16-4-0	6 ¼	122	Dead Smooth
2-300-18-0-0	7	56	Bastard
2-300-18-2-0	7	86	Smooth

Features

- Perfect for fine filing and polishing jobs
- Used by engravers, precision engineers, instrument makers, watchmakers and goldsmiths
- Edges and surfaces are parallel
- Surfaces double cut, edges single cut

BAHCO® FLAT NEEDLE FILES

Product Code	Length (Inch)	Teeth Per Inch (TPI)	Type of Cut
Without handle			
2-301-14-0-0	5 ½	56	Bastard
2-301-14-2-0	5 ½	86	Smooth
2-301-14-4-0	5 ½	122	Dead Smooth
2-301-16-0-0	6 ¼	56	Bastard
2-301-16-1-0	6 ¼	66	Second
2-301-16-2-0	6 ¼	86	Smooth
2-301-16-4-0	6 ¼	122	Dead Smooth
2-301-18-2-0	7	86	Smooth

Features

- Perfect for fine filing and polishing jobs
- Used by engravers, precision engineers, instrument makers, watchmakers and goldsmiths
- Surfaces parallel, edges taper to a point
- Surfaces double cut, edges single cut

BAHCO® THREE SQUARE NEEDLE FILES

Product Code	Length (Inch)	Teeth Per Inch (TPI)	Type of Cut
Without handle			
2-302-14-0-0	5 ½	56	Bastard
2-302-14-2-0	5 ½	86	Smooth
2-302-14-4-0	5 ½	102	Dead Smooth
2-302-16-0-0	6 ¼	56	Bastard
2-302-16-1-0	6 ¼	66	Second
2-302-16-2-0	6 ¼	86	Smooth
2-302-16-4-0	6 ¼	122	Dead Smooth
2-302-18-0-0	7	56	Bastard
2-302-18-2-0	7	86	Smooth

Features

- Perfect for fine filing and polishing jobs. Used by engravers, precision engineers, instrument makers, watchmakers and goldsmiths
- Triangular, surfaces taper to a point
- Surfaces double cut



2-300-14-0-0



2-301-14-0-0



2-302-14-0-0



BAHCO® SQUARE NEEDLE FILES

Product Code	Length (Inch)	Teeth Per Inch (TPI)	Type of Cut
Without handle			
2-303-14-2-0	5 ½	86	Smooth
2-303-14-4-0	5 ½	122	Dead Smooth
2-303-16-0-0	6 ¼	56	Bastard
2-303-16-1-0	6 ¼	66	Second
2-303-16-2-0	6 ¼	86	Smooth
2-303-16-4-0	6 ¼	122	Dead Smooth
2-303-18-0-0	7	56	Bastard
2-303-18-2-0	7	86	Smooth

Features

- Perfect for fine filing and polishing jobs. Used by engravers, precision engineers, instrument makers, watchmakers and goldsmiths
- Square shape, surface tapered to a point. Surfaces double cut

BAHCO® HALF ROUND NEEDLE FILES

Product Code	Length (Inch)	Teeth Per Inch (TPI)	Type of Cut
Without handle			
2-304-14-0-0	5 ½	56	Bastard
2-304-14-2-0	5 ½	86	Smooth
2-304-14-4-0	5 ½	122	Dead Smooth
2-304-16-0-0	6 ¼	56	Bastard
2-304-16-1-0	6 ¼	66	Second
2-304-16-2-0	6 ¼	86	Smooth
2-304-16-4-0	6 ¼	122	Dead Smooth
2-304-18-0-0	7	56	Bastard
2-304-18-2-0	7	86	Smooth

Features

- Perfect for fine filing and polishing jobs. Used by engravers, precision engineers, instrument makers, watchmakers and goldsmiths
- Surfaces taper to a point. Flat and convex surfaces double cut

BAHCO® MILL SAW FILE

Engineering Files

Product Code	Length (Inch)	Width (Inch)	Height (Inch)	Teeth Per Inch (TPI)	Type of Cut
Without handle - One Round Edges					
4-138-08-1-0	8	²⁹ / ₃₂	¹ / ₈	46	Bastard
4-138-10-1-0	10	1	³ / ₃₂	41	Bastard
4-138-12-1-0	12	1 ¹³ / ₁₆	³ / ₁₆	36	Bastard
Without handle - Two Round Edges					
4-140-06-1-0	6	⁵ / ₈	⁷ / ₆₄	46	Bastard
4-140-08-1-0	8	²⁹ / ₃₂	¹ / ₈	41	Bastard
4-140-10-1-0	10	1	³ / ₃₂	36	Bastard

Features

- Designed for circular, felling and gang saws with fine tothing, including bandsaws
- Excels at draw and fine filing, polishing and deburring work
- Used in the engineering industry as a lathe and deburring file
- File is parallel and thin with surface and edge having single cut and one round edge

BAHCO® FLAT CHISEL BIT FILE

Engineering File

Product Code	Length (Inch)	Width (Inch)	Height (Inch)
4-150-07-3-0	7	¹ / ₂	¹ / ₈

Features

- Designed for filing of square ground cutters
- File is flat

BAHCO® ERGO™ HOMEOWNER'S FILE - FOR WOOD OR METAL

With Bi-Molded ERGO™ Handle

Product Code	Length (Inch)	Teeth Per Inch (TPI)	Type of Cut	Type
4-152-08-2-2	8	41 + 36	Bastard Rasp & Double Second	Wood
4-153-08-1-2	8	25 + 41	Bastard Double & Single Second	Metal

Features

- Wood file has both rasp and double cut
- Wood file is flat and parallel with two flat, uncut edges - one side bastard rasp cut and the other side double second cut
- Metal file has both bastard double and single second cut
- Metal file is flat and parallel with two flat, uncut edges

BAHCO® FARMER'S DOUBLE DUTY FILE

Handle has a hole for hanging.

Product Code	Length (Inch)	Width (Inch)	Height (Inch)	Teeth Per Inch (TPI)	Type of Cut
4-155-08-2-0	8	1	5/32	23	Second
4-155-10-2-0	10	1 13/16	7/32	18	Second

Features

- File is both double and single cut
- Double cut is for filing flat surfaces and for rough sharpening of edges on spades, hoes, etc.
- Single cut is for fine filing of flat surfaces and for fine sharpening of tools and implements
- File has parallel edges with one being uncut - one side is double cut bastard and the other side is single cut bastard

BAHCO® ERGO™ SHARPENING FILES - TAPER SAW FILE

Sharpening File

Product Code	Length (Inch)	Width (Inch)	Height (Inch)	Teeth Per Inch (TPI)	Type of Cut
--------------	---------------	--------------	---------------	----------------------	-------------

With Bi-Molded ERGO™ Handle

4-183-04-2-2	4	2 1/4	-	50	Second
4-183-05-2-2	5	3 1/2	-	46	Second
4-183-06-2-2	6	5 1/2	-	43	Second

Without handle

4-183-06-2-0	6	5 1/2	-	43	Second
4-183-07-2-0	7	7 1/2	-	41	Second
4-183-08-2-0	8	9 1/2	-	41	Second
4-183-10-2-0	10	11 1/2	-	38	Second

Features

- Designed for sharpening saws with cross tothing and teeth at 60° angle
- File is triangular with edges tapering towards the point with surface and edges single cut



4-152-08-2-2



4-155-10-2-0



4-183-04-2-2



4-183-06-2-0



BAHCO® ERGO™ SLIM TAPER FILE

Sharpening File

Product Code	Length (Inch)	Width (Inch)	Height (Inch)	Teeth Per Inch (TPI)	Type of Cut
--------------	---------------	--------------	---------------	----------------------	-------------

With Bi-Molded ERGO™ Handle

4-186-04-2-2	4	9/64	-	58	Second
4-186-05-2-2	5	3/16	-	54	Second
4-186-06-2-2	6	15/64	-	50	Second

Without Handle

4-186-04-2-0	4	9/64	-	58	Second
4-186-05-2-0	5	3/16	-	54	Second
4-186-06-2-0	6	15/64	-	50	Second
4-186-07-2-0	7	17/64	-	46	Second
4-186-08-2-0	8	21/64	-	42	Second

Features

- Used for sharpening of all types of saws with fine cross tothing
- File is triangular with edges tapering towards the point with surface and edges single cut

BAHCO® ERGO™ EXTRA SLIM TAPER FILE

Sharpening File

Product Code	Length (Inch)	Width (Inch)	Teeth Per Inch (TPI)	Type of Cut
--------------	---------------	--------------	----------------------	-------------

With Bi-Molded ERGO™ Handle

4-187-06-2-2	6	3/16	54	Second
--------------	---	------	----	--------

Without Handle

4-187-04-2-0	4	9/64	64	Second
4-187-06-2-0	6	3/16	54	Second
4-187-07-2-0	7	15/64	50	Second
4-287-06-2-0	6	13/64	54	Second

Features

- Used for sharpening of all types of saws with fine cross tothing
- File is triangular with edges tapering towards the point
- Surfaces are single cut on 4-187 and double cut on 4-287
- Edges are single cut
- Section figures indicate the largest width of the file section

BAHCO® DOUBLE EXTRA SLIM TAPER

Sharpening File

Product Code	Length (Inch)	Width (Inch)	Teeth Per Inch (TPI)	Type of Cut
--------------	---------------	--------------	----------------------	-------------

Without Handle

4-188-05-2-0	5	11/64	58	Second
4-188-06-2-0	6	11/64	58	Second
4-288-06-2-0	6	11/64	58	Second

Features

- Used for sharpening of all types of saws with fine cross tothing
- Triangular, with edges tapering towards the point
- Surfaces are single cut on 4-188 and double cut on 4-288
- Edges are single cut
- Width figures indicate the largest width of the file section

BAHCO® DOUBLE EDGE SAW FILE - "WASA"

Sharpening Files

Product Code	Length (Inch)	Width (Inch)	Height (Inch)	Teeth Per Inch (TPI)	Type of Cut
--------------	---------------	--------------	---------------	----------------------	-------------

Without handle

4-272-06-3-0	6	5/8	5/32	58	Smooth
--------------	---	-----	------	----	--------

Features

- For sharpening saws with straight, fine toothing
- Note that saws with hardened tooth points cannot be sharpened with a file
- Parallel, rhombic
- Surfaces and edges single cut

BAHCO® ERGO™ HALF ROUND RASPS

Rasps

Product Code	Length (Inch)	Width (Inch)	Height (Inch)	Teeth Per Inch (TPI)	Type of Cut
--------------	---------------	--------------	---------------	----------------------	-------------

With Bi-Molded ERGO™ Handle

6-342-08-1-2	8	53/64	5/16	64	Coarse
6-342-08-2-2	8	59/64	5/16	104	Medium

Without handle

6-342-08-1-0	8	53/64	5/16	64	Coarse
6-342-10-1-0	10	15/16	5/16	51	Coarse
6-342-12-1-0	12	1 1/16	3/8	38	Coarse

Features

- Designed for work in wood, plywood, wall board, plastics and other soft materials
- File's edges and surfaces are tapered towards the point with surfaces rasp cut and edges single cut

BAHCO® CABINET RASPS

Rasps

Product Code	Length (Inch)	Width (Inch)	Height (Inch)	Teeth Per Inch (TPI)	Type of Cut
--------------	---------------	--------------	---------------	----------------------	-------------

Without handle

6-343-08-3-0	8	7/8	7/32	142	Fine
6-343-10-3-0	10	1 1/16	15/64	117	Fine

Features

- Designed for work in wood, plywood, wall board, plastics and other soft materials
- File is thin and half round edges and surfaces tapered towards the point
Surface is rasp cut and edges are single cut



4-272-06-3-0

6-342-08-1-2

6-342-08-1-0

6-343-08-3-0



6-344-08-2-2

6-345-08-2-2

FM10

BAHCO® ERGO™ HAND RASPS

Rasps

Product Code	Length (Inch)	Width (Inch)	Height (Inch)	Teeth Per Inch (TPI)	Type of Cut
--------------	---------------	--------------	---------------	----------------------	-------------

With Bi-Molded ERGO™ Handle

6-344-08-2-2	8	²⁵ / ₃₂	¹ / ₄	104	Medium
--------------	---	-------------------------------	-----------------------------	-----	--------

Features

- Designed for work in wood, plywood, wall board, plastics and other soft materials
- File's edges and surfaces are parallel with surface rasp cut and one edge single cut

BAHCO® ERGO™ ROUND RASP

Rasps

Product Code	Length (Inch)	Diameter (Inch)	Height (Inch)	Teeth Per Inch (TPI)	Type of Cut
--------------	---------------	-----------------	---------------	----------------------	-------------

With Bi-Mold ERGO™ Handle

6-345-08-2-2	8	⁹ / ₃₂	²³ / ₆₄	104	Medium
--------------	---	------------------------------	-------------------------------	-----	--------

Features

- Designed for work in wood, plywood, wall board, plastics and other soft materials
- File surface is rasp cut
- File is round and tapered towards the point

BAHCO® ERGO™ FILEMASTER

Rasps

Product Code	Length (Inch)	Width (Inch)	Height (Inch)	Teeth Per Inch (TPI)
--------------	---------------	--------------	---------------	----------------------

With Bi-Molded ERGO™ Handle

FM10	10	²⁹ / ₃₂	⁷ / ₃₂	9 + 13
------	----	-------------------------------	------------------------------	--------

Features

- Designed for shear cuts on steel, plastics, laminates and hard woods. Also good for finishing in most materials
- Has curved teeth for fast removal of soft metals, lead, aluminum, soft woods and fillers
- The edges are parallel and uncut, and the surface has milled teeth - one side shear cut and one side curved teeth
- File coated with a protective layer of paint

BAHCO® ERGO™ HALF ROUND FILEMASTER

Rasps

Product Code	Length (Inch)	Width (Inch)	Height (Inch)	Teeth Per Inch (TPI)
With Bi-Molded ERGO™ Handle				
HRFM10	10	²⁹ / ₃₂	¹ / ₈	12

Features

- Designed for filing concave and flat surface, and large holes
- Has curved teeth for fast removal of soft metals, lead, aluminum, soft woods and fillers
- Edges are tapered towards the point and are uncut
- Half round surface are milled, curved teeth and concave back is uncut
- File coated with a protective layer of paint

BAHCO® FILE CLEANER

Accessories

Product Code
9-467-00-0

Features

- In order to ensure a good filing result, files should periodically be cleaned during use
- Has bristles on one side and a card of steel wire on the other
- Use the brush to clear clogged teeth
- Doing this regularly will improve the stock removal efficiency of the file, and extend its useful life

BAHCO® ROUND CHAIN SAW FILES

Chain Saw Files

Product Code	Length	Diameter (Inch)
Each file is packed in a skin-pack, which can be used as a protective sleeve.		
168-6-3.2-1P	6	¹ / ₈
168-6-3.5-1P	6	⁹ / ₆₄
168-8-4.0-1P	8	⁵ / ₃₂
168-8-4.5-1P	8	¹¹ / ₆₄
168-8-4.8-1P	8	³ / ₁₆
168-8-5.2-1P	8	¹³ / ₆₄
168-8-5.5-1P	8	⁷ / ₃₂
168-8-6.3-1P	8	¹ / ₄

Files are packed in 3 piece protective skin-pack, with perforation for easy separation.

168-8-4.0-3P	8	⁵ / ₃₂
168-8-4.8-3P	8	³ / ₁₆
168-8-5.5-3P	8	⁷ / ₃₂

Files are packed in 6 per paper box.

168-8-4.0-6	8	⁵ / ₃₂
168-8-4.5-6	8	¹¹ / ₆₄
168-8-4.8-6	8	³ / ₁₆
168-8-5.2-6	8	¹³ / ₆₄
168-8-5.5-6	8	⁷ / ₃₂

Features

- For sharpening of the cutting tooth on the saw chain



HRFM10



9-467-00-0-0

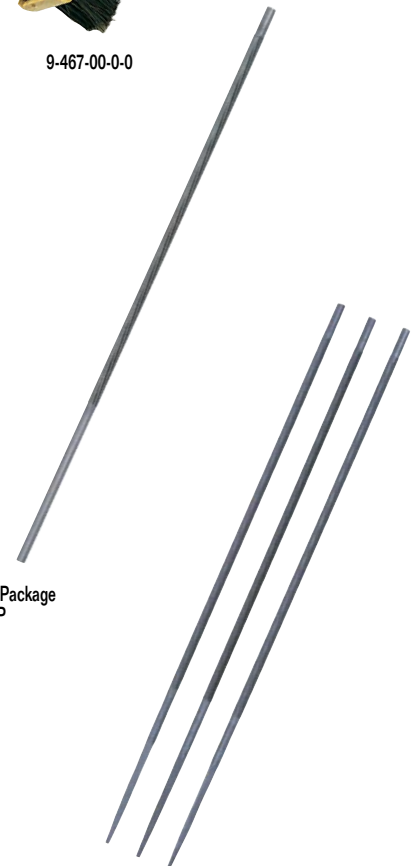

1 Piece Per Package
168-6-3.5-1P

3 Pieces Per Package
168-8-4.0-3P



166-6-16-2.5-12

BAHCO® FLAT CHAIN SAW FILE

Chain Saw File

Product Code	Length (Inch)	Width (Inch)	Height (Inch)
--------------	---------------	--------------	---------------

With Bi-Mold ERGO® Handle

166-6-16-2.5-12	6	5/8	3/32
-----------------	---	-----	------

Features

- Designed for filing of depth gauges on saw chains and for sharpening of brush cutter blades
- Files are packed 12 pieces per box
- File is flat with single cut surface, edges are round and uncut



9-486-C



PH-6604

BAHCO® ERGO™ ROUND CHAIN SAW FILE HANDLES

Product Code	Handle Number	Type	Packaging
9-486-C-10	C	ERGO™	10 Pack
9-486-C-1P	C	ERGO™	1 Individual
PH-6604-1P			1 Individual
PH-6604-25			25 Pack

Features

- Handle 9-486 is ergonomically shaped bi-molded plastic handle that provides soft, textured grip for comfort and control
- Handle 9-486 can hold both round chain saw files (type 168) and flat chain saw file (type 166)
- Handle PH-6604 is an all plastic handle designed for 8 inch round chain saw files with 3 integrated angle guides



9-484



9-488

BAHCO® PLASTIC FILE HANDLES

Comfortable Grip

Product Code	Handle Number	Packaging
--------------	---------------	-----------

Files are packed in 6 per paper box.

9-484-3.2-1P	3.2	Individual
9-484-5.2-1P	5.2	Individual
9-484-3.2-10	3.2	10 Pack
9-484-5.2-10	5.2	10 Pack
9-488-02-10	Needle/Pansar	10 Pack

Features

- The end covers the file tang and shoulder for safe and comfortable grip
- Plastic file handles designed for small sized files

PATENTED DESIGN IMPROVES SAFETY AND COMFORT

FILE HANDLES

TOOLS FOR THE TRADES



BAHCO® ERGO™ FILE HANDLES

Bi-Molded ERGO™ Handles

Product Code	Handle Number	Packaging
--------------	---------------	-----------

Designed for files of rectangular shape (flat, hand, etc) and for half round files.

9-485-04-1P	04	Individual
9-485-05-1P	05	Individual
9-485-06-1P	06	Individual
9-485-09-1P	09	Individual
9-485-13-1P	13	Individual
9-485-06-10	06	10-Pack
9-485-09-10	09	10-Pack
9-485-13-10	13	10-pack

Designed for shaped files (round, square, three square, etc.)

9-486-3.2-1P	3.2	Individual
9-486-04-1P	04	Individual
9-486-05-1P	05	Individual
9-486-07-1P	07	Individual
9-486-04-10	04	10-Pack
9-486-05-10	05	10-Pack
9-486-08-10	08	10-Pack

Features

- Ergonomically shaped bi-molded plastic handle provides soft, textured grip for comfort and control
- The end covers the file tang and shoulder for safe and comfortable grip



FILE SELECTION GUIDE ENGINEERING AND RASPS

Shape	Code	4"	6"	8"	10"	12"	14"
	1-100	5,2	06	09	09	13	13
	1-104				09	13	13
	1-106			09	09	13	
	1-110	5,2	06	09	09	13	13
	1-111	5,2	04	05			
	1-143	5,2	04	05	09	13	13
	1-210	5,2	06	09	09	13	
	1-320			09	09	13	
	6-342	5,2	06	09	09	13	
	6-343			08	09		
	6-344			09	09		
	1-160	3,2	04	07	07	08	
	1-170	3,2	04	07	07		
	1-230	3,2	04	07	07	08	
	6-345			07	07		

	Insert type	Handle tip	Handle size
Yellow field = Handle 9-484-XX-	3,2 5,2	Round shape	Small
Blue field = Handle 9-485-XX-	4, 5, 6, 8, 9	Oval shape	Medium
	13		Large
Orange field = Handle 9-486-XX-	4, 5, 6, 8	Round shape	Medium
	5, 8		Large



Example: Ergo Handle for file 1-100-12-1-0 should be 9-485-13-1P (1-pack) or 9-485-13-10 (10-pack)

FILE SELECTION GUIDE

SHARPENING FILES AND CHAIN SAW FILES

Shape	Code	4"	5"	6"	7"	8"	10"	12"
	166			04				
	4-138			04		05	09	13
	4-140			04		05	09	
	4-152					08		

	Insert type	Handle tip	Handle size
Handle 9-485-XX-	4, 5, 6, 8, 9	Oval shape	Medium
	13		Large



Example: Ergo Handle for file 166-6-16-2.5-12 should be 9-485-04-1P (1-pack) or 9-485-04-10 (10-pack)

FILE SELECTION GUIDE

FILE SELECTION GUIDE

NEEDLE FILES AND PANSAR FILES

Shape	Code	140mm	160mm	180mm	12"	14"
	2-300	x	x	x		
	2-301	x	x			
	2-302	x	x	x		
	2-303	x	x	x		
	2-304	x	x	x		
	2-304-D	x	x			



Handle 9-488-02-10

Example: Handle for file 2-300-14-0-0 should be 9-488-02-10 (10-pack)

TOOLS FOR THE TRADES



HSSG-G1225M



HSSG-M1227M



HSSG-A1225M



HSSG-C1225M



HSSG-E1222M



HSSG-D1211M

BAHCO® ROTARY BURRS

Arch Pointed Nose

Product Code	Diameter Of Head	Length of Head	Toothing
HSSG-G0618M	1/4	1/16	Medium
HSSG-G1220M	1/2	3/4	Medium
HSSG-G1225EC	1/2	1	Extra Coarse
HSSG-G1225M	1/2	1	Medium
HSSG-F0618M	1/4	1/16	Medium
HSSG-F1225M	1/2	1	Medium

Conical Pointed Nose

Product Code	Diameter Of Head	Length of Head	Toothing
HSSG-M0618M	1/4	1/16	Medium
HSSG-M1227M	1/2	1 1/16	Medium

Cylindrical

Product Code	Diameter Of Head	Length of Head	Toothing
HSSG-A0616M	1/4	5/8	Medium
HSSG-A1020M	3/8	3/4	Medium
HSSG-A1225EC	1/2	1	Extra Coarse
HSSG-A1225M	1/2	1	Medium

Cylindrical Round Nose

Product Code	Diameter Of Head	Length of Head	Toothing
HSSG-C0616M	1/4	5/8	Medium
HSSG-C1020M	3/8	3/4	Medium
HSSG-C1225EC	1/2	1	Extra Coarse
HSSG-C1225M	1/2	1	Medium

Oval

Product Code	Diameter Of Head	Length of Head	Toothing
HSSG-E0614M	1/4	9/16	Medium
HSSG-E1222EC	1/2	7/8	Extra Coarse
HSSG-E1222M	1/2	7/8	Medium

Spherical

Product Code	Diameter Of Head	Length of Head	Toothing
HSSG-D0606M	1/4	1/4	Medium
HSSG-D0807M	5/16	1/4	Medium
HSSG-D1009M	3/8	3/8	Medium
HSSG-D1211EC	1/2	7/16	Extra Coarse
HSSG-D1211M	1/2	7/16	Medium

Features

- High Speed Steel burrs used for deburring soft steel, bronze, and brass
- Used to deburr irregular objects and finishing work inside a confined space
- Medium Toothing for machining unhardened steel and other moderately hard materials under normal conditions
- Extra Coarse Toothing for soft materials when good stock removal is required. Counteracts chip build-up between teeth



782-U

BAHCO® WIRE BRUSH

Product Code	Description
782-U	Wire brush

Features

- General purpose utility wire brush for cleaning off dirt, rust, paint etc....

BAHCO® ERGO™ SCRAPERS

ERGO™ Carbide Blade Scrapers

Product Code	Length (Inch)	Blade Included:
625	11	# 449 Triangle Shaped Carbide Blade
650	12	# 442 - 2" Carbide Blade
665	12	# 451 - 2 1/2" Carbide Blade

Features

- Two-component handle provides better grip and comfort during use
- Scrapers for use on all kinds of surfaces for removal of paint, glue, varnish, rust, gaskets, chalk, grout, mortar, etc.
- Four interchangeable carbide blades for precision work are available for different surface applications
- 625 Scraper comes with convenient plastic holder
- The heavy duty scraper head for models 650 and 665 is designed for wide material removal when extra strength is required
- Scraper 665 comes with large plastic knob for two-handed operation for heavy duty use
- Blades stays sharp up to 50 times longer than conventional steel blades



BAHCO® REPLACEMENT CARBIDE SCRAPER BLADES

Carbide Blades

Product Code	Length (Inch)	Description
449		Triangle Shape, for 625 Scraper
625-DROP		Drop Shape, for 625 Scraper
625-PEAR		Pear Shape, For 625 Scraper
625-ROUND		Round Shape, For 625 Scraper
442	2	For 650 and 665 Scrapers
451	2 1/2	For 650 and 665 Scrapers
850-1	2	Wavy for 650 and 665 Scrapers
865-1	2 1/2	Wavy for 650 and 665 Scrapers

Features

- Blades stays sharp up to 50 times longer than conventional steel blades

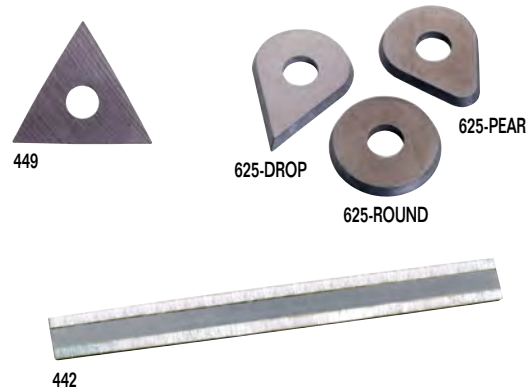

GASKET SCRAPER

Plastic Handle

Product Code	Blade Length (Inch)	Overall Length	Blade Width
JHWGSC-12	8 7/8	13	1 1/2

Features

- Designed for removing gaskets and carbon
- Comfortable four-sided yellow plastic handle
- Blade coated to resist corrosion

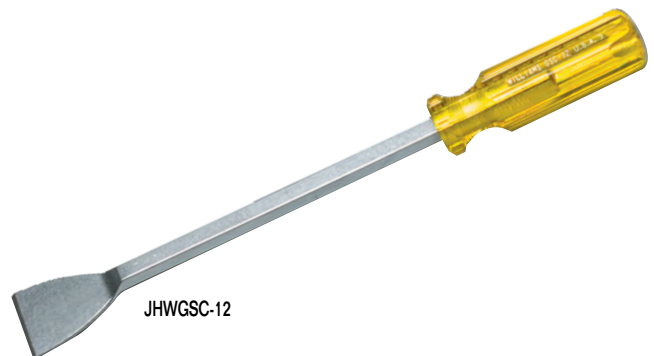

GASKET SCRAPER

Bi-Mold Comfort Grip Handle

Product Code	Blade Length (Inch)	Overall Length	Blade Width
JHW40000	6	9 3/4	7/8

Features

- Bi-mold handle provides comfortable grip, reducing hand fatigue
- Ideal for gasket removal and cleaning rust and corrosion





474



424P-18

424P-S6-PP



424-S6-LR



434-S3-EUR

434-S6-EUR

BAHCO® CABINET SCRAPERS

For Carpentry Work

Product Code	Length (Inch)
474-125-0.60	5
474-125-0.80	5
474-150-0.80	6

Features

- Blade of cold-rolled, hardened and tempered chrome-nickel steel
- White plastic edge protector

BAHCO® WOODWORKING CHISELS

Comfort Grip

Product Code	Overall Length (Inch)	Blade Length (Inch)	Tip Width (Inch)
424P-6	10 ½	5 ½	¼
424P-10	10 ½	5 ½	⅜
424P-12	10 ½	5 ½	½
424P-18	10 ½	5 ½	¾
424P-25	10 ½	5 ½	1
424P-32	10 ½	5 ½	1 ¼

Chisel Sets

Product Code	Description
424P-S6-PP	Includes chisel sizes: ¼, ⅜, ½, ¾, 1, 1 ¼ in Polyester Pouch
424P-S6-LR	Includes sizes: ¼, ⅜, ½, ¾, 1, 1 ¼ in Leather Pouch

Features

- Specially designed two-component handle maximizes control and comfort, giving an excellent grip
- Precision ground blade for maximum sharpness
- Varnished blade for increased rust resistance
- Hardened and tempered high quality steel for long lasting performance with 4 mm to 40 mm (5/32" to 1-9/16") size range
- Protective holster and tip protector included
- Comfortable two-component handle fits comfortably into the hand, and provides a nonslip grip
- Perfect for fine carpentry
- Blade guard protects working edges of blade when not in use

BAHCO® ERGO™ CHISELS

High-Quality Steel

Product Code	Overall Length (Inch)	Blade Length (Inch)	Tip Width (Inch)
434-6	10 ¾	5 ½	¼
434-10	10 ¾	5 ½	⅜
434-12	10 ¾	5 ½	½
434-18	10 ¾	5 ½	¾
434-25	10 ¾	5 ½	1
434-28	10 ¾	5 ½	1 ¼
434-38	10 ¾	5 ½	1 ½

Chisel Sets

Product Code	Description
434-S3-EUR	Includes chisel sizes: ½, ¾, 1 in a Cardboard Box
434-S6-EUR	Includes chisel sizes: ¼, ⅜, ½, ¾, 1, 1 ¼ in a Wooden Box

Features

- Two component ergonomic grip handle
- Splitproof handle allows repeated hammer blows
- Safety guard and rounded shoulders for added security
- Precision ground blade for maximum sharpness
- Hardened and tempered for long lasting performance
- Honed and ready to use
- Polished blade for rust resistance
- Protective holster included

BAHCO® QUICK CLAMPS - QCB SERIES

Power Lever System

Product Code	Capacity (Inches)	Clamping Force
QCB-150	6	450 lbs
QCB-300	12	450 lbs
QCB-450	16	450 lbs
QCB-600	23	450 lbs
QCB-900	35	450 lbs
QCB-1250	49	450 lbs

Features

- Variable speed mechanism, which makes it easier to reach high clamping force
- Removable pads, with V-groove



BAHCO® QUICK CLAMPS - QCG SERIES

Product Code	Capacity (Inches)	Clamping Force
QCG-150	6	275 lbs
QCG-300	12	275 lbs

Features

- Easy access in more confined spaces thanks to the smaller body
- Easy to turn in to a spreader with the Spreader button
- Easy access release mechanism
- Comfortable handle from ALL angles, you can use upside down, front to back



BAHCO® SPRING CLAMPS

Product Code	Capacity (Inches)
420SC-25	1
420SC-50	2

Features

- Handy spring clamps with a movable gripping surface for odd shapes



BAHCO® SCREW CLAMPS

Professional

Product Code	Overall Length (Inches)	Maximum Capacity (Inches)
420SH-50-100	4	2
420SH-50-200	8	2
420SH-60-120	5	2
420SH-60-300	12	2
420SH-80-160	6	3
420SH-100-200	8	4
420SH-120-250	10	5
420SH-120-300	12	5
420SH-120-400	16	5
420SH-120-500	20	5
420SH-120-600	24	5
420SH-120-800	31	5
420SH-120-1000	39	5
420SH-120-1250	49	5
420SH-120-1500	59	5
420SH-140-400	16	6
420SH-175-400	16	7

Features

- Professional F clamp with one fixed and one sliding bracket, fitted to a galvanized profiled steel rail.
- Zinc plated screw with special, plastic covered ball swivel foot for secure and easy clamping of odd shapes.
- Tough and weather resistant, square shaped plastic grip





2744

BAHCO® MULTI-PURPOSE SNIPS

Bi-Mold Comfort Grip Handles

Product Code	Overall Length (Inches)
2744	7 1/2

Features

- Lightweight yet strong multi-purpose snip for cutting light sheet metal, leather, wire, plastic, wood, etc.

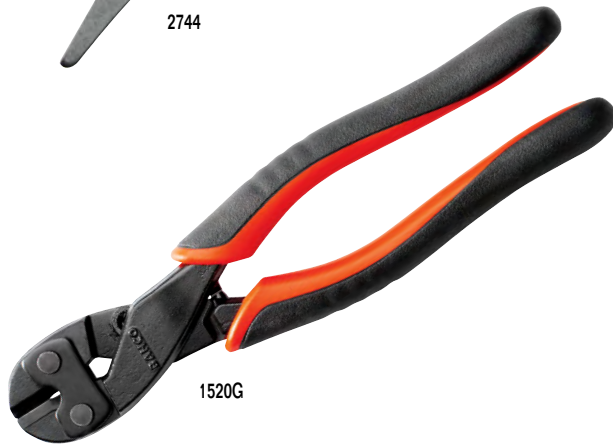

1520G

BAHCO® MINI BOLT CUTTER

Bi-Mold Comfort Grip Handles

Product Code	Overall Length (Inches)
1520G	8

Features

- Access tough to reach work
- Bi-mold comfort grips combine durability and a secure non-slip grip
- Cuts nails and bolts up to 1/4 diameter



4559

BAHCO® BOLT CUTTERS

Comfort Grip Handles

Product Code	Overall Length	Maximum Cutting Capacity For Rebar (Inch)	Replacement Jaw Kit (Includes Jaws, Bolts, and Steel Plates)
4559-12	12	1/4	4559-12B JC
4559-18	18	3/16	4559-18B JC
4559-24	24	3/8	4559-24B JC
4559-30	30	1/2	4559-30B JC
4559-36	36	5/8	4559-36B JC
4559-42	42	5/8	4559-42B JC

Features

- Comfortable rubber grips combine durability and a secure non-slip grip
- Lightweight steel tube handles provide ease of control while offering solid durability
- Unique manufacturing method results in high-precision cutting edges

BAHCO® PUTTY KNIFE

Two component handle for better grip

Product Code	Overall Length (Inches)
2489	9

Features

- For the application and smoothing of adhesives, putties and body dent fillers
- Two component handle for better grip
- Hardened stainless steel blade that extends through the handle



2489

BAHCO® STUD REMOVER

Chrome Finish

Product Code	Overall Length (Inches)	Head Thickness
4553	12	3/8

Features

- For holding and removing studs
- High-performance alloy steel
- Chrome plated finishing
- Thick and round handle to increase strength
- Electrode cap remover at the handle end of the wrench



4553

BAHCO® SAFETY GLASSES

Product Code
3870-SG11

Features

- Scratch resistant
- Polycarbonate
- 99.9% UV protection



3870-SG11

TAPE MEASURE

Construction Grade Tape Rule

Product Code	Blade Length (Width and Length Inch)
JHWTM25X1	1 x 25
JHWTM16X1	1 x 16

Features

- Measurements on both sides of the blade
- Auto lock feature
- Triple riveted stainless steel magnetic hook on the end of the blade



Measurements on both sides of the blade

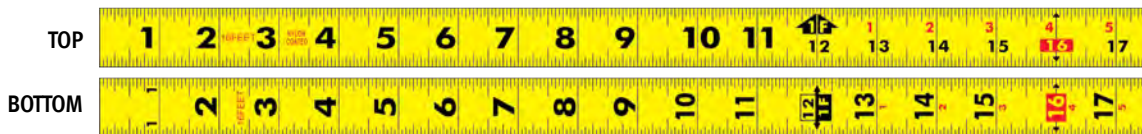



LTS-30-E

BAHCO® LONG TAPE

Professional Construction Grade

Product Code	Blade Length
LTS-30-E	100 ft (30 M)
LTS-50-E	164 ft (50 M)
LTS-100-E	328 ft (100 M)

Features

- SAE & Metric markings
- 5/8" (16 mm) Blade Width
- Strong fiberglass tape bonded with over 16,000 strands
- Double nylon blade coating for extra wear resistance

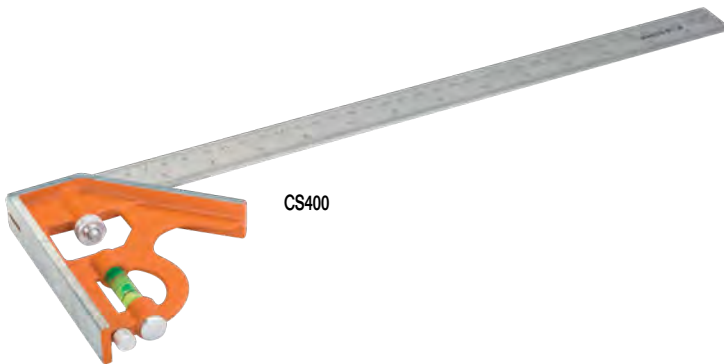

CS400

BAHCO® SLIDING COMBINATION SQUARES WITH METAL SCRIBER

Durable Polyester

Product Code	Overall Length (Inch)
CS150	6
CS300	12
CS400	16

Features

- Easy to use combination square with both metric and imperial markings
- Adjustable depth for repeated marking and scribing
- Built-in level bubble for approximate marking. Includes a metal scriber housed in the handle



SR300-E



9045-B-250



9572-200



P-HB

BAHCO® RULERS, SQUARE, SLIDING BEVEL, PENCIL

Construction Grade SAE and Metric

Product Code	Overall Length (Inches)	Description
SR150-E	6	Ruler
SR200-E	8	Ruler
SR300-E	12	Ruler
SR600-E	24	Ruler
ST1000-E	39	Ruler
9045-B-250	10	Square, Metric Only
9572-200	8	Sliding bevel
P-HB		Pencil



416-400



426TOR9

BAHCO® LEVELS

Precision

Product Code	Description
426TOR9	9" Torpedo level
416-400	16" Level
416-600	24" Level

Features

- Solid aircraft grade aluminum
- 3 vials: plumb, horizontal and 45 degree
- V Groove base for use on pipes
- Rare earth magnets on base
- Accurate to 0.5 mm/m

BAHCO® THREE POUCH BELT SET

Product Code	Dimensions W x H (Inches)
4750-3PB-1	27 x 10

Features

- Strong construction with riveted reinforcement
- Easy to adjust comfortable nylon belt with 2 inch quick release buckle



4750-3PB-1

BAHCO® UNIVERSAL POUCH

Product Code	Dimensions W x H (Inches)
4750-UP-1	12 x 11

Features

- Riveted for unbreakable strength
- Measuring tape clip
- Leather slots ideal for holding longer tools.
- Two deep multi purpose open pockets provide for quick tool recognition.



4750-UP-1

BAHCO® ELECTRICIANS POUCH

Product Code	Dimensions W x H (Inches)
4750-EP-1	10 x 12

Features

- Universal tool loop for larger tools to keep them organized
- Chain hook for easy access to insulated tapes
- Additional pocket for smaller tools
- Main deep pocket for safe storage
- Real leather slots on the sides



4750-EP-1

BAHCO® TWO POCKET POUCH

Product Code	Dimensions Wx H (Inches)
4750-2PP-1	9 x 11

Features

- Wide pockets hold plenty of tools
- Pocket position prevents tools from falling out



4750-2PP-1

BAHCO® HEAVY DUTY LEATHER BELT

Product Code	Description
4750-HDLB-1	Fits waist 28" to 50"

BAHCO® HAMMER HOLDER

Product Code	Dimensions Wx H (Inches)
4750-HHO-2	4 x 11

Features

- Fits BAHCO® heavy duty leather belt
- Quick access to hammer



4750-HDLB-1



4750-HHO-2

BAHCO® ANTI SLIP KNEE PADS

Product Code	Dimensions Wx H (Inches)
4750-KP-1	4 x 7

Features

- Universal lightweight knee pads for different kinds of surfaces
- Heavy duty cups ensure comfort and safety when used in difficult conditions



4750-KP-1

BAHCO® PLASTIC TOOL BOXES

Product Code	Length (Inches)	Width (Inches)	Height (Inches)
4750PTB50	19 ½	10 ½	11 ½
4750PTB60	23 ½	11 ½	12
4750PTB65	25 ½	11 ½	12

Features

- When lifted the aluminum handle blocks the bottom from accidentally opening
- Small Transparent detachable boxes are perfect for organizing small items
- Portable tray
- Heavy duty boxes made of virgin polypropylene are resistant to hot and cold temperatures
- Strong and sturdy boxes, 2 mm thick, can take high load capacity, even allowing the user to stand on them
- Metallic latches are galvanized making them durable and rust resistant
- Pad lock can be added to the box



4750PTB60



4750PTB65



4750PTW47

BAHCO® PLASTIC TOOL BOX ON WHEELS

Product Code	Length (Inches)	Width (Inches)	Height (Inches)
4750PTW47	24 ¾	11 ½	18 ½

Features

- The upper box can be used as a regular tool box and the bottom box is perfect for heavier tools
- Wheels are made of PP and EVA, for smooth and silent rolling and absorbing of impacts
- Two small transparent detachable boxes are perfect for organizing small items
- Portable tray
- Heavy duty boxes made of virgin polypropylene are resistant to hot and cold temperatures
- Strong and sturdy boxes, 2 mm thick, can take high load capacity, even allowing the user to stand on them
- Metallic latches are galvanized making them durable and rust resistant
- Top and bottom sections are connected with latches

HAND CARRY STORAGE

TOOLS FOR THE TRADES



4750FB4-18



BAHCO® LAPTOP AND TOOL BAG WITH HARD BOTTOM

Product Code	Length (Inches)	Width (Inches)	Height (Inches)
4750FB4-18	17	6	13 ¾

Features

- Material is a combination of Denier 600 and 1680 polyester that prevents the bag from damage and provides lightweight flexibility
- Plastic hard bottom and double stitching reinforcement is 100% waterproof and easy to clean
- Pockets provide easy access to tools
- Detachable compartments
- Padded compartment is ideal for laptop
- Tools not included

BAHCO® 24" OPEN TOOL BAG WITH WHEELS

Product Code	Length (Inches)	Width (Inches)	Height (Inches)
4750FB2W-24A	24	12	15 ¾

Features

- Material is a combination of Denier 600 and 1680 polyester that prevents the bag from damage and provides lightweight flexibility
- Plastic hard bottom and double stitching reinforcement is 100% waterproof and easy to clean
- Heavy duty PVC zippers makes closing and opening quick and easy
- Pockets provide easy access to tools
- Big side pouches: left side is detachable and right side is fixed
- Special size pocket for 10" tablet
- Telescopic handle – max 38"
- Wheels provide easy quiet rolling



4750FB2W-24A

BAHCO® 19" OPEN TOOL BAG WITH HARD BOTTOM

Product Code	Length (Inches)	Width (Inches)	Height (Inches)
4750FB1-19A	19	9	14

Features

- Material is a combination of Denier 600 and 1680 polyester that prevents the bag from damage and provides lightweight flexibility
- Plastic hard bottom and double stitching reinforcement is 100% waterproof and easy to clean
- Heavy duty PVC zippers makes closing and opening quick and easy
- Velcro straps store long tools on both upper sides of the bag
- Soft grip handles made of rubberized material provides a user friendly grip and isolates against cold temperature



4750FB1-19A

BAHCO® 19" TOOL BAG WITH HARD BOTTOM

Product Code	Length (Inches)	Width (Inches)	Height (Inches)
4750FB1-19B	19	9	14

Features

- Material is a combination of Denier 600 and 1680 polyester that prevents the bag from damage and provides lightweight flexibility
- Plastic hard bottom and double stitching reinforcement is 100% waterproof and easy to clean
- Velcro straps store long tools on both upper sides of the bag
- Soft grip handles made of rubberized material provides a user friendly grip and isolates against cold temperature
- Easy access to the handle through the cover
- Pockets provide easy access to tools
- Internal detachable tool panel with Velcro system for quickly taking out and returning tools



4750FB1-19B



4750FB2-19A

BAHCO® CLOSED TOOL BAG WITH HARD BOTTOM

Product Code	Length (Inches)	Width (Inches)	Height (Inches)
4750FB2-19A	19	9	14
4750FB2-24A	24	10	15

Features

- 600 Denier polyester prevents the bag from damage and provides flexibility and is lightweight
- Plastic hard bottom and double stitching reinforcement is 100% waterproof and easy to clean
- Heavy duty PVC zippers makes closing and opening quick and easy
- Quick adjustable straps store long tools
- Multiple internal and external pockets



4750FB3-12

BAHCO® 12" ELECTRICIAN'S BAG WITH HARD BOTTOM

Product Code	Length (Inches)	Width (Inches)	Height (Inches)
4750FB3-12	11 ½	7 ½	11 ½

Features

- 600 Denier polyester prevents the bag from damage and provides flexibility and is lightweight
- Plastic hard bottom and double stitching reinforcement is 100% waterproof and easy to clean
- Pockets provide easy access to tools
- Cable loop holder
- Central big compartment for bit tools and materials



4750FB5B

BAHCO® TOOL ORGANIZERS

Product Code	Length (Inches)	Width (Inches)	Height (Inches)
4750FB5B	13	10 ½	2 ¾
4750FB5C	16	12	3 ½

Features

- Perfect for organizing tools
- Elastic straps for tool distribution in the bottom and upper side
- Card holder on the front and label holder on the side for quick identification



4750FB5C

BAHCO® TOOL BACKPACK

Made from durable polyester

Product Code	Overall Length (Inch)
3875-BP1	16

Features

- Multiple inner compartments including a padded compartment for laptop
- Made from durable polyester
- Polypropylene straps to reinforce the structure
- Zip closed and secured by hardwearing safety straps
- Reflecting band
- Adjustable shoulder strap
- Foam padded polyester back
- Color labels with maximum weight, safety guidelines and production order number
- Tested as textile sling according to EN 1492-1+A1 2008
- Suitable for working at height



Items show not included

3875-BP1

BAHCO® 36" TOOL BAG

Product Code	Length (Inches)	Width (Inches)	Height (Inches)
AG-BAG-36	36	12	12

Features

- Two Handles
- Ideal for storing and toting tools, parts and supplies



AG-BAG-36

BAHCO® 17" OPEN TOTE CADDY TOOL BAG ORGANIZER

Product Code	Length (Inches)	Width (Inches)	Height (Inches)
3100TB	17	10	13

Features

- Hard plastic bottom keeps moisture out of organizer
- Two Handles
- Ideal for storing and toting tools, parts and supplies



3100TB



JHW40201



JHW40251



JHW40150

UTILITY TOOLS AND SETS

Bi-Mold Comfort Grip Handles

Product Code	Description	Contents Include
JHW40201	4 Piece Mini Pick & Hook Set	Straight pick 45° bent tip pick 90° bent tip pick Full semi-circular hook
JHW40251	4 Piece Utility Tool Set	Gasket scraper Scratch awl Cotter pin puller Hose removal tool
JHW40150	Magnetic pick-up tool with telescoping shaft	N/A

Features

- Bi-mold handles provide comfortable grip, reducing hand fatigue
- Use for scribing, alignment, o-ring removal, and parts cleaning
- Small size makes them ideal for hard to reach work surfaces
- Telescopic pick-up tool features powerful magnetic tip
- Magnetic pick-up tool extended length is 18¼", pick-up weight is 1¼ pounds
- 40201 Overall length: 6 inches, handle length: 2¾"



JHW42301



JHW42302



JHW42304A

CREEPERS

Heavy Duty - Low Profile

Product Code	Description	Weight Capacity (lb)
JHW42301	Heavy-Duty Drop-Shoulder Creeper	570
JHW42302	Mechanic's Seat Creeper	380
JHW42304A	Adjustable-Height Swivel Seat-Creeper	380

Features - Heavy-Duty Drop-Shoulder Creeper

- Low-profile design rests only 2" from the ground
- Drop-rail design allows greater shoulder and arm clearance
- 16 gauge, ¾" square-stock steel frame
- 1" padding on bed and 2" padding on headrest
- Six 2-½" diameter hooded casters shield user's clothing from dirt and grease

Features - Mechanic's Seat Creeper

- Seat is topped with comfortable 1-½" thick foam padding
- 1" square-stock steel frame
- Four 2-½" diameter hooded casters shield user's clothing from dirt and grease
- Heavy-duty 3-section plastic pan stores tools and small parts

Features - Adjustable-Height Swivel Seat-Creeper

- Height adjusts from 17" to 22"
- Seat swivels a full 360°
- Four 2-½" diameter hooded casters shield user's clothing from dirt and grease
- Steel tube frame supports cylinder for ultimate strength
- Bottom pan serves as storage for tools and small parts

SET-UP WEDGES

Heavy Duty Machine Shop Tools

Product Code	Length	Width	Thick End
JHWWG-3	3	1	1/4
JHWWG-5	5	1	1/2
JHWWG-6	6	1 1/4	3/4

Features

- Set-up wedges are used for setting-up work on planers, shapers, milling machines and other similar applications



Made in U.S.A.



JHWWG-5

EYEBOLTS

Plain Pattern

Product Code	Shank Diameter (Inches)	Threads per Inch	Capacity of Vertical Load (lbs)	Length of Shank (Inches)	Inner Diameter (Inches)	Head Cross Section Thickness (Inches)	Overall Length (Inches)	Ultimate Strength (lbs)
JHWEB-1T	1/4	20	500	1	3/4	9/32	2 1/4	2500
JHWEB-2T	5/16	18	900	1 1/8	27/32	9/32	2 5/8	4500
JHWEB-3T	3/8	16	1,300	1 1/4	1 1/32	5/16	2 29/32	6500
JHWEB-4T	7/16	14	1,800	1 3/8	1 1/16	3/8	3 1/4	9000
JHWEB-5T	1/2	13	1,400	1 1/2	1 1/8	5/32	3 5/8	12000
JHWEB-6T	9/16	12	3,000	1 5/8	1 1/4	1/2	3 31/32	15000
JHWEB-7T	5/8	11	4,000	1 3/4	1 5/16	9/16	4 3/8	20000
JHWEB-8T	3/4	10	5,000	2	1 17/32	5/8	4 25/32	25000
JHWEB-9T	7/8	9	7,000	2 1/4	1 3/8	13/16	5 9/16	35000
JHWEB-10T	1	8	9,000	2 1/2	1 3/4	29/32	6 1/8	45000
JHWEB-11T	1 1/8	7	12,000	2 3/4	1 19/16	1 1/16	6 7/8	60000
JHWEB-12T	1 1/4	7	15,000	3 1/2	2 5/32	1 5/32	7 1/2	75000
JHWEB-14T	1 1/2	6	21,000	3 3/4	2 7/16	1 13/32	8 19/16	105000
JHWEB-15T	1 3/4	5	28,000	3 3/4	2 29/32	1 21/32	9 7/8	140000
JHWEB-16T	2	4 1/2	38,000	4	3 3/32	1 27/32	11	190000
JHWEB-17T	2 1/2	4	56,000	5	4	2 1/4	13 1/2	280000

ANSI Spec: B18.15 1985

Features

- Forged from the best quality carbon steel, hardened and tempered to ensure increased strength and toughness and reduce liability or breakage
- Each lot is tested and inspected to insure conformance to specifications
- Available with UNC Class 2A thread only
- Plain pattern eyebolts must never be used to lift an angular load
- Eyebolt shanks should never be undercut or eyebolt shank diameters reduced
- To obtain greatest strength from an eye bolt, it must fit reasonably tight in the hole into which it is screwed to prevent unscrewing due to twist of cable
- Tightness and seating must be checked after initial load



Made in U.S.A.



JHWEB-9T

EYEBOLTS

Shoulder Pattern

Product Code	Shank Diameter (Inches)	Threads per Inch	Length of Shank (Inches)	Inner Diameter (Inches)	Head Cross-Section Thickness (Inches)	Overall Length (Inches)	Shoulder Width (Inches)	Ultimate Strength (lbs)
JHWEB-21T	1/4	20	1	3/4	9/32	2 7/16	9/16	2500
JHWEB-22T	5/16	18	1 1/8	27/32	9/32	2 7/8	19/32	4500
JHWEB-23T	3/8	16	1 1/4	1	5/16	3 11/32	21/32	6500
JHWEB-24T	7/16	14	1 3/8	1 1/16	3/8	3 23/32	27/32	9000
JHWEB-25T	1/2	13	1 1/2	1 1/8	7/16	4 1/32	29/32	12000
JHWEB-26T	9/16	12	1 5/8	1 11/32	7/32	4 13/32	19/16	15000
JHWEB-27T	5/8	11	1 3/4	1 11/32	9/16	4 3/4	1 1/32	20000
JHWEB-28T	3/4	10	2	1 1/2	11/16	5 11/32	1 5/16	25000
JHWEB-29T	7/8	9	2 1/4	1 3/8	13/16	6	1 7/16	35000
JHWEB-30T	1	8	2 1/2	1 19/16	7/8	6 3/4	1 3/8	45000
JHWEB-31T	1 1/8	7	2 3/4	1 19/16	1 1/16	7 1/2	1 3/4	60000
JHWEB-32T	1 1/4	7	3	2 1/8	1 3/16	8 3/8	2 1/32	75000
JHWEB-34T	1 1/2	6	3 1/2	2 19/32	1 1/2	9 3/8	2 9/16	105000
JHWEB-35T	1 3/4	5	3 3/4	2 27/32	1 19/32	10 3/4	2 1/2	140000
JHWEB-36T	2	4 1/2	4	3 3/32	1 7/8	12	2 29/32	190000

ANSI Spec: B18.15 1985

Features

- Forged from the best quality carbon steel, hardened and tempered to ensure increased strength and toughness and reduce liability or breakage
- Each lot is tested and inspected to insure conformance to specifications
- Available with UNC Class 2A thread only
- Eyebolt shanks should never be undercut or eyebolt shank diameters reduced
- Shoulder eye bolts must be properly seated (should bear firmly against the mating part) otherwise the working loads must be reduced substantially
- A steel washer or spacer may be required for proper seating
- To obtain greatest strength from an eye bolt, it must fit reasonably tight in the hole into which it is screwed to prevent unscrewing due to twist of cable
- Tightness and seating must be checked after initial load



Made in U.S.A.



JHWEB-29T

EYEBOLT ANGULAR LOADING RATED CAPACITY

Material Data

Grade: Carbon Steel
Heat Treat: Quench & Draw

Mechanical Properties

Grain Size: 5 or finer
Tensile: 65,000 PSI Min
Yield: 30,000 PSI Min

Elongation: 30% Min
Reduction of Area: 60% Min

Part Number Plain	Shank Diameter	Threads Per Inch	Capacity of Vertical Load (lbs)	Ultimate Strength (lbs)	Angular Loading Rated Capacity (Pounds)			
					0 Degree	30 Degree	60 Degree	90 Degree
JHWEB-1T	1/4	20	500	2,500				
JHWEB-2T	5/16	18	900	4,500				
JHWEB-3T	3/8	16	1,300	6,500				
JHWEB-4T	7/16	14	1,800	9,000				
JHWEB-5T	1/2	13	2,400	12,000				
JHWEB-6T	9/16	12	3,000	15,000				
JHWEB-7T	5/8	11	4,000	20,000				
JHWEB-8T	3/4	10	5,000	25,000				
JHWEB-9T	7/8	9	7,000	35,000				
JHWEB-10T	1	8	9,000	45,000				
JHWEB-11T	1 1/8	7	12,000	60,000				
JHWEB-12T	1 1/4	7	15,000	75,000				
JHWEB-14T	1 1/2	6	21,000	105,000				
JHWEB-15T	1 3/4	5	28,000	140,000				
JHWEB-16T	2	4 1/2	38,000	190,000				
JHWEB-17T	2 1/2	4	56,000	280,000				
JHWEB-21T	1/4	20	500	2,500	440	70	NR	NR
JHWEB-22T	5/16	18	900	4,500	720	170	NR	NR
JHWEB-23T	3/8	16	1,300	6,500	1,080	335	185	150
JHWEB-24T	7/16	14	1,800	9,000	1,480	435	275	215
JHWEB-25T	1/2	13	2,400	12,000	1,960	695	460	365
JHWEB-26T	9/16	12	3,000	15,000	3,140	1,220	735	600
JHWEB-27T	5/8	11	4,000	20,000	3,140	1,220	735	600
JHWEB-28T	3/4	10	5,000	25,000	4,600	1,950	1,095	960
JHWEB-29T	7/8	9	7,000	35,000	6,400	2,710	1,750	1,485
JHWEB-30T	1	8	9,000	45,000	8,400	3,595	2,450	2,160
JHWEB-31T	1 1/8	7	12,000	60,000	10,600	4,235	3,380	2,985
JHWEB-32T	1 1/4	7	15,000	75,000	13,400	5,540	3,675	3,285
JHWEB-34T	1 1/2	6	21,000	105,000	19,600	8,410	5,590	5,080
JHWEB-35T	1 3/4	5	28,000	140,000	28,000	12,100	8,250	7,370
JHWEB-36T	2	4 1/2	38,000	190,000	38,000	15,970	10,910	9,740

NR = Not Recommended.

- No greater load should be allowed than that given under rated capacity in each table of dimensional data
- Safety Factor: Rated capacity is figured with 5:1 safety factor for zero degree straight vertical pull

FLUTED SCREW EXTRACTORS

Straight, Tapered Flutes

Product Code	Drill Size (Inches)	For Use on Bolt Sizes (Inches)
JHWEX-21A	1/8	1/4 to 5/16
JHWEX-21B	9/16	3/8
JHWEX-22A	7/32	7/16
JHWEX-24A	9/16	1/2 to 9/16
JHWEX-25B	3/8	5/8
JHWEX-25A	15/32	3/4
JHWEX-26A	9/16	7/8
JHWEX-28	2 1/32	1 to 1 1/8
JHWEX-29	1 9/16	1 1/4 to 1 3/8
JHWEX-30	1 1/16	1 1/2

JHWEXS-30 6 Piece Screw Extractor Set

Contents Include:

Product Code	Product Code	Product Code
JHWEX-21A	JHWEX-22A	JHWEX-25B
JHWEX-21B	JHWEX-24A	JHWEX-25A

JHWEXS-10 10 Piece Screw Extractor Set

Contents Include:

Product Code	Product Code	Product Code	Product Code	Product Code
JHWEX-21A	JHWEX-22A	JHWEX-25B	JHWEX-26A	JHWEX-29
JHWEX-21B	JHWEX-24A	JHWEX-25A	JHWEX-28	JHWEX-30

Features

- Designed for quick, easy removal of left or right-handed broken screws, bolts, studs or other threaded forms
- Drill bit sizes to be used are stamped on each extractor
- A hole is first drilled in the broken stem and the right size Williams extractor is then inserted



FEELER GAUGE SET

Heavy Duty Machine Shop Tools

Product Code	Description	Thickness	Number of Blades
JHWGS-1	Master Feeler Gauge Set	.0015 - 1/32	25

Features

- 25 blades 3-5/16" x 1/2" in the following thicknesses: .0015, .002, .003, .004, .005, .006, .007, .008, .009, .010, .011, .012, .013, .014, .015, .016, .018, .020, .022, .024, .025, .028, .030, .032, and .035
- Both decimal and equivalent metric size etched in each blade
- Gauges supplied in holder with knurled lock-nut which allows the user to select the required blade size and lock it into position

Product Code	Description	Thickness	Number of Blades
JHWGS-2	Standard Feeler Gauge Set	.002 - .015	10

Features

- 10 blades 3" x 1/2" in the following thicknesses: .002, .003, .004, .005, .006, .007, .008, .010, .012, .015
- Both decimal and equivalent metric size etched in each blade
- Gauges supplied in holder with knurled lock-nut which allows the user to select the required blade size and lock it into position

Product Code	Description	Thickness	Number of Blades
JHWGS-3	Combination Feeler Gauge Set	.002 - .025	22

Features

- Contains total of 22 blades
- 10 blades 3" x 1/2" in the following thicknesses: .002, .003, .004, .005, .006, .007, .008, .010, .013, .015
- 12 blades 1-3/4" x 1/4" in the following thicknesses: .011, .012, .013, .014, .015, .016, .017, .018, .019, .020, .022, .025
- Overall length 5"
- Both decimal and equivalent metric size etched in each blade
- Gauges supplied in holder with knurled lock-nut which allows the user to select the required blade size and lock it into position

Product Code	Description	Thickness	Number of Blades
JHWGS-4	Piston Feeler Gauge Set	.002 - .015	8

Features

- 8 blades 9" x 1/2" in the following thicknesses: .002, .003, .004, .005, .006, .008, .010, .015
- Both decimal and equivalent metric size etched in each blade
- Gauges supplied in holder with knurled lock-nut which allows the user to select the required blade size and lock it into position

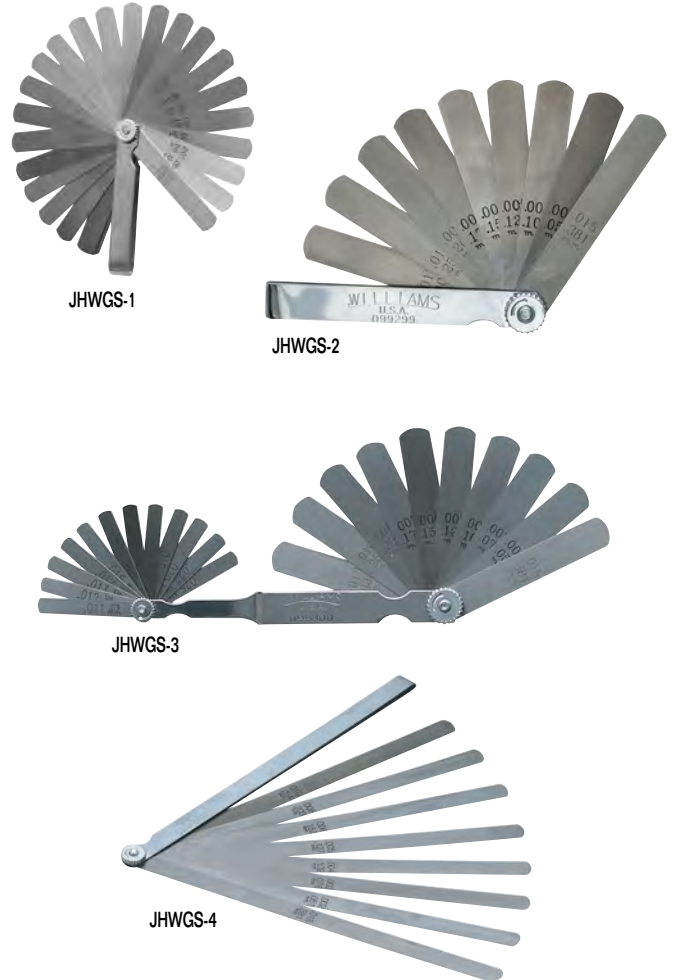



WBP500

BAHCO® PREMIUM WRECKING BARS WITH BENT AND FLAT END

Blunt Tip

Product Code	Overall Length (Inch)
WBP300	12
WBP500	20
WBP625	25
WBP710	28
WBP900	36

Features

- Octagonal bar
- 346 mm to 890 mm
- Steel SCM440
- Polished and given a grey coated
- Bent end and flat end
- Nail claw on one end especially designed for easy operation
- Uniform head treatment in the whole bar
- Uniform hardness: 49 HRC to 52.5 HRC

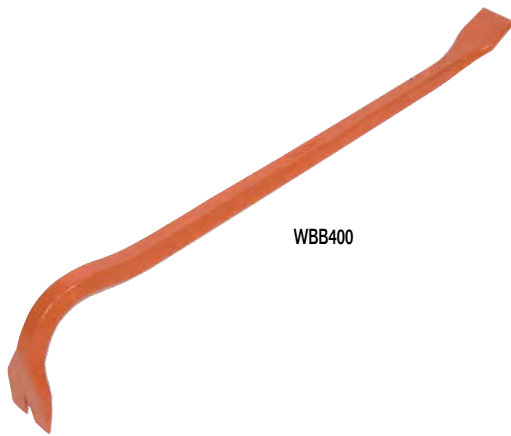

WBB400

BAHCO® WRECKING BARS WITH BENT AND FLAT END

Blunt Tip

Product Code	Overall Length (Inch)
WBB400	12
WBB500	21
WBB600	24
WBB700	28

Features

- Hexagonal bar
- Steel C45E body
- Fully painted in orange RAL2009
- Bent end and flat end body
- Heat treatment on the nail's areas
- Shaft hardness 25 HRC to 36 HRC, 45 HRC to 53 HRC in the nails



396-LAP



LAP-KNIFE



2444-LAP

BAHCO® LAPLANDER FOLDING SAW AND MULTIPURPOSE KNIFE

General Purpose Folding Saw

Product Code	Blade Length (Inch)	Teeth Per Inch
396-LAP	9	7

Multipurpose Knife

Product Code	Overall Length (Inch)
2444-LAP	9

Saw and Knife Set

Product Code	Description
LAP-KNIFE	Folding saw & Multipurpose Knife

Features

- A general purpose folding saw for cutting both green and dry wood, plastic, bone etc.
- Specially designed for wild-life enthusiasts, hunting and campers
- XT toothing, 7TPI
- Blade specially coated for rust protection and low friction
- Two-component plastic handle for perfect grip, with leather strap
- Safety lock, locked also when folded

BAHCO® RESCUE FLOATING KNIFE

Stainless Steel Blade

Product Code
1446-FLOAT

Features

- Floating knife with Stainless Steel blade and serrated cutting edge
- The knives helps to prevent high recovery cost when it is dropped in the water and helps to avoid plastic in the aquatic environment
- The knife is designed to float straight up for better visibility
- To increase visibility in darkness the handle and holster luminizes when using UV light
- The handle contains a hole to attached to a wrist strap or lanyard



1446-FLOAT

BAHCO® SAFETY KNIFE WITH STAINLESS STEEL BLADES

Blunt Tip

Product Code Overall Length (Inch)
2446-SAFE 8 1/2

Features

- Safety knife with blunt tip to avoid accidental injuries
- Comfortable two-component handle provides excellent grip
- Robust multipurpose knife with a solid stainless steel blade
- Supplied with a practical sheath for carrying on a belt
- Holster includes a double fix button for attaching a holster with second knife



2446-SAFE

BAHCO® CARPENTER'S MULTI-PURPOSE KNIFE WITH HOLSTER

With Holster

Product Code	Description	Length (Inches)
1446	Multi Purpose Knife with Holster	9
2444	Carpenter's Multi-Purpose Knife with Holster	9
2446	Multi Purpose Knife with Holster	9

Features

- Multi purpose knife with high quality steel and bi-component handle
- Polished stainless steel blade
- Two component handle for comfortable grip
- Knife comes in plastic case with belt clip
- Ideal for fishermen, hunters and for working in the garden



1446



2444



2446

BAHCO® WRECKING KNIFE

With Holster

Product Code	Description	Length (Inches)
2448	Wrecking Knife	9

Features

- The wrecking chisel knife has been designed to be used like a regular chisel or when turned sideways a 4in wide knife
- The blade is 4mm thick and made from hardened steel and can be used like a 4in chisel with a hammer on the back of the blade for added force
- The handle has a curved guard to protect the knuckles while in use and can also be used with a hammer
- The wrecking knife comes in handy for all those woodworking tasks
- The knife comes complete with a holster with button clip



2448



BAHCO® SPORTS KNIVES

Product Code	Description
KBTU-01	Knife with Twin Blade - Utility & Sports Blade
KBSK-01	Knife with 3 Inch Sport Blade-Only

Features

- Sports knives have an aluminum handle
- Stainless steel blade and mechanism
- Blade locks in position when fully unfolded
- Unlock button to avoid accidental folding



BAHCO® ERGO™ SNAP BLADE KNIFE

Product Code	Description
KB18-01	18mm Snap Off Knife TPR
KE18-01	ERGO® 18 mm Snap Off Knife
KSBG18-10D	Replacement Snap Blade - 10 pack

Features

- ABS body with comfortable TPR grip
- Blade storage in backside of the body
- Closed front of body to simplify blade snapping



BAHCO® SNAP BLADE KNIFE

Product Code	Description
KG09-01	9mm Snap Off Knife
KSBG09-10D	Replacement Snap Blade - 10 pack
KE18-01	ERGO® 18 mm Snap Blade Knife

Features

- ABS body smooth textured button
- Precise steel mechanism for distinct blade positioning



BAHCO® ERGO™ UTILITY KNIFE

Product Code	Description
KERU-01	ERGO® Retractable Utility Knife

Features

- Integrated button for smooth action and to shift blade in three distinct positions
- Curved handle for wide variety of grips
- Smart button to replace blades
- Narrow head for optimal visibility and precision
- Ideal angle for minimized muscle stress
- Optimized handle size and weight
- Smart button to store blades without opening the body



KNIVES
TOOLS FOR
THE TRADES

AUTOLOAD QUICK-BLADE UTILITY KNIFE

Includes Heavy-Duty .025" Thick 2-Notch Blades

Product Code	Description
JHW40052	Autoload Quick-Blade Utility Knife

Features

- Blade is easily removed or reversed from the front with push-button ease
- New blade is automatically loaded from 5-blade magazine
- Spring-loaded cover makes reloading quick and tool-free
- Includes (5) .025" blades



JHW40052

BAHCO® SQUEEZE GRIP SAFETY KNIFE

Bi-Mold Comfort Grip Handle

Product Code	Description
SQZ150003	Squeeze Grip Safety Knife
SQZ150003-HSBL	12 Pack Hook Blades
SQZ150005-SBL	12 Pack Standard Blades

Features

- Automatically loads new knife blade with the squeeze of the handle
- Quick release button to remove blade
- Comfort handle with thumb groove for greater control and comfort
- Extremely fast blade operation and change with side button for retraction and lower lever for extension
- Single button press for blade removal, squeeze lower lever for new blade
- Six spare blades stored in special compartment
- Includes: 6 heavy-duty blades



SQZ150003



Load blade with squeeze of handle



Retract blade with side button



Spare blades stored in special compartment



Single button press for blade removal



JHW40082

DISPOSABLE SAFETY CUTTER

Product Code	Description
JHW40082	Lightweight, ergonomic, ambidextrous disposable safety cutter

Features

- Retracting safety hooded guard prevents cuts
- NSF certified for food areas
- Safety point blade included standard
- Integrated tape splitter
- Stainless steel blade for hygiene
- 3-button mechanism for top and side cuts
- Applications: multi purpose cutting, food processing areas, cuts corrugate, cartons, taped boxes, film and shrink



JHW40084

DISPOSABLE FILM CUTTER

Product Code	Description
JHW40084	Durable plastic construction and a long-lasting super sharp blade

Features

- Suitable for use in food areas
- Integrated tape splitter
- Stainless steel blade for hygiene
- Applications: cuts tape, strapping, shrink wrap and film



JHWLLED-150

ALUMINUM PEN LIGHT

UV Spotlight

Product Code	Overall Length (inch)
JHWLLED-150	7

Features

- Premium slim aluminum design
- Compact size for easy carrying
- Built-in magnet on clip for hand free
- Main light provide 150lm output
- Spot light with UV LED for leak detection
- Micro-USB charge port
- Light in weight
- Design for mechanical

LED ROTATING WORKLIGHT

Product Code	Description
JHW5102	24 LED Rotating Magnetic Work light
JHW5103	48 LED Rotating Magnetic Work light

Features

- Rotating head allow directional positioning
- Powerful magnetic base for secure mounting
- Includes alkaline batteries
- 5103 is two times as bright as 5102



JHW5102



JHW5103

BAHCO® MAGNETIC PICK-UP TOOL WITH LIGHT

Product Code	Description	Extended Length (Inches)
2535L	Magnetic Pick-up Tool with Light	30

Features

- Wide area lighting
- Soft grip handle
- Powerful magnetic tip
- Pick-up weight is 1¼ pounds



2535L

FLEXIBLE SPRING CLAW

Product Code	# of Claws	Max Jaw Opening (inches)	Flexible Section length, inches	Overall Length (inches)
JHW40159	4	¾"	16"	23 ½"

Features

- Tightly wound, Flexible spring snakes into tight areas
- Four-jaw claw opens wide to secure hard to reach objects

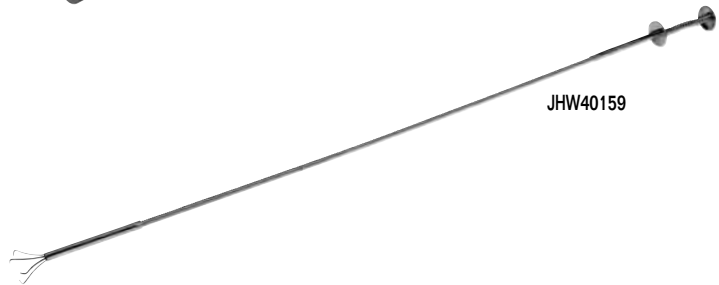

JHW40159

TELESCOPING MAGNETIC PICK UP TOOLS

Product Code	Lifts (lbs)	Overall Length (Inches)	Extends to
JHW40151	2 ½	6 5/8"	33 ¼"
JHW40152	5	6 5/8"	33 ¼"
JHW40153	10	8 ¼"	30 ¼"
JHW40154	2 ½	6 ½"	25 ½"
JHW40155	1 ½	5 5/8"	25 9/16"
JHW40155-30P	30 pack counter display		

Features

- Stainless Steel Shaft
- JHW40154 and JHW40155 Chrome Shaft
- Black cushion grip will not slip in oily or wet hands
- Powercap® shields sides of magnet for focused lifting
- Includes pocket clip



JHW40151



JHW40152



JHW40155

LED TELESCOPING MIRRORS

Product Code	Mirror Diameter	Overall Length (Inches)	Extends to
JHW40255	2 3/8"	6 1/2"	37"
JHW40256	2 1/4" x 3 1/2"	6 1/2"	30 1/4"

Features

- Stainless Steel Shaft
- Cushion grip will not slip in oily or wet hands
- Batteries included



JHW40255



JHW40256



JHW40252



JHW40253



JHW40254

TELESCOPING INSPECTION MIRRORS

Product Code	Mirror Diameter	Overall Length (Inches)	Extends to
JHW40252	1 1/4"	6 1/2"	35"
JHW40253	2 1/4"	6 1/2"	36 3/8"
JHW40254	3 1/4"	6 1/2"	29 1/2"

Features

- Stainless Steel Shaft
- Cushion grip will not slip in oily or wet hands

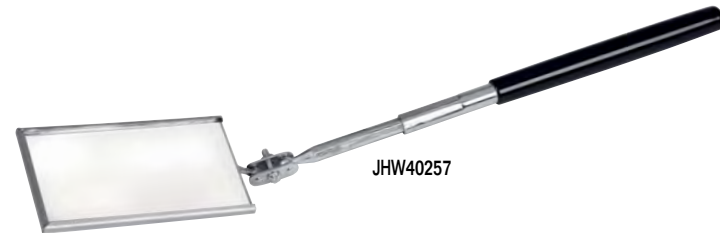

JHW40257

SWIVEL INSPECTION RECTANGULAR MIRROR

Product Code	Mirror Diameter	Overall Length (Inches)	Extends to
JHW40257	2 1/8" x 3 1/2"	11 1/4"	15 1/4"

Features

- Vinyl Grip
- Double ball joints allow mirror to swivel 360 degrees
- Glass Mirror
- Stainless Steel Mirror Back
- Non-rotating telescoping rods

BAHCO® NAIL PULLER/NAIL PUNCH

Nail Punch

Product Code	Description	Overall Length (Inches)
36	Nail Puller	9
SB-3732-2.5-1.25	Nail Punch	5

Features

- For fast easy removal of nails
- Black Industrial Finish
- Comfortable non-slip thermoplastic grip handle
- Patented internal spring to keep the jaws open
- Wide striking area
- To be used with a claw hammer



BAHCO® GENERAL PURPOSE GLOVES

Product Code	Size
GL008-10US	Large

Features

- General purpose work gloves
- A thin PU material gives that user better touch and feel



INSULATED TOOLS

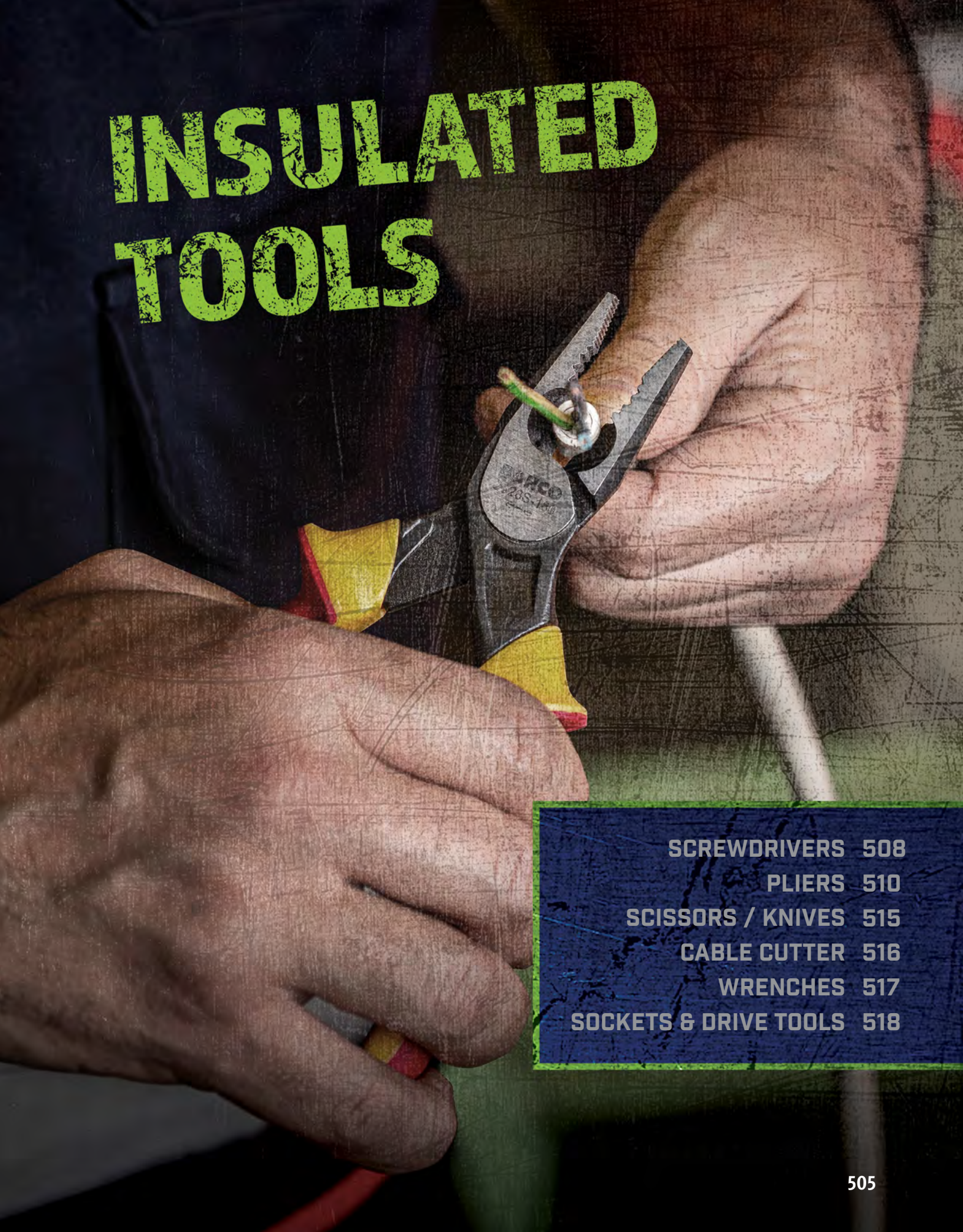

SCREWDRIVERS	508
PLIERS	510
SCISSORS / KNIVES	515
CABLE CUTTER	516
WRENCHES	517
SOCKETS & DRIVE TOOLS	518



Quality guarantee

Bahco is one of the few hand-tool manufacturers that make the tools and the insulation in-house. Both the PVC dipped insulated version (most of the tools) and the handle version (pliers and screwdrivers) are manufactured entirely in Bahco factories.

Each tool is tested to 10,000 V for a period of 10 seconds to provide a high level of protection during live work.

Bahco's three-layer insulated tools have a color coded, multi layer insulation coating. This provides protection as well as creating a visual warning system. If the outer insulation layer gets damaged, the lighter color underneath will become visible and warn the user. This makes it easier to detect damage to the insulation.



Routine tests in accordance with IEC60900 specification

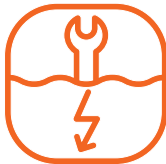

Dielectric test

The tools are immersed in water for 24 hours. A voltage of 10 kV is then continuously applied for 3 minutes. The test is considered successful if no electrical puncture, spark over, or flashover occurs during the test period. Leakage limits must not be exceeded.

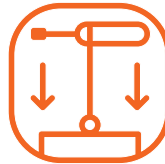

Retaining force test

This test is applied to tools that can be assembled. A force is applied to the assembled parts in an effort to separate them. If, after a minute, the parts remain assembled, the test is passed.



Impact test

The tools are cooled to -25°C for 2 hours. Then, a special hammer is used with some force on the insulating layer. The test is considered successful if the insulating material shows no breaks and passes the dielectric test.



Permanent marking durability

The markings are rubbed for 15 seconds with a rag soaked in water, and then for 15 seconds with a rag soaked in isopropanol. The test is passed if, after this process, the markings are still legible.

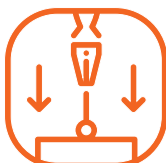

Insulation adhesion test

The tools are stored at a temperature of 70°C for 168 hours. Then, a force of 490 N is applied in the direction of the line dividing the insulating material from the conductive part for 3 minutes. During this test the insulation material must stay firmly attached to the tools.



Penetration test

The insulated surfaces of the tools are pressed with a special device. A voltage of 5000 V is then applied to the tool for 3 minutes. The test is considered successful if no electrical puncture, spark-over, or flash-over occurs during the test period.



Flame test

When placed over a fire, where the height of the flames on the tools does not exceed 120 mm, if the insulation material does not melt or leak, then the test is passed.



Visual and dimensional

The tools, and in particular the insulation, are visually controlled and have to be free from external defects. The markings have to be perfectly legible and the dimensions have to be in accordance with the standard.

INSULATED TOOLS

1000V ERGO™ SLOTTED SCREWDRIVERS

YOUR SAFETY IS OUR HIGHEST PRIORITY

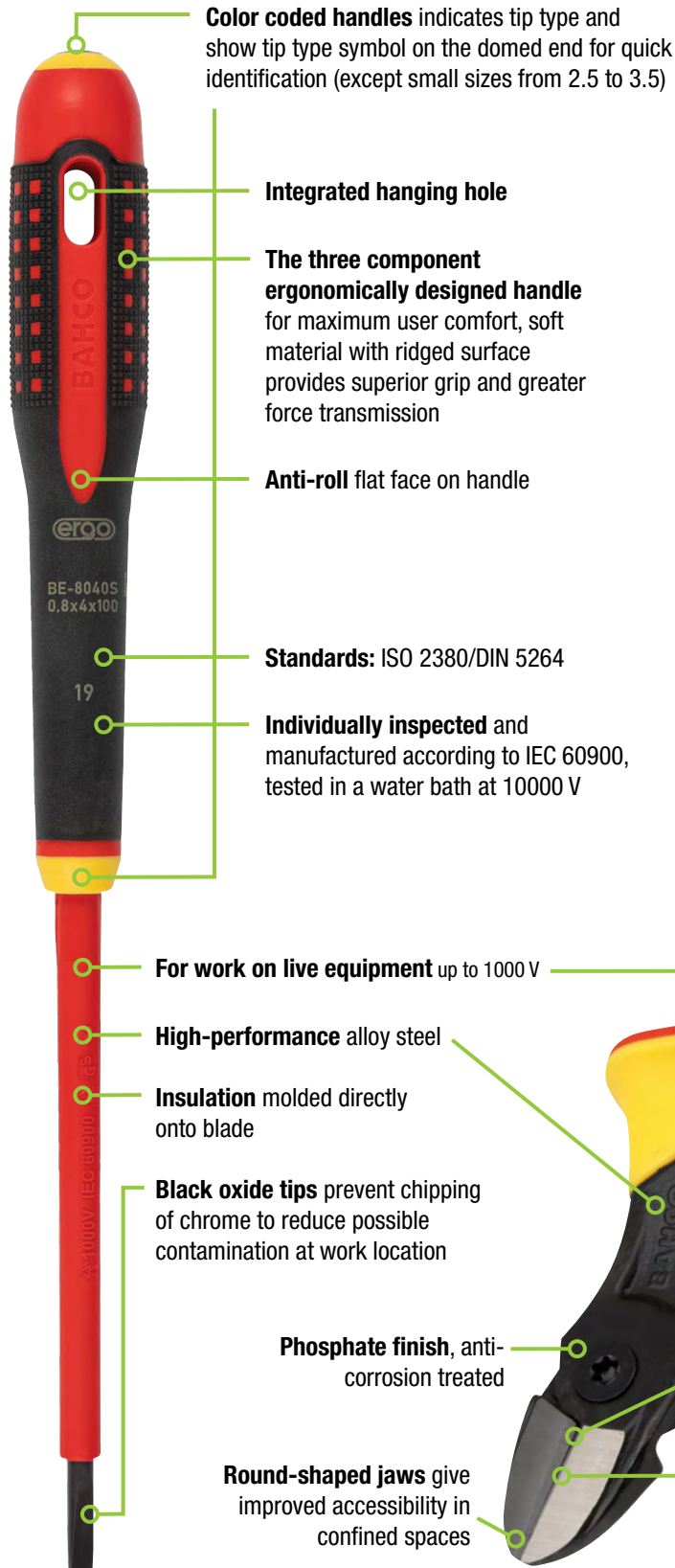

1000V ERGO™ DIAGONAL CUTTING PLIERS

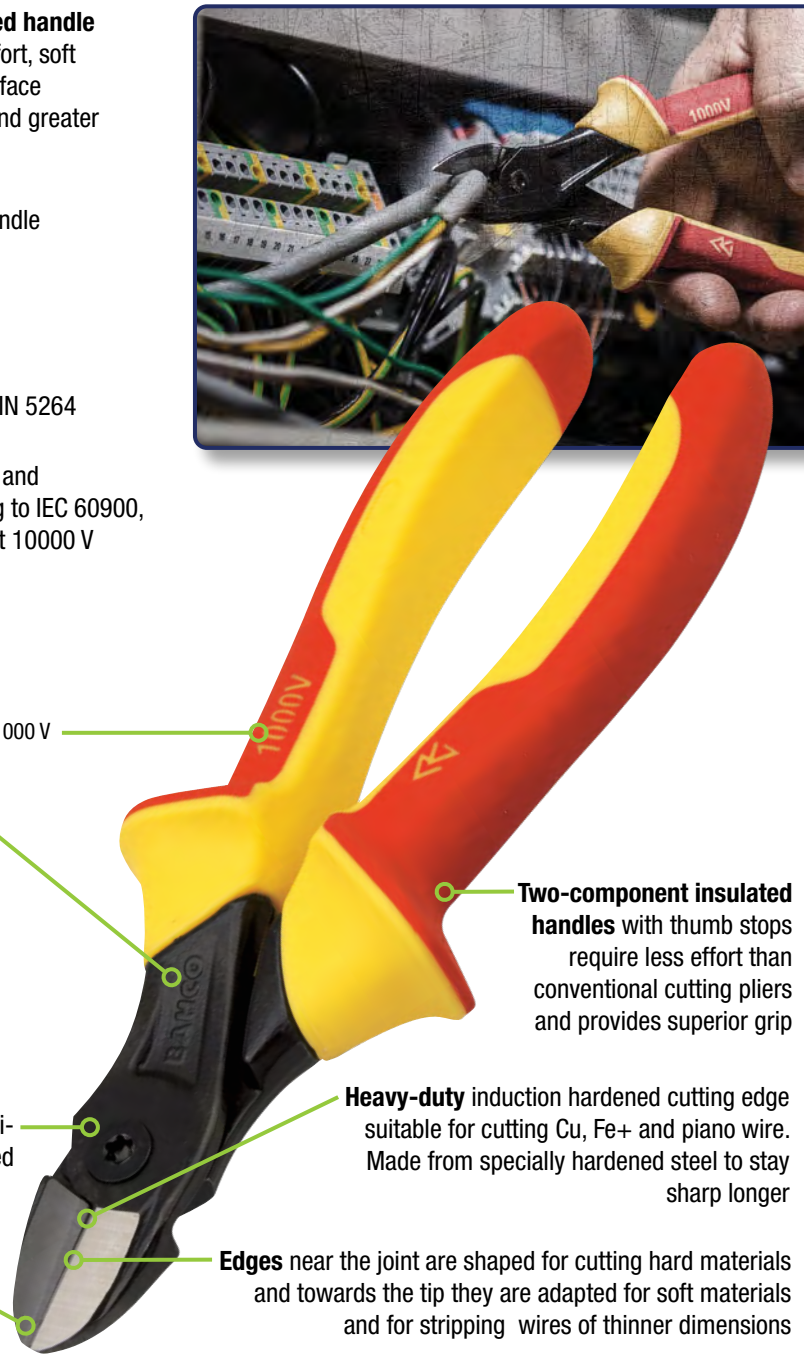

BAHCO® 7 PIECE INSULATED RATCHETING SCREWDRIVER SETS



A must have tool for electricians.

Product Code	Style	Blade Tip Sizes Included
808061	Phillips® and Slotted Blades	PH1, PH2, 0.4 x 2.5, 0.5 x 3.0, 0.8 x 4.0, 1.0 x 5.5, Handle
808062	Pozidriv® and Slotted Blades	PZ1, PZ2, 0.4 x 2.5, 0.5 x 3.0, 0.8 x 4.0, 1.0 x 5.5, Handle

Features

- The blade release system built in the comfortable handle makes it easy and safe to change the slim blades without the blades falling out
- The blades are 30% slimmer than the blade of a regular insulated screwdriver for better accessibility and more applications such as sunken screws and spring elements
- For working on live equipment up to 1000 volts
- Complete with roll up pouch with clear 1000v indication
- IEC 60900 compliant

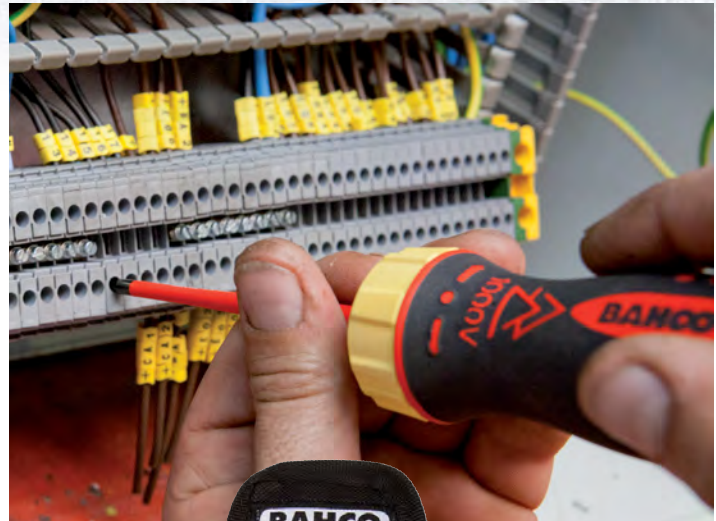

808061

The blade release system built in the comfortable handle makes it easy and safe to change the slim blades without the blades falling out. The blades are 30% slimmer than the blade of a regular insulated screwdriver for better accessibility and more applications (e.g. sunken screws and spring elements). A must have tool for electricians.

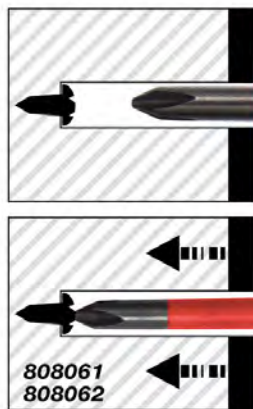

RATCHETING

The handle has a 48 tooth non-conductive ratcheting mechanism.





BE-9881S



BE-8040S

BE-8621S

BE-8220S

BAHCO® ERGO™ 1000V SCREWDRIVERS

- For work on live equipment up to 1000 volts
- The three component ergonomically designed handle provides comfort and maximum grip even with oily hands
- Color coded handles indicate tip type. Tip type symbol is also printed on bottom of handle for quick identification
- Chrome blades prevent corrosion and can be easily cleaned
- Black oxide tips prevent chipping of chrome to reduce possible contamination at work location

BAHCO® ERGO™ 5 PIECE 1000V SCREWDRIVER SET



Three Component Handle with Black Oxide Tips

Product Code	Description
BE-9881S	5 Piece ERGO™ Screwdriver Set Phillips® / Slotted

Contents Include:

Product Code	Overall Length (Inches)	Blade Length (Inches)	Tip Width /Point Size
BE-8220S	9	4	1/8
BE-8040S	8 3/4	4	5/32
BE-8050S	8 3/4	4	7/32
BE-8610S	8	3 3/32	#1
BE-8620S	8 3/4	4	#2

Features

- Contains 3 slotted and 2 Phillips® screwdrivers



BAHCO® ERGO™ 1000V SLOTTED SCREWDRIVERS



Three Component Handle with Black Oxide Tips

Product Code	Overall Length (Inches)	Blade Length (Inches)	Tip Width (Inches)
BE-8010S	8	3	3/32
BE-8220S	8 3/4	4	1/8
BE-8230S	9 3/4	5	9/64
BE-8040S	8 3/4	4	5/32
BE-8050S	9 3/4	5	7/32
BE-8255S	10 3/4	6	1/4
BE-8065S	11 3/4	7	5/16



BAHCO® ERGO™ 1000V PHILLIPS® SCREWDRIVERS



Three Component Handle with Black Oxide Tips

Product Code	Overall Length (Inches)	Blade Length (Inches)	Point Size
BE-8600S	6 3/8	2 3/8	0
BE-8610S	8	3 5/32	1
BE-8620S	8 3/4	4	2
BE-8630S	10 3/4	6	3
BE-8640S **	14 1/4	8	4

** Dual grip handle for two-handed operation provides extra torque when necessary



2 PLIERS IN 1

The ERGO™ side cutting pliers have a progressive edge. Effectively, this means you can cut soft, thin wire close to the tip, and hard wire close to the screw. At the tip, the cutting edge is sharper so that it can cut softer materials such as copper, instead of simply squeezing them like most of the heavy duty pliers would.

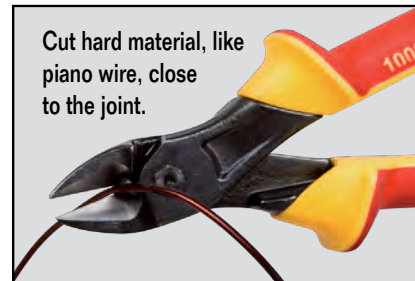

BAHCO® ERGO™ 1000V SIDE CUTTING PLIERS WITH PROGRESSIVE EDGE

For working on live equipment up to 1000 volts

Product Code	Overall Length (Inches)	Jaw Length (Inches)	Max Cutting Capacity (Inches)
2101S-140	5 1/2	5/8	1/16 Piano Wire
2101S-160	6 1/2	3/4	1/16 Piano Wire
2101S-180	7	13/16	5/64 Piano Wire

Features

- Two-component ERGO™ insulated handles: thermoplastic surface on tough polypropylene provides superior grip
- Suitable for cutting Cu, Fe+ and piano wire
- Insulated side cutting pliers developed according to the scientific ERGO™ process for working on live equipment up to 1000V
- Distance from joint to center of cutting edges is reduced for greater leverage and increased cutting capacity
- Cutting radius progresses along edge in order to cut hard material such as piano wire close to the joint as well as soft materials
- Screw joint provides excellent running and accurate alignment of cutting edges
- Round-shaped jaws give improved accessibility in confined spaces
- Less effort required compared to conventional cutting pliers
- Reduced shank width ideally for carrying in the pocket



2101S-180





2223S-150

BAHCO® ERGO™ 1000V WIRE STRIPPING PLIERS

For working on live equipment up to 1000 volts

Product Code	Overall Length (Inches)	Jaw Length (Inches)
2223S-150	5 3/4	1 1/8

Features

- Two-component ERGO™ insulated handles: thermoplastic surface on tough polypropylene base provides superior grip
- Developed according to the scientific ERGO™ process
- For working on live equipment up to 1000 V in compliance with IEC 60900
- Stripping capacity: 0.5 mm to 5 mm
- Easy wire cutting and stripping pliers for copper and aluminum
- For stripping copper wire up to 5 mm
- High-performance alloy steel
- Phosphate finish, anti-corrosion treated
- Standards: IEC 60900
- Every tool is tested at 10,000 V for 10 seconds at the end of the manufacturing process



2421S-160

BAHCO® ERGO™ 1000V FLAT NOSE PLIERS

For working on live equipment up to 1000 volts

Product Code	Overall Length (Inches)	Jaw Length (Inches)
2421S-140	5 1/2	1 1/4
2421S-160	6 1/4	2
2421S-180	7	2 1/4

Features

- Two-component ERGO™ insulated handles: thermoplastic surface on tough polypropylene base provides superior grip
- Developed according to the scientific ERGO™ process
- For working on live equipment up to 1000 V in compliance with IEC 60900
- Tips provide good grip and improved accessibility in confined spaces
- Particularly designed for gripping flat material
- High-performance alloy steel
- Phosphate finish, anti-corrosion treated
- Standards: ISO 5745, IEC 60900



BAHCO® ERGO™ 1000V 45° CURVED NOSE PLIERS

For working on live equipment up to 1000 volts

Product Code	Overall Length (Inches)	Jaw Length (Inches)	Max Cutting Capacity (Inches)
2427S-160	6 1/4	1 13/16	5/64 Hard Steel
2427S-200	7	2 3/4	5/64 Hard Steel

Features

- Two-component ERGO™ insulated handles: thermoplastic surface on tough polypropylene base provides superior grip
- Developed according to the scientific ERGO™ process
- For working on live equipment up to 1000 V in compliance with IEC 60900
- Cutting capacity: 2.5 mm to 3 mm copper, 1.8 mm iron, 1.4 mm to 1.6 mm iron alloy
- Half-round serrated jaws for gripping flat and round material with great accessibility in confined spaces
- Bent jaws with hardened cutting edges for cutting soft and hard wire
- High-performance alloy steel
- Phosphate finish, anti-corrosion treated
- Standards: ISO 5745, IEC 60900



2427S-200

BAHCO® ERGO™ 1000V LONG NOSE PLIERS

For working on live equipment up to 1000 volts

Product Code	Overall Length (Inches)	Jaw Length (Inches)	Max Cutting Capacity (Inches)
2430S-140	5 1/2	1 1/4	1/16 Hard Steel
2430S-160	6 1/4	1 5/16	1/16 Hard Steel
2430S-200	7	2 3/4	5/64 Hard Steel

Features

- Two-component ERGO™ insulated handles: thermoplastic surface on tough polypropylene base provides superior grip
- Developed according to the scientific ERGO™ process
- For working on live equipment up to 1000 V in compliance with IEC 60900
- Cutting capacity: 2.5 mm to 3 mm copper, 1.8 mm iron, 1.4 mm to 1.6 mm iron alloy
- Half-round serrated jaws for gripping flat and round material with great accessibility in confined spaces
- Straight jaws with hardened cutting edges for cutting soft and hard wire
- High-performance alloy steel
- Phosphate finish, anti-corrosion treated
- Standards: ISO 5745, IEC 60900



2430S-200



2521S-160

BAHCO® ERGO™ 1000V 45° ROUND NOSE PLIERS

For working on live equipment up to 1000 volts

Product Code	Overall Length (Inches)	Jaw Length (Inches)
2521S-140	5 1/2	1 1/8
2521S-160	6 1/4	1 1/4

Features

- Two-component ERGO™ insulated handles: thermoplastic surface on tough polypropylene base provides superior grip
- Developed according to the scientific ERGO™ process
- For working on live equipment up to 1000 V in compliance with IEC 60900
- Round thin tips for improved accessibility
- Specifically designed for wire bending
- High-performance alloy steel
- Phosphate finish, anti-corrosion treated
- Standards: ISO 5745, IEC 60900
- Every tool is tested at 10,000 V for 10 seconds at the end of the manufacturing process



2628S-180

BAHCO® ERGO™ 1000V COMBINATION PLIERS

For working on live equipment up to 1000 volts

Product Code	Overall Length (Inches)	Jaw Length (Inches)	Max Cutting Capacity (Inches)
2628S-160	6 1/4	1 5/16	1/16 Hard Steel
2628S-180	7	1 7/16	5/64 Hard Steel
2628S-200	8	1 1/2	7/64 Hard Steel

Features

- Two-component ERGO™ insulated handles: thermoplastic surface on tough polypropylene base provides superior grip
- Developed according to the scientific ERGO™ process
- For working on live equipment up to 1000 V in compliance with IEC 60900
- Gripping surfaces particularly suited for flat and round material
- Special head design for better accessibility, with hardened cutting edges for cutting soft and hard wire
- High-performance alloy steel
- Phosphate finish, anti-corrosion treated
- Standards: ISO 5746, IEC 60900



BAHCO® 1000V QUICK ADJUST WATER PUMP PLIERS

For working on live equipment up to 1000 volts

Product Code	Overall Length (Inches)	Jaw Length (Inches)	Tip Width (Inches)
7224S	10	2	5/8

Features

- 1000V quick-adjust water pump pliers
- Sturdy box joint frame and slim design
- High performance alloy steel, two-component handles for maximum grip comfort
- Phosphate finish, anti-corrosion treated
- Self-adjusting patented lateral lever
- Flat and round grip shape with auto-tightening device
- Up to 35% bigger mouth opening compared to market standard
- Narrow design head for great accessibility in confined spaces
- Hardened teeth (60 HRC to 62 HRC) for a long product life and strong gripping on any shape
- Slim jaws provide easy accessibility
- Designed to prevent fingers being pinched
- ISO 8976, IEC 60900



7224S





SC127V



SC150NGV

BAHCO® 1000V ELECTRICIAN SCISSORS

For protection against inadvertent shock when working on circuits up to 1000 volts

Product Code	Length (inches)
SC127V	5

Features

- Single layer coating (only red coating).
- Small groove in the blade for stripping cables.
- 2" cutting length.
- Guard to avoid fingers touching the metallic part by mistake.

Product Code	Length (inches)
SC150NGV	6

Features

- 2 layer coating: Red: safety, Yellow: danger
- Finger stops in both legs to avoid fingers touching the metallic part by mistake
- The longer handle allows to apply less force to cut a certain wire
- 1-1/2" cutting length



2820VP



2820VPC



2820VHELP



2820VTEE

BAHCO® 1000V ELECTRICIAN KNIVES

For protection against inadvertent shock when working on circuits up to 1000 volts

Product Code	Description
2820VP	Knife with Straight Blade
2820VPC	Knife with Curved Blade

Features

- 3 layer coating insulation with different colors plus a 4th one in black to further protect handle edges. Red: safety. Orange: danger. Yellow: high danger
- Available in straight and curved blade versions

Product Code	Description
2820VHELP	Knife with Guide

Features

- Insulated 1000 V knife with guide
- Single layer, injection molded, with protection cap
- Special blade with cable guard show for cable dismantling
- Stainless steel blade; handle shock resistant plastic



BAHCO® 1000 V TWEEZERS

For protection against inadvertent shock when working on circuits up to 1000 volts

Product Code
2820VTEE

Features

- Double layer coating - red layer indicates safety, yellow layer indicates danger, plus a 3rd one in black to further protect handle edges



BAHCO® 1000V CABLE CUTTER

With Insulated Grips

Product Code	Overall Length (Inches)	Cable Cutting Capacity (Inches) / Description	Replacement Blade Kit
2520S	23 5/8	1 3/16 Aluminum/Copper without Messenger Wire	2520-SH

Features

- For cuts on ferrous material, only use cutting notch that is provided below top cutting blades in jaws
- Extra thick grip handles on insulated cutter provides protection up to 1000 volts



2520S

BAHCO® 1000V RATCHET ACTION CABLE CUTTER

For protection against inadvertent shock when working on circuits up to 1000 volts

Product Code	Length (Inches)	Cutting Capacity (Inches)
2806-35V	9	1 1/2
2806-52V	13	2

Features

- 3 layer coating insulation with different colors plus a 4th one in black to further protect handle edges. Red: safety. Orange: danger. Yellow: high danger
- One hand operation, easy release of the movable jaw
- For cutting copper and aluminum cables
- Not suitable for hard copper, steel cables, or internal steel wire cables
- Clean and smooth cut without distortion



2806-35V



3-LAYER SAFETY COATING

BAHCO® 1000V BOLT CUTTER

For protection against inadvertent shock when working on circuits up to 1000 volts

Product Code	Length (Inches)	Wire types Ø mm w		
		80kg/mm ²	120kg/mm ²	160kg/mm ²
2820VBC	25	9	8	7

Features

- 3 layer coating insulation with different colors plus a 4th one in black to further protect handle edges. Red: safety. Orange: danger. Yellow: high danger
- Forged head; Induction hardened cutting edges
- Long arms with lever-action head, allows cutting of hard wires with very little effort



2820VBC



3-LAYER SAFETY COATING

BAHCO® 1000V ADJUSTABLE WRENCHES

For protection against inadvertent shock when working on circuits up to 1000 volts

Product Code	Length (inches)	Max Jaw Opening (Inches)	Head Thickness (Inches)
8070V	6	3/4	7/16
8071V	8	1 1/16	1/2
8072V	10	1 3/16	5/8
8073V	12	1 5/16	3/4
8074V	15	1 3/4	15/16

Features

- 3 layer coating insulation with different colors plus a 4th one in black to further protect handle edges. Red: safety. Orange: Caution. Yellow: danger
- Material: Chrome-Vanadium steel
- The movable jaw slides easily by smoothly operating the thumb screw
- Complies with ISO and ANSI torque requirements
- Head dimensions comply with ISO 6787 standards



8071V

BAHCO® 1000V OPEN END WRENCH - METRIC

For protection against inadvertent shock when working on circuits up to 1000 volts

Product Code	Size (mm)	Overall Length (Inches)	Open End Width (Inches)	Open End Thickness (Inches)	Layers Coating
6MV6	6	3 5/8	9/16	1/8	2
6MV7	7	3 5/8	1 1/16	1/8	2
6MV8	8	3 5/8	1 1/16	3/16	2
6MV9	9	3 7/8	1 3/16	3/16	2
6MV10	10	4 1/4	1 5/16	3/16	2
6MV11	11	4 9/16	1	3/16	2
6MV12	12	5	1 1/8	3/16	2
6MV13	13	5 5/16	1 1/4	3/16	2
6MV14	14	5 1/2	1 1/4	1/4	2
6MV15	15	6	1 1/4	1/4	2
6MV16	16	6 3/16	1 1/4	1/4	2
6MV17	17	6 3/8	1 7/16	1/4	3
6MV18	18	6 3/8	1 9/16	1/4	3
6MV19	19	6 7/8	1 5/8	1/4	3

Features

- 2 layer coating insulation with different colors plus a 3rd one in black to further protect handle edges on spanners from 6 mm to 16 mm. Red: safety. Yellow: danger
- 3 layer coating insulation with different colors plus a 4th one in black to further protect handle edges on spanners from 17 mm to 32 mm. Red: safety. Orange: danger. Yellow: high danger
- Material: Chrome-Vanadium steel
- Opening tolerance according to ISO 691



6MV

BAHCO® VOLTAGE TESTER

Clear transparent plastic hand, impact resistant

Product Code	Overall Length (Inches)	Blade Length (Inches)	Size (Inches)
806-1-1	6	3 1/2	1/8

Features

- Mains tester 150-250V
- Handle is clear transparent plastic handle, impact resistant
- Blade is high quality steel, Nickel plated blade. Plastic protection up to the tip



806-1-1

BAHCO® 1000V 1/2" RATCHET

For protection against inadvertent shock when working on circuits up to 1000 volts

Product Code	Length (Inches)	Head Width A (Inches)	Head Thickness B (Inches)	Drive Size C (Inches)
8150-1/2V	10 1/2	3	2	1/2

Features

- 3 layer coating insulation with different colors plus a 4th one in black to further protect handle edges. Red: safety. Orange: danger. Yellow: high danger
- Material: Chrome-Vanadium steel
- One of the buttons is a lever to change the ratcheting direction; the other is a push button to lock or release the socket to the male square drive
- 28 teeth ratchet to operate at a 13° angle
- Static and endurance tests with 50,000 cycles
- Complies with the ISO standards



8150-1/2V

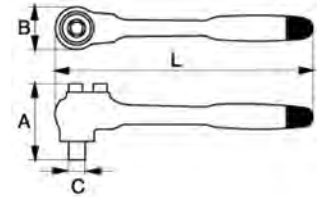

BAHCO® 1000V 1/2" EXTENSION

For protection against inadvertent shock when working on circuits up to 1000 volts

Product Code	Length (Inches)
8160-1/2V	5

Features

- 2 layer coating insulation with different colors. Red: safety. Yellow: danger
- Material: Chrome-Vanadium steel
- The male square drive is having a slotted screw to move the ball outward or inward and block or unblock the socket to it
- The male square tolerances and torque requirements comply with the respective ISO standard



8160-1/2V

BAHCO® 1000V 1/2" DRIVE SOCKETS - METRIC



For protection against inadvertent shock when working on circuits up to 1000 volts

Product Code	Size (mm)	Overall Length (Inches)	Drive End Diameter (Inches)	Working End Diameter (Inches)	Nose Length (Inches)
7800DMV-8	8	2	7/8	3/8	1/4
7800DMV-10	10	2	7/8	3/4	1/4
7800DMV-11	11	2	7/8	3/4	1/4
7800DMV-12	12	2	7/8	3/4	1/4
7800DMV-13	13	2	7/8	1	1/4
7800DMV-14	14	2	7/8	1	3/8
7800DMV-15	15	2	7/8	1	3/8
7800DMV-16	16	2	7/8	1	3/8
7800DMV-17	17	2	7/8	1 1/8	3/8
7800DMV-18	18	2	7/8	1 1/8	1/2
7800DMV-19	19	2	7/8	1 3/16	1/2

Features

- 2 layer coating insulation with different colors
- Material: Chrome-Vanadium steel
- 12 point Dynamic Drive Profile
- Both square and 12 point openings according to the tolerance and torque requirements given in ISO standards



7800DMV

INCH	DECIMAL	MILLIMETER	MILLIMETERS	INCHES	MILLIMETERS	INCHES	FOOT POUNDS	NEWTON METERS	FOOT POUNDS	NEWTON METERS
1/64	.0156	0.397	26	1.0236	94	3.7008	18	24.4	85	115.2
1/32	.0312	0.794	27	1.0630	95	3.7402	19	25.8	86	116.6
	.0394	1.000	28	1.1024	96	3.7795	20	27.1	87	117.9
3/64	.0469	1.191	29	1.1417	97	3.8189	21	28.4	88	119.3
1/16	.0625	1.587	30	1.1811	98	3.8583	22	29.8	89	120.7
5/64	.0781	1.984	31	1.2205	99	3.8976	23	31.2	90	122.0
	.0787	2.000	32	1.2598	100	3.9370	24	32.5	91	123.4
3/32	.0937	2.381	33	1.2992	110	4.3307	25	33.9	92	124.7
7/64	.1094	2.778	34	1.3386	120	4.7244	26	35.3	93	126.0
	.1181	3.000	35	1.3780	130	5.1181	27	36.6	94	127.4
1/8	.1250	3.175	36	1.4173	140	5.5118	28	38.0	95	128.8
9/64	.1406	3.572	37	1.4567	150	5.9055	29	39.3	96	130.2
5/32	.1562	3.969	38	1.4961	160	6.2992	30	40.7	97	131.5
	.1575	4.000	39	1.5354	200	7.8740	31	42.0	98	132.9
11/64	.1719	4.366	40	1.5748	300	11.8110	32	43.4	99	134.2
3/16	.1875	4.762	41	1.6142	400	15.7480	33	44.7	100	135.6
	.1968	5.000	42	1.6535	500	19.6850	34	46.1	110	149.0
13/64	.2031	5.159	43	1.6929	600	23.6220	35	47.5	115	156.0
7/32	.2187	5.556	44	1.7323	700	27.5591	36	48.8	120	163.0
15/64	.2344	5.953	45	1.7717	800	31.4961	37	50.2	125	170.0
	.2362	6.000	46	1.8110	900	35.4331	38	51.5	130	176.0
1/4	.2500	6.350	47	1.8504	1000	39.3701	39	52.9	135	183.0
17/64	.2656	6.747	48	1.8898			40	54.2	140	190.0
	.2756	7.000	49	1.9291			41	55.6	145	197.0
9/32	.2812	7.144	50	1.9685			42	56.9	150	203.0
19/64	.2969	7.541	51	2.0079			43	58.3	155	210.0
5/16	.3125	7.937	52	2.0472			44	59.7	160	217.0
	.3150	8.000	53	2.0866			45	61.0	165	224.0
21/64	.3281	8.334	54	2.1260			46	62.4	170	231.0
11/32	.3437	8.731	55	2.1654			47	63.7	175	237.0
	.3543	9.000	56	2.2047			48	65.0	180	244.0
23/64	.3594	9.128	57	2.2441			49	66.4	185	251.0
3/8	.3750	9.525	58	2.2835			50	67.8	190	258.0
25/64	.3906	9.922	59	2.3228			51	69.1	195	264.0
	.3937	10.000	60	2.3622			52	70.5	200	271.0
13/32	.4062	10.319	61	2.4016			53	71.9	205	278.0
27/64	.4219	10.716	62	2.4409			54	73.2	210	285.0
	.4331	11.000	63	2.4803			55	74.6	215	292.0
7/16	.4375	11.112	64	2.5197			56	75.9	220	299.0
29/64	.4531	11.509	65	2.5591			57	77.3	225	306.0
15/32	.4687	11.906	66	2.5984			58	78.6	230	313.0
	.4724	12.000	67	2.6378			59	80.0	235	320.0
31/64	.4844	12.303	68	2.6772			60	81.3	240	327.0
1/2	.5000	12.700	69	2.7165			61	82.7	245	334.0
	.5118	13.000	70	2.7559			62	84.0	250	341.0
33/64	.5156	13.097	71	2.7953			63	85.4	255	348.0
17/32	.5312	13.494	72	2.8346			64	86.8	260	355.0
35/64	.5469	13.891	73	2.8740			65	88.1	265	362.0
	.5512	14.000	74	2.9134			66	89.5	270	369.0
9/16	.5625	14.287	75	2.9528			67	90.8	275	376.0
37/64	.5781	14.684	76	2.9921			68	92.2	280	383.0
	.5906	15.000	77	3.0315			69	93.5	285	390.0
19/32	.5937	15.081	78	3.0709			70	94.9	290	397.0
39/64	.6094	15.478	79	3.1102			71	96.3	295	404.0
5/8	.6250	15.875	80	3.1496			72	97.6	300	411.0
	.6299	16.000	81	3.1890			73	99.0	305	418.0
41/64	.6406	16.272	82	3.2283			74	100.3	310	425.0
21/32	.6562	16.669	83	3.2677			75	101.7	315	432.0
	.6693	17.000	84	3.3071			76	103.0	320	439.0
43/64	.6719	17.066	85	3.3465			77	104.4	325	446.0
11/16	.6875	17.462	86	3.3858			78	105.8	330	453.0
45/64	.7031	17.859	87	3.4252			79	107.1	335	460.0
	.7087	18.000	88	3.4646			80	108.5	340	467.0
23/32	.7187	18.256	89	3.5039			81	109.8	345	474.0
47/64	.7344	18.653	90	3.5433			82	111.2	350	481.0
	.7480	19.000	91	3.5827			83	112.5	355	488.0
3/4	.7500	19.050	92	3.6220			84	113.9	360	495.0
49/64	.7656	19.447	93	3.6614						
25/32	.7812	19.844								
	.7874	20.000								
51/64	.7969	20.241								
13/16	.8125	20.637								
	.8268	21.000								
53/64	.8281	21.034								
27/32	.8437	21.431								
55/64	.8594	21.828								
	.8661	22.000								
7/8	.8750	22.225								
57/64	.8906	22.622								
	.9055	23.000								
29/32	.9062	23.019								
59/64	.9219	23.416								
15/16	.9375	23.812								
	.9449	24.000								
61/64	.9531	24.209								
31/32	.9687	24.606								
	.9843	25.000								
63/64	.9844	25.003								
	1.0000	25.400								

INCH POUNDS	NEWTON METERS
5	0.565
10	1.13
15	1.70
20	2.26
25	2.83
30	3.39
35	3.96
40	4.52
45	5.09
50	5.65
60	6.78
70	7.91
80	9.04
90	10.17
100	11.3
110	12.4
120	13.6
130	14.7
140	15.8
150	17.0
160	18.1
170	19.2
180	20.3
190	21.5
200	22.6

FOOT POUNDS	NEWTON METERS
1	1.356
2	2.7
3	4.0
4	5.4
5	6.8
6	8.1
7	9.5
8	10.8
9	12.2
10	13.5
11	14.9
12	16.3
13	17.6
14	18.9
15	20.3
16	21.7
17	23.0

HEX SOCKET CONVERSIONS	
10mm=0.394"	
11mm=0.433"	
12mm=0.472"	
13mm=0.512"	
14mm=0.551"	
15mm=0.591"	
16mm=0.630"	
17mm=0.669"	
18mm=0.704"	
19mm=0.748"	
20mm=0.787"	
21mm=0.827"	

Inch Lbs. x 0.113=Nm; Nm x 8.849=Inch Lbs.; Ft. Lbs x 1.356=Nm; Nm x 0.737=Ft. Lbs.			
---	--	--	--

Important Words About Safety for Users and Bystanders

Following these basic safety rules is a good start toward protecting yourself — and others in the vicinity — from injury while using tools.

- Wear safety goggles
- Use the right tool
- Use the tool properly
- Maintain the tool regularly
- Keep tools away from children
- Do not use tools on live electrical circuits unless specifically designed for such use
- Read and follow instructions

- * THIS SYMBOL INDICATES PROHIBITED ACTION
- DO NOT OVER-TORQUE NO PIPES OR LEVER EXTENSIONS
- NO HAMMERING
- NO PRYING
- DO NOT STRIKE HARD OBJECTS
- NO IMPACT/POWER DRIVE
- DO NOT STEP IN OR ON DRAWERS
- DO NOT OPEN MULTIPLE DRAWERS
- DO NOT PULL TO MOVE
- KEEP CHILDREN AWAY

- * THIS SYMBOL INDICATES MANDATORY ACTION
- * MANDATORY EAR PROTECTION
- * MANDATORY FACE SHIELD
- * MANDATORY MASK
- * MANDATORY RESPIRATOR
- * MANDATORY PROTECTIVE CLOTHING
- * MANDATORY PROTECTIVE GLOVES
- * MANDATORY EYE PROTECTION
- * MUST READ INSTRUCTIONS BEFORE USE

- WARNING**
- THIS SYMBOL INDICATES A HAZARD ALERT, GENERAL WARNING SIGN
- VIBRATION HAZARD
 - RISK OF EXPLOSION
 - OVERHEAD/OVERLOAD HAZARD
 - RISK OF ELECTRIC SHOCK
 - RISK OF FIRE
 - RISK OF ENTANGLEMENT

Safety messages in this catalog use the guidelines of the American National Standard ANSI Z535.4 for Product Safety Signs and Labels and ANSI Z535.3 Criteria for Safety Symbols. Messages associated with specific products use a triangular hazard alert symbol, signal word (CAUTION, WARNING, DANGER) and how to avoid the hazard. Each message refers to pages (754-756) which provides additional safety symbols and three-part messages advising of:

- The hazard
- **How to avoid the hazard**
- *The probable consequence of not avoiding the hazard*

PLEASE READ AND FOLLOW these messages to avoid injury to yourself and bystanders.

* These symbols are excerpted from ISO 7010: 2011 with the permission of ANSI on behalf of ISO. © ISO 2014 - All rights reserved.

Electrical, Electronic Service

(pliers, cutters, mini-torch)

WARNING



- Broken tips or cut material can fly.
Wear safety shield. (User and bystanders)
Flying material can cause injury.



- Material can cause sparks or flying particles when heated.
Wear safety goggles. (User and bystanders)
Sparks and flying particles can cause injury.



- Butane will explode or burn when ignited.
Do not store butane at a temperature above 120°.



- **Hold Butane away from body and face.**



- *Explosion or flames can cause injury.*
- Electrical shock hazard.
Do not use on live electrical circuits.
Electrical shock can cause injury.

Extractors

WARNING



- Drilling pilot holes, inserting extractors and using extractors can cause flying chips. Extractors can break if overloaded.
Wear safety goggles. (User and bystanders)
For hand use only.
Flying chips and broken tools can cause injury.

Gear Head Torque Multipliers

WARNING

- Use of gear head torque multipliers for torque control may result in inaccurate torque application.
For accurate control of torque use an Electrotork®, a Torqometer® or other measuring device located directly on the fastener.
Limited accuracy of the torque ratio of a gear head torque multiplier may cause improper preload of the fastener if it is used for torque control.

Hand Tools

WARNING



- Chrome and industrial finish hand tools can break if overloaded or used for the wrong application.
Wear safety goggles. (User and bystanders)
Do not use chrome or industrial finish hand tools with power drivers.
Use only impact sockets and accessories with impact wrenches.
Use only power sockets and accessories with power wrenches.
Broken hand tools, sockets or accessories can cause injury.



- Electrical shock hazard.
Do not use on live electrical circuits.
Electrical shock can cause injury.

Impact Drivers

WARNING



- Impact drivers can cause tool breakage or flying objects.
Wear safety goggles. (User and bystanders)
Flying objects can cause injury.



- **Wear hearing protection. (User and bystanders)**

Knives

WARNING



- Blades are sharp and can cut. Blades can break causing flying objects.
Wear safety goggles. (User and bystanders)
Do not pry or bend blade.
Keep away from children.
Sharp edges and flying objects can cause injury.

Nut Splitters

WARNING



- Use of impact wrench can cause nut splitter to break.
Wear safety goggles. (User and bystanders)
Do not use with impact wrench.
Broken tools can cause injury.



Plastic Handled Tools

WARNING



- Plastic handles do not protect from electrical shock.
Do not use on live electrical circuits.
Electrical shock can cause injury.

Pliers/Cutters

WARNING



- Broken tips or cut material can fly.
Wear safety goggles. (User and bystanders)
Flying material can cause injury.

Prybars

WARNING



- Prying can cause flying chips. Chipped or cracked prybars can cause flying chips. Prybars can chip if struck.
Wear safety goggles. (User and bystanders)
Do not use pipe or lever extension.
Do not use a prybar if chipped or cracked.
Do not use a prybar as a punch or hammer.
Flying chips can cause injury.



Pullers, Presses

WARNING



- Puller parts under stress can break.
Wear safety goggles. (User and bystanders)
Broken parts can cause injury.

Ratchets

WARNING



- Ratchet mechanism may slip or break if dirty. Mismatched or partially worn parts can cause ratchet to slip or break.
Frequently inspect, clean and lubricate all non-sealed ratchet mechanisms with light oil.
Do not immerse sealed ratchet in fluids.
Do not replace worn parts individually, use entire contents of the service kit.
Ratchets that slip or break can cause injury.

Riveting, Sanding, Door Tools

WARNING



- Riveting and nut setting tools can cause flying chips.
Wear safety goggles. (User and bystanders)
Flying chips can cause injuries.

Scrapers

WARNING



- Scrapers and putty knives can break if used for prying or chiseling.
Wear safety goggles. (User and bystanders)
Do not use a scraper or putty knife as a prybar or chisel.
Broken tools can cause injury.



Screwdrivers

WARNING



- Screwdrivers can break if used as prybar, chisel or punch.
Wear safety goggles. (User and bystanders)
Do not use a screwdriver as a prybar, chisel or punch.
Broken screwdriver can cause injury.



Socket Usage

Select the proper type of socket for the application.

⚠️ WARNING



- **Hand Sockets** - All chrome plated sockets and black finished sockets identified as hand sockets are for hand use only.



- **Impact Sockets** - Sockets designed for durability when used with impact drivers; use only impact sockets with impact drivers.

Wear safety goggles. (Users and bystanders)

Broken tools can cause injury.

Storage Units

⚠️ WARNING



- Storage units can tip or strike you. **Do not open more than one loaded drawer at a time. Keep children away.**



Close lid and lock drawers and doors before moving.



Apply brakes on locking casters when not moving unit.



Do not step in or on drawers.



Secure units together with fasteners.

Read and follow instruction manual.

Tipping of storage unit or unit striking you can cause injury.

- Units edges can cut or pinch.

Do not pull; push to move.

Wear gloves when lifting by edges.

Keep feet and fingers clear of edges when stacking, hanging or moving units.

Unit edges can cause injury.

Striking and Struck Tools, Punches/Chisels

⚠️ WARNING



- Striking and struck tools can break or chip. Chipped or mushroomed punch and chisel ends or metal weakened by improper grinding can fragment.

Oversized hammer can chip the punch or chisel. Wear safety goggles. (Users and bystanders)

Do not use punch or chisel having mushroomed ends; dress edges or mushroomed ends to original shape with a hand file.

Hammer head diameter should be approximately 3/8" larger than head of punch or chisel.

Flying objects can cause injury.

- Steel punches and chisels can cause sparks during use.

Do not use near flammable substance.

Flammable substances can ignite causing injury.



Power Tools

(impact wrenches, ratchets, hammers, sanders, grinders, cut-off tools)

⚠️ WARNING



- Power tools can cause flying particles. **Wear safety goggles (user and bystanders).**

Flying particles can cause injury.



- Power tools generate noise

Wear hearing protection (user and bystanders).

Prolonged exposure to noise can cause hearing loss.



- Power tools vibrate

Avoid prolonged exposure to vibration.

Prolonged exposure to vibration can cause injury.

- Improper use of power tools and accessories can cause broken tools

Do not use without all guards in place.

Use accessories rated at tool RPM or higher.

Read and follow instructions before using power tools.

- Broken tools can cause injury.

Hammers

⚠️ WARNING



- Hammers can cause flying chips. Chipped, mushroomed or cracked hammers can cause flying chips. Glancing blows can cause flying chips. Striking hard surface can cause flying chips. Body hammers can chip or break if struck against hard surfaces.



Wear safety goggles. (Users and bystanders)

Do not use chipped, mushroomed or cracked hammers.

Strike squarely and avoid glancing blows.

Do not strike other hammers or similar hard surfaces.

Use body hammers only for striking automotive type sheet metal; do not strike hard surfaces.

Flying chips can cause injury.



- Steel hammers can cause sparks during use.

Do not use near flammable substance.

Flammable substances can ignite causing injury.

- COMPOTHANE® or urethane hammers can rupture or ignite if exposed to liquid oxygen.

Do not use COMPOTHANE® or urethane hammers near liquid oxygen.

Ruptured and/or ignited COMPOTHANE® or urethane can cause injury.

Threading

⚠️ WARNING



- Threading and rethreading tools can cause flying chips.

Wear safety goggles. (Users and bystanders)

Flying chips can cause injury.

Torque Testers

⚠️ WARNING



- Calibration weights can cause tester and its base to tip.

Wear safety goggles. (Users and bystanders)

Counterbalance or anchor mounting base.

Tipping base can cause injury.

Torque Wrenches

⚠️ WARNING



- Overtorquing can cause breakage. Wrench can break while breaking fasteners loose. Force against flex stops on flex head torque wrenches can cause head breakage. An out of calibration torque wrench can cause part or tool breakage.



Wear safety goggles. (Users and bystanders)

Do not exceed rated torque.

Do not use a torque wrench to break fasteners loose.

Do not force head of flex head torque wrenches against stops.

Periodic recalibration is necessary to maintain accuracy.

Broken tools can cause injury.

Wrenches

⚠️ WARNING



- Excess force can cause crowfoot or flare nut wrench slippage.

Do not over-torque, no pipes or lever extensions.

Use only moderate force on crowfoot and flare nut wrenches.

Broken or slipping wrenches can cause injury.

- Slimline wrenches can break if overloaded.

Wear safety goggles. (Users and bystanders)

Broken wrench jaw can cause injury.

INDEX

A full-page background image showing two workers in blue uniforms and safety harnesses working on a large, yellow industrial machine. The workers are positioned vertically, one above the other, with various cables and mechanical parts visible. The background is a light-colored, textured wall.

PRODUCT CODE INDEX 524
ALPHABETICAL TOOL INDEX 549

Product Code	Page #	Product Code	Page #	Product Code	Page #	Product Code	Page #	Product Code	Page #
1-100-04-1-0.....	465	1-111-04-3-0.....	466	1-170-06-3-0.....	468	1-230-10-3-0.....	469	1215MRCU.....	155
1-100-04-2-0.....	465	1-111-06-1-0.....	466	1-170-08-1-0.....	468	1-230-10-3-2.....	469	1215MRSS.....	155
1-100-04-3-0.....	465	1-111-06-2-0.....	466	1-170-08-1-2.....	468	1-230-12-1-0.....	469	1216MRCU.....	155
1-100-06-1-0.....	465	1-111-06-3-0.....	466	1-170-08-2-0.....	468	1-230-12-2-0.....	469	1216MRSS.....	155
1-100-06-1-2.....	465	1-111-08-1-0.....	466	1-170-08-2-2.....	468	1-230-12-3-0.....	469	1216RCU.....	155
1-100-06-2-0.....	465	1-111-08-2-0.....	466	1-170-08-3-0.....	468	1-473-06-2-2.....	463	1216RSS.....	155
1-100-06-2-2.....	465	1-111-08-3-0.....	466	1-170-10-1-0.....	468	1-476-04-3-2.....	463	1217MRCU.....	155
1-100-06-3-0.....	465	1-143-04-1-0.....	467	1-170-10-1-2.....	468	1-476-04-3-2-TH.....	134	1217MRSS.....	155
1-100-08-1-0.....	465	1-143-04-2-0.....	467	1-170-10-2-0.....	468	1-478-08-1-2.....	463	1218MRCU.....	155
1-100-08-1-2.....	465	1-143-04-3-0.....	467	1-170-10-3-0.....	468	10002MRMH.....	65	1218MRSS.....	155
1-100-08-2-0.....	465	1-143-06-1-0.....	467	1-170-10-3-2.....	468	10002MRPHW.....	64	1218RCU.....	155
1-100-08-3-0.....	465	1-143-06-1-2.....	467	1-210-04-1-0.....	469	10005MFRMH.....	65	1218RSS.....	155
1-100-10-1-0.....	465	1-143-06-2-0.....	467	1-210-04-2-0.....	469	1002EFRMH.....	60	1219MRCU.....	155
1-100-10-1-2.....	465	1-143-06-2-2.....	467	1-210-04-3-0.....	469	1002-F-MT2W.....	58	1219MRSS.....	155
1-100-10-2-0.....	465	1-143-06-3-0.....	467	1-210-06-1-0.....	469	1002MFRMH.....	65	1220RCU.....	155
1-100-10-2-2.....	465	1-143-08-1-0.....	467	1-210-06-1-2.....	469	1002MFRPHW.....	64	1220RSS.....	155
1-100-10-3-0.....	465	1-143-08-1-2.....	467	1-210-06-2-0.....	469	100NMIMHW.....	66	1222RCU.....	155
1-100-12-1-0.....	465	1-143-08-2-0.....	467	1-210-06-2-2.....	469	100P-5MD-TH.....	120	1222RSS.....	155
1-100-12-2-0.....	465	1-143-08-3-0.....	467	1-210-06-3-0.....	469	100T-I-SETW.....	67	1224RCU.....	155
1-100-12-3-0.....	465	1-143-10-1-0.....	467	1-210-06-3-2.....	469	100T-IW.....	67	1224RSS.....	155
1-104-10-2-0.....	465	1-143-10-1-2.....	467	1-210-08-1-0.....	469	101-I-MT2W.....	58	1446.....	498
1-104-10-3-0.....	465	1-143-10-2-0.....	467	1-210-08-1-2.....	469	10-21-51.....	437	15005-F-MT2W.....	58
1-104-12-2-0.....	465	1-143-10-2-2.....	467	1-210-08-2-0.....	469	10-24-23.....	437	1501MRMH.....	65
1-104-12-3-0.....	465	1-143-10-3-0.....	467	1-210-08-2-2.....	469	10-24-51.....	437	1501MRPHW.....	64
1-104-14-3-0.....	465	1-143-12-1-0.....	467	1-210-08-3-0.....	469	10-30-23.....	437	1501TP-1-SETW.....	62
1-106-08-1-0.....	465	1-143-12-2-0.....	467	1-210-10-1-0.....	469	10-30-51.....	437	1501TP-1W.....	62
1-106-08-1-2.....	465	1-143-12-3-0.....	467	1-210-10-1-2.....	469	10ST-I-SETW.....	67	1501TPA-1-SETW.....	62
1-106-10-1-0.....	465	1-145-12-0-0.....	467	1-210-10-2-0.....	469	10ST-IW.....	67	1501TPA-1W.....	62
1-106-10-1-2.....	465	1-145-14-0-0.....	467	1-210-10-2-2.....	469	10T-I-SETW.....	67	1502MRMH.....	65
1-106-12-1-0.....	465	1-160-04-1-0.....	468	1-210-10-3-0.....	469	10T-IW.....	67	1502TP-1SETW.....	62
1-110-04-1-0.....	466	1-160-04-2-0.....	468	1-210-12-1-0.....	469	1146-FLOAT.....	498	1502TP-1W.....	62
1-110-04-2-0.....	466	1-160-04-3-0.....	468	1-210-12-1-2.....	469	1199BBL.....	146	1503MFRMH.....	65
1-110-04-3-0.....	466	1-160-06-1-0.....	468	1-210-12-2-0.....	469	12002EFRMH.....	60	150MFIMHSSW.....	66
1-110-06-1-0.....	466	1-160-06-1-2.....	468	1-210-12-2-2.....	469	1208MRCU.....	155	151NSMW.....	63
1-110-06-2-0.....	466	1-160-06-2-0.....	468	1-210-12-3-0.....	469	1208MRSS.....	155	151SMW.....	63
1-110-06-3-0.....	466	1-160-06-2-2.....	468	1-210-14-1-0.....	469	1209MRCU.....	155	151SP-SETW.....	63
1-110-08-1-0.....	466	1-160-06-3-0.....	468	1-230-04-1-0.....	469	1209MRSS.....	155	151SPW.....	63
1-110-08-1-2.....	466	1-160-08-1-0.....	468	1-230-04-2-0.....	469	1210MRCU.....	155	1520 G.....	485
1-110-08-2-0.....	466	1-160-08-1-2.....	468	1-230-04-3-0.....	469	1210MRSS.....	155	1600-MT2W.....	58
1-110-08-2-2.....	466	1-160-08-2-0.....	468	1-230-06-1-0.....	469	1210RCU.....	155	166-6-16-2.5-12.....	477
1-110-08-3-0.....	466	1-160-08-2-2.....	468	1-230-06-1-2.....	469	1210RSS.....	155	168-6-3.2-1P.....	476
1-110-10-1-0.....	466	1-160-08-3-0.....	468	1-230-06-2-0.....	469	1211MRCU.....	155	168-6-3.5-1P.....	476
1-110-10-1-2.....	466	1-160-10-1-0.....	468	1-230-06-2-2.....	469	1211MRSS.....	155	168-8-4.0-1P.....	476
1-110-10-2-0.....	466	1-160-10-1-2.....	468	1-230-06-3-0.....	469	1212MRCU.....	155	168-8-4.0-3P.....	476
1-110-10-2-2.....	466	1-160-10-2-0.....	468	1-230-08-1-0.....	469	1212MRSS.....	155	168-8-4.0-6.....	476
1-110-10-3-0.....	466	1-160-10-3-0.....	468	1-230-08-1-2.....	469	1212RCU.....	155	168-8-4.5-1P.....	476
1-110-10-3-2.....	466	1-160-12-1-0.....	468	1-230-08-2-0.....	469	1212RSS.....	155	168-8-4.5-6.....	476
1-110-12-1-0.....	466	1-160-12-2-0.....	468	1-230-08-2-2.....	469	1213MRCU.....	155	168-8-4.8-1P.....	476
1-110-12-2-0.....	466	1-170-04-3-0.....	468	1-230-08-3-0.....	469	1213MRSS.....	155	168-8-4.8-3P.....	476
1-110-12-3-0.....	466	1-170-06-1-0.....	468	1-230-10-1-0.....	469	1214MRCU.....	155	168-8-4.8-6.....	476
1-110-14-1-0.....	466	1-170-06-1-2.....	468	1-230-10-1-2.....	469	1214MRSS.....	155	168-8-5.2-1P.....	476
1-111-04-1-0.....	466	1-170-06-2-0.....	468	1-230-10-2-0.....	469	1214RCU.....	155	168-8-5.2-6.....	476
1-111-04-2-0.....	466	1-170-06-2-2.....	468	1-230-10-2-2.....	469	1214RSS.....	155	168-8-5.5-1P.....	476

Product Code	Page #	Product Code	Page #	Product Code	Page #	Product Code	Page #	Product Code	Page #
168-8-5.5-3P.....	476	200T-I-SETW.....	67	2521S-160.....	513	3526-TH.....	103	3830-38-VIP.....	446
168-8-5.5-6.....	476	200T-IW.....	67	2535L.....	502	3528-TH.....	103	3830-40-VIP.....	446
168-8-6.3-1P.....	476	201-O-MT2W.....	58	2600-16-XT11-HP.....	430	3530-TH.....	103	3830-41-VIP.....	446
2-300-14-0-0.....	470	20651-TH.....	128	2600-22-XT-HP.....	430	3532-TH.....	103	3830-43-VIP.....	446
2-300-14-2-0.....	470	208.....	439	2628S-160.....	513	3534-TH.....	103	3830-44-VIP.....	446
2-300-14-4-0.....	470	2101S-140.....	510	2628S-180.....	513	3536-TH.....	103	3830-46-VIP.....	446
2-300-16-0-0.....	470	2101S-160.....	510	2628S-200.....	513	3538-TH.....	103	3830-48-VIP.....	446
2-300-16-1-0.....	470	2101S-180.....	510	268.....	439	3540-TH.....	103	3830-51-VIP.....	446
2-300-16-2-0.....	470	215-150.....	440	2700-22-XT7-HP.....	430	3542-TH.....	103	3830-52-VIP.....	446
2-300-16-4-0.....	470	216-150-R.....	435	2700-24-XT7-HP.....	430	3544-TH.....	103	3830-54-VIP.....	446
2-300-18-0-0.....	470	216-300-R.....	440	2700-24-XT7-HP-TH.....	132	3546-TH.....	103	3830-56-VIP.....	446
2-300-18-2-0.....	470	218.....	439	2744.....	485	3548-TH.....	103	3830-57-VIP.....	446
2-301-14-0-0.....	470	21SP-SETW.....	63	276-61.....	58	36.....	504	3830-59-VIP.....	446
2-301-14-2-0.....	470	21SPW.....	63	2806-35V.....	516	3654BMS/7.....	462	3830-60-VIP.....	446
2-301-16-0-0.....	470	2223S-150.....	511	2806-52V.....	516	369-BLADE.....	429	3830-64-VIP.....	446
2-301-16-1-0.....	470	225-PLUS.....	438	2820VBC.....	516	3734BMS/7.....	462	3830-65-VIP.....	446
2-301-16-2-0.....	470	225-PLUS-3906-TH.....	133	2820VHELP.....	515	3736MH-250.....	462	3830-67-VIP.....	446
2-302-14-0-0.....	470	228.....	439	2820VP.....	515	3736MH-300.....	462	3830-68-VIP.....	446
2-302-14-2-0.....	470	228-15-5P.....	440	2820VPC.....	515	3736MH-400.....	462	3830-70-VIP.....	446
2-302-14-4-0.....	470	228-32-5P.....	440	2820VTEE.....	515	3739H-250.....	462	3830-73-VIP.....	446
2-302-16-0-0.....	470	23-21.....	436	28449-TH.....	132	3739H-300.....	462	3830-76-VIP.....	446
2-302-16-1-0.....	470	23-24.....	436	296.....	435	3739H-400.....	462	3830-79-VIP.....	446
2-302-16-2-0.....	470	23-30.....	436	300-14-F15/16-HP.....	428	3750H.....	462	3830-83-VIP.....	446
2-302-16-4-0.....	470	23-36.....	436	300T-I-SETW.....	67	3816-300.....	440	3830-86-VIP.....	446
2-302-18-0-0.....	470	2401EFRMH.....	60	300T-IW.....	67	3818-300-PROG-100.....	440	3830-89-VIP.....	446
2-302-18-2-0.....	470	2421S-140.....	511	301.....	435	3818-300-PROG-5P.....	440	3830-92-VIP.....	446
2-303-14-2-0.....	471	2421S-160.....	511	303-5P.....	435	3830-102-VIP.....	446	3830-95-VIP.....	446
2-303-16-0-0.....	471	2421S-180.....	511	306.....	439	3830-105-VIP.....	446	3830-98-VIP.....	446
2-303-16-1-0.....	471	2427S-160.....	512	3090-20-XT11-HP.....	430	3830-108-VIP.....	446	3832-102.....	449
2-303-16-2-0.....	471	2427S-200.....	512	31 R US.....	175	3830-111-VIP.....	446	3832-105.....	449
2-303-16-4-0.....	471	2430S-140.....	512	3100TB.....	492	3830-114-VIP.....	446	3832-108.....	449
2-303-18-0-0.....	471	2430S-160.....	512	3100TBTS4.....	426	3830-121-VIP.....	446	3832-111.....	449
2-303-18-2-0.....	471	2430S-200.....	512	3150-12-XT9-HP.....	433	3830-127-VIP.....	446	3832-114.....	449
2-304-14-0-0.....	471	2444.....	498	317.....	438	3830-133-VIP.....	446	3832-121.....	449
2-304-14-2-0.....	471	2444-LAP.....	428	3180-14-XT11-HP.....	431	3830-140-VIP.....	446	3832-127.....	449
2-304-14-4-0.....	471	2446.....	498	319.....	438	3830-146-VIP.....	446	3832-133.....	449
2-304-16-0-0.....	471	2446-SAFE.....	498	319-TH.....	133	3830-14-VIP.....	446	3832-14.....	449
2-304-16-1-0.....	471	2448.....	498	32242.....	115	3830-152-VIP.....	446	3832-140.....	449
2-304-16-2-0.....	471	2489.....	486	32244.....	115	3830-16-VIP.....	446	3832-146.....	449
2-304-16-4-0.....	471	2500-16-XT-HP.....	430	32246.....	115	3830-17-VIP.....	446	3832-152.....	449
2-304-18-0-0.....	471	2500-19-XT-HP.....	430	3240-14-XT11-HP.....	432	3830-19-VIP.....	446	3832-16.....	449
2-304-18-2-0.....	471	2500-22-XT-HP.....	430	32442.....	115	3830-20-VIP.....	446	3832-17.....	449
2-470-14-2-0.....	464	25003MRMH.....	65	32444.....	115	3830-21-VIP.....	446	3832-19.....	449
2-470-14-4-0.....	464	2502MRMH.....	65	32446.....	115	3830-22-VIP.....	446	3832-20.....	449
2-470-16-1-0.....	464	2502MRPHW.....	64	325.....	438	3830-24-VIP.....	446	3832-21.....	449
2-471-16-1-0.....	464	2503EFRMH.....	60	32834-TH.....	117	3830-25-VIP.....	446	3832-22.....	449
2-472-14-2-0.....	464	2503-F-MT2W.....	58	33 HR US.....	175	3830-27-VIP.....	446	3832-24.....	449
2-472-16-0-0.....	464	2503MFRMH-TH.....	108	331-21-51-KP.....	437	3830-29-VIP.....	446	3832-25.....	449
2-472-16-1-0.....	464	2503MFRMH.....	65	332-21-51.....	437	3830-30-VIP.....	446	3832-27.....	449
2-472-16-2-0.....	464	2503MFRPHW.....	64	333.....	437	3830-32-VIP.....	446	3832-29.....	449
2001-I-MT2W.....	58	250MFIMHSSW.....	66	333-5.....	437	3830-33-VIP.....	446	3832-30.....	449
2002MRMH.....	65	2520 S.....	516	350NMIMHW.....	66	3830-35-VIP.....	446	3832-32.....	449
200NMIMHW.....	66	2521S-140.....	513	3524-TH.....	103	3830-37-VIP.....	446	3832-33.....	449

Product Code	Page #	Product Code	Page #	Product Code	Page #	Product Code	Page #	Product Code	Page #
3832-35	449	3833-44-C	445	3834-EXT-2	451	3940-100-14-SC-2P	454	3940-150-6-ST-10P	455
3832-37	449	3833-48-C	445	3834-UPSIZE	451	3940-100-14-SC-5P	454	3940-150-6-ST-2P	455
3832-38	449	3833-51-C	445	3845-18-10P	459	3940-100-14-ST-10P	455	3940-150-6-ST-5P	455
3832-40	449	3833-54-C	445	3845-24-100P-BULK	459	3940-100-14-ST-2P	455	3940-150-8/12-ST-100P	455
3832-41	449	3833-57-C	445	3845-24-10P	459	3940-100-14-ST-5P	455	3940-150-8/12-ST-10P	455
3832-43	449	3833-60-C	445	3845-32-100P-BULK	459	3940-100-18-SC-2P	454	3940-150-8/12-ST-2P	455
3832-44	449	3833-64-C	445	3845-32-10P	459	3940-100-18-SC-5P	454	3940-150-8/12-ST-5P	455
3832-46	449	3833-65-C	445	3846-100-DG-ST-2P	461	3940-100-18-ST-10P	455	3940-228-10/14-PR09-100P	457
3832-48	449	3833-67-C	445	3846-100-G-ST-2P	461	3940-100-18-ST-2P	455	3940-228-10/14-PR09-10P	457
3832-51	449	3833-68-C	445	3846-150-10-HST-1P	460	3940-100-18-ST-5P	455	3940-228-10/14-PR13-100P	457
3832-52	449	3833-70-C	445	3846-150-6-DSL-1P	460	3940-100-24-SC-2P	454	3940-228-10-DSL-10P	457
3832-54	449	3833-73-C	445	3846-150-6-SL-1P	461	3940-100-24-SC-5P	454	3940-228-10-DSL-2P	457
3832-56	449	3833-76-C	445	3846-150-8-HST-1P	460	3940-100-24-ST-10P	455	3940-228-10-DSL-5P	457
3832-57	449	3833-77-C	445	3846-150-DG-ST-2P	461	3940-100-24-ST-2P	455	3940-228-10-HST-10P	454
3832-59	449	3833-79-C	445	3846-228-10-HST-1P	460	3940-100-24-ST-5P	455	3940-228-10-HST-2P	454
3832-60	449	3833-83-C	445	3846-228-3-ST-1P	461	3940-150-10-HST-10P	454	3940-228-10-HST-5P	454
3832-64	449	3833-86-C	445	3846-228-6-DSL-1P	460	3940-150-10-HST-2P	454	3940-228-10-ST-100P	455
3832-65	449	3833-89-C	445	3846-228-6-ST-1P	461	3940-150-10-HST-5P	454	3940-228-10-ST-10P	455
3832-67	449	3833-92-C	445	3846-228-8-HST-1P	460	3940-150-10-ST-100P	455	3940-228-10-ST-2P	455
3832-68	449	3833-95-C	445	3846-300-10-HST-1P	460	3940-150-10-ST-10P	455	3940-228-10-ST-5P	455
3832-70	449	3833-98-C	445	3846-300-2-CB-1P	461	3940-150-10-ST-2P	455	3940-228-14-HST-10P	454
3832-73	449	3833-SET-101	444	3846-300-3-ST-1P	461	3940-150-10-ST-5P	455	3940-228-14-HST-2P	454
3832-76	449	3833-SET-201	444	3846-300-6-DSL-1P	460	3940-150-14-HST-10P	454	3940-228-14-HST-5P	454
3832-79	449	3834-ADP	451	3846-300-6-ST-1P	461	3940-150-14-HST-2P	454	3940-228-14-ST-100P	455
3832-83	449	3834-ARBR-11152	451	3846-300-8-HST-1P	460	3940-150-14-HST-5P	454	3940-228-14-ST-10P	455
3832-86	449	3834-ARBR-11152QC	451	3846-457-2-CB-1P	461	3940-150-14-ST-100P	455	3940-228-14-ST-2P	455
3832-89	449	3834-ARBR-1130	451	3870-SG11	486	3940-150-14-ST-10P	455	3940-228-14-ST-5P	455
3832-92	449	3834-ARBR-16152QC	451	3875-BP1	492	3940-150-14-ST-2P	455	3940-228-18-HST-10P	454
3832-95	449	3834-ARBR-630	451	3906-250-18-100	440	3940-150-14-ST-5P	455	3940-228-18-HST-2P	454
3832-98	449	3834-ARBR-730	451	3906-250-18-5P	440	3940-150-18-HST-10P	454	3940-228-18-HST-5P	454
3833-102C	445	3834-ARBR-9100	451	3906-250-24-100	440	3940-150-18-HST-2P	454	3940-228-18-ST-100P	455
3833-105C	445	3834-ARBR-9100EL	451	3906-250-24-5P	440	3940-150-18-HST-5P	454	3940-228-18-ST-10P	455
3833-108C	445	3834-ARBR-9100ES	451	3906-250-32-100	440	3940-150-18-ST-100P	455	3940-228-18-ST-2P	455
3833-109C	445	3834-ARBR-9100ESM	451	3906-250-32-5P	440	3940-150-18-ST-10P	455	3940-228-18-ST-5P	455
3833-111C	445	3834-ARBR-9100QC	451	3906-300-14-100	440	3940-150-18-ST-2P	455	3940-228-5/8-DSL-10P	457
3833-114C	445	3834-ARBR-930	451	3906-300-14-10P	440	3940-150-18-ST-5P	455	3940-228-5/8-DSL-2P	457
3833-121C	445	3834-ARBR-930EL	451	3906-300-14-5P	440	3940-150-24-ST-100P	455	3940-228-5/8-DSL-5P	457
3833-127C	445	3834-ARBR-930ES	451	3906-300-18-100	440	3940-150-24-ST-10P	455	3940-228-6-SL-10P	456
3833-140C	445	3834-ARBR-930ESM	451	3906-300-18-10P	440	3940-150-24-ST-2P	455	3940-228-6-SL-2P	456
3833-152C	445	3834-ARBR-SD152QC	451	3906-300-18-2P	440	3940-150-24-ST-5P	455	3940-228-6-SL-5P	456
3833-159C	445	3834-ARBR-SD30	451	3906-300-18-5P	440	3940-150-4/6-SC-10P	454	3940-228-8/12-PR13-100P	457
3833-19-C	445	3834-DRL	451	3906-300-24-100	440	3940-150-4/6-SC-2P	454	3940-228-8/12-ST-100P	455
3833-20-C	445	3834-DRL-CT	451	3906-300-24-10P	440	3940-150-4/6-SC-5P	454	3940-228-8/12-ST-10P	455
3833-22-C	445	3834-DRL-EL	451	3906-300-24-2P	440	3940-150-5/8-DSL-10P	457	3940-228-8/12-ST-2P	455
3833-25-C	445	3834-DRL-EL	451	3906-300-24-5P	440	3940-150-5/8-DSL-2P	457	3940-228-8/12-ST-5P	455
3833-27-C	445	3834-DRL-ES	451	3906-300-32-100	440	3940-150-5/8-DSL-5P	457	3940-300-10-HST-10P	454
3833-29-C	445	3834-DRL-ES	451	3906-300-32-10P	440	3940-150-5/8-SL-100P	456	3940-300-10-HST-2P	454
3833-30-C	445	3834-DRL-HSS-ES	451	3906-300-32-2P	440	3940-150-5/8-SL-10P	456	3940-300-10-HST-5P	454
3833-32-C	445	3834-DRL-L	451	3906-300-32-5P	440	3940-150-5/8-SL-2P	456	3940-300-14-HST-10P	454
3833-35-C	445	3834-ES	451	3906-300-3P	440	3940-150-5/8-SL-5P	456	3940-300-14-HST-2P	454
3833-38-C	445	3834-EXT-1	451						
3833-40-C	445								
3833-41-C	445								

Product Code	Page #	Product Code	Page #	Product Code	Page #	Product Code	Page #	Product Code	Page #
3940-300-14-HST-5P	454	3946-300-6-ST-1P	461	420SH-120-600	485	4750-HDLB-1	488	6MV-17	517
3940-300-14-ST-100P	455	396-LAP	428	420SH-120-800	485	4750-HHO-2	488	6MV-18	517
3940-300-14-ST-10P	455	4-138-08-1-0	471	420SH-140-400	485	4750-KP-1	488	6MV-19	517
3940-300-14-ST-2P	455	4-138-10-1-0	471	420SH-175-400	485	4750PTB50	489	6MV-8	517
3940-300-14-ST-5P	455	4-140-06-1-0	471	420SH-50-100	485	4750PTB60	489	6MV-9	517
3940-300-18-HST-10P	454	4-140-08-1-0	471	420SH-50-200	485	4750PTB65TS4	427	7224S	514
3940-300-18-HST-2P	454	4-140-10-1-0	471	420SH-60-120	485	4750PTW47	489	7502MRMHWS	65
3940-300-18-HST-5P	454	4-150-07-3-0	471	420SH-60-300	485	4750-UP-1	488	752MFRMHWS	65
3940-300-18-ST-100P	455	4-152-08-2-2	472	420SH-80-160	485	4750-UP-1TS5	427	75MFIMHSSW	66
3940-300-18-ST-10P	455	4-153-08-1-2	472	424P-10	483	501-I-MT2W	58	7800DMV-10	518
3940-300-18-ST-2P	455	4-154-08-2-2	464	424P-12	483	501MRMHWS	65	7800DMV-11	518
3940-300-18-ST-5P	455	4-155-08-2-0	472	424P-18	483	50NMMMHWS	66	7800DMV-12	518
3940-300-5/8-DSL-10P	457	4-155-10-2-0	472	424P-25	483	50T-I-SETW	67	7800DMV-13	518
3940-300-5/8-DSL-2P	457	4-183-04-2-2	472	424P-32	483	50T-IW	67	7800DMV-14	518
3940-300-5/8-DSL-5P	457	4-183-05-2-2	472	424P-6	483	51-12	436	7800DMV-15	518
3940-300-6-SL-10P	456	4-183-06-2-0	472	424P-6S-PP	483	51-21	436	7800DMV-16	518
3940-300-6-SL-2P	456	4-183-06-2-2	472	424-S6-LR	483	51-24	436	7800DMV-17	518
3940-300-6-SL-5P	456	4-183-07-2-0	472	426TOR9	487	51-30	436	7800DMV-18	518
3940-300-8/12-SL-100P	456	4-183-08-2-0	472	434-10	483	51-36	436	7800DMV-19	518
3940-300-8/12-SL-10P	456	4-183-10-2-0	472	434-12	483	5T-I-SETW	67	7800DMV-8	518
3940-300-8/12-SL-2P	456	4-186-04-2-0	473	434-18	483	5T-IW	67	782-U	481
3940-300-8/12-SL-5P	456	4-186-04-2-2	473	434-25	483	6-342-08-1-0	474	800NMMMHWS	66
3942-150-7-SL-10P	459	4-186-05-2-0	473	434-32	483	6-342-08-1-2	474	806-1-1	517
3942-150-7-SL-2P	459	4-186-05-2-2	473	434-38	483	6-342-08-2-2	474	8069 R US	177
3942-150-7-SL-5P	459	4-186-06-2-0	473	434-6	483	6-342-10-1-0	474	8069 RC US	177
3942-228-11-HSL-10P	458	4-186-06-2-2	473	434-S3-EUR	483	6-343-08-3-0	474	8070 R US	177
3942-228-11-HSL-2P	458	4-186-07-2-0	473	434-S6-EUR	483	6-343-10-3-0	474	8070 RC US	177
3942-228-11-HSL-5P	458	4-186-08-2-0	473	442	482	6-344-08-2-2	475	8070RCUS-TH	104
3942-228-5-HSL-10P	458	4-187-04-2-0	473	449	482	6-345-08-2-2	475	8070V	517
3942-228-5-HSL-2P	458	4-187-06-2-0	473	451	482	6004ERMH	60	8071 R US	177
3942-228-5-HSL-5P	458	4-187-06-2-2	473	4553	486	6004-F-MT2W	58	8071 RC US	177
3942-228-7-HSL-10P	458	4-187-07-2-0	473	4559-12	485	6004MFRMH-TH	108	8071RCUS-TH	104
3942-228-7-HSL-2P	458	4-187-08-2-0	473	4559-18	485	6004MFRMHWS	65	8071V	517
3942-228-7-HSL-5P	458	4-188-06-2-0	473	4559-24	485	6004MFRPHWS	64	8072 R US	177
3942-228-7-SL-10P	459	4-272-06-3-0	474	4559-30	485	600T-I-SETW	67	8072 RC US	177
3942-228-7-SL-2P	459	4-288-06-2-0	473	4559-36	485	600T-IW	67	8072RCUS-TH	104
3942-228-7-SL-5P	459	4004MFRMHWS	65	4559-42	485	61NSMW	63	8072V	517
3942-300-5-HSL-10P	458	401NSMW	63	474-125-0.60	483	61SMW	63	8073 R US	177
3942-300-5-HSL-2P	458	401SMW	63	474-125-0.80	483	61SP-SETW	63	8073 RC US	177
3942-300-5-HSL-5P	458	401SP-SETW	63	474-150-0.80	483	61SPW	63	8073RCUS-TH	104
3942-300-7-HSL-10P	458	401SPW	63	4750-2PP-1	488	625	482	8073V	517
3942-300-7-HSL-2P	458	416-400	487	4750-3PB-1	488	625-DROP	482	8074 R US	177
3942-300-7-HSL-5P	458	416-600	487	4750-EP-1	488	625-PEAR	482	8074 RC US	177
3942-300-7-SL-10P	459	420SC-25	484	4750FB1-19A	490	625-ROUND	482	8074RCUS-TH	104
3942-300-7-SL-2P	459	420SC-50	484	4750FB1-19B	490	650	482	8074V	517
3942-300-7-SL-5P	459	420SH-100-200	485	4750FB2-19A	491	665	482	8075 R US	177
3944-300-3-MEAT-1P	459	420SH-120-1000	485	4750FB2-24A	491	6MV-10	517	8075 RC US	177
3946-100-G-ST-2P	461	420SH-120-1250	485	4750FB2W-24A	490	6MV-11	517	8075RCUS-TH	104
3946-150-6-SL-1P	461	420SH-120-1500	485	4750FB3-12	491	6MV-12	517	807SXUSA	336
3946-150-G-ST-2P	461	420SH-120-250	485	4750FB3-12TS4	426	6MV-13	517	808060	508
3946-228-3-ST-1P	461	420SH-120-300	485	4750FB4-18	489	6MV-14	517	808061	508
3946-300-3-ST-1P	461	420SH-120-400	485	4750FB5B	491	6MV-15	517	808062	508
		420SH-120-500	485	4750FB5C	491	6MV-16	517	8150-1/2V	518

Product Code	Page #	Product Code	Page #	Product Code	Page #	Product Code	Page #	Product Code	Page #
8160-1/2V.....	518	9071 RPC US	176	DR1X3.5-10PK.....	137	HSB-1.5A-TH	127	JHW1033C.....	162
8162-1/2V.....	518	9072 R US	177	DR1X3.5-50PK.....	137	HSSG-A0616M.....	481	JHW1037.....	162
850-1	482	9072 RC US.....	177	DR5X225100PK.....	137	HSSG-A1020M.....	481	JHW1037B.....	162
86.....	177	9072 RP US.....	176	DR5X22510PK.....	137	HSSG-A1225EC	481	JHW1038.....	162
862007.....	447	9072 RPC US	176	DR5X225NC100.....	137	HSSG-A1225M.....	481	JHW1038A.....	162
862013.....	447	9073 R US	177	DR5X225NC10P.....	137	HSSG-C0616M.....	481	JHW1039B.....	162
862017.....	447	9073 RC US.....	177	DR-CORD-10PK.....	137	HSSG-C1020M.....	481	JHW10507.....	188
862021.....	447	9073 RP US.....	176	DR-MICRO10PK	137	HSSG-C1225EC.....	481	JHW10509.....	188
862109.....	447	9073 RPC US	176	EXTC2CCO10PK.....	92	HSSG-C1225M.....	481	JHW10600.....	167
862209.....	447	91CUS	175	EXTC2LCO10PK.....	92	HSSG-D0606M.....	481	JHW10602.....	167
863307.....	448	92CUS	175	EXTH2HCO10PK.....	92	HSSG-D0807M.....	481	JHW10604.....	167
863313.....	448	93CUS	175	EXT-H2HCOIL.....	92	HSSG-D1009M.....	481	JHW10606.....	167
865-1	482	94CUS	175	EXTH2L1X72HD.....	91	HSSG-D1211EC.....	481	JHW10650.....	167
87.....	177	95CUS	175	EXTH2L1X72MD.....	91	HSSG-D1211M.....	481	JHW10650-TH.....	103
9-12-51/3806-KP.....	436	96CUS.....	175	EXTH2LBU10PK.....	91	HSSG-E0614M.....	481	JHW10652.....	167
9-36-23-KP	437	97CUS.....	175	EXTH2QRC10PK.....	92	HSSG-E1222EC.....	481	JHW10652-TH.....	103
9-467-00-0-0.....	476	AG-BAG-36.....	489	EXT-H2QRCOIL.....	92	HSSG-E1222M.....	481	JHW10654.....	167
9-484-3.2-10.....	477	AW2-1/2D.....	58	EXTH2R1X72HD.....	91	HSSG-F0618M.....	481	JHW10654-TH.....	103
9-484-3.2-1P.....	477	BE-8010S.....	509	EXTT2T.5X12.....	91	HSSG-F1225M.....	481	JHW10656.....	167
9-484-5.2-10.....	477	BE-8040S-TH.....	120	EXTT2T.5X24.....	91	HSSG-G0618M.....	481	JHW10656-TH.....	103
9-484-5.2-1P.....	477	BE-8050S.....	509	EXTT2T.5X36.....	91	HSSG-G1220M.....	481	JHW10658.....	167
9-485-04-1P.....	478	BE-8050S-TH.....	120	EXTT2T51210P.....	91	HSSG-G1225EC.....	481	JHW10658-TH.....	103
9-485-05-1P.....	478	BE-8065S.....	509	EXTT2T51810P.....	91	HSSG-G1225M.....	481	JHW11030.....	153
9-485-06-10.....	478	BE-8220S.....	509	EXTT2T52410P.....	91	HSSG-M0618M.....	481	JHW11032.....	153
9-485-06-1P.....	478	BE-8220S-TH.....	120	EXTT2T53610P.....	91	HSSG-M1227M.....	481	JHW1104MM.....	165
9-485-09-10.....	478	BE-8230S.....	509	EXTT2TCO110P.....	92	IM1-TH.....	136	JHW1105.5MM.....	165
9-485-09-1P.....	478	BE-8255S.....	509	EXT-T2TCOIL.....	92	IM243P.....	320	JHW1105MM.....	165
9-485-13-10.....	478	BE-8600S.....	509	FM10	475	ISSXTMD610.....	291	JHW1106MM.....	165
9-485-13-1P.....	478	BE-8610S.....	509	HOL-1TOOLBLT.....	94	JH6CF05T03TB.....	398	JHW1107MM.....	165
9-486-04-10.....	478	BE-8610S-TH.....	120	HOL1TOOLBLTR.....	94	JH6CF10T05TB.....	398	JHW1108MM.....	165
9-486-04-1P.....	478	BE-8620S.....	509	HOL-1TOOLHAR.....	94	JH6CF20T05TB.....	398	JHW1109MM.....	165
9-486-05-10.....	478	BE-8620S-TH.....	120	HOL1TOOLHARR.....	94	JH6CF30T05TB.....	398	JHW1110MM.....	165
9-486-05-1P.....	478	BE-8630S.....	509	HOL-1TOOLXD.....	94	JHISSX620S75.....	290	JHW1111MM.....	165
9-486-07-1P.....	478	BE-8640S.....	509	HOL-2TOOLBLT.....	94	JHMWS1123NRC.....	159	JHW1112A.....	164
9-486-08-10.....	478	BE-9881S.....	509	HOL2TOOLBLTR.....	94	JHMWS1124NRC.....	159	JHW1112MM.....	165
9-486-C-10.....	478	BELTCOMF-2XL.....	96	HOL-2TOOLHAR.....	94	JHMWS1125NRC.....	159	JHW1113A.....	164
9-486-C-1P.....	478	BELTCOMF-3XL.....	96	HOL2TOOLHARR.....	94	JHMWS1126NRC.....	159	JHW1113MM.....	165
9-488-02-10.....	477	BELTCOMFL-XL.....	96	HOLADJRADIOC.....	94	JHSFH1819AW.....	182	JHW1114A.....	164
9029 R US	176	BELTCOMF-M.....	96	HOL-BOTTLE.....	94	JHW097411A.....	53	JHW1114MM.....	165
9029 RT US	176	BELTCOMF-S.....	96	HOLBOTTLECOM.....	94	JHW099965A.....	53	JHW1115A.....	164
9031 R US	176	BELTDRL010PK.....	96	HOLBOXWHARR.....	94	JHW100P-19MD.....	330	JHW1115MM.....	165
9031 RC US.....	176	BELTRRLO10PK.....	96	HOL-HAMMER.....	94	JHW100P-5MD.....	331	JHW1116A.....	164
9031 RP US.....	176	BELT-TRLOOP.....	96	HOLHAMMERCOM.....	94	JHW100P-6PD.....	331	JHW1116MM.....	165
9031 RT US	176	BKT-100DRAWC.....	97	HOL-POUCHRET.....	94	JHW100P-6SD.....	331	JHW1118A.....	164
9033 R US	176	BKT-100HLC.....	97	HOLSCAFFWCOM.....	94	JHW100P-8MD.....	330	JHW1120A.....	164
9035 R US	176	BKT-120SCAF.....	97	HOLSCAFFWRET.....	94	JHW100TAP.....	415	JHW1122A.....	164
9070 R US	177	BKT-48SCAF.....	97	HOL-TAPERET.....	94	JHW10107.....	188	JHW1124A.....	164
9070 RC US.....	177	BKT-72SCAF.....	97	HOLTAPESLEEV.....	94	JHW10111.....	188	JHW1128A.....	164
9070 RP US.....	176	BKT-HBINSERT.....	97	HRFM10	476	JHW10113.....	188	JHW11310.....	153
9070 RPC US	176	BS-63A	114	HS1.5X2-25PK.....	138	JHW1020.....	162	JHW11312.....	153
9071 R US	177	C-807-TH.....	129	HS1X175-25PK.....	138	JHW10213.....	188	JHW11314.....	153
9071 RC US.....	177	C-812-TH.....	129	HS-2X4-10PK.....	138	JHW1027B.....	162	JHW11316.....	153
9071 RP US.....	176	C-818-TH.....	129	HS-3X4-10PK.....	138	JHW1033A.....	162	JHW11318.....	153

Product Code	Page #	Product Code	Page #	Product Code	Page #	Product Code	Page #	Product Code	Page #
JHW11320.....	153	JHW11957.....	145	JHW1209M	152	JHW1212RS	154	JHW1216RC.....	156
JHW11322.....	153	JHW11958.....	145	JHW1209MNRC.....	159	JHW1212RSC	150	JHW1216RCF.....	161
JHW11324.....	153	JHW11959.....	145	JHW1209MRC	157	JHW1212SC.....	142	JHW1216RCS	160
JHW1132A	164	JHW1195B	146	JHW1209MRCF	161	JHW1212SC-TH.....	98	JHW1216RC-TH.....	100
JHW1136A	164	JHW11960.....	145	JHW1209MRCS	160	JHW1212YSC	151	JHW1216RS	154
JHW1140A	164	JHW11961.....	145	JHW1209MRCTH.....	100	JHW1213M	152	JHW1216RSC	150
JHW1143812TH	134	JHW11962.....	145	JHW1209MSC	148	JHW1213MNRC.....	159	JHW1216SC.....	142
JHW11690.....	167	JHW11963.....	145	JHW1209MSCTH.....	99	JHW1213MRC	157	JHW1216SC-TH.....	98
JHW11691.....	167	JHW11964.....	145	JHW1210TOB	181	JHW1213MRCF	161	JHW1216YSC	151
JHW11692.....	167	JHW11965.....	145	JHW1210BSC	146	JHW1213MRCS.....	160	JHW1217M	152
JHW11692-TH.....	103	JHW11966.....	145	JHW1210M	152	JHW1213MRCTH.....	100	JHW1217MNRC.....	159
JHW1178A	142	JHW11967.....	145	JHW1210MNRC.....	159	JHW1213MRS.....	154	JHW1217MRC	157
JHW1178AB.....	146	JHW11968.....	145	JHW1210MRC	157	JHW1213MSC	148	JHW1217MRCF	161
JHW1180.....	142	JHW11969.....	145	JHW1210MRCF	161	JHW1213MSCTH.....	99	JHW1217MRCS	160
JHW1180B	146	JHW1197.....	142	JHW1210MRCS	160	JHW1214BSC	146	JHW1217MRCTH.....	100
JHW1180-TH	98	JHW11970.....	145	JHW1210MRCTH.....	100	JHW1214M	152	JHW1217MRS.....	154
JHW1182.....	142	JHW1197B	146	JHW1210MRS.....	154	JHW1214MNRC.....	159	JHW1217MSC	148
JHW1182B	146	JHW1198.....	142	JHW1210MSC	148	JHW1214MRC	157	JHW1217MSCTH.....	99
JHW1182-TH	98	JHW1198A	142	JHW1210MSCTH.....	99	JHW1214MRCF	161	JHW1218BSC	146
JHW1184.....	142	JHW1198ABL.....	146	JHW1210NRC.....	158	JHW1214MRCS.....	160	JHW1218MNRC.....	159
JHW1184B	146	JHW1198B	142	JHW1210RC.....	156	JHW1214MRCTH.....	100	JHW1218MRC	157
JHW1184-TH.....	98	JHW1198BBL.....	146	JHW1210RCF.....	161	JHW1214MRS.....	154	JHW1218MRCF	161
JHW1186.....	142	JHW1198BL	146	JHW1210RCS	160	JHW1214MSC	148	JHW1218MRCS	160
JHW1186B	146	JHW1198C	142	JHW1210RC-TH.....	100	JHW1214MSCTH.....	99	JHW1218MRCTH.....	100
JHW1188.....	142	JHW1198CBL	146	JHW1210RS	154	JHW1214NRC.....	158	JHW1218MRS.....	154
JHW1188B	146	JHW1199.....	142	JHW1210SC.....	142	JHW1214RC.....	156	JHW1218MSC	148
JHW1190.....	142	JHW11990.....	145	JHW1210SC-TH.....	98	JHW1214RCF.....	161	JHW1218MSCTH.....	99
JHW11900.....	153	JHW1199A	142	JHW1211M	152	JHW1214RCS	160	JHW1218NRC.....	158
JHW11901.....	153	JHW1199ABL.....	146	JHW1211MNRC.....	159	JHW1214RC-TH.....	100	JHW1218RC.....	156
JHW11902.....	153	JHW1199B	142	JHW1211MRC	157	JHW1214RS	154	JHW1218RCF.....	161
JHW11903.....	153	JHW1199BL	146	JHW1211MRCF	161	JHW1214RSC	150	JHW1218RCS	160
JHW11904.....	153	JHW1199C	142	JHW1211MRCS	160	JHW1214SC.....	142	JHW1218RC-TH.....	100
JHW11905.....	153	JHW1199CBL	146	JHW1211MRCTH.....	100	JHW1214SC-TH.....	98	JHW1218RS	154
JHW11906.....	153	JHW1206MNRC.....	159	JHW1211MRS.....	154	JHW1214YSC	151	JHW1218RSC	150
JHW1190B	146	JHW1206MRC	157	JHW1211MSC	148	JHW1215M	152	JHW1218SC.....	142
JHW1191.....	142	JHW1206MSC	148	JHW1211MSCTH.....	99	JHW1215MNRC.....	159	JHW1218SC-TH.....	98
JHW1191B	146	JHW1207MNRC.....	159	JHW1211RS	154	JHW1215MRC	157	JHW1218YSC	151
JHW1192.....	142	JHW1207MSC	148	JHW1211SC.....	142	JHW1215MRCF	161	JHW1219M	152
JHW11920.....	235	JHW1207MSCTH.....	99	JHW1212BSC	146	JHW1215MRCS.....	160	JHW1219MNRC.....	159
JHW1192B	146	JHW1208M	152	JHW1212M	152	JHW1215MRCTH.....	100	JHW1219MRC	157
JHW1193.....	142	JHW1208MNRC.....	159	JHW1212MNRC.....	159	JHW1215MRS.....	154	JHW1219MRCF	161
JHW1193B	146	JHW1208MRC	157	JHW1212MRC	157	JHW1215MSC	148	JHW1219MRCS.....	160
JHW1194.....	142	JHW1208MRCF	161	JHW1212MRCF	161	JHW1215MSCTH.....	99	JHW1219MRCTH.....	100
JHW11940.....	153	JHW1208MRCS	160	JHW1212MRCS.....	160	JHW1216BSC	146	JHW1219MRS.....	154
JHW1194B	146	JHW1208MRCTH.....	100	JHW1212MRCTH.....	100	JHW1216MNRC.....	159	JHW1219MSC	148
JHW1195.....	142	JHW1208MSC	148	JHW1212MRS.....	154	JHW1216MRC	157	JHW1219MSCTH.....	99
JHW11950.....	145	JHW1208MSCTH.....	99	JHW1212MSC	148	JHW1216MRCF	161	JHW1220BSC	146
JHW11951.....	145	JHW1208NRC.....	158	JHW1212MSCTH.....	99	JHW1216MRCS.....	160	JHW1220MNRC.....	159
JHW11952.....	145	JHW1208RC.....	156	JHW1212NRC.....	158	JHW1216MRCTH.....	100	JHW1220MSC	148
JHW11953.....	145	JHW1208RC-TH.....	100	JHW1212RC.....	156	JHW1216MRS.....	154	JHW1220MSCTH.....	99
JHW11954.....	145	JHW1208RS	154	JHW1212RCF.....	161	JHW1216MSC	148	JHW1220NRC.....	158
JHW11955.....	145	JHW1208SC.....	142	JHW1212RCS.....	160	JHW1216MSCTH.....	99	JHW1220RC.....	156
JHW11956.....	145	JHW1208SC-TH.....	98	JHW1212RC-TH.....	100	JHW1216NRC.....	158	JHW1220RCF.....	161

Product Code	Page #	Product Code	Page #	Product Code	Page #	Product Code	Page #	Product Code	Page #
JHW1220RCS	160	JHW1226NRC	158	JHW1234NRC	158	JHW1252TOB	181	JHW13504	367
JHW1220RC-TH	100	JHW1226RC	156	JHW1234RSC	150	JHW1252TSB	181	JHW13506	367
JHW1220RS	154	JHW1226RC-TH	100	JHW1234SC	142	JHW1254TOB	181	JHW13508	367
JHW1220RSC	150	JHW1226RSC	150	JHW1234SC-TH	98	JHW1256TOB	181	JHW13510	367
JHW1220SC	142	JHW1226SC	142	JHW1234TOB	181	JHW1258TOB	181	JHW13512	367
JHW1220SC-TH	98	JHW1226SC-TH	98	JHW1234TOE	180	JHW12601	153	JHW13514	367
JHW1220YSC	151	JHW1226TSB	181	JHW1234TSB	181	JHW12603	153	JHW13516	367
JHW1221MNRC	159	JHW1226YSC	151	JHW1234YSC	151	JHW12605	153	JHW13518	367
JHW1221MRC	157	JHW1227MNRC	159	JHW1236BSC	146	JHW12607	153	JHW13520	367
JHW1221MSC	148	JHW1227MSC	148	JHW1236MSC	148	JHW1260TOB	181	JHW13522	367
JHW1221MSCTH	99	JHW1227MSCTH	99	JHW1236MSCTH	99	JHW12-610	255	JHW13524	367
JHW1222BSC	146	JHW1228BSC	146	JHW1236NRC	158	JHW12-612	255	JHW13526	367
JHW1222MNRC	159	JHW1228MNRC	159	JHW1236RSC	150	JHW12-614	255	JHW13528	367
JHW1222MRC	157	JHW1228NRC	158	JHW1236SC	142	JHW12-616	255	JHW13530	367
JHW1222MSC	148	JHW1228RC	156	JHW1236SC-TH	98	JHW12-618	255	JHW13532	367
JHW1222MSCTH	99	JHW1228RC-TH	100	JHW1236TOB	181	JHW12-620	255	JHW13542	367
JHW1222NRC	158	JHW1228RSC	150	JHW1236TOE	180	JHW12-622	255	JHW13544	367
JHW1222RC	156	JHW1228SC	142	JHW1236TSB	181	JHW12-624	255	JHW13550	367
JHW1222RCF	161	JHW1228SC-TH	98	JHW1236YSC	151	JHW12-626	255	JHW13551	367
JHW1222RCS	160	JHW1228TOE	180	JHW1238NRC	158	JHW12-628	255	JHW13552	367
JHW1222RC-TH	100	JHW1228TSB	181	JHW1238SC	142	JHW12-630	255	JHW13553	367
JHW1222RS	154	JHW1228YSC	151	JHW1240BSC	146	JHW12-632	255	JHW13554	367
JHW1222RSC	150	JHW1229MSC	148	JHW1240RSC	150	JHW1264TOB	181	JHW13555	367
JHW1222SC	142	JHW1230822TH	134	JHW1240SC	142	JHW1266TOB	181	JHW13556	367
JHW1222SC-TH	98	JHW1230BSC	146	JHW1240SC-TH	98	JHW12691	153	JHW13557	367
JHW1222YSC	151	JHW1230MNRC	159	JHW1240TOB	181	JHW1270TOB	181	JHW13558	367
JHW1223MNRC	159	JHW1230MSC	148	JHW1240TOE	180	JHW1272TOB	181	JHW13560	367
JHW1223MSC	148	JHW1230MSCTH	99	JHW1240TSB	181	JHW1276TOB	181	JHW13562	367
JHW1223MSCTH	99	JHW1230NRC	158	JHW1240YSC	151	JHW1282TOB	181	JHW13563	367
JHW1224BSC	146	JHW1230RC	156	JHW1242	142	JHW1284TOB	181	JHW13564	367
JHW1224MNRC	159	JHW1230RC-TH	100	JHW1242B	146	JHW1288TOB	181	JHW13565	367
JHW1224MRC	157	JHW1230RSC	150	JHW1242-TH	98	JHW1294TOB	181	JHW13566	367
JHW1224MSC	148	JHW1230SC	142	JHW1242TOB	181	JHW12M-607	258	JHW13567	367
JHW1224MSCTH	99	JHW1230SC-TH	98	JHW1242TOE	180	JHW12M-608	258	JHW13568	367
JHW1224NRC	158	JHW1230TOE	180	JHW1242TSB	181	JHW12M-609	258	JHW13569	367
JHW1224RC	156	JHW1230TSB	181	JHW1244	142	JHW12M-610	258	JHW13570	367
JHW1224RCF	161	JHW1230YSC	151	JHW1244B	146	JHW12M-611	258	JHW13571	367
JHW1224RCS	160	JHW1232BSC	146	JHW1244-TH	98	JHW12M-612	258	JHW13572	367
JHW1224RC-TH	100	JHW1232MNRC	159	JHW1244TOB	181	JHW12M-613	258	JHW13573	367
JHW1224RS	154	JHW1232MSC	148	JHW1244TOE	180	JHW12M-614	258	JHW13574	367
JHW1224RSC	150	JHW1232MSCTH	99	JHW1246	142	JHW12M-615	258	JHW13575	367
JHW1224SC	142	JHW1232NRC	158	JHW1246B	146	JHW12M-616	258	JHW13576	367
JHW1224SC-TH	98	JHW1232RC	156	JHW1246-TH	98	JHW12M-617	258	JHW13577	367
JHW1224TSB	181	JHW1232RC-TH	100	JHW1246TOB	181	JHW12M-618	258	JHW13578	367
JHW1224YSC	151	JHW1232RSC	150	JHW1246TOE	180	JHW12M-619	258	JHW13609	188
JHW1225MNRC	159	JHW1232SC	142	JHW1246TSB	181	JHW12M-620	258	JHW13625A	178
JHW1225MRC	157	JHW1232SC-TH	98	JHW1248	142	JHW12M-621	258	JHW13625-TH	104
JHW1225MSC	148	JHW1232TOE	180	JHW1248B	146	JHW12M-622	258	JHW13TH	180
JHW1225MSCTH	99	JHW1232TSB	181	JHW1248-TH	98	JHW12M-623	258	JHW140	348
JHW1226BSC	146	JHW1232YSC	151	JHW1248TOB	181	JHW12M-624	258	JHW141	348
JHW1226MNRC	159	JHW1234BSC	146	JHW1248TOE	180	JHW13213	188	JHW14-1216	300
JHW1226MSC	148	JHW1234MSC	148	JHW1248TSB	181	JHW13500	367	JHW14-1218	300
JHW1226MSCTH	99	JHW1234MSCTH	99	JHW1250TOB	181	JHW13502	367	JHW14-1220	300

Product Code	Page #	Product Code	Page #	Product Code	Page #	Product Code	Page #	Product Code	Page #
JHW14-1222	300	JHW14M-610	299	JHW1731A	162	JHW17-678	323	JHW207A	179
JHW14-1224	300	JHW14M-611	299	JHW1731B	162	JHW17-680	323	JHW208A	179
JHW14-1226	300	JHW14M-612	299	JHW1753-TC	59	JHW17-682	323	JHW209	179
JHW14-1228	300	JHW14M-613	299	JHW17-6100	323	JHW17-684	323	JHW209A	179
JHW14-1230	300	JHW14M-614	299	JHW17-6104	323	JHW17-686	323	JHW2101PG-7	352
JHW14-1232	300	JHW14M-615	299	JHW17-6108	323	JHW17-688	323	JHW2-103A	253
JHW14-1234	300	JHW14M-616	299	JHW17-6112	323	JHW17-690	323	JHW2-106A	253
JHW14-1236	300	JHW14M-617	299	JHW17-6116	323	JHW17-692	323	JHW211	179
JHW14-1238	300	JHW14M-618	299	JHW17-6118	323	JHW17-694	323	JHW211A	179
JHW14-1240	300	JHW14M-619	299	JHW17-6120	323	JHW17-696	323	JHW2-140B	253
JHW142	348	JHW14M-620	299	JHW17-6122	323	JHW1904A	178	JHW21661	386
JHW143	348	JHW14M-621	299	JHW17-6124	323	JHW1905	178	JHW21HDG-5.5	351
JHW144	348	JHW14M-622	299	JHW17-6126	323	JHW1905-TH	104	JHW21HDG-6	351
JHW14-612	296	JHW14M-623	299	JHW17-6128	323	JHW1906	178	JHW21HDG-7	351
JHW14-614	296	JHW14M-624	299	JHW17-6130	323	JHW1906B	178	JHW21HDG-8	351
JHW14-616	296	JHW14M-625	299	JHW17-6132	323	JHW1906-TH	104	JHW23070	359
JHW14-618	296	JHW14M-626	299	JHW17-6134	323	JHW1907	178	JHW23071	359
JHW14-620	296	JHW14M-627	299	JHW17-6136	323	JHW1907A	178	JHW23072	360
JHW14-622	296	JHW14M-629	299	JHW17-6138	323	JHW1907-TH	104	JHW23074	360
JHW14-624	296	JHW14M-630	299	JHW17-6140	323	JHW1908	178	JHW23076	360
JHW14-626	296	JHW14M-632	299	JHW17-6142	323	JHW1908A	178	JHW23080	356
JHW14-628	296	JHW14M-634	299	JHW17-6144	323	JHW1908-TH	104	JHW23201	359
JHW14-630	296	JHW14M-635	299	JHW17-6146	323	JHW1909	178	JHW23202	359
JHW14-632	296	JHW14M-636	299	JHW17-6148	323	JHW1909A	178	JHW23203	359
JHW14-634	296	JHW16-624	312	JHW17-6152	323	JHW1909-TH	104	JHW23210	359
JHW14-636	296	JHW16-626	312	JHW17-6156	323	JHW1910	178	JHW23211	359
JHW14-638	296	JHW16-628	312	JHW17-6160	323	JHW1910-TH	104	JHW23220	359
JHW14-640	296	JHW16-630	312	JHW17-6172	323	JHW1911	178	JHW23221	359
JHW14-642	296	JHW16-632	312	JHW17-6184	323	JHW1911A	178	JHW23222	360
JHW14-644	296	JHW16-634	312	JHW17-632	323	JHW1911-TH	104	JHW23223	360
JHW14-646	296	JHW16-636	312	JHW17-634	323	JHW1912	178	JHW23224	360
JHW14-648	296	JHW16-638	312	JHW17-636	323	JHW1912-TH	104	JHW23225	360
JHW14M-1210	300	JHW16-640	312	JHW17-638	323	JHW2-02B	253	JHW23301	360
JHW14M-1211	300	JHW16-642	312	JHW17-640	323	JHW20401	375	JHW23302	360
JHW14M-1212	300	JHW16-644	312	JHW17-642	323	JHW20402	375	JHW23302A-TH	125
JHW14M-1213	300	JHW16-646	312	JHW17-644	323	JHW204A	179	JHW23303	360
JHW14M-1214	300	JHW16-648	312	JHW17-646	323	JHW205	179	JHW23303A-TH	125
JHW14M-1215	300	JHW16-648BW	309	JHW17-648	323	JHW20542	374	JHW23304	360
JHW14M-1216	300	JHW16-650	312	JHW17-648BW	320	JHW20542-TH	127	JHW23305	360
JHW14M-1217	300	JHW16-652	312	JHW17-650	323	JHW20543	374	JHW23309	360
JHW14M-1218	300	JHW16-654	312	JHW17-652	323	JHW20543-TH	127	JHW23310	360
JHW14M-1219	300	JHW16-656	312	JHW17-654	323	JHW20544	374	JHW23310A-TH	125
JHW14M-1220	300	JHW16-658	312	JHW17-656	323	JHW20544-TH	127	JHW23320	360
JHW14M-1221	300	JHW16-660	312	JHW17-658	323	JHW20545	374	JHW23321	360
JHW14M-1222	300	JHW16-664	312	JHW17-660	323	JHW20545-TH	127	JHW23321A-TH	125
JHW14M-1223	300	JHW1721	162	JHW17-662	323	JHW20546	374	JHW2-33B	253
JHW14M-1224	300	JHW1723	162	JHW17-664	323	JHW20546-TH	127	JHW23503	355
JHW14M-1225	300	JHW1725	162	JHW17-666	323	JHW206	179	JHW23503-TH	124
JHW14M-1227	300	JHW1725B	162	JHW17-668	323	JHW20651	375	JHW23506	356
JHW14M-1229	300	JHW1727	162	JHW17-670	323	JHW20678	375	JHW23506-TH	124
JHW14M-1230	300	JHW1729	162	JHW17-672	323	JHW20678-TH	128	JHW23518	356
JHW14M-1232	300	JHW1729B	162	JHW17-674	323	JHW206B	179	JHW23521	356
JHW14M-1233	300	JHW1731	162	JHW17-676	323	JHW207	179	JHW23524	355

Product Code	Page #	Product Code	Page #	Product Code	Page #	Product Code	Page #	Product Code	Page #
JHW23533	356	JHW28253	357	JHW30410-TH	110	JHW31150-TH	113	JHW31536	239
JHW23535	356	JHW28255	357	JHW30411-TH	110	JHW31152	239	JHW31537	239
JHW23541	356	JHW28301	358	JHW30412-TH	110	JHW31152-TH	113	JHW31538	239
JHW23542	356	JHW28305	358	JHW30414-TH	110	JHW31154	239	JHW31539	239
JHW23543	356	JHW28307	358	JHW30416-TH	110	JHW31154-TH	113	JHW31612BT	241
JHW23801A	362	JHW28309	358	JHW30418-TH	110	JHW31208-TH	112	JHW31614BT	241
JHW23802A	362	JHW28351	358	JHW30604A	209	JHW31210-TH	112	JHW31616BT	241
JHW23803A	362	JHW28449	378	JHW30605A	209	JHW31212-TH	112	JHW31618BT	241
JHW23804A	362	JHW2979D-7	349	JHW30606A	209	JHW31214-TH	112	JHW31620BT	241
JHW24101	336	JHW2A-616	258	JHW30607A	209	JHW31216-TH	112	JHW31622BT	241
JHW24102	336	JHW2A-616-2	258	JHW30608A	209	JHW31218-TH	112	JHW31624BT	241
JHW24103	336	JHW2A-618	258	JHW30609A	209	JHW31220-TH	112	JHW31708BT	241
JHW24104	336	JHW2A-618-2	258	JHW30610A	209	JHW31222-TH	112	JHW31709BT	241
JHW24105	336	JHW2M-607	256	JHW30611A	209	JHW31224-TH	112	JHW31710BT	241
JHW2420G-5	352	JHW2M-608	256	JHW30612A	209	JHW31226-TH	112	JHW31711BT	241
JHW2427G-6	353	JHW2M-609	256	JHW30613A	209	JHW31228-TH	112	JHW31712BT	241
JHW2427G-8	353	JHW2M-610	256	JHW30614A	209	JHW31230-TH	112	JHW31713BT	241
JHW2430G-5.5	352	JHW2M-611	256	JHW30699A	209	JHW31232-TH	112	JHW31714BT	241
JHW2430G-6	352	JHW2M-612	256	JHW30804	210	JHW31301	243	JHW31715BT	241
JHW24900	342	JHW2M-613	256	JHW30805	210	JHW31303	243	JHW31716BT	241
JHW2-4A	253	JHW2M-614	256	JHW30806	210	JHW31308	243	JHW31717BT	241
JHW24TH	180	JHW2M-615	256	JHW30807	210	JHW31310	243	JHW31718BT	241
JHW2520	358	JHW2M-616	256	JHW30808	210	JHW31312	243	JHW31719BT	241
JHW2521G-6	353	JHW2M-617	256	JHW30809	210	JHW31314	243	JHW31806	247
JHW2535L-TH	135	JHW2M-618	256	JHW30810	210	JHW31316	243	JHW31807	247
JHW2-608	254	JHW2M-619	256	JHW30811	210	JHW31318	243	JHW31808	247
JHW2-610	254	JHW2MA-612	258	JHW30812	210	JHW31320	243	JHW31809	247
JHW2-612	254	JHW2MA-612-2	258	JHW30813	210	JHW31322	243	JHW31810	247
JHW2-614	254	JHW2MA-614	258	JHW30814	210	JHW31324	243	JHW31811	247
JHW2-616	254	JHW2MA-614-2	258	JHW30855	210	JHW31326	243	JHW31812	247
JHW2-618	254	JHW30006A	205	JHW30902-TH	110	JHW31328	243	JHW31813	247
JHW2-620	254	JHW30008	205	JHW30904-TH	110	JHW31330	243	JHW31814	247
JHW2620-80	358	JHW30013	206	JHW30906	212	JHW31332	243	JHW31815	247
JHW2-622	254	JHW30023	206	JHW30908	212	JHW31408-TH	112	JHW31816	247
JHW2-624	254	JHW30024	206	JHW30925	209	JHW31410-TH	112	JHW31817	247
JHW2-626	254	JHW30025	206	JHW30941	210	JHW31412-TH	112	JHW31818	247
JHW2-628	254	JHW30026	206	JHW31013	235	JHW31414-TH	112	JHW31819	247
JHW2628G-6	349	JHW30027	206	JHW31016A	235	JHW31416-TH	112	JHW31910	251
JHW2628G-7	349	JHW30028	206	JHW31023	235	JHW31418-TH	112	JHW31912	251
JHW2628G-8	349	JHW30206-TH	109	JHW31024	235	JHW31420-TH	112	JHW31934	247
JHW2-630	254	JHW30207-TH	109	JHW31025	235	JHW31422-TH	112	JHW31936	247
JHW2-632	254	JHW30208-TH	109	JHW31026	235	JHW31424-TH	112	JHW31938	239
JHW28201	357	JHW30209-TH	109	JHW31027	235	JHW31426-TH	112	JHW31939	239
JHW28201-TH	135	JHW30210-TH	109	JHW31028	235	JHW31428-TH	112	JHW31940	243
JHW28203	357	JHW30211-TH	109	JHW31142	239	JHW31430-TH	112	JHW31941	243
JHW28203-TH	135	JHW30212-TH	109	JHW31142-TH	113	JHW31432-TH	112	JHW31947	251
JHW28205	357	JHW30214-TH	109	JHW31144	239	JHW31528	239	JHW32001RK	275
JHW28205-TH	135	JHW30216-TH	109	JHW31144-TH	113	JHW31530	239	JHW32011RK	275
JHW28211	357	JHW30218-TH	109	JHW31146	239	JHW31531	239	JHW32023	275
JHW28221	357	JHW30406-TH	110	JHW31146-TH	113	JHW31532	239	JHW32024	275
JHW28231	357	JHW30407-TH	110	JHW31148	239	JHW31533	239	JHW32025	275
JHW28233	357	JHW30408-TH	110	JHW31148-TH	113	JHW31534	239	JHW32026	275
JHW28251	357	JHW30409-TH	110	JHW31150	239	JHW31535	239	JHW32027	275

Product Code	Page #	Product Code	Page #	Product Code	Page #	Product Code	Page #	Product Code	Page #
JHW32028.....	275	JHW32529.....	283	JHW32836-TH.....	117	JHW35051.....	212	JHW35184.....	251
JHW32212-TH.....	115	JHW32530.....	283	JHW32904.....	287	JHW35052.....	212	JHW35185.....	251
JHW32214-TH.....	115	JHW32532.....	283	JHW32908.....	288	JHW35053.....	212	JHW35186.....	251
JHW32216-TH.....	115	JHW32534.....	283	JHW32941.....	283	JHW35070.....	211	JHW35187.....	251
JHW32218-TH.....	115	JHW32536.....	283	JHW32943.....	283	JHW35070-TH.....	110	JHW35188.....	251
JHW32220-TH.....	115	JHW32709.....	285	JHW32945.....	285	JHW35071.....	211	JHW35192.....	251
JHW32222-TH.....	115	JHW32710.....	285	JHW32947.....	285	JHW35071-TH.....	110	JHW35193.....	251
JHW32224-TH.....	115	JHW32711.....	285	JHW32949-TH.....	117	JHW35072.....	211	JHW35194.....	251
JHW32226-TH.....	115	JHW32712.....	285	JHW32953.....	288	JHW35072-TH.....	110	JHW35195.....	251
JHW32228-TH.....	115	JHW32713.....	285	JHW32960.....	266	JHW35073.....	211	JHW35196.....	251
JHW32230-TH.....	115	JHW32714.....	285	JHW33008.....	305	JHW35073-TH.....	110	JHW35197.....	251
JHW32232-TH.....	115	JHW32715.....	285	JHW33228-TH.....	119	JHW35074.....	211	JHW35198.....	251
JHW32234-TH.....	115	JHW32716.....	285	JHW33230-TH.....	119	JHW35074-TH.....	110	JHW3519M.....	168
JHW32236-TH.....	115	JHW32717.....	285	JHW33232-TH.....	119	JHW35075.....	211	JHW35202-TH.....	117
JHW32238-TH.....	115	JHW32718.....	285	JHW33234-TH.....	119	JHW35075-TH.....	110	JHW35203-TH.....	117
JHW32240-TH.....	115	JHW32719.....	285	JHW33236-TH.....	119	JHW35079.....	212	JHW35204-TH.....	117
JHW32248-TH.....	115	JHW32720.....	285	JHW33238-TH.....	119	JHW35080.....	212	JHW35206-TH.....	117
JHW32412-TH.....	116	JHW32721.....	285	JHW33240-TH.....	119	JHW35081.....	212	JHW35208-TH.....	117
JHW32414-TH.....	116	JHW32722.....	285	JHW33242-TH.....	119	JHW35082.....	212	JHW35210-TH.....	117
JHW32416-TH.....	116	JHW32723.....	285	JHW33244-TH.....	119	JHW35083.....	212	JHW35212-TH.....	117
JHW32418-TH.....	116	JHW32724.....	285	JHW33246-TH.....	119	JHW35084.....	212	JHW35214-TH.....	117
JHW32420-TH.....	116	JHW32725.....	285	JHW33248-TH.....	119	JHW35085.....	212	JHW3521M.....	168
JHW32422-TH.....	116	JHW32726.....	285	JHW33252-TH.....	119	JHW35100-TH.....	113	JHW3522M.....	168
JHW32424-TH.....	116	JHW32727.....	285	JHW33256-TH.....	119	JHW35101-TH.....	113	JHW3524.....	168
JHW32426-TH.....	116	JHW32728.....	285	JHW33258-TH.....	119	JHW35102-TH.....	113	JHW3524M.....	168
JHW32428-TH.....	116	JHW32729.....	285	JHW33260-TH.....	119	JHW35103-TH.....	113	JHW3526.....	168
JHW32430-TH.....	116	JHW32730.....	285	JHW33264-TH.....	119	JHW35104-TH.....	113	JHW35274.....	287
JHW32432-TH.....	116	JHW32732.....	285	JHW33719.....	307	JHW35105-TH.....	113	JHW35274-TH.....	117
JHW32434-TH.....	116	JHW32734.....	285	JHW33722.....	307	JHW35106-TH.....	113	JHW35275.....	287
JHW32436-TH.....	116	JHW32736.....	285	JHW33723.....	307	JHW35107-TH.....	113	JHW35275-TH.....	117
JHW32438-TH.....	116	JHW32809-TH.....	117	JHW33724.....	307	JHW35130.....	251	JHW35276.....	287
JHW32440-TH.....	116	JHW32810-TH.....	117	JHW33727.....	307	JHW35131.....	251	JHW35276-TH.....	117
JHW32448-TH.....	116	JHW32811-TH.....	117	JHW33730.....	307	JHW35132.....	251	JHW35277.....	287
JHW32509.....	283	JHW32812-TH.....	117	JHW33732.....	307	JHW35133.....	251	JHW35277-TH.....	117
JHW32510.....	283	JHW32813-TH.....	117	JHW33735.....	307	JHW35134.....	251	JHW35278.....	287
JHW32511.....	283	JHW32814-TH.....	117	JHW33736.....	307	JHW35135.....	251	JHW35278-TH.....	117
JHW32512.....	283	JHW32815-TH.....	117	JHW33738.....	307	JHW35136.....	251	JHW35279.....	287
JHW32513.....	283	JHW32816-TH.....	117	JHW33741.....	307	JHW35137.....	251	JHW35279-TH.....	117
JHW32514.....	283	JHW32817-TH.....	117	JHW33746.....	307	JHW35164.....	250	JHW3527M.....	168
JHW32515.....	283	JHW32818-TH.....	117	JHW33750.....	307	JHW35165.....	250	JHW3528.....	168
JHW32516.....	283	JHW32819-TH.....	117	JHW33755.....	307	JHW35166.....	250	JHW35283.....	288
JHW32517.....	283	JHW32820-TH.....	117	JHW33760.....	307	JHW35167.....	250	JHW35284.....	288
JHW32518.....	283	JHW32821-TH.....	117	JHW33932.....	307	JHW35168.....	250	JHW35285.....	288
JHW32519.....	283	JHW32822-TH.....	117	JHW35000-TH.....	110	JHW35169.....	250	JHW35286.....	288
JHW32520.....	283	JHW32823-TH.....	117	JHW35001-TH.....	110	JHW35170.....	249	JHW35287.....	288
JHW32521.....	283	JHW32824-TH.....	117	JHW35002-TH.....	110	JHW35171.....	249	JHW35294.....	288
JHW32522.....	283	JHW32825-TH.....	117	JHW35003-TH.....	110	JHW35172.....	249	JHW35295.....	288
JHW32523.....	283	JHW32826-TH.....	117	JHW35004-TH.....	110	JHW35173.....	249	JHW35296.....	288
JHW32524.....	283	JHW32827-TH.....	117	JHW35005-TH.....	110	JHW35174.....	249	JHW35297.....	288
JHW32525.....	283	JHW32828-TH.....	117	JHW35040.....	212	JHW35175.....	249	JHW35298.....	288
JHW32526.....	283	JHW32829-TH.....	117	JHW35041.....	212	JHW35176.....	249	JHW35299.....	288
JHW32527.....	283	JHW32830-TH.....	117	JHW35042.....	212	JHW35182.....	251	JHW3530.....	168
JHW32528.....	283	JHW32832-TH.....	117	JHW35050.....	212	JHW35183.....	251	JHW3530M.....	168

Product Code	Page #	Product Code	Page #	Product Code	Page #	Product Code	Page #	Product Code	Page #
JHW35310.....	255	JHW35524.....	295	JHW36430.....	256	JHW3728-TH.....	101	JHW37817.....	296
JHW35312.....	255	JHW35526.....	295	JHW36432.....	256	JHW3730.....	166	JHW37818.....	296
JHW35314.....	255	JHW35528.....	295	JHW36607.....	257	JHW3732.....	166	JHW37819.....	296
JHW35316.....	255	JHW3552M.....	168	JHW36608.....	257	JHW3732-TH.....	101	JHW3782.....	166
JHW35318.....	255	JHW35530.....	295	JHW36609.....	257	JHW3734.....	166	JHW37820.....	296
JHW3532.....	168	JHW35532.....	295	JHW36610.....	257	JHW3734-TH.....	101	JHW37821.....	296
JHW35320.....	255	JHW35534.....	295	JHW36611.....	257	JHW3736.....	166	JHW37822.....	296
JHW35322.....	255	JHW35536.....	295	JHW36612.....	257	JHW3736-TH.....	101	JHW37823.....	296
JHW35324.....	255	JHW35538.....	295	JHW36613.....	257	JHW3740.....	166	JHW37916.....	296
JHW35326.....	255	JHW3554.....	168	JHW36614.....	257	JHW3740-TH.....	101	JHW37918.....	295
JHW35328.....	255	JHW35540.....	295	JHW36615.....	257	JHW3744.....	166	JHW37923.....	295
JHW3532M.....	168	JHW35542.....	295	JHW36616.....	257	JHW3744-TH.....	101	JHW37924.....	296
JHW35330.....	255	JHW35544.....	295	JHW36617.....	257	JHW3746.....	166	JHW37925.....	298
JHW35332.....	255	JHW35546.....	295	JHW36618.....	257	JHW3746-TH.....	101	JHW38216.....	314
JHW3534.....	168	JHW35548.....	295	JHW36619.....	257	JHW3748.....	166	JHW38218.....	314
JHW3536.....	168	JHW3555M.....	168	JHW36810.....	257	JHW3748-TH.....	101	JHW38220.....	314
JHW3536M.....	168	JHW3556.....	168	JHW36811.....	257	JHW3752.....	166	JHW38224.....	314
JHW3537M.....	168	JHW3558.....	168	JHW36812.....	257	JHW3754.....	166	JHW38226.....	314
JHW3538.....	168	JHW3560.....	168	JHW36813.....	257	JHW3756.....	166	JHW38228.....	314
JHW3538M.....	168	JHW3560M.....	168	JHW36814.....	257	JHW3758.....	166	JHW38232.....	314
JHW3540.....	168	JHW3562.....	168	JHW36815.....	257	JHW3760.....	166	JHW38236.....	315
JHW35407.....	259	JHW3564.....	168	JHW36816.....	257	JHW37610.....	298	JHW38240.....	314
JHW35408.....	259	JHW3565M.....	168	JHW36817.....	257	JHW37611.....	298	JHW38420.....	311
JHW35409.....	259	JHW3568.....	168	JHW36818.....	257	JHW37612.....	298	JHW38422.....	311
JHW3540M.....	168	JHW3572.....	168	JHW36819.....	257	JHW37613.....	298	JHW38424.....	311
JHW35410.....	259	JHW3576.....	168	JHW36906.....	257	JHW37614.....	298	JHW38426.....	311
JHW35411.....	259	JHW35810.....	315	JHW36910.....	257	JHW37615.....	298	JHW38428.....	311
JHW35412.....	259	JHW35812.....	315	JHW36912.....	254	JHW37616.....	298	JHW38430.....	311
JHW35413.....	259	JHW35814.....	315	JHW36922.....	256	JHW37617.....	298	JHW38432.....	311
JHW35414.....	259	JHW35817.....	315	JHW36923.....	257	JHW37618.....	298	JHW38434.....	311
JHW35415.....	259	JHW35819.....	315	JHW36TH.....	180	JHW37619.....	298	JHW38436.....	311
JHW35416.....	259	JHW35821.....	315	JHW3712.....	166	JHW37620.....	298	JHW38438.....	311
JHW35417.....	259	JHW35824.....	315	JHW3714.....	166	JHW37621.....	298	JHW38440.....	311
JHW35418.....	259	JHW35827.....	315	JHW3716.....	166	JHW37622.....	298	JHW38442.....	311
JHW35419.....	259	JHW35830.....	315	JHW3716-TH.....	101	JHW37623.....	298	JHW38444.....	311
JHW3541M.....	168	JHW35832.....	315	JHW3718.....	166	JHW37624.....	298	JHW38446.....	311
JHW3542.....	168	JHW36212.....	254	JHW3718-TH.....	101	JHW37625.....	298	JHW38448.....	311
JHW3542M.....	168	JHW36214.....	254	JHW3720.....	166	JHW37626.....	298	JHW38450.....	311
JHW3544.....	168	JHW36216.....	254	JHW3720-TH.....	101	JHW37627.....	298	JHW38452.....	311
JHW3544M.....	168	JHW36218.....	254	JHW37216.....	295	JHW37628.....	298	JHW38454.....	311
JHW3546.....	168	JHW36220.....	254	JHW37218.....	295	JHW37629.....	298	JHW38456.....	311
JHW3546M.....	168	JHW36222.....	254	JHW3722.....	166	JHW37630.....	298	JHW38458.....	311
JHW3548.....	168	JHW36224.....	254	JHW37220.....	295	JHW37632.....	298	JHW38460.....	311
JHW3548M.....	168	JHW36410.....	256	JHW37222.....	295	JHW37633.....	298	JHW38462.....	311
JHW3550.....	168	JHW36412.....	256	JHW37224.....	295	JHW37634.....	298	JHW38464.....	311
JHW3550M.....	168	JHW36414.....	256	JHW37226.....	295	JHW37635.....	298	JHW38466.....	311
JHW35512.....	295	JHW36416.....	256	JHW37228.....	295	JHW37636.....	298	JHW38468.....	311
JHW35514.....	295	JHW36418.....	256	JHW3722-TH.....	101	JHW3764.....	166	JHW38476.....	311
JHW35516.....	295	JHW36420.....	256	JHW3724.....	166	JHW3780.....	166	JHW38903.....	314
JHW35518.....	295	JHW36422.....	256	JHW3724-TH.....	101	JHW37813.....	296	JHW38925.....	311
JHW3552.....	168	JHW36424.....	256	JHW3726.....	166	JHW37814.....	296	JHW38926.....	311
JHW35520.....	295	JHW36426.....	256	JHW3726-TH.....	101	JHW37815.....	296	JHW38932.....	314
JHW35522.....	295	JHW36428.....	256	JHW3728.....	166	JHW37816.....	296	JHW3M05T150.....	416

Product Code	Page #	Product Code	Page #	Product Code	Page #	Product Code	Page #	Product Code	Page #
JHW3M05T75	416	JHW41180	325	JHW4-644	294	JHW50001A	53	JHW5E05H1GR	412
JHW3M10T160	416	JHW41182	325	JHW4-646	294	JHW50003A	53	JHW5E10H2G	409
JHW3M20T160	416	JHW41184	325	JHW4-648	294	JHW50005A	53	JHW5E10H2GR	412
JHW3S12TV	417	JHW41186	325	JHW471	185	JHW50007A	53	JHW5E15H3G	409
JHW3S20TV	417	JHW41188	325	JHW471-TH	105	JHW50601B	201	JHW5E15H3GR	412
JHW3T12TV	417	JHW41190	325	JHW472	185	JHW50602B	201	JHW5EA05H1G	411
JHW3T20TV	417	JHW41192	325	JHW472-TH	105	JHW50603B	230	JHW5ES05H1G	410
JHW40000	482	JHW41194	325	JHW474	185	JHW50604B	202	JHW5ES05H1GR	410
JHW40000-TH	133	JHW41196	325	JHW474A	185	JHW50605B	227	JHW5ES05H2G	410
JHW40052	500	JHW41200	325	JHW474A-TH	105	JHW50607B	226	JHW5ES05H2GR	410
JHW40082	501	JHW41204	325	JHW474B	185	JHW50609	270	JHW5ES10H2G	410
JHW40084	501	JHW41208	325	JHW474-TH	105	JHW50611B	199	JHW5ES10H2GR	410
JHW40150	493	JHW41212	325	JHW482	185	JHW50612B	198	JHW5ES15H3G	410
JHW40151	502	JHW41220	325	JHW482-TH	105	JHW50613B	229	JHW5ES15H3GR	410
JHW40152	502	JHW41224	325	JHW483	185	JHW50614B	197	JHW5ES15H5G	410
JHW40153	502	JHW41226	325	JHW483-TH	105	JHW50615B	228	JHW5ES15H5GR	410
JHW40154	502	JHW41228	325	JHW484	185	JHW50617B	269	JHW5G102H5G	413
JHW40155	502	JHW4-140B	293	JHW484-TH	105	JHW50619	270	JHW5HD2S100	405
JHW40155-30P	502	JHW42301	493	JHW4A-620	289	JHW50622B	200	JHW5HD2S500	405
JHW40159	502	JHW42302	493	JHW4A-620-2	289	JHW50661B	203	JHW5HS1S120	403
JHW40201	493	JHW42304A	493	JHW4A-622	289	JHW50662B	203	JHW5HS1S60	404
JHW40221	368	JHW4-2F	293	JHW4A-622-2	289	JHW50663	232	JHW5HS2S100	404
JHW40222	369	JHW4-33B	293	JHW4A-624	289	JHW50664	231	JHW5HS2S200	404
JHW40223	369	JHW4-35B	293	JHW4A-624-2	289	JHW50665	232	JHW5HS2S35	404
JHW40224	369	JHW43603	370	JHW4A-628	289	JHW50666	231	JHW6004-TC	59
JHW40251	493	JHW43605	370	JHW4A-628-2	289	JHW50667	271	JHW608SC	144
JHW40252	503	JHW43607	370	JHW4M04T	419	JHW50668	271	JHW6-0XS	309
JHW40253	503	JHW43611	370	JHW4M10T	419	JHW50669	271	JHW6-107	309
JHW40254	503	JHW43613	370	JHW4M-610	297	JHW50671	230	JHW6-110	309
JHW40255	503	JHW43615	370	JHW4M-611	297	JHW50672B	203	JHW6-113	309
JHW40256	503	JHW43617	370	JHW4M-612	297	JHW50673	232	JHW612SC	144
JHW40257	503	JHW43618	370	JHW4M-613	297	JHW50681	202	JHW6-140B	309
JHW4-102	293	JHW43619	370	JHW4M-614	297	JHW50721A	50	JHW614SC	144
JHW4-105A	293	JHW43621	369	JHW4M-615	297	JHW50722A	50	JHW616SC	144
JHW4-110A	293	JHW43631	369	JHW4M-616	297	JHW50723A	50	JHW618SC	144
JHW41144	325	JHW4-53B	293	JHW4M-617	297	JHW50950B	51	JHW6-1A	309
JHW41146	325	JHW4-6	293	JHW4M-618	297	JHW50951B	51	JHW6-1XS	309
JHW41148	325	JHW4-612	294	JHW4M-619	297	JHW50952B	51	JHW620SC	144
JHW41150	325	JHW4-614	294	JHW4M-620	297	JHW5102	502	JHW6223	348
JHW41152	325	JHW4-616	294	JHW4M-621	297	JHW5103	502	JHW6224	348
JHW41154	325	JHW4-618	294	JHW4M-622	297	JHW527D-6	350	JHW6225	348
JHW41156	325	JHW4-620	294	JHW4M-623	297	JHW55100SPG	415	JHW622SC	144
JHW41158	325	JHW4-622	294	JHW4M-624	297	JHW55TAP	415	JHW624SC	144
JHW41160	325	JHW4-624	294	JHW4M-625	297	JHW55TKSA	415	JHW626SC	144
JHW41162	325	JHW4-626	294	JHW4M-626	297	JHW5AD150M	406	JHW628SC	144
JHW41164	325	JHW4-628	294	JHW4M-627	297	JHW5AS150	406	JHW6-2B	309
JHW41166	325	JHW4-630	294	JHW4M-629	297	JHW5AS150L	406	JHW6-2C	309
JHW41168	325	JHW4-632	294	JHW4M-630	297	JHW5AS200	406	JHW6-2XS	309
JHW41170	325	JHW4-634	294	JHW4M-632	297	JHW5AS380	406	JHW630SC	144
JHW41172	325	JHW4-636	294	JHW4M-634	297	JHW5AS380L	406	JHW632SC	144
JHW41174	325	JHW4-638	294	JHW4M-636	297	JHW5AS60	406	JHW6-3XS	309
JHW41176	325	JHW4-640	294	JHW4T06T	417	JHW5D73H10G	413	JHW640SC	144
JHW41178	325	JHW4-642	294	JHW4T10T	417	JHW5E05H1G	409	JHW6-4A	309

Product Code	Page #	Product Code	Page #	Product Code	Page #	Product Code	Page #	Product Code	Page #
JHW6-4XS	309	JHW6C15T10	392	JHW6CH30T06	399	JHW6M-624A	313	JHW7-1262	322
JHW6-5XS	309	JHW6C15T12	392	JHW6CH60T03	399	JHW6M-627A	313	JHW7-1264	322
JHW6-618A	310	JHW6C15T14	392	JHW6CL10T01	402	JHW6M-630	313	JHW7-1266	322
JHW6-620A	310	JHW6C25T01	392	JHW6CL20T02	402	JHW6M-631	313	JHW7-1268	322
JHW6-622A	310	JHW6C25T02	392	JHW6CL30T02	402	JHW6M-632	313	JHW7-1270	322
JHW6-624A	310	JHW6C25T04	392	JHW6CL50T02	402	JHW6M-634	313	JHW7-1272	322
JHW6-626A	310	JHW6C25T06	392	JHW6CN100T02	395	JHW6M-635	313	JHW7-1274	322
JHW6-628A	310	JHW6C25T08	392	JHW6CN100T04	395	JHW6M-636	313	JHW7-1276	322
JHW6-630A	310	JHW6C25T10	392	JHW6CN100T06	395	JHW6M-638	313	JHW7-1278	322
JHW6-632A	310	JHW6C25T12	392	JHW6CN100T08	395	JHW6M-641	313	JHW7-1280	322
JHW6-634A	310	JHW6C25T14	392	JHW6CN100T10	395	JHW6M-646	313	JHW7-1282	322
JHW6-636	310	JHW6C30T08	392	JHW6CN100T12	395	JHW6S.5T03	418	JHW7-1284	322
JHW6-638	310	JHW6C55T02	392	JHW6CN55T02	395	JHW6S01T03	418	JHW7-1286	322
JHW6-640	310	JHW6C55T04	392	JHW6CN55T04	395	JHW7029B	169	JHW7-1288	322
JHW6-642	310	JHW6C55T06	392	JHW6CN55T06	395	JHW7029B-TH	101	JHW7-1290	322
JHW6-644	310	JHW6C55T13	392	JHW6CN55T08	395	JHW7033C	169	JHW7-1292	322
JHW6-646	310	JHW6C75T06	392	JHW6CN55T10	395	JHW7033C-TH	101	JHW7-1294	322
JHW6-648	310	JHW6C75T13	392	JHW6CN55T12	395	JHW7038	169	JHW7-1296	322
JHW6-650	310	JHW6CA100T02	396	JHW6CP02T05	400	JHW7038-TH	101	JHW7-1298	322
JHW6-652	310	JHW6CA100T04	396	JHW6CP05T05	400	JHW7039B	169	JHW7-140B	319
JHW6-654	310	JHW6CA100T06	396	JHW6CP10T06	400	JHW7039B-TH	101	JHW7-1B	320
JHW6-656	310	JHW6CA100T10	396	JHW6CT10T06	401	JHW7-107	319	JHW7-1C	325
JHW6-658	310	JHW6CA30T02	396	JHW6CT10T10	401	JHW7-113	319	JHW7-1XS	320
JHW6-660	310	JHW6CA30T04	396	JHW6M-1219	313	JHW7-12100	322	JHW7-2F	320
JHW6-662	310	JHW6CA30T06	396	JHW6M-1220	313	JHW7-12104	322	JHW7-2XS	320
JHW6-664	310	JHW6CA50T02	396	JHW6M-1221	313	JHW7-12108	322	JHW7-3XS	320
JHW6-666	310	JHW6CA50T04	396	JHW6M-1222	313	JHW7-12112	322	JHW7-4XS	320
JHW6-670	310	JHW6CA50T06	396	JHW6M-1223	313	JHW7-12116	322	JHW7-5XS	320
JHW6-672	310	JHW6CA50T10	396	JHW6M-1224	313	JHW7-12120	322	JHW7-6	319
JHW6-676	310	JHW6CA75T04	396	JHW6M-1225	313	JHW7-12124	322	JHW7-6100	321
JHW6-6XS	309	JHW6CA75T06	396	JHW6M-1226	313	JHW7-12128	322	JHW7-6104	321
JHW6-7	309	JHW6CD100T06	394	JHW6M-1227	313	JHW7-12132	322	JHW7-6108	321
JHW6C05T00	390	JHW6CD100T13	394	JHW6M-1228	313	JHW7-12136	322	JHW7-6112	321
JHW6C05T01	390	JHW6CD100T18	394	JHW6M-1229	313	JHW7-12144	322	JHW7-6116	321
JHW6C05T03	390	JHW6CD10T10	394	JHW6M-1230	313	JHW7-1224	322	JHW7-6118	321
JHW6C05T05	390	JHW6CD10T12	394	JHW6M-1231	313	JHW7-1226	322	JHW7-6120	321
JHW6C05T07	390	JHW6CD30T08	394	JHW6M-1232	313	JHW7-1228	322	JHW7-6122	321
JHW6C05T09	390	JHW6CD30T15	394	JHW6M-1233	313	JHW7-1230	322	JHW7-6124	321
JHW6C100T06	392	JHW6CD55T06	394	JHW6M-1234	313	JHW7-1232	322	JHW7-6126	321
JHW6C100T10	392	JHW6CD55T13	394	JHW6M-1235	313	JHW7-1234	322	JHW7-6128	321
JHW6C10T01	390	JHW6CD55T20	394	JHW6M-1236	313	JHW7-1236	322	JHW7-6130	321
JHW6C10T02	390	JHW6CD75T06	394	JHW6M-1238	313	JHW7-1238	322	JHW7-6132	321
JHW6C10T04	390	JHW6CD75T13	394	JHW6M-1240	313	JHW7-1240	322	JHW7-6134	321
JHW6C10T06	390	JHW6CF05T03	397	JHW6M-1241	313	JHW7-1242	322	JHW7-6136	321
JHW6C10T08	390	JHW6CF10T05	397	JHW6M-1242	313	JHW7-1244	322	JHW7-6138	321
JHW6C10T10	390	JHW6CF20T05	397	JHW6M-1243	313	JHW7-1246	322	JHW7-6140	321
JHW6C10T12	390	JHW6CF30T05	397	JHW6M-1244	313	JHW7-1248	322	JHW7-6142	321
JHW6C10T14	390	JHW6CF50T05	397	JHW6M-1246	313	JHW7-1250	322	JHW7-6144	321
JHW6C15T01	392	JHW6CH100T03	399	JHW6M-1250	313	JHW7-1252	322	JHW7-6146	321
JHW6C15T02	392	JHW6CH12T03	399	JHW6M-617A	313	JHW7-1254	322	JHW7-6148	321
JHW6C15T04	392	JHW6CH20T02	399	JHW6M-619A	313	JHW7-1256	322	JHW7-6152	321
JHW6C15T06	392	JHW6CH20T06	399	JHW6M-620A	313	JHW7-1258	322	JHW7-6156	321
JHW6C15T08	392	JHW6CH30T02	399	JHW6M-622A	313	JHW7-1260	322	JHW7-6160	321

Product Code	Page #	Product Code	Page #	Product Code	Page #	Product Code	Page #	Product Code	Page #
JHW7-6172	321	JHW7M-632	324	JHW8-656	326	JHW8811BW	183	JHW8907	179
JHW7-6184	321	JHW7M-635	324	JHW8-658	326	JHW8811BW-TH	106	JHW8907A	179
JHW7-624	321	JHW7M-638	324	JHW8-660	326	JHW8811W	183	JHW8908	179
JHW7-626	321	JHW7M-641	324	JHW8-664	326	JHW8811W-TH	106	JHW8908A	179
JHW7-628	321	JHW7M-646	324	JHW8-666	326	JHW8812AW	183	JHW8909	179
JHW7-630	321	JHW7M-650	324	JHW8-668	326	JHW8812AW-TH	106	JHW8909A	179
JHW7-632	321	JHW7M-660	324	JHW8-670	326	JHW8812BW	183	JHW8910	179
JHW7-634	321	JHW7M-665	324	JHW8-672	326	JHW8812BW-TH	106	JHW8910A	179
JHW7-636	321	JHW7M-670	324	JHW8-676	326	JHW8812W	183	JHW8911	179
JHW7-638	321	JHW7M-675	324	JHW8-678	326	JHW8812W-TH	106	JHW8911A	179
JHW7-640	321	JHW8033A	171	JHW8-680	326	JHW8813AW	183	JHW8912	179
JHW7-642	321	JHW8033C	171	JHW8-682	326	JHW8813AW-TH	106	JHW8913	179
JHW7-644	321	JHW8-108	325	JHW8-684	326	JHW8813BW	183	JHW8914	179
JHW7-646	321	JHW8-115	325	JHW8-688	326	JHW8813BW-TH	106	JHW8915	179
JHW7-648	321	JHW8-140B	325	JHW8-692	326	JHW8813W	183	JHW8916	179
JHW7-650	321	JHW8-1XS	325	JHW8-694	326	JHW8813W-TH	106	JHW8FB25F38M	420
JHW7-652	321	JHW8-20	325	JHW8-696	326	JHW8814AW	183	JHW8FC25F38F	421
JHW7-654	321	JHW8231	348	JHW8-698	326	JHW8814AW-TH	106	JHW8FC38F	421
JHW7-656	321	JHW8-2E	325	JHW8-7	325	JHW8814W	183	JHW8FG38MF	420
JHW7-658	321	JHW8-2XS	325	JHW8720	171	JHW8814W-TH	106	JHW8FN25M	421
JHW7-660	321	JHW8-3XS	325	JHW8723	171	JHW8815AW	183	JHW8FN25M38M	421
JHW7-662	321	JHW8-4XS	325	JHW8725	171	JHW8815AW-TH	106	JHW8FN38M	421
JHW7-664	321	JHW8-6100	326	JHW8725B	171	JHW8815BW	183	JHW8FR38M25F	420
JHW7-666	321	JHW8-6104	326	JHW8727	171	JHW8815BW-TH	106	JHW8G025W	420
JHW7-668	321	JHW8-6108	326	JHW8727A	171	JHW8815W	183	JHW8G04W	420
JHW7-670	321	JHW8-6110	326	JHW8729	171	JHW8815W-TH	106	JHW8H1G	420
JHW7-672	321	JHW8-6112	326	JHW8729A	171	JHW8816BW	183	JHW8H2525D06	420
JHW7-674	321	JHW8-6116	326	JHW8731A	171	JHW8816BW-TH	106	JHW8H2538D06	420
JHW7-676	321	JHW8-6120	326	JHW8-8	325	JHW8816CW	183	JHW8H3825D06	420
JHW7-678	321	JHW8-6122	326	JHW8807AW	183	JHW8816CW-TH	106	JHW8H3825D10	420
JHW7-680	321	JHW8-6124	326	JHW8807AW-TH	106	JHW8816W	183	JHW8H3825D20	420
JHW7-682	321	JHW8-6128	326	JHW8807W	183	JHW8816W-TH	106	JHW8H3838D06	420
JHW7-684	321	JHW8-6132	326	JHW8807W-TH	106	JHW8817AW	183	JHW8H3838D10	420
JHW7-686	321	JHW8-6136	326	JHW8808AW	183	JHW8817AW-TH	106	JHW8H3838D20	420
JHW7-688	321	JHW8-6138	326	JHW8808AW-TH	106	JHW8817W	183	JHW8M14L7P	422
JHW7-690	321	JHW8-6140	326	JHW8808BW	183	JHW8817W-TH	106	JHW8M7L7P	422
JHW7-692	321	JHW8-6144	326	JHW8808BW-TH	106	JHW8818AW	183	JHW8R38D	421
JHW7-694	321	JHW8-6148	326	JHW8808CW	183	JHW8818AW-TH	106	JHW8R38DF	421
JHW7-696	321	JHW8-6152	326	JHW8808CW-TH	106	JHW8818W	183	JHW8R38DM	421
JHW7-6XS	320	JHW8-6156	326	JHW8808W	183	JHW8818W-TH	106	JHW8RH38D	421
JHW7723	169	JHW8-6160	326	JHW8808W-TH	106	JHW8819AW	183	JHW8RH38DF	421
JHW7723-TH	101	JHW8-6172	326	JHW8809AW	183	JHW8819AW-TH	106	JHW8RH38DM	421
JHW7725B	169	JHW8-6184	326	JHW8809AW-TH	106	JHW8819BW	183	JHW8V38N	422
JHW7725B-TH	101	JHW8-6196	326	JHW8809BW	183	JHW8819BW-TH	106	JHW8V38R	422
JHW7727A	169	JHW8-6208	326	JHW8809BW-TH	106	JHW8819CW	183	JHW9-1D	325
JHW7727A-TH	101	JHW8-6220	326	JHW8809W	183	JHW8819CW-TH	106	JHW9-2G	325
JHW7731A	169	JHW8-6232	326	JHW8809W-TH	106	JHW8819W	183	JHW9A55T06	415
JHW7731A-TH	101	JHW8-6244	326	JHW8810AW	183	JHW8819W-TH	106	JHW9A55T13	415
JHW7731B	169	JHW8-6256	326	JHW8810AW-TH	106	JHW88SET-TH	106	JHW9E100T10	415
JHW7731B-TH	101	JHW8-646	326	JHW8810W	183	JHW8905	179	JHW9E55T06	415
JHW7-8	319	JHW8-648	326	JHW8810W-TH	106	JHW8905A	179	JHW9E55T13	415
JHW7M-627	324	JHW8-652	326	JHW8811AW	183	JHW8906	179	JHW9H55T06	415
JHW7M-630	324	JHW8-654	326	JHW8811AW-TH	106	JHW8906B	179	JHWADVMNT	27

Product Code	Page #	Product Code	Page #	Product Code	Page #	Product Code	Page #	Product Code	Page #
JHWADVMNTTB	27	JHWB-616	237	JHWBCF32	239	JHWBITH03T01	249	JHWBITHB0801	211
JHWB-101	234	JHWB-618	237	JHWBCF34	239	JHWBITH0401	210	JHWBITHB0802	249
JHWB-108	234	JHWB-620	237	JHWBCO12	240	JHWBITH0402	211	JHWBITHB1001	249
JHWB-108-TH	111	JHWB-622	237	JHWBCO14	240	JHWBITH0403	249	JHWBITHB1201	249
JHWB-110	234	JHWB-624	237	JHWBCO16	240	JHWBITH0404	250	JHWBITHB4501	249
JHWB-110-TH	111	JHWB-626	237	JHWBCO18	240	JHWBITH05001	210	JHWBITHS01	250
JHWB-115	234	JHWB-628	237	JHWBCO20	240	JHWBITH0501	210	JHWBITHS02	250
JHWB-115-TH	111	JHWB-630	237	JHWBCO22	240	JHWBITH0502	211	JHWBITHS03	250
JHWB-118	234	JHWB-632	237	JHWBCO24	240	JHWBITH0503	249	JHWBITHS04	288
JHWB-118-TH	111	JHWB-70	234	JHWBCO26	240	JHWBITH0504	250	JHWBITHS05	288
JHWB-1208	236	JHWB-70-TH	111	JHWBCO28	240	JHWBITH0601	210	JHWBITPH0102	250
JHWB-1210	236	JHWBA-10A	249	JHWBCO30	240	JHWBITH0602	211	JHWBITPH0202	250
JHWB-1211	236	JHWBA-10A-3P	250	JHWBCO32	240	JHWBITH0603	249	JHWBITPH0302	250
JHWB-1212	236	JHWBA-10A-3S	250	JHWBCO40	240	JHWBITH0604	250	JHWBITPH0401	288
JHWB-1214	236	JHWBA-10A-4S	250	JHWBCO44	240	JHWBITH0701	210	JHWBM-1206	244
JHWB-1216	236	JHWBA-10HBA	249	JHWBCOM10	240	JHWBITH0702	211	JHWBM-1207	244
JHWB-1217	236	JHWBA-10LA	250	JHWBCOM11	240	JHWBITH0703	249	JHWBM-1208	244
JHWB-1218	236	JHWBA-12A	249	JHWBCOM12	240	JHWBITH0704	250	JHWBM-1209	244
JHWB-1219	236	JHWBA-12A-4P	250	JHWBCOM13	240	JHWBITH0801	210	JHWBM-1210	244
JHWB-1220	236	JHWBA-12HBA	249	JHWBCOM14	240	JHWBITH0802	211	JHWBM-1211	244
JHWB-1222	236	JHWBA-12LA	250	JHWBCOM15	240	JHWBITH0803	249	JHWBM-1212	244
JHWB-1224	236	JHWBA-3A	249	JHWBCOM16	240	JHWBITH0804	250	JHWBM-1213	244
JHWB-1226	236	JHWBA-3HBA	249	JHWBCOM17	240	JHWBITH0805	287	JHWBM-1214	244
JHWB-1228	236	JHWBA-3LA	250	JHWBCOM18	240	JHWBITH0806	287	JHWBM-1215	244
JHWB-1230	236	JHWBA-4A	249	JHWBCOM19	240	JHWBITH1001	249	JHWBM-1216	244
JHWB-1232	236	JHWBA-4HBA	249	JHWBCOM20	240	JHWBITH1002	211	JHWBM-1217	244
JHWB-140A	234	JHWBA-4LA	250	JHWBCOM21	240	JHWBITH1004	250	JHWBM-1218	244
JHWB-140A-TH	111	JHWBA-5A	249	JHWBCOM22	240	JHWBITH1005	287	JHWBM-1219	244
JHWB-15	234	JHWBA-5A-1S	250	JHWBD-1208	242	JHWBITH1006	287	JHWBM-1220	244
JHWB-201	235	JHWBA-5HBA	249	JHWBD-1210	242	JHWBITH1201	249	JHWBM-1221	244
JHWB-203	235	JHWBA-5LA	250	JHWBD-1212	242	JHWBITH1202	250	JHWBM-1222	244
JHWB-206	235	JHWBA-6A	249	JHWBD-1214	242	JHWBITH1203	287	JHWBM-1223	244
JHWB-208	235	JHWBA-6HBA	249	JHWBD-1216	242	JHWBITH1204	287	JHWBM-1224	244
JHWB-20A	234	JHWBA-6LA	250	JHWBD-1218	242	JHWBITH1601	287	JHWBM-1226	244
JHWB-211	235	JHWBA-7A	249	JHWBD-1220	242	JHWBITH1602	287	JHWBM-605.5	244
JHWB-218	235	JHWBA-7A-1P	250	JHWBD-1222	242	JHWBITH1801	287	JHWBM-606	244
JHWB-409	238	JHWBA-7A-2P	250	JHWBD-1224	242	JHWBITH1802	287	JHWBM-607	245
JHWB-40A-TH	111	JHWBA-7A-2S	250	JHWBD-1226	242	JHWBITH2.501	210	JHWBM-608	245
JHWB-40B	234	JHWBA-7HBA	249	JHWBD-1228	242	JHWBITH2001	287	JHWBM-609	245
JHWB-52A	233	JHWBA-7LA	250	JHWBD-1230	242	JHWBITH2002	287	JHWBM-610	245
JHWB-52ARK	233	JHWBA-8A	249	JHWBD-1232	242	JHWBITH3.501	210	JHWBM-611	245
JHWB-52EHA	233	JHWBA-8HBA	249	JHWBD-808	238	JHWBITH3.502	211	JHWBM-612	245
JHWB52EHATH	111	JHWBA-8LA	250	JHWBD-810	238	JHWBITH4.501	210	JHWBM-613	245
JHWB-52EHFB	233	JHWBB-526	238	JHWBD-812	238	JHWBITH4.502	211	JHWBM-614	245
JHWB-52EHLA	233	JHWBB-52A	233	JHWBD-814	238	JHWBITHB0301	211	JHWBM-615	245
JHWB52EHLATH	111	JHWBB-52EHA	233	JHWBD-816	238	JHWBITHB0401	211	JHWBM-616	245
JHWB-52EHRKA	233	JHWBB52EHATH	111	JHWBD-818	238	JHWBITHB0402	211	JHWBM-617	245
JHWB-53A	233	JHWBCF20	239	JHWBD-820	238	JHWBITHB0501	211	JHWBM-618	245
JHWB-608	237	JHWBCF22	239	JHWBFE-8	234	JHWBITHB0502	249	JHWBM-619	245
JHWB-610	237	JHWBCF24	239	JHWBHMD-30	253	JHWBITHB0601	211	JHWBM-620	245
JHWB-611	237	JHWBCF26	239	JHWBITH0201	210	JHWBITHB0602	249	JHWBM-621	245
JHWB-612	237	JHWBCF28	239	JHWBITH0301	210	JHWBITHB0701	211	JHWBM-622	245
JHWB-614	237	JHWBCF30	239	JHWBITH0302	211	JHWBITHB0702	249	JHWBM-623	245

Product Code	Page #	Product Code	Page #	Product Code	Page #	Product Code	Page #	Product Code	Page #
JHWBM-624	245	JHWBWM-1213	170	JHWC-715	386	JHWCC-412S	365	JHWELECTRICALTB	33
JHWBM-626	245	JHWBWM-1214	170	JHWC-718	386	JHWCC-4AAW	365	JHWEWM-0607	163
JHWBMD-606	246	JHWBWM-1315	170	JHWC-72	382	JHWCC-4LAAW	365	JHWEWM-0708	163
JHWBMD-607	246	JHWBWM-1415	170	JHWC-73	382	JHWCC-5AAW	365	JHWEWM-0910	163
JHWBMD-608	246	JHWBWM-1417	170	JHWC-74	382	JHWCC-5LAAW	365	JHWEWM-1011	163
JHWBMD-609	246	JHWBWM-1618	170	JHWC-75	382	JHWCC-6AAW	365	JHWEWM-1213	163
JHWBMD-610	246	JHWBWM-1719	170	JHWC-8	381	JHWCC-6LAAW	365	JHWEWM-1415	163
JHWBMD-611	246	JHWBWM-1821	170	JHWC-80	386	JHWCC-8AAW	365	JHWEWM-1618	163
JHWBMD-612	246	JHWBWM-1922	170	JHWC-803	385	JHWCC-8LAAW	365	JHWEWM-1719	163
JHWBMD-613	246	JHWBWM-2124	170	JHWC-807	385	JHWCP05T	421	JHWEWM-2124	163
JHWBMD-614	246	JHWBWM-2224	170	JHWC-80A	386	JHWCP15T	421	JHWEWM-2224	163
JHWBMD-615	246	JHWBWM-2427	170	JHWC-812	385	JHWCP25T	421	JHWEWM-2427	163
JHWBMD-616	246	JHWBWM-2730	170	JHWC-818	385	JHWCPB05T	421	JHWEWM-2730	163
JHWBMD-617	246	JHWBWM-3032	170	JHWC-82	386	JHWCPB10T	421	JHWEWM3032	163
JHWBMD-618	246	JHWC-10	381	JHWC-824	385	JHWCS-8	379	JHWEX-21A	496
JHWBMD-619	246	JHWC-100	385	JHWC-82A	386	JHWCS-9	379	JHWEX-21B	496
JHWBMD-620	246	JHWC-101	385	JHWC-83	386	JHWCW-4	369	JHWEX-22A	496
JHWBMD-622	246	JHWC-102	385	JHWC-836	385	JHWCW-4-TH	126	JHWEX-24A	496
JHWBMD-623	246	JHWC-103	385	JHWC-83-TH	132	JHWDTB-6	235	JHWEX-25A	496
JHWBMD-624	246	JHWC-10-TH	130	JHWC-84	386	JHWDTM-6	206	JHWEX-25B	496
JHWBMD-625	246	JHWC-12	381	JHWC-842	385	JHWDTS-6	275	JHWEX-26A	496
JHWBP3410TH	121	JHWC-120	382	JHWC-84-TH	132	JHWEB-10T	494	JHWEX-28	496
JHWBP3410TH	121	JHWC-124	382	JHWC-85	386	JHWEB-11T	494	JHWEX-29	496
JHWBP4014TH	121	JHWC-125	382	JHWC-858	385	JHWEB-12T	494	JHWEXS-10	496
JHWBP4014TH	121	JHWC-126	382	JHWC-86	386	JHWEB-14T	494	JHWEXS-30	496
JHWBS-05B	274	JHWC-12-TH	130	JHWC-90	385	JHWEB-15T	494	JHWFJ-20	368
JHWBS-12B	274	JHWC-132	382	JHWC-91	385	JHWEB-16T	494	JHWFJ-30	368
JHWBS-130	234	JHWC-133	382	JHWC-92	385	JHWEB-17T	494	JHWGMNT	31
JHWBS-130B	234	JHWC-15	381	JHWC-93	385	JHWEB-1T	494	JHWGMNTTB	31
JHWBS-131BF	234	JHWC-15-TH	130	JHWCC-10AAW	365	JHWEB-21T	494	JHWGS-1	496
JHWBS-41AA	273	JHWC-16	381	JHWCC-10LAAW	365	JHWEB-22T	494	JHWGS-1-TH	135
JHWBS41AATH	114	JHWC-16-TH	130	JHWCC11/2AAW	365	JHWEB-23T	494	JHWGS-2	496
JHWBS-52A	272	JHWC-20	381	JHWCC-12AAW	365	JHWEB-24T	494	JHWGS-3	496
JHWBS-62	114	JHWC-20-TH	130	JHWCC-12LAAW	365	JHWEB-25T	494	JHWGS-3-TH	135
JHWBS-63B	114	JHWC-24	381	JHWCC-1AAW	365	JHWEB-26T	494	JHWGS-4	496
JHWBS-63BBAR	114	JHWC-24-TH	130	JHWCC-2AAW	365	JHWEB-27T	494	JHWGSC-12	482
JHWBS-63BRK	114	JHWC-28	381	JHWCC-3AAW	365	JHWEB-28T	494	JHWH-104	305
JHWBS-63BTIP	114	JHWC-32	381	JHWCC-3LAAW	365	JHWEB-29T	494	JHWH-104B	305
JHWBS-71ARKA	273	JHWC-32-TH	130	JHWCC-402C	365	JHWEB-2T	494	JHWH-104B-TH	118
JHWBS-71CBA	273	JHWC-36	381	JHWCC402CTH	125	JHWEB-30T	494	JHWH-110	305
JHWBTHB03T01	249	JHWC-40	382	JHWCC-402S	365	JHWEB-31T	494	JHWH-110B	305
JHWBU-1212	238	JHWC-42	382	JHWCC-404C	365	JHWEB-32T	494	JHWH-110B-TH	118
JHWBU-1214	238	JHWC-422	382	JHWCC404CTH	125	JHWEB-34T	494	JHWH-110-TH	118
JHWBU-1216	238	JHWC-42-TH	130	JHWCC-404S	365	JHWEB-35T	494	JHWH-115	305
JHWBU-1218	238	JHWC-44	382	JHWCC-406C	365	JHWEB-36T	494	JHWH-115B	305
JHWBU-1220	238	JHWC-46	382	JHWCC406CTH	125	JHWEB-3T	494	JHWH-115-TH	118
JHWBU-1222	238	JHWC-60	382	JHWCC406CTH	125	JHWEB-4T	494	JHWH-1224	306
JHWBU-1224	238	JHWC-612	386	JHWCC-406S	365	JHWEB-5T	494	JHWH-1226	306
JHWBWM-0810	170	JHWC-616	386	JHWCC-408C	365	JHWEB-6T	494	JHWH-1228	306
JHWBWM0810TH	102	JHWC-62	382	JHWCC-408S	365	JHWEB-7T	494	JHWH-1230	306
JHWBWM-1011	170	JHWC-621	386	JHWCC-410C	365	JHWEB-8T	494	JHWH-1231	306
JHWBWM-1012	170	JHWC-62-TH	130	JHWCC-410S	365	JHWEB-9T	494	JHWH-1232	306
JHWBWM-1113	170	JHWC-709	386	JHWCC-412C	365	JHWELECTRICAL	33	JHWH-1234	306

Product Code	Page #	Product Code	Page #	Product Code	Page #	Product Code	Page #	Product Code	Page #
JHWISSXM616	292	JHWISXTD612A	290	JHWMA-3HBA	211	JHWMD-616	208	JHWMS-2-13H	256
JHWISSXM618	292	JHWISXTM1013	291	JHWMA-3LA	211	JHWMD-618	208	JHWMS410HRC	297
JHWISSXM910	291	JHWISXTM1016	292	JHWMA-4-1/2A	210	JHWMECMNT	26	JHWMS4-12HRC	297
JHWISSXM912	291	JHWISXTM1018	292	JHWMA41/2HBA	211	JHWMECMNTTB	26	JHWMS-4-16RC	297
JHWISSXM913	291	JHWISXTM1216	292	JHWMA4-1/2LA	211	JHWMEGA	18	JHWMS-4-23RC	297
JHWISSXM915	292	JHWJHW-16	374	JHWMA-4A	210	JHWMEGAMM	18	JHWMS-6-8H	313
JHWISSXM916	292	JHWJHW-24	374	JHWMA-4HBA	211	JHWMEGASAE	18	JHWMSB-12HRC	245
JHWISSXM918	292	JHWJHW-32	374	JHWMA-4LA	211	JHWMEGATB	18	JHWMSB-12RC	244
JHWISSXMD416	292	JHWJHW-48	374	JHWMA-4SA	212	JHWMF6-6	205	JHWMSB-16F	221
JHWISSXT1218	290	JHWJHW-56	374	JHWMA-5A	210	JHWMD10A	152	JHWMSB-16FTB	221
JHWISSXT1230	290	JHWLLED-150	501	JHWMA-5HBA	211	JHWMD12A	152	JHWMSB-17F	220
JHWISSXT312	290	JHWM-102	205	JHWMA-5LA	211	JHWMD14A	152	JHWMSB-17FTB	220
JHWISSXT314	290	JHWM-102-TH	109	JHWMA-5SA	212	JHWMD65A	152	JHWMSB-17RC	244
JHWISSXT316	290	JHWM-104	205	JHWMA-6A	210	JHWMD75A	152	JHWMSB-18HF	220
JHWISSXT320	290	JHWM-104-TH	109	JHWMA-6HBA	211	JHWMD7A	152	JHWMSB18HFTB	220
JHWISSXT324	290	JHWM-106A	204	JHWMA-6LA	211	JHWMD8A	152	JHWMSB-20HRC	245
JHWISSXT412	290	JHWM-110	205	JHWMA-6SA	212	JHWMD9A	152	JHWMSB-20RC	244
JHWISSXT414	290	JHWM-115	205	JHWMA-7A	210	JHWMD54A	152	JHWMSB-29F	219
JHWISSXT416	290	JHWM-115-TH	109	JHWMA-7HBA	211	JHWMD55A	152	JHWMSB-29FTB	219
JHWISSXT418	290	JHWM-1208	206	JHWMA-7LA	211	JHWMD56A	152	JHWMSB-29HF	219
JHWISSXT420	290	JHWM-1210	206	JHWMA-8A	210	JHWMM-604	208	JHWMSB29HFTB	219
JHWISSXT424	290	JHWM-1211	206	JHWMA-8HBA	211	JHWMM-605	208	JHWMSB-39F	218
JHWISSXT430	290	JHWM-1212	206	JHWMA-8LA	211	JHWMM-605.5	208	JHWMSB-39FTB	218
JHWISSXT614	290	JHWM-1214	206	JHWMAMMOTH	16	JHWMM-606	208	JHWMSBD12HRC	246
JHWISSXT616	290	JHWM-1216	206	JHWMAMMOTHMM	16	JHWMM-607	208	JHWMSBD19HRC	246
JHWISSXT618	290	JHWM-1218	206	JHWMAMMOTHSAE	16	JHWMM-608	208	JHWMSH-15RC	308
JHWISSXT620	290	JHWM-124	205	JHWMAMMOTHTB	16	JHWMM-609	208	JHWMSH-20	303
JHWISSXT624	290	JHWM-140A	205	JHWMMASTER	24	JHWMM-610	208	JHWMSH-20TB	303
JHWISSXT630	290	JHWM-140A-TH	109	JHWMMASTERTB	24	JHWMM-611	208	JHWMSM-12HRC	208
JHWISSXT912	290	JHWM-15A	204	JHWMAXXUM	20	JHWMM-612	208	JHWMSM-17HF	196
JHWISSXT914	290	JHWM-202	206	JHWMAXXUMMM	20	JHWMM-613	208	JHWMSM17HFTB	196
JHWISSXT916	290	JHWM-203	206	JHWMAXXUMSAE	20	JHWMM-614	208	JHWMSM-30HF	196
JHWISSXT918	290	JHWM-206	206	JHWMAXXUMTB	20	JHWMMD-604	209	JHWMSM30HFTB	196
JHWISSXT920	290	JHWM-211	206	JHWMB-130	205	JHWMMD-605	209	JHWMSMD12HRC	209
JHWISSXT924	290	JHWM-42A	204	JHWMB-130B	205	JHWMMD-605.5	209	JHWMS-15RC	282
JHWISSXT930	290	JHWM-42RK	204	JHWMB-131BA	205	JHWMMD-606	209	JHWMS-15SRC	282
JHWISSXTM410	292	JHWM-52A	204	JHWMB-52EHA	204	JHWMMD-607	209	JHWMS-20FTB	266
JHWISSXTM412	291	JHWM-52ARK	204	JHWMB52EHATH	109	JHWMMD-608	209	JHWMS-22F	265
JHWISSXTM413	291	JHWM-52EHA	204	JHWMD-1210	207	JHWMMD-609	209	JHWMS-22FTB	265
JHWISSXTM415	292	JHWM52EHATH	109	JHWMD-1211	207	JHWMMD-610	209	JHWMS-24RC	282
JHWISSXTM416	292	JHWM-52EHFA	204	JHWMD-1212	207	JHWMMD-611	209	JHWMS-29F	265
JHWISSXTM418	292	JHWM-52EHRKA	204	JHWMD-1214	207	JHWMMD-612	209	JHWMS-29FTB	265
JHWISSXTM612	291	JHWM-808	207	JHWMD-1216	207	JHWMMD-613	209	JHWMS-33F	264
JHWISSXTM613	291	JHWM-810	207	JHWMD-1218	207	JHWMMD-614	209	JHWMS-33FTB	264
JHWISSXTM615	291	JHWM-812	207	JHWMD-605	208	JHWMMNTCART	34	JHWMS-47F	264
JHWISSXTM616	292	JHWMA-050A	210	JHWMD-606	208	JHWMMNTCARTTB	34	JHWMS-47TB	264
JHWISSXTM618	292	JHWMA-10A	210	JHWMD-607	208	JHWMONSTER	22	JHWMSD-12RC	284
JHWISSXTM910	291	JHWMA-10LA	211	JHWMD-608	208	JHWMONSTERTB	22	JHWMS-10A	149
JHWISSXTM912	291	JHWMA-2-1/2A	210	JHWMD-609	208	JHWMS-12-13H	258	JHWMS10RCU	155
JHWISSXTM913	291	JHWMA-2A	210	JHWMD-610	208	JHWMS-12-18H	258	JHWMS10RS	154
JHWISSXTM915	291	JHWMA-3-1/2A	210	JHWMD-611	208	JHWMS1410HRC	299	JHWMS10RSS	155
JHWISSXTM916	292	JHWMA3-1/2LA	211	JHWMD-612	208	JHWMS-1416RC	299	JHWMS-1110	165
JHWISSXTM918	292	JHWMA-3A	210	JHWMD-614	208	JHWMS-1424RC	299	JHWMS-1115	165

Product Code	Page #	Product Code	Page #	Product Code	Page #	Product Code	Page #	Product Code	Page #
JHWMWS-12RC	157	JHWP-24	384	JHWPL-114CS	354	JHWPL-49C	352	JHWR-27A	54
JHWMWS-12RCF	161	JHWP-25	384	JHWPL116C	354	JHWPL-527	363	JHWR-28A	54
JHWMWS-12RCS	160	JHWP-25-TH	132	JHWPL-126C	354	JHWPL-528	363	JHWR-29A	54
JHWMWS-15A	149	JHWP-26	384	JHWPL126CTH	124	JHWPL-529	363	JHWR-2A	54
JHWMWS-15SA	149	JHWP-27	384	JHWPL-1300	358	JHWPL-529A	363	JHWR-30A	54
JHWMWS-18A	149	JHWP-28	384	JHWPL-146C	355	JHWPL-529B	363	JHWR-31A	54
JHWMWS-1B	149	JHWP-28A	384	JHWPL-149C	355	JHWPL-529C	363	JHWR-36A	54
JHWMWS-26	163	JHWP-28A-TH	132	JHWPL149CTH	123	JHWPL-529D	363	JHWR-37A	54
JHWMWS-27	188	JHWP-28-TH	132	JHWPL-1515	364	JHWPL-530A	363	JHWR-3A	54
JHWMWS-27TA	149	JHWP-29	384	JHWPL-1519C	348	JHWPL-530B	363	JHWR-41A	54
JHWMWS-30	173	JHWP-3	383	JHWPL1519CTH	122	JHWPL-530C	363	JHWR-42A	54
JHWMWS-31	163	JHWP-30	384	JHWPL-1520C	348	JHWPL-530D	363	JHWR-48A	54
JHWMWS-3510	168	JHWP-32	384	JHWPL1520CTH	122	JHWPL-531	364	JHWR-49A	54
JHWMWS-47	187	JHWP-32-TH	131	JHWPL-1523C	348	JHWPL-532	364	JHWR-4A	54
JHWMWS-47-TH	108	JHWP-38	384	JHWPL1523CTH	122	JHWPL-533	364	JHWR-5A	54
JHWMWS-4RC	157	JHWP-38-TH	131	JHWPL-1524C	348	JHWPL-534	364	JHWR-8A	54
JHWMWS-5A	149	JHWP-39	384	JHWPL1524CTH	122	JHWPL-57C	351	JHWR-8BLUE	54
JHWMWS-6A	149	JHWP-39-TH	131	JHWPL-1600C	362	JHWPL-57C-TH	123	JHWR-8RED	54
JHWMWS-BWM10	170	JHWP-4	383	JHWPL-1600C1	362	JHWPL-6C	349	JHWR-9	54
JHWMWS-BWM12	170	JHWP-40	384	JHWPL-1600C2	362	JHWPL-75C	354	JHWRB-1214	172
JHWMWSHKT-8	186	JHWP-40-TH	131	JHWPL-1600C3	362	JHWPL76C	354	JHWRB1214TH	103
JHWMWS-MS10	152	JHWP-42	384	JHWPL-1606	361	JHWPL-76C-TH	123	JHWRB-1618	172
JHWO-471	185	JHWP-42-TH	131	JHWPL-1612	361	JHWPL-77C	354	JHWRB1618TH	103
JHWO-471A	185	JHWP-4-TH	131	JHWPL-1620	361	JHWPL-8C	349	JHWRB-1820	172
JHWO-471-TH	105	JHWP-5	383	JHWPL-1621	361	JHWPL-8C-TH	122	JHWRB-2022	172
JHWO-472	185	JHWP-51	383	JHWPL-1622	361	JHWPL-95C	354	JHWRB2022TH	103
JHWO-472A	185	JHWP-52	383	JHWPL-1623	361	JHWPL-98C	353	JHWRB-2024	172
JHWO-472-TH	105	JHWP-53	383	JHWPL-1624	361	JHWPLM-1CS	351	JHWRB-2428	172
JHWO-474	185	JHWP-54	383	JHWPL-1625	361	JHWPLM-2C	350	JHWRB2428TH	103
JHWO-474A	185	JHWP-55	383	JHWPL-1626	361	JHWPLS-17	346	JHWRB-3036	172
JHWO-474A-TH	105	JHWP-56	383	JHWPL-1627	361	JHWPLS-4GL	347	JHWRB-3440	172
JHWO-474-TH	105	JHWP-57	383	JHWPL-1628	361	JHWPLS-4SG	347	JHWRB-42	171
JHWOES-0607	163	JHWP-58	383	JHWPL-1629	361	JHWPLS-6A	346	JHWRB-44	171
JHWOES-0809	163	JHWP-59	383	JHWPL-1630	361	JHWPS-12	380	JHWRB-46	171
JHWOES-1011	163	JHWP-6	383	JHWPL-1631	361	JHWPS-17	380	JHWRB-48	171
JHWOES-1214	163	JHWP-60	383	JHWPL-167	350	JHWPS-3A	384	JHWRB-50	171
JHWOES-1618	163	JHWP-61	383	JHWPL-204C	350	JHWPS-4	380	JHWRB-52	171
JHWOILFIELD	29	JHWP-62	383	JHWPL204CTH	122	JHWPS-8	381	JHWRB-54	171
JHWOILFIELDTB	29	JHWP-63A	384	JHWPL205C	350	JHWQ-208	179	JHWRB-56	171
JHWP-10	383	JHWP-64A	384	JHWPL-208	350	JHWQ-210	179	JHWRB-58	171
JHWP-10-TH	131	JHWP-65A	384	JHWPL-209	350	JHWR-10A	54	JHWRB-60	171
JHWP-12	383	JHWP-6-TH	131	JHWPL-209X	350	JHWR-11A	54	JHWRB-64	171
JHWP-13	383	JHWP-8	383	JHWPL-211BC	353	JHWR-13A	54	JHWRB-68	171
JHWP-14	383	JHWP-8-TH	131	JHWPL-211C	353	JHWR-13BLUE	54	JHWRB-810	172
JHWP-14-TH	131	JHWPBS-7	385	JHWPL-40CS	351	JHWR-13R	54	JHWRB-810-TH	103
JHWP-15	383	JHWP-17	378	JHWPL-411C	351	JHWR-13RED	54	JHWRBM-0708	173
JHWP-15-TH	131	JHWP-17-TH	129	JHWPL-44C	351	JHWR-17	54	JHWRBM-0910	173
JHWP-16	383	JHWP-27	378	JHWPL-45C	351	JHWR-18BLUE	54	JHWRBM-1112	173
JHWP-16-TH	131	JHWP-28	379	JHWPL-46C	351	JHWR-18RED	54	JHWRBM-1314	173
JHWP-17	383	JHWPETROSET	28	JHWPL-46C-TH	123	JHWR-1A	54	JHWRBM-1517	173
JHWP-17-TH	131	JHWPETROSETTB	28	JHWPL-47C	351	JHWR-20A	54	JHWRBM-1618	173
JHWP-18	383	JHWPL-10C	349	JHWPL-47C-TH	123	JHWR-23A	54	JHWRBM-1921	173
JHWP-18-TH	131	JHWPL-10C-TH	122	JHWPL-48C	352	JHWR-24A	54	JHWRBM-22	172

Product Code	Page #	Product Code	Page #	Product Code	Page #	Product Code	Page #	Product Code	Page #
JHWRBM-23	172	JHWS-211P	275	JHWSCF52	279	JHWSDE-43	337	JHWSFH1816BW	182
JHWRBM-24	172	JHWS-220P	275	JHWSCF54	279	JHWSDE-46	337	JHWSFH-1816W	182
JHWRBM-25	172	JHWS-40AA	273	JHWSCF56	279	JHWSDE-50	337	JHWSFH1817AW	182
JHWRBM-26	172	JHWS-40AA-TH	114	JHWSCF58	279	JHWSDE-53	337	JHWSFH-1817W	182
JHWRBM-27	172	JHWS-41AA	273	JHWSCF60	279	JHWSDE-8	337	JHWSFH1818AW	182
JHWRBM-29	172	JHWS-41AA-TH	114	JHWSCF62	279	JHWSDP-1-3	337	JHWSFH-1818W	182
JHWRBM-30	172	JHWS-41RK	273	JHWSCF64	279	JHWSDP13TH	121	JHWSFH1819AW	182
JHWRBM-32	172	JHWS-52A	272	JHWSOE30	278	JHWSDP-2-4	337	JHWSFH1819BW	182
JHWRBM-36	172	JHWS-52ARK	272	JHWSOE32	278	JHWSDP24TH	121	JHWSFH1819CW	182
JHWRBO-1214	173	JHWS-52EHA	272	JHWSOE34	278	JHWSDP-2-8	337	JHWSFH1819WA	182
JHWRBO-1618	173	JHWS52EHATH	114	JHWSOE36	278	JHWSDP28TH	121	JHWSFH1820BW	182
JHWRBO-2022	173	JHWS-52EHFA	272	JHWSOE38	278	JHWSDP-2-ST	337	JHWSFH1820WA	182
JHWRBO-2024	173	JHWS-52EHLA	272	JHWSOE40	278	JHWSDP2STTH	121	JHWSH-10A	377
JHWRBO-2226	173	JHWS52EHLATH	114	JHWSOE42	278	JHWSDP-3-6	337	JHWSH-12A	377
JHWRBO-2428	173	JHWS-52EHRKA	272	JHWSOE44	278	JHWSDP36TH	121	JHWSH-130	274
JHWRBO-2630	173	JHWS-52LAB	272	JHWSOE46	278	JHWSDP-4-6	337	JHWSH-130B	274
JHWRBO-810	173	JHWS-52LARK	272	JHWSOE48	278	JHWSDP46TH	121	JHWSH-131BF	274
JHWRC-25	54	JHWS-53A	272	JHWSOE50	278	JHWSDR-22	337	JHWSH-16A	377
JHWRC-25-15P	54	JHWS-70	274	JHWSOE52	278	JHWSDR-22-TH	120	JHWSH-2A	377
JHWRC-37	54	JHWSA-10A	286	JHWSOE54	278	JHWSDR-24	337	JHWSH-4A	377
JHWRC-37-15P	54	JHWSA-10A-3P	288	JHWSOE56	278	JHWSDR-24-TH	120	JHWSH-6A	377
JHWRC-50	54	JHWSA-10A-3S	288	JHWSOE58	278	JHWSDR-26	337	JHWSH-8A	377
JHWRC-50-15P	54	JHWSA-10LA	286	JHWSOE60	278	JHWSDR-26-TH	120	JHWSHF-10A	377
JHWRC-75	54	JHWSA-12A	286	JHWSOE64	278	JHWSDR-28	337	JHWSHF-10LA	377
JHWRFW-12	174	JHWSA-12A-4P	288	JHWSOE68	278	JHWSDR-28-TH	120	JHWSHF-12A	377
JHWRFW-14	174	JHWSA-12A-4S	288	JHWSOE72	278	JHWSDR-30	337	JHWSHF-12SA	377
JHWRFW-16	174	JHWSA-12LA	286	JHWSOE76	278	JHWSDR-30-TH	120	JHWSHF-16A	377
JHWRFW-18	174	JHWSA-16A	286	JHWSOE78	278	JHWSDS-33	337	JHWSHF-16LA	377
JHWRFW-20	174	JHWSA-16LA	286	JHWSOE80	278	JHWSDS-62	337	JHWSHF-20A	377
JHWRFW-22	174	JHWSA-18A	286	JHWS-1216	280	JHWSDS-62-TH	120	JHWSHF-2A	377
JHWRFW-24	174	JHWSA-18LA	286	JHWS-1218	280	JHWSFH1808AW	182	JHWSHF-3A	377
JHWRFW-26	174	JHWSA-20A	286	JHWS-1220	280	JHWSFH1808BW	182	JHWSHF-4A	377
JHWRFW-28	174	JHWSA-20LA	286	JHWS-1222	280	JHWSFH1808CW	182	JHWSHF-4SA	377
JHWRFW-30	174	JHWSA-8A	286	JHWS-1224	280	JHWSFH-1808W	182	JHWSHF-6A	377
JHWRFW-32	174	JHWSA-8LA	286	JHWS-1225	280	JHWSFH1809AW	182	JHWSHF-8A	377
JHWS-102P	274	JHWSB-30	289	JHWS-1226	280	JHWSFH1809BW	182	JHWSHF-8SA	377
JHWS-102P-TH	115	JHWSB-40	289	JHWS-1228	280	JHWSFH-1809W	182	JHWSHHF-14A	377
JHWS-10A	273	JHWSB-40AA	273	JHWS-1230	280	JHWSFH1810AW	182	JHWSHHF-16A	377
JHWS-110P	274	JHWSB-526	289	JHWS-1232	280	JHWSFH1810BW	182	JHWSHHF-32A	377
JHWS-110P-TH	115	JHWSB-52EHA	272	JHWS-1234	280	JHWSFH-1810W	182	JHWSHHW-14A	377
JHWS-1120NRC	158	JHWSB52EHATH	114	JHWS-1236	280	JHWSFH1811AW	182	JHWSHHW-32A	377
JHWS-1121NRC	158	JHWSB-52EHLA	272	JHWS-616	281	JHWSFH-1811W	182	JHWSHSFDB40H	377
JHWS-1122NRC	158	JHWSC116THTB	10	JHWS-618	281	JHWSFH1812AW	182	JHWSHSFDB40M	377
JHWS-115P	274	JHWSC225THTB	9	JHWS-620	281	JHWSFH1812BW	182	JHWSHSFDB40N	377
JHWS-115P-TH	115	JHWSC409THTB	8	JHWS-622	281	JHWSFH-1812W	182	JHWSHSFDB40S	377
JHWS-121P	274	JHWSCF36	279	JHWS-624	281	JHWSFH1813AW	182	JHWSHSFDB40T	377
JHWS-121P-TH	115	JHWSCF38	279	JHWS-626	281	JHWSFH-1813W	182	JHWSHSFDB8	377
JHWS-140A	274	JHWSCF40	279	JHWS-628	281	JHWSFH1814AW	182	JHWSMD-1213	284
JHWS-140A-TH	115	JHWSCF42	279	JHWS-630	281	JHWSFH1814BW	182	JHWSMD-1214	284
JHWS-15A	273	JHWSCF44	279	JHWS-632	281	JHWSFH-1814W	182	JHWSMD-1215	284
JHWS-202P	275	JHWSCF46	279	JHWS-634	281	JHWSFH1815AW	182	JHWSMD-1216	284
JHWS-205P	275	JHWSCF48	279	JHWS-636	281	JHWSFH-1815W	182	JHWSMD-1217	284
JHWS-20A	273	JHWSCF50	279	JHWSDE-4	337	JHWSFH1816AW	182	JHWSMD-1218	284

Product Code	Page #	Product Code	Page #	Product Code	Page #	Product Code	Page #	Product Code	Page #
JHWSMD-1219	284	JHWSPRS-6P	334	JHWST-1248	276	JHWSTM-1221	282	JHWTS38394	248
JHWSMD-1221	284	JHWSPRS-6T	334	JHWST-612	277	JHWSTM-1222	282	JHWTS38437	248
JHWSMD-1222	284	JHWSPRS-8CKP	332	JHWST-614	277	JHWSTM-1223	282	JHWTS38472	248
JHWSMD-1224	284	JHWSPR-T-10-3	340	JHWST-616	277	JHWSTM-1224	282	JHWTS38500	248
JHWSMD-1227	284	JHWSPR-T-15-4	340	JHWST-618	277	JHWSTM-1225	282	JHWTS38512	248
JHWSMD-1230	284	JHWSPR-T-20-4	340	JHWST-619	277	JHWSTM-1226	282	JHWTS38551	248
JHWSPR-0-14-5	336	JHWSPR-T-25-5	340	JHWST-620	277	JHWSTM-1227	282	JHWTS38562	248
JHWSPR-C-14-1	338	JHWSPR-T-27-5	340	JHWST-622	277	JHWSTM-1228	282	JHWTS38591	248
JHWSPR-C-14-6	338	JHWSPR-T-30-6	340	JHWST-624	277	JHWSTM-1229	282	JHWTS38625	248
JHWSPR-C-18-3	338	JHWSPR-T-40-5	340	JHWST-625	277	JHWSTM-1230	282	JHWTS38669	248
JHWSPR-C-18-4	338	JHWSPR-T-45-5	340	JHWST-626	277	JHWSTM-1232	282	JHWTS38687	248
JHWSPR-C-18-8	338	JHWSPR-T-6-3	340	JHWST-628	277	JHWSTM-1234	282	JHWTS38750	248
JHWSPR-C-32-3	338	JHWSPR-T-7-3	340	JHWST-630	277	JHWSTM-1236	282	JHWTS50100	286
JHWSPR-C-36-1	338	JHWSPR-T-8-3	340	JHWST-632	277	JHWTB-101	54	JHWTS50750	286
JHWSPR-C-36-10	338	JHWSPR-T-9-3	340	JHWST-634	277	JHWTB-102	54	JHWTS50812	286
JHWSPR-C-36-4	338	JHWSPR-X-10-3	340	JHWST636	277	JHWTB103	54	JHWTS50875	286
JHWSPR-C-36-6	338	JHWSPR-X-15-4	340	JHWST-640	277	JHWTB-104	54	JHWTS50937	286
JHWSPR-C-52-4	338	JHWSPR-X-20-4	340	JHWST-812	280	JHWTB-12	54	JHWTS51551	286
JHWSPR-C-52-6	338	JHWSPR-X-25-5	340	JHWST-812-TH	116	JHWTB-35	54	JHWTS51591	286
JHWSPR-C-94-3	338	JHWSPR-X-27-5	340	JHWST-814	280	JHWTB-49	54	JHWTS51625	286
JHWSPR-C-94-5	338	JHWSPR-X-30-6	340	JHWST-814-TH	116	JHWTB-6119B	52	JHWTS51669	286
JHWSPR-K-14-4	338	JHWSPR-X-40-6	340	JHWST-816	280	JHWTB-6123B	52	JHWTS51709	286
JHWSPR-K-14-5	338	JHWSPR-Z-0-3	339	JHWST-816-TH	116	JHWTB-6124B	52	JHWTS51750	286
JHWSPR-K-14-6	338	JHWSPR-Z-1-3	339	JHWST-818	280	JHWTB-6218B	52	JHWTS51827	286
JHWSPR-K-36-4	338	JHWSPR-Z-2-4	339	JHWST-818-TH	116	JHWTM-1000	74	JHWTSCS3813	248
JHWSPR-K-36-6	338	JHWSPR-Z-3-6	339	JHWST-820	280	JHWTM-1500	74	JHWTSFS3807	248
JHWSPR-K-36-9	338	JHWSXSXL618	290	JHWST-820-TH	116	JHWTM16X1	486	JHWTSFS5005	286
JHWSPR-K-38-12	338	JHWSXSXMD418	292	JHWST-822	280	JHWTM16X1-TH	136	JHWTSMS3809	248
JHWSPR-K-38-8	338	JHWSXSXMD616	292	JHWST-822-TH	116	JHWTM-2000	74	JHWTSMS5107	286
JHWSPR-K-56-6	338	JHWSXSXMD618	292	JHWST-824	280	JHWTM-2500	74	JHWW26RC7	49
JHWSPR-K-56-7	338	JHWSXSXTL618	290	JHWST-824-TH	116	JHWTM25X1	486	JHWW26RC7B	49
JHWSPR-K-72-4	338	JHWST-1212	276	JHWST-826	280	JHWTM25X1-TH	136	JHWW26RC7BL	49
JHWSPR-K-72-6	338	JHWST1214	276	JHWST-826-TH	116	JHWTM-290	74	JHWW26TC4	49
JHWSPR-N-5-6	341	JHWST-1216	276	JHWST-828	280	JHWTM-391	74	JHWW26TC4B	49
JHWSPR-N-6-6	341	JHWST-1218	276	JHWST-828-TH	116	JHWTM-391RSD	75	JHWW26TC4BL	49
JHWSPR-N-7-6	341	JHWST-1219	276	JHWST-830	280	JHWTM-392	74	JHWW40RC7	48
JHWSPR-N-8-6	341	JHWST-1220	276	JHWST-830-TH	116	JHWTM-392RSD	75	JHWW40RC7B	48
JHWSPR-N-9-6	341	JHWST-1221	276	JHWST-832	280	JHWTM-393	74	JHWW40RC7BL	48
JHWSPR-P-0-3	339	JHWST-1222	276	JHWST-832-TH	116	JHWTM-393RSD	75	JHWW40TC4	48
JHWSPR-P-1-1	339	JHWST-1224	276	JHWST-834	280	JHWTM-394	75	JHWW40TC4B	48
JHWSPR-P-1-3	339	JHWST-1225	276	JHWST-836	280	JHWTM-394RSD	75	JHWW40TC4BL	48
JHWSPR-P-1-8	339	JHWST-1226	276	JHWST-840	280	JHWTM-395	75	JHWW55RC11	46
JHWSPR-P-2-1	339	JHWST-1228	276	JHWSTM-1210	282	JHWTM-395RSD	75	JHWW55RC11B	46
JHWSPR-P-2-4	339	JHWST-1230	276	JHWSTM-1211	282	JHWTM-492	75	JHWW55RC11BL	46
JHWSPR-P-2-6	339	JHWST-1231	276	JHWSTM-1212	282	JHWTM-493	75	JHWW55RC5BS	47
JHWSPR-P-2-8	339	JHWST-1232	276	JHWSTM-1213	282	JHWTM-750LW	74	JHWW55TC10	46
JHWSPR-P-3-6	339	JHWST-1234	276	JHWSTM-1214	282	JHWTMAXS45E2	212	JHWW55TC10B	46
JHWSPR-R-1-4	341	JHWST-1236	276	JHWSTM-1215	282	JHWTMAXS5E2	212	JHWW55TC10BL	46
JHWSPR-R-2-5	341	JHWST-1238	276	JHWSTM-1216	282	JHWTMAXS6E2	212	JHWWBSC2460C	50
JHWSPR-R-3-6	341	JHWST-1240	276	JHWSTM-1217	282	JHWTMNT	30	JHWWBSC2460S	50
JHWSPRS-12CKPT	332	JHWST-1242	276	JHWSTM-1218	282	JHWTMNTTB	30	JHWWG2408TH	121
JHWSPRS-4C	333	JHWST-1244	276	JHWSTM-1219	282	JHWTOTEBAGB	53	JHWWG2408TH	121
JHWSPRS-6CK	333	JHWST-1246	276	JHWSTM-1220	282	JHWTS38375	248	JHWWG-3	494

Product Code	Page #	Product Code	Page #	Product Code	Page #	Product Code	Page #	Product Code	Page #
JHWWG-5	494	JHWWWS-3510	168	JHWWWSBSP-8RC	250	JHWWSS-30F	261	JHWX-1284	319
JHWWG-6	494	JHWWWS-4-11RC	294	JHWWWSC116TH	10	JHWWSS-30FTB	261	JHWX-1288	319
JHWWG6412TH	121	JHWWWS-4-14	294	JHWWWSC225TH	9	JHWWSS-38F	261	JHWX-1294	319
JHWWG6412TH	121	JHWWWS-4-19RC	294	JHWWWSC-27-TH	12	JHWWSS-38FTB	261	JHWX-1296	319
JHWWRS-1	335	JHWWWS-44	188	JHWWWSC409TH	8	JHWWSS-3XT	274	JHWX-20	318
JHWWRST1	335	JHWWWS-45	187	JHWWWSC-72-TH	11	JHWWSS-57F	260	JHWX-20B	318
JHWWRST4	335	JHWWWS-45-TH	108	JHWWWSH-13	303	JHWWSS-57TB	260	JHWX-20C	318
JHWWRST8	335	JHWWWS-46	187	JHWWWSH-13TB	303	JHWWSS-810RC	277	JHWX-41C	318
JHWWWS-1108SP	164	JHWWWS-46-TH	108	JHWWWSH-16RC	306	JHWWSS-814RC	280	JHWX-41CB	318
JHWWWS-1113CA	164	JHWWWS-474	185	JHWWWSH-16TB	306	JHWWSS-8HRC	237	JHWX-41C-TH	119
JHWWWS1142PCA	164	JHWWWS-476	185	JHWWWSH-22	302	JHWWSS-SC11	144	JHWX-51B	317
JHWWWS-1164RC	156	JHWWWS-4-7RC	294	JHWWWSH-22TB	302	JHWWSSCF-15	279	JHWX-51B-TH	119
JHWWWS-1168RC	156	JHWWWS-483	185	JHWWWSH-26RC	306	JHWWSSCF-7	279	JHWX-52	318
JHWWWS1168RCF	161	JHWWWS4RWA	157	JHWWWSH-29	302	JHWWSSCOE-7	278	JHWX-52A1	318
JHWWWS1168RCS	160	JHWWWS-5	173	JHWWWSH-29TB	302	JHWWSSD11HRC	281	JHWX-52EHRK	317
JHWWWS1170BSC	147	JHWWWS-6-10HA	310	JHWWWSH-43	301	JHWWSSD-11RC	280	JHWX-52H36	318
JHWWWS1170RCU	155	JHWWWS-6-14HA	310	JHWWWSH-43TB	301	JHWWSSS-6LRC	287	JHWXFN-0810	174
JHWWWS1170RS	154	JHWWWS-6-18TB	310	JHWWWSHD11HRC	307	JHWWSSS-6RC	286	JHWXFN0810TH	102
JHWWWS1170RSC	150	JHWWWS-7-19TB	320	JHWWWSHKT-10	186	JHWWSSSP-4RC	288	JHWXFN-1214	174
JHWWWS1170RSS	155	JHWWWS-7707	169	JHWWWSM-11TRC	210	JHWWSSX-17	319	JHWXFN1214TH	102
JHWWWS1170SCA	143	JHWWWS-8707	171	JHWWWSM-13F	195	JHWWSSX-20	317	JHWXFN-1618	174
JHWWWS1170YSC	151	JHWWWSB-10HRC	237	JHWWWSM-13FTB	195	JHWWSSX-20TB	317	JHWXFN1618TH	102
JHWWWS1171BSC	147	JHWWWSB-10RC	236	JHWWWSM-15HF	195	JHWWSSX-21	316	JHWXFN-2022	174
JHWWWS1171RSC	150	JHWWWSB-12HF	217	JHWWWSM15HFTB	195	JHWWSSX-21TB	316	JHWXFN2022TH	102
JHWWWS1171SCA	143	JHWWWSB12HFTB	217	JHWWWSM-19HF	194	JHWWSSX-28	316	JHWXFN-2432	174
JHWWWS1171YSC	151	JHWWWSB-13HRC	237	JHWWWSM19HFTB	194	JHWWSSX-28TB	316	JHWXFN2432TH	102
JHWWWS1172BSC	147	JHWWWSB-13RC	236	JHWWWSM-20RC	207	JHWWTC-11	359	JHWXFN-2836	174
JHWWWS1172RSC	150	JHWWWSB-15F	216	JHWWWSM-22F	194	JHWWTC-11-TH	124	JHWXFN2836TH	102
JHWWWS1172SCA	143	JHWWWSB-15FTB	216	JHWWWSM-22FTB	194	JHWWTHSCAFL	90	KB18-01	499
JHWWWS1172YSC	151	JHWWWSB-23F	216	JHWWWSM-26HF	193	JHWWTHSCAFM	90	KBSK-01	499
JHWWWS1174BTA	147	JHWWWSB-23FTB	216	JHWWWSM26HFTB	193	JHWWTHSCAFL	90	KBTU-01	499
JHWWWS-1174TA	143	JHWWWSB-23HF	215	JHWWWSM-38HF	193	JHWX-110	318	KE18-01	499
JHWWWS-1175	143	JHWWWSB23HFTB	215	JHWWWSM38HFTB	193	JHWX-115	318	KERU-01	499
JHWWWS-1176	143	JHWWWSB-28F	215	JHWWWSM-4TRC	212	JHWX-12100	319	KG09-01	499
JHWWWS1180RS	154	JHWWWSB-28FTB	215	JHWWWSM-7HBA	211	JHWX-1234	319	KLE5417T	121
JHWWWS1190BSC	147	JHWWWSB-32F	214	JHWWWSM-7RC	206	JHWX-1236	319	KLE5417T	121
JHWWWS1190SCA	143	JHWWWSB-32FTB	214	JHWWWSM-29F	217	JHWX-1240	319	KSBG0910D	499
JHWWWS-1191SC	143	JHWWWSB-56F	213	JHWWWSM29FTB	217	JHWX-1242	319	KSBG18-10DISP	499
JHWWWS-12	172	JHWWWSB-56FTB	213	JHWWWSMD10HRC	208	JHWX-1244	319	KWTBM	13
JHWWWS-12-12	255	JHWWWSB-5XT	234	JHWWWSMD-6RC	207	JHWX-1246	319	KWTELECWKT	15
JHWWWS-12-8	255	JHWWWSB-6ADPA	253	JHWWWS-MID10	152	JHWX-1248	319	KWTELEKITL	15
JHWWWS-14	174	JHWWWSB-7A	249	JHWWWSMS-9LRC	211	JHWX-1252	319	KWTELEKITM	15
JHWWWS-14-11	296	JHWWWSB-7U	238	JHWWWS-14HRC	277	JHWX-1254	319	KWTELEKITXL	15
JHWWWS1414RC	296	JHWWWSB-7RC	249	JHWWWS-15F	263	JHWX-1256	319	KWTHRSGRH	13
JHWWWS-1419RC	296	JHWWWSBCF-8	239	JHWWWS-15FTB	263	JHWX-1258	319	KWTIWWKIT	13
JHWWWS-14-TH	102	JHWWWSBCO-10	240	JHWWWS-15RC	276	JHWX-1260	319	KWTPFBOX	14
JHWWWS-1605	163	JHWWWSBCOM-10	240	JHWWWS-18HF	263	JHWX-1264	319	KWTPFFOR	14
JHWWWS-16-7H	312	JHWWWSBD-13RC	242	JHWWWS18HFTB	263	JHWX-1268	319	KWTPFIND	14
JHWWWS-16-8H	312	JHWWWSBD-7RC	238	JHWWWS-19F	262	JHWX-1270	319	LAP-KNIFE	428
JHWWWS-1705A	162	JHWWWSBD-9RC	242	JHWWWS-19FTB	262	JHWX-1272	319	LTS-100-E	487
JHWWWS-1710A	162	JHWWWSBHMD-7	253	JHWWWS-22F	262	JHWX-1276	319	LTS-30-E	487
JHWWWS-2-13	254	JHWWWSBS-10RC	249	JHWWWS-22FTB	262	JHWX-1280	319	LTS-50-E	487
JHWWWS-2-8	254	JHWWWSBS-7LRC	250	JHWWWS-23RC	276	JHWX-1282	319	MOIE3-16C-TH	127

Product Code	Page #	Product Code	Page #	Product Code	Page #	Product Code	Page #	Product Code	Page #
NP-12-COM	433	PYT1500132	95	QJO8A	68	QJRXSM8A	73	QJXM22A	71
NP-12-TEN	431	PYT1500139	97	QJO9A	68	QJRXSM9A	73	QJXM23A	71
NP-12-VEN	432	PYT1500140	97	QJOM10A	69	QJSD12A	68	QJXM24A	71
NP-16-U7/8-HP	429	QCB-1250	484	QJOM11A	69	QJSD16A	68	QJXM25A	71
NP-19-U7/8-HP	429	QCB-150	484	QJOM12A	69	QJSD8A	68	QJXM26A	71
NP-22-U7/8-HP	429	QCB-300	484	QJOM13A	69	QJX10A	70	QJXM27A	71
P-HB	487	QCB-450	484	QJOM14A	69	QJX12A	70	QJXM6A	71
PB13-0.5-10/14-1140-5P	441	QCB-600	484	QJOM15A	69	QJX14A	70	QJXM7A	71
PB13-0.5-14/18-1140-5P	441	QCB-900	484	QJOM16A	69	QJX16A	70	QJXM8A	71
PB13-0.5-R-10-1140-5P	441	QCG-150	484	QJOM17A	69	QJX18A	70	QJXM9A	71
PB13-0.5-R-14-1140-5P	441	QCG-300	484	QJOM18A	69	QJX20A	70	QJ-Y	73
PB13-0.5-R-18-1140-5P	441	QJBOER12A	71	QJOM19A	69	QJX22A	70	QS-L-10PK	138
PB13-0.5-R-24-1140-5P	441	QJBOER16A	71	QJOM20A	69	QJX24A	70	QS-M-10PK	138
PB57A	58	QJBOER18A	71	QJOM21A	69	QJX26A	70	QS-P-10PK	138
PC-10-DTF	431	QJBOER20A	71	QJOM22A	69	QJX28A	70	QSPCOIL-10PK	138
PC-10-DTR	431	QJBOERM16A	71	QJOM23A	69	QJX30A	70	QS-PM-10PK	138
PC-11-19-PS	428	QJBOERM18A	71	QJOM24A	69	QJX32A	70	QSPMCOIL10PK	138
PC-12-14-PS	428	QJD12A-80	68	QJOM25A	69	QJX34A	70	QS-S-10PK	138
PC-12-COM	433	QJD16A	68	QJOM26A	69	QJX8A	70	QS-XL-10PK	138
PC-12-TEN	431	QJD8A-72	68	QJOM27A	69	QJX9A	70	QWHDBLU110PK	138
PC-12-VEN	432	QJO10A	68	QJOM6A	69	QJXB16A	72	QWHDBLU1CASE	138
PC-15-GNP	430	QJO12A	68	QJOM7A	69	QJXB18A	72	QWHDYLW110PK	138
PC-15-TBX	428	QJO14A	68	QJOM8A	69	QJXB20A	72	QXD16A	68
PC-16-DECO	434	QJO16A	68	QJOM9A	69	QJXB22A	72	QXD24A	68
PC-19-GT7	429	QJO18A	68	QJRX18A	72	QJXB24A	72	QXD32A	68
PC-20-LAM	434	QJO20A	68	QJRX20A	72	QJXBM11A	72	QXO24A	68
PC-22-FILE-U7	429	QJO22A	68	QJRX22A	72	QJXBM12A	72	QXO26A	68
PC-22-GT7	429	QJO22ARTH60	69	QJRX24A	72	QJXBM13A	72	QXO28A	68
PC-22-INS	434	QJO24A	68	QJRX26A	72	QJXBM14A	72	QXO30A	68
PC-24-PLS	435	QJO26A	68	QJRX28A	72	QJXBM16A	72	QXO32A	68
PC-24-TIM	434	QJO28A	68	QJRX30A	72	QJXBM18A	72	QXO34A	68
PC-6-DRY	433	QJO30A	68	QJRX32A	72	QJXBM19A	72	QXO36A	68
PC-9-9/17-PS	428	QJO32A	68	QJRX34A	72	QJXD12A	70	QXO38A	68
PCH-INSPECT	95	QJO32ARTH	69	QJRXS10A	73	QJXD14A	70	QXO40A	68
PCH-PARTS-CB	95	QJO34A	68	QJRXS12A	73	QJXD16A	70	QXO42A	68
PCH-PARTS-CC	95	QJO34ARTH	69	QJRXS14A	73	QJXD18A	70	QXO44A	68
PCH-PARTS-CO	95	QJO36A	68	QJRXS16A	73	QJXD22A	70	QXO46A	68
PCH-PARTS-VY	95	QJO36ARTH	69	QJRXS18A	73	QJXD24A	70	QXO48A	68
PCHPARTSXDCB	95	QJO38ARTH	69	QJRXS22A	73	QJXD28A	70	QXO50A	68
PCH-TOOL	95	QJO40A	68	QJRXS24A	73	QJXD30A	70	QXO52A	68
PCH-TOOLRET	95	QJO40ARTH	69	QJRXS30A	73	QJXD32A	70	QXO54A	68
PCH-TOOLTRIG	95	QJO44A	68	QJRXS8A	73	QJXM10A	71	QXO56A	68
PCH-TOOLXD	95	QJO44ARTH	69	QJRXSM10A	73	QJXM11A	71	QXO58A	68
PCH-TOOLXDRE	95	QJO48A	68	QJRXSM11A	73	QJXM12A	71	QXO60A	68
PCH-TOOLXDTR	95	QJO48ARTH	69	QJRXSM12A	73	QJXM13A	71	QXO64A	68
PH-6604-1P	477	QJO50ARTH	69	QJRXSM13A	73	QJXM14A	71	QXOM17A	69
PH-6604-25	477	QJO52A	68	QJRXSM14A	73	QJXM15A	71	QXOM18A	69
PYT1500019	138	QJO52ARTH	69	QJRXSM15A	73	QJXM16A	71	QXOM19A	69
PYT1500089	94	QJO56ARTH	69	QJRXSM16A	73	QJXM17A	71	QXOM20A	69
PYT1500090	94	QJO60ARTH	69	QJRXSM17A	73	QJXM18A	71	QXOM21A	69
PYT1500100	94	QJO64ARTH	69	QJRXSM18A	73	QJXM19A	71	QXOM22A	69
PYT1500113	96	QJO66ARTH	69	QJRXSM19A	73	QJXM20A	71	QXOM23A	69
PYT1500114	96	QJO86ARTH	69	QJRXSM20A	73	QJXM21A	71	QXOM24A	69

Product Code	Page #	Product Code	Page #	Product Code	Page #	Product Code	Page #	Product Code	Page #
QXOM25A	69	QXY	73	QYOM34A	69	QYX48A	70	QZO42ADP	68
QXOM26A	69	QYBOER20A	71	QYOM36A	69	QYX50A	70	QZO44A	68
QXOM27A	69	QYBOER22A	71	QYRX18A	72	QYX52A	70	QZO44ADP	68
QXOM29A	69	QYBOER24A	71	QYRX20A	72	QYXB20A	72	QZO46A	68
QXOM30A	69	QYBOERM18A	71	QYRX22A	72	QYXB24A	72	QZO46ADP	68
QXOM32A	69	QYBOERM24A	71	QYRX24A	72	QYXB28A	72	QZO48A	68
QXOM34A	69	QYD12A-80	68	QYRX26A	72	QYXB30A	72	QZO48ADP	68
QXOM36A	69	QYD16A	68	QYRX28A	72	QYXB32A	72	QZO50A	68
QXOM41A	69	QYO18A	68	QYRX30A	72	QYXB36A	72	QZO50ADP	68
QXSD16A	68	QYO20A	68	QYRX32A	72	QYXB18A	72	QZO52A	68
QXSD24A	68	QYO22A	68	QYRX34A	72	QYXB24A	72	QZO52ADP	68
QXSD32A	68	QYO24A	68	QYRX36A	72	QYXB28A	72	QZO54A	68
QXX20A	70	QYO26A	68	QYRX38A	72	QYXD20A	70	QZO54ADP	68
QXX22A	70	QYO28A	68	QYRX40A	72	QYXD22A	70	QZO56A	68
QXX24A	70	QYO30A	68	QYRX44A	72	QYXD24A	70	QZO56ADP	68
QXX26A	70	QYO32A	68	QYRX48A	72	QYXD28A	70	QZO58ADP	68
QXX28A	70	QYO34A	68	QYRX52A	72	QYXD30A	70	QZO60A	68
QXX30A	70	QYO36A	68	QYRXS18A	73	QYXM13A	71	QZO60ADP	68
QXX32A	70	QYO38A	68	QYRXS20A	73	QYXM14A	71	QZO64A	68
QXX34A	70	QYO40A	68	QYRXS22A	73	QYXM15A	71	QZO64ADP	68
QXX36A	70	QYO42A	68	QYRXS24A	73	QYXM16A	71	QZO66A	68
QXX38A	70	QYO44A	68	QYRXS26A	73	QYXM17A	71	QZO66ADP	68
QXX40A	70	QYO46A	68	QYRXS28A	73	QYXM18A	71	QZO68A	68
QXX42A	70	QYO48A	68	QYRXS30A	73	QYXM19A	71	QZO68ADP	68
QXX44A	70	QYO50A	68	QYRXS32A	73	QYXM20A	71	QZO72A	68
QXX46A	70	QYO52A	68	QYRXS36A	73	QYXM21A	71	QZO72ADP	68
QXX48A	70	QYO52ARTH	69	QYRXSM15A	73	QYXM22A	71	QZO76ADP	68
QXX50A	70	QYO56A	68	QYRXSM16A	73	QYXM23A	71	QZO80A	68
QXX52A	70	QYO56ARTH	69	QYRXSM17A	73	QYXM24A	71	QZO80ADP	68
QXX54A	70	QYO60A	68	QYRXSM18A	73	QYXM25A	71	QZO88A	68
QXX56A	70	QYO60ARTH	69	QYRXSM19A	73	QYXM26A	71	QZO96A	68
QXX58A	70	QYO64ARTH	69	QYRXSM20A	73	QYXM27A	71	QZOM24A	69
QXX60A	70	QYO68ARTH	69	QYRXSM21A	73	QYXM29A	71	QZOM24ADP	69
QXX64A	70	QYO72	68	QYSBX18A	72	QYXM30A	71	QZOM27A	69
QXXB44A	72	QYO72ARTH	69	QYSBX24A	72	QYXM32A	71	QZOM27ADP	69
QXXB48A	72	QYO80	68	QYSD12A	68	QYXM34A	71	QZOM30A	69
QXXM16A	71	QYOM14A	69	QYSD16A	68	QYXM36A	71	QZOM30ADP	69
QXXM17A	71	QYOM15A	69	QY-X	73	QZD24B	68	QZOM32A	69
QXXM18A	71	QYOM16A	69	QYX16A	70	QZD24BDP	68	QZOM32ADP	69
QXXM19A	71	QYOM17A	69	QYX18A	70	QZD32A-1	73	QZOM34ADP	69
QXXM20A	71	QYOM18A	69	QYX20A	70	QZD32B	68	QZOM36A	69
QXXM21A	71	QYOM19A	69	QYX22A	70	QZD32BDP	68	QZOM36ADP	69
QXXM22A	71	QYOM20A	69	QYX24A	70	QZO32A	68	QZOM38ADP	69
QXXM23A	71	QYOM21A	69	QYX26A	70	QZO32ADP	68	QZOM41ADP	69
QXXM24A	71	QYOM22A	69	QYX28A	70	QZO34A	68	QZOM46ADP	69
QXXM25A	71	QYOM23A	69	QYX30A	70	QZO34ADP	68	QZOM50A	69
QXXM26A	71	QYOM24A	69	QYX32A	70	QZO36A	68	QZOM50ADP	69
QXXM27A	71	QYOM25A	69	QYX34A	70	QZO36ADP	68	QZOM55A	69
QXXM29A	71	QYOM26A	69	QYX36A	70	QZO38A	68	QZOM55ADP	69
QXXM30A	71	QYOM27A	69	QYX38A	70	QZO38ADP	68	QZOM60ADP	69
QXXM32A	71	QYOM29A	69	QYX40A	70	QZO40A	68	QZOM65ADP	69
QXXM34A	71	QYOM30A	69	QYX42A	70	QZO40ADP	68	QZOM70ADP	69
QXXM36A	71	QYOM32A	69	QYX46A	70	QZO42A	68	QZSD24A	68

Product Code	Page #	Product Code	Page #	Product Code	Page #	Product Code	Page #
QZSD24ADP	68	QZXM32ADP	71	RTWH64Y	73	THL1A	91
QZSD32A	68	QZXM34A	71	RTWH72Y	73	THL2A	91
QZ-X	73	QZXM34ADP	71	RTWH80Y	73	THPRTA	108
QZX26ADP	70	QZXM36A	71	RTWH88Y	73	THRET1CLIPSA	92
QZX30A	70	QZXM36ADP	71	RTWH96X	73	THRET2CLIPSA	92
QZX34A	70	QZXM41ADP	71	RTWHM16J	73	THUNI24A	91
QZX34ADP	70	QZXM46ADP	71	S-60E	274	THUNI5CLIPSA	92
QZX36A	70	QZXM50ADP	71	SB-3732-2.5-125	504	THUNIRET1A	92
QZX36ADP	70	QZXM55ADP	71	SC127V	515	THUNIRET2A	92
QZX38ADP	70	QZXM60ADP	71	SC150	487	THUNIRET3.5	92
QZX40A	70	R31000	367	SC150NGV	515	THWS1A	93
QZX40ADP	70	R31000-TH	126	SC300	487	THWSNC	93
QZX42A	70	R31005	367	SC400	487	THWSRET1A	92
QZX42ADP	70	R31005-TH	126	SE-15-24	436	THWSRET1A	93
QZX44A	70	R31010	367	SE-15-30	436	THYA728A	136
QZX46A	70	R31010-TH	126	SE-16-21	436	TLA28NMW	62
QZX46ADP	70	R31015	367	SHF-10A-TH	128	TLPT4NMW	62
QZX48A	70	R31015-TH	126	SHF-10LA-TH	128	TLPT5NMW	62
QZX48ADP	70	R31020	367	SHF-12A-TH	128	TLPT6NMW	62
QZX50A	70	R31020-TH	126	SHF-12SA-TH	128	USBATOMINIB	58
QZX50ADP	70	R31025	367	SHF-16A-TH	128	VR1ATTMD10PK	137
QZX52A	70	R31025-TH	126	SHF-4A-TH	128	VR2ATTMD10PK	137
QZX52ADP	70	R31030	367	SHF-4SA-TH	128	VRATTHMD10PK	137
QZX54A	70	R31030-TH	126	SHF-6A-TH	128	W40X50PV	48
QZX54ADP	70	R31035	367	SHF-8A-TH	128	WB-ADJ-10PK	93
QZX56A	70	R31035-TH	126	SHF-8SA-TH	128	WBADJCRD10PK	93
QZX56ADP	70	R31040	367	SQZ150003	500	WBADJRET10PK	93
QZX58A	70	R31040-TH	126	SQZ150003-HSBL	500	WBB400	497
QZX58ADP	70	R31090	366	SQZ150003-SBL	500	WBB500	497
QZX60A	70	R31090-TH	126	SR1000-E	487	WBB600	497
QZX60ADP	70	R31095	366	SR150-E	487	WBB700	497
QZX64A	70	R31095-TH	126	SR200-E	487	WB-L	93
QZX64ADP	70	R31100	366	SR300-E	487	WB-L-10PK	93
QZX66A	70	R31100-TH	126	SR600-E	487	WB-M-10PK	93
QZX66ADP	70	R31105	366	SUP-20-LAM	429	WBP300	497
QZX68A	70	R31105-TH	126	SWR-24	107	WBP500	497
QZX68ADP	70	R31110-TH	126	SWR-28	107	WBP625	497
QZX70ADP	70	R31115	366	SWR-32	107	WBP710	497
QZX72A	70	R31115-TH	126	SWR-36	107	WBP900	497
QZX72ADP	70	R31120	366	SWR-40	107	WB-S	93
QZX76ADP	70	R47057	366	SWR-44	107	WB-S-10PK	93
QZX80A	70	R47057-TH	126	SWR-48	107	WB-SLIML10PK	93
QZX80ADP	70	RET-52STEEL	92	SWR-52	107	WB-SLIMM10PK	93
QZXM24A	71	RIG31045	367	SWR-56	107	WB-SLIMS10PK	93
QZXM24ADP	71	RTWH104Y	73	SWR-60	107	WSC-45-TH	12
QZXM25A	71	RTWH120Y	73	SWR-SET	107	WTC-45W	359
QZXM26A	71	RTWH36J	73	THCARA1SL	91	WTHRET1CLIPS	92
QZXM27A	71	RTWH40J	73	THCARA257FTB	121	WTHRET2CLIPS	92
QZXM27ADP	71	RTWH44J	73	THCARAA	91		
QZXM29A	71	RTWH48Y	73	THFSN25100	136		
QZXM30A	71	RTWH52J	73	THFSNE3-22SM	127		
QZXM30ADP	71	RTWH56Y	73	THHARDHAT1	93		
QZXM32A	71	RTWH60Y	73	THHARDHAT2	93		

1/4" Drive	193-212
3/8" Drive	213-259
1/2" Drive	260-301
3/4" Drive	301-315
1" Drive	316-324
1-1/2" Drive	324-326

A

Adapters, Hand	
1/4" Drive	205
3/8" Drive	234
1/2" Drive	274
3/4" Drive	305
Adapters, Impact	
3/8" Drive	253
1/2" Drive	293
3/4" Drive	309
1" Drive	319
1-1/2" Drive	324
Adjustable Wrenches	
Alligator	175
Combination / Pipe	176
Construction	178
Ergonomic Handle	176-177
Heavy Duty, Side Nut	175
Standard, Black Finish	177
Standard, Chrome Finish	177
Tools@Height Tethered	104
Valve Persuader Handle	175
Anchor Straps	91

B

Belts	96, 488
Bolt Cutters	485
Bolt Thru Sockets	
Bolt Thru Socket Set	230, 241
Bolt Thru Sockets	241
Bow Saws and Blades	436-437
Breaker Bars	
1/4" Drive	204-205
3/8" Drive	234-235
1/2" Drive	273-275
3/4" Drive	234
1" Drive	318
Brush, Wire	481
Buckets, Tools@Height	97
Budd Wheel Sockets	
3/4" Drive	309
1" Drive	320
Bulk Storage Cage	50
Burrs, Rotary	481

C

C-Clamps	
C-Clamp, Copper Screw	365
C-Clamp, Heavy Service	366
C-Clamp, Standard Screw	365
C-Clamp, Tools@Height	125
Cabinets (See Tool Storage)	
Carts, Service	50
Chain Pipe Wrench	369
Chisels	
Cape Chisels	382
Chisel Holder	381
Chisel & Punch Sets	378-381, 462
Cold Chisels	381
Diamond Point Chisels	382
Extra Long Cold Chisels	382
Mason's	462
Rivet Buster	382
Round Nose Chisels	382
Slitting	462
Tools@Height	130-133
Wood	483
Chisels, Tools@Height	130-132
Clamps	
C-Clamps	365-366
L-Clamps	485
Quick-Clamps	484
Spring Clamps	484
Clinch Nut Tools	
Combination Wrenches	98-99, 142-161
Creepers and Seats	
Adjustable Swivel Seat Creeper ..	493
Heavy-Duty Drop Shoulder	493
Mechanic's Seat Creeper	493
Cutters	
Bolt Cutters	485
Cable Cutters	358
Hose Cutters	370

D

Drag Link Sockets 1/2" Drive	289
Drive Tools, Sockets, and Sets, Tools@Height	109-119

E

Electronic Torque Wrenches	60-61
Extensions, Hand	
1/4" Drive	205-206
3/8" Drive	234-235
1/2" Drive	274-275
3/4" Drive	305
1" Drive	318

Extensions, Impact

3/8" Drive	253
1/2" Drive	293
3/4" Drive	309
1" Drive	319
1-1/2" Drive	324

Eyebolts

Plain Pattern	494
Shoulder Pattern	494

F

Feeler Gauge Sets	496
Feeler Gauge Sets, Tools@Height ..	135
Files	
Chain Saw	476-478
Engineering File Set	358
Farmer's Double Duty	472
File Cleaner	476
Filemaster	475
Flat	466
Flat Chisel Bit	471
Half Round	469
Hand	465
Handles	477-480
Homeowner's	472
Lathe	465
Mill File	465-467
Mill Saws	471
Needle	470-471
Needle File Sets	464
Plastic Cut	467
Round	469
Round Chain Saw	476
Saw	472, 474
Set	463-464
Slim Taper	473
Square	468
Taper Saw	472
Three Square	468
Tools@Height	134
Warding	466
Files, Tools@Height	134
Flange Jacks	368
Flashlight	500
Flexextensions	
3/8" Drive	252
1/2" Drive	290-292

G

Gasket Scrapers	482
Gloves	504
Grease Gun	136

H

Hacksaws

Hacksaw Frames	438-439
Hand Hacksaw Blades	440
Mini Hacksaws	439
Rodsaw Hacksaw Blades	440
Tools@Height.....	133
Tungsten Carbide Hacksaw Blade...	440

Hacksaws, Tools@Height	133
------------------------------	-----

Hammer Wrenches 6-Point	184
-------------------------------	-----

Hammers

Brass.....	127, 376
Ball Pein.....	127, 374-375
Claw	127, 375
Cross Pein	375
Dead Blow	374
Drilling	127, 375
Sledge.....	377
Soft Face.....	376-377
Soft Face Hammer Kit.....	376
Soft Face Hammer Tips.....	376-377
Tools@Height	127-128

Hammers, Tools@Height	127-128
-----------------------------	---------

Handsaws

Backsaw	431
Bowsaws & Blades	447-478
Compass Saw	433
Coping Saw	435
Dovetail	431
Drywall Saw.....	433
Folding Saw	428
General Purpose Saws	428-430
Japanese Style Pull Saws.....	428
Laminator.....	434
Laplander Folding Saw	428
Plaster.....	435
Polystyrene.....	434
Stradivarius Musical Saw	435
Timber.....	434
Toolbox Saw	428, 430
Tools@Height.....	132
Veneer Saw.....	432

Handsaws, Tools@Height	132
------------------------------	-----

Holesaw Accessories	450-451
---------------------------	---------

Holesaws

Accessories	450-451
Bi-Metal Holesaws.....	446
Carbide-Tipped Holesaws....	448-449
Holesaw Sets	445-448
Superior Holesaws.....	444-445

Holsters, Tools@Height	94
------------------------------	----

Hydraulics

Aluminum Cylinders	396
Bottle Jacks.....	416-417
Couplers.....	421
Double-Acting Cylinders	394
Fittings	420-422
Flat Body Cylinders and Kits..	397-398
Flow Control Valves	422
Gauges	420
Hollow Hole Cylinders	399
Hoses	420
Lock Nut Cylinders	395
Low Profile Cylinders	402
Manifolds	422
Maintenance Kits	419
Mini Bottle Jacks	416
Presses.....	415
Pull Cylinders.....	400
Pumps, Air.....	406-407
Pumps, Electric	408-409
Pumps, Gas	413
Pumps, Hand.....	403-404
Single Acting Cylinders....	390-393
Spreaders.....	418
Threaded Hole Cylinders.....	401
Toe Jacks.....	417

I

Impact Driver, 3/8" Drive, Hand	253
---------------------------------------	-----

Impact Socket and Sets

(See Sockets and Sets, Impact)

Inspection Mirror

Telescoping	503
Tools@Height.....	136

Insulated Tools

1/2" Drive Ratchet and Extensions.....	518
1/2" Drive Sockets	518
Adjustable Wrenches	517
Bolt Cutters	516
Cable Cutters	516
Knives.....	515
Open End Wrenches	517
Pliers	510-513
Quick Adjust Water Pump Pliers	514
Ratcheting Screwdriver Sets....	508

Scissors.....	515
Screwdrivers and Sets	508-509
Tweezers.....	515
Voltage Tester.....	517

Interchangeable Torque Heads

Adaptors	71
Box End.....	70-72
Fixed Square Drive.....	68
Flare Nut	72-73
Open End.....	68-69
Ratcheting Square Drive.....	68
Ratcheting Flare Nut	72
Ratchet Wrench.....	71

J

Job Site Boxes.....	51
---------------------	----

K

Knives, Safety.....	498, 501
Knives, Utility	499-500

L

L-Clamps	366
----------------	-----

Lanyards & Tethers.....	91-93
-------------------------	-------

Levels

Tools@Height.....	136
Torpedo.....	487

Light, Work.....	501-502
------------------	---------

Long Tape Measure	487
-------------------------	-----

M

Magnetic Pick Up Tools.....	502
-----------------------------	-----

Master Sets

Advanced Maintenance Service Set ..	27
Electrical Maintenance Service Set ...	33
General Maintenance Set.....	31
Heavy Duty Maintenance Service Set ..	32
Intermediate Technician Tool Set.....	26
Maintenance Tool Sets (General)	34
Mammoth Tool Set	16-17
Master Maintenance Tool Set ..	24-25
Maxxum Tool Set	20-21
Mega Tool Set	18-19
Mechanical Maintenance Set....	30
Monster Tool Set	22-23
Petroleum Oilfield Service Set ..	28
Oilfield Tool Set.....	29
Tools@Height Master Sets...8-15, 80-89	
Trade Sets	426-427

Master Sets, Metric

Mammoth Tool Set, Metric.....	16-17
Maxxum Tool Set, Metric.....	20-21
Mega Tool Set, Metric.....	18-19

Master Sets, Tools@Height

- Tools@Height Master
- Maintenance Tool Set 8, 80
- Tools@Height Intermediate
- Maintenance Service Set..... 9, 81
- Tools@Height General
- Maintenance Service Set..... 10, 82
- Tools@Height Basic
- Maintenance Service Set 11, 83
- Tools@Height Basic Starter Plus Set ... 12, 84
- Tools@Height Basic Starter Set 12, 84
- Tools@Height Ironworker's Toolkit 13, 85
- Tools@Height Boilermaker's Toolkit ... 13, 86
- Tools@Height High Rigging Toolkit 13, 87
- Tools@Height Pipefitter's
- Foreman's Toolkit..... 14, 88
- Tools@Height Individual
- Pipefitter's Toolkit 14, 88
- Tools@Height Pipefitter's
- Gang Box Kit..... 14, 88
- Tools@Height Electrician's Toolkit..... 15, 89
- Tools@Height Electrician's Crew Kit ... 15, 89

Mechanical Torque Testers

- Comparator..... 59
- Micrometer Adjustable Torque Wrenches

 - Comfort Grip 64
 - Interchangeable Head 66
 - Metal Handle Dual Scale..... 65

- Mirrors, Inspection 503
- Modular Industrial Storage..... 38-45
- Multipliers, Torque

 - Torque Multipliers - Plate Reaction ... 75
 - Torque Multipliers with Handles 74

- MULTITORQ, Torque Acquisition Meter. 58

N

- Nail Puller 504
- Nut Drivers 341

P

- Pick-Up Tool, Tools@Height..... 35
- Pinch Bars & Sets..... 385-386
- Pipe Tools

 - Chain Pipe Tongs 369
 - Flange Jacks 368
 - Nipple Remover & Installer Kit 370
 - Pipe Chain Wrenches 369
 - Pipe Wrenches, Aluminum .. 366-367
 - Pipe Wrenches, Cast Iron.... 366-367
 - Strap Wrench..... 368
 - Tools@Height 126
 - Tube Bender..... 369

- Tubing Cutters and Wheels 370
- Tubing Flaring Tools 369
- Pliers & Pipe Wrench..... 349
- Pipe Wrenches

 - Aluminum 366-367
 - Cast Iron..... 366-367
 - Tools@Height..... 126

Pliers

- Cable Tie Cutters..... 358
- Chain Nose..... 354
- Combination Slip-Joint..... 349
- Diagonal Cutting..... 351-352
- Duck Bill 355
- Electrical..... 355-356
- End Cutting Nippers 350
- Heavy Duty Snap Ring & Tips..... 363
- Insulated 510-514
- Lineman's Pliers 350
- Lock Ring 364
- Locking Pliers 360
- Locking Pliers, Comfort Grip 359
- Long Nose 352-354
- Needle Nose..... 352-354
- Nose Pliers 352-354
- Nut Gripping Pliers..... 349
- Sets..... 346-347
- Side Cutters..... 349-351
- Side Cutting Combination Pliers ... 349
- Slip Joint Pliers..... 349
- Snap (Retaining) Ring Pliers 361-364
- Tools@Height..... 122-124
- Universal Pliers Wrench 348
- Utility Superjoint..... 348
- Water Pump..... 348
- Wire Strippers 355
- Wire Twister..... 359

- Pliers, Tools@Height..... 122-124
- Portable Bandsaw Blades..... 441
- Pouches, Tools@Height..... 95
- Power Flexextensions

 - 3/8" Drive..... 252
 - 1/2" Drive..... 290-292

- Pre-Set Interchangeable

 - Head Torque Wrenches 66

- Pre-Set Torque Screwdrivers..... 63
- Prybars

 - Comfort Grip Handle..... 385-386
 - Lightweight Prybars 385
 - Ladyfoot 386
 - Pinch Bars..... 385
 - Roll Bars 385-386
 - Tools@Height 129

Punches

- Brass..... 384
- Center 384
- Chisel Sets 379
- Long Taper 384
- Pilot 383
- Pin..... 383
- Prick 384
- Punch and Chisel Holder..... 381
- Punch and Chisels Sets..... 378, 462
- Punch Sets 380, 462
- Solid 383
- Tools@Height..... 130-132
- Punches, Tools@Height..... 130-132
- Putty Knife..... 486

R

- Rasps..... 474-475
- Ratcheting Adjustable Wrenches 178
- Ratchets

 - 1/4" Drive Black Narrow Head..... 204
 - 1/4" Drive Chrome Flex Head 204
 - 1/4" Drive Chrome Narrow Head... 204-205
 - 3/8" Drive Black Narrow Head..... 233
 - 3/8" Drive Black Round Head 233
 - 3/8" Drive Chrome Flex Head 233
 - 3/8" Drive Chrome Narrow Head... 233
 - 3/8" Drive Chrome Round Head .. 233
 - 3/8" Drive Spinner Disk..... 234
 - 1/2" Drive Black Construction..... 273
 - 1/2" Drive Black Narrow Head..... 272
 - 1/2" Drive Black Round Head 272
 - 1/2" Drive Chrome Flex Head 272
 - 1/2" Drive Chrome Narrow Head... 272
 - 1/2" Drive Chrome Round Head .. 272
 - 1/2" Drive Chrome Round Head Lineman's 272
 - 1/2" Drive Scaffolding Ratchet 273
 - 1/2" Drive Spinner Disk..... 274
 - 3/4" Drive Black Reversible 304
 - 3/4" Drive Chrome Reversible 304
 - 1" Drive Chrome 318

- Reciprocating Sawblades

 - Carbide Tipped Saw Blades..... 460
 - Carbody Saw Blades 459
 - Demolition 457
 - Diamond Grit Blades 461
 - Fire & Rescue 457
 - Metal Cutting Blades..... 454-455
 - Pallet Cutting Blades..... 457
 - Special Cutting Blades 459
 - Wood & Metal Cutting Blades..... 456
 - Wood & Plastic Cutting Blades .. 458

Ret Rings®
 3/4" Drive 309
 1" Drive 320
 1-1/2" Drive 325

Roll Cabinets (See Tool Storage)

Rotary Burrs 481

Rulers 487

S

Safe Buckets, Tools@Height..... 97

Safety Glasses..... 486

Scrapers
 Cabinet Scrapers..... 483
 Carbide Scrapers and Blades 482
 Gasket Scrapers 482
 Tools@Height..... 133

Screw Extractors and Sets..... 496

Screwdrivers and Sets
 Sets, Bit Sets..... 342
 Sets, Combination 330-333
 Bit Holder — 1/4" Hex 336
 Cabinet Tip 334
 Cabinet Slotted 337, 338
 Insulated..... 508-509
 Nutdrivers..... 341
 Offset..... 336
 Phillips® 337, 339
 Pozidriv® 339
 Ratcheting Magnetic..... 335
 Ratcheting, Mini 336
 Robertson® Screwdrivers..... 341
 Screwdrivers, Tools@Height.. 120-121
 Keystone Slotted 337-338
 Tamper Resistant Torx..... 340
 Tools@Height..... 120-121
 Torx® 340

Screwdrivers, Tools@Height

Screwdrivers, Torque
 T-Handle Fixed 62
 Preset Drive Tools, Torqy 62
 TorqControl T-Handle Adjustable.... 62
 Torque Screwdrivers - Micro-Adjustable... 63
 Torque Screwdrivers - Single Setting.... 63

Service Carts 50

Sets, See Master Tool Sets

Set-up Wedges 494

Single Setting Torque Wrenches 66

Slugging Wrenches and Retainers 107

Snips
 Aviation Snips 357
 Bulldog Aviation Snip..... 357

Long Nose Aviation Snip 357

Multi-Purpose Snip 358

Offset Aviation Snip 357

Straight Pattern Tin Snips 358

Square 487

Sockets and Sets, Hand
 1/4" Drive Combination Socket
 and 1/4" Drive Tool Sets..... 193, 206
 1/4" Drive Ball Hex Bit 211
 1/4" Drive Deep..... 207-210
 1/4" Drive Hex Bit..... 210-212
 1/4" Drive Long Hex Bit 211
 1/4" Drive Stubby Hex Bit 212
 1/4" Drive Phillips® 212
 1/4" Drive Slotted..... 212
 1/4" Drive Shallow..... 206-210
 1/4" Drive Tools@Height.... 110-111
 1/4" Drive Torx® Bit..... 212
 3/8" Drive Combination Socket
 and Drive Tool Sets 213-230, 235
 3/8" Drive Ball Hex Bit 249, 251
 3/8" Drive Bolt Thru Socket Set... 230, 241
 3/8" Drive Bolt Thru Sockets 241
 3/8" Drive Flare Nut
 Crowfoot Wrenches 239
 3/8" Drive Deep 242-243, 246
 3/8" Drive Hex Bit 249
 3/8" Hex Driver..... 258
 3/8" Drive Long Hex Bit 251
 3/8" Drive Magnetic Hex
 Bit Holder 235
 3/8" Drive Open End
 Crowfoot Wrenches..... 240
 3/8" Drive Pentasocket..... 238
 3/8" Drive Phillips® Bit 250
 3/8" Drive Shallow..... 236-238, 244
 3/8" Drive Slotted Bit 250
 3/8" Drive Spark Plug..... 243
 3/8" Drive Tamper-Resistant
 Torx® Bit 251
 3/8" Drive Tools@Height.... 111-113
 3/8" Drive Torx® Bit 251
 3/8" Drive Turbosockets 248
 3/8" Drive Universal..... 238-239
 1/2" Drive Combination Socket
 and Drive Tool Sets..... 260-271
 1/2" Drive Flare Nut
 Crowfoot Wrenches 279
 1/2" Drive Open End
 Crowfoot Wrenches 278
 1/2" Drive Deep..... 280, 284-285

1/2" Drive Drag Link..... 289

1/2" Hex Drivers 289

1/2" Drive Hex Bit 286-287

1/2" Drive Long Hex Bit 287

1/2" Drive Pentasocket..... 289

1/2" Drive Phillips® Bit 288

1/2" Drive Shallow .. 276-280, 282-283

1/2" Drive Slotted Bit 288

1/2" Drive Tools@Height.... 114-117

1/2" Drive Torx® Bit 288

1/2" Drive Turbosockets 286

3/4" Drive Combination Socket
 and Drive Tool Sets 301-303

3/4" Drive Deep 307

3/4" Drive Shallow 306-308

3/4" Drive Tools@Height.... 118-119

1" Drive Combination Socket
 and Drive Tool Sets..... 316-317

1" Drive Shallow 319

1" Drive Tools@Height 119

Multi Drive Socket
 and Drive Tool Sets 192, 197-200

Sockets and Sets, Impact
 3/8" Drive Deep 255-256, 258-259
 3/8" Drive Hex Bit 257
 3/8" Drive Shallow 254-257
 3/8" Drive TURBOSOCKET® 248
 3/8" Drive Universal Flex..... 254
 1/2" Drive Deep 296, 299
 1/2" Drive Hex Bit 301
 1/2" Drive Shallow..... 297, 295-301
 1/2" Drive TURBOSOCKET® 286
 1/2" Drive Universal Flex... 295-296
 3/4" Drive Budd
 Wheel Deep Length 6-pt 309
 3/4" Drive Deep 312
 3/4" Drive Hex Drivers 314-315
 3/4" Drive Shallow 310-311
 1" Drive Budd Wheel 320
 1" Drive Deep 323
 1" Drive Shallow 324
 1-1/2" Drive Shallow 325-326

Sockets, Drive Tools,
 and Sets, Tools@Height.... 109-119

Speeders
 1/4" Drive Chrome 204-205
 3/8" Drive Chrome 235
 1/2" Drive Chrome 273

Spinner Handle
 1/4" Drive..... 204-205
 3/8" Drive..... 235

Striking Wrenches
and Retainers 107, 182-184
Stud Remover..... 274

T

T-Handles

1/4" Drive Chrome 205
3/8" Drive Chrome 234
1/2" Drive Chrome 273
3/4" Drive Black 304
3/4" Drive Chrome 304
1" Drive Chrome 318
1-1/2" Drive Black 325

Tape Measure 486

Tape Measure, Tools@Height 136

Tethers & Lanyards..... 91-93

Tool Belts and Pouches 96

Tool Control Systems

Bulk Storage Cage 50

Keyless Tool Control Roll Cabinet..... 50

Tool Holsters..... 94

Tool Sets, Master (See Master Sets)

Tool Sets, Tools@Height..... 8-17, 80-89

Tool Storage Solutions

Bulk Storage Cage 50

Hand Carry, Canvas 489-491

Hand Carry, Metal 52-53

Heavy-Duty Service Cart..... 50

Job Site Boxes 51

Modular Industrial Storage... 38-45

Plastic Tool Boxes 489

Pouches 54

Professional Series Tool Storage 46-49

Roll Cabinets 46-49

Roll Cabinet with Bulk Storage 47

Service Carts 50

Socket Rails & Clips 84

Socket Set Toolboxes..... 52

Top Chests 46-49

Tool Organizers..... 491

Tool Storage Combinations 46-49

Tote Bags 52, 488-492

Tools@Height Hand Tools

1" Drive Sockets
and Drive Tools..... 119

1/2" Drive Sockets
and Drive Tools..... 114-116

1/4" Drive Sockets
and Drive Tools..... 109-110

3/4" Drive Sockets
and Drive Tools..... 118-119

3/8" Drive Sockets
and Drive Tools 111-113

Adjustable Wrenches 104

Box End Wrenches 101-102

Bull Pin With Position

Adjustable Shackle 121

C-Clamps 125

Click Type Torque Wrench 107

Combination Wrenches..... 98-99

Construction Adjustable Wrench ... 104

Construction, Single Head Wrenches . 104

Double Open End Angle

Head Wrenches 101

Feeler Gauges..... 135

Files 134

Flare Nut Wrenches 102-103

Flashlight 136

Grease Gun..... 136

Hacksaw Frames..... 133

Hammers..... 127-128

Hex Drivers, T-Handle 105

Hex Key Sets, Folding..... 108

Inspection Mirror 136

Level 136

Nutdrivers 121

Offset Pattern Box End

Striking Wrenches..... 106

Open-End Wrenches 101

Pick-up Tool..... 135

Pipe Wrenches 126

Pliers 122-125

Pry Bars..... 129

Punches & Chisels 130-132

Ratcheting Box Wrenches 102

Ratcheting Combination Wrenches 100

Saws..... 132-133

Scaffolding Ratchet 114

Scraper 133

Screwdrivers 120-121

Service Wrenches 103

Sledge Hammers 128

Slugging Wrench Retainers 107

Snips, Aviation 135

Spanner Wrenches, Adjustable Face... 105

Spanner Wrenches, Adjustable Hook.. 105

Spanner Wrenches, Adjustable Pin 105

Structural Wrenches, Single Head .. 104

Tape Measure 136

Torque Wrenches 108

Wedge With Postion

Adjustable Shackle 121

Wire Tools 124-125

**Tools@Height Tethers, Lanyards,
and Attachment Points**

Adjustable Wristbands 92

Anchor Straps..... 91

Belt Loops 96

Coil Tethers 92

Comfort Tool Belts..... 96

D-Rings 137

D-Ring Cord 138

Extra Deep Safe Buckets 97

Hard Body Safe Bucket Insert 97

Hard Hat Tethers 93

Heat Shrink Wrap 138

Holsters..... 94

Inspection Pouch..... 95

Lanyards..... 91

Micro D-Ring..... 138

Pullaway Wristbands..... 93

Quick Rings..... 138

Quick Spins..... 137

Quick Wrap Tape 138

Retractable Tethers 92

Safe Buckets 97

Small Parts Pouch 95

Tool Cinch Attachments 137

Tool Holsters 94

Tool Pouches 95

Utility Belts..... 96

Utility Pouch..... 95

Wristbands 93

Tools@Height, Master Sets

Tools@Height Master

Maintenance Tool Set 8, 80

Tools@Height Intermediate

Maintenance Service Set..... 9, 81

Tools@Height General

Maintenance Service Set..... 10, 82

Tools@Height Basic

Maintenance Service Set..... 11, 83

Tools@Height Basic Starter Plus Set. 12, 84

Tools@Height Basic Starter Set 12, 84

Tools@Height Ironworker's Toolkit.. 13, 85

Tools@Height Boilermaker's Toolkit.. 13, 86

Tools@Height High Rigging Toolkit... 13, 87

Tools@Height Pipefitter's

Foreman's Toolkit..... 14, 88

Tools@Height Individual

Pipefitter's Toolkit 14, 88

Tools@Height Pipefitter's

Gang Box Kit..... 14, 88

Tools@Height Electrician's Toolkit ... 15, 89
 Tools@Height Electrician's Crew Kit... 15, 89
 Scaffold Building Kit..... 90
 Torque Acquisition Meter, MULTITORQ... 58
 Torque Multipliers
 Replacement Square Drives 75
 Torque Multipliers - Plate Reaction 75
 Torque Multipliers with Handles..... 74
 Torque Screwdrivers
 T-Handle Fixed 62
 Preset Drive Tools, Torky 62
 TorqControl T-Handle Adjustable .. 62
 Torque Screwdrivers - Micro-Adjustable..... 63
 Torque Screwdrivers - Single Setting 63
 Torque Testers, Mechanical Comparator.... 59
 Torque Wrenches, Electronic 60-61
 Adjustable Torque Wrenches, Micrometer
 Comfort Grip 64
 Interchangeable Head 66
 Metal Handle Dual Scale..... 65
 Tools@Height Tethered..... 108
 Torque Wrenches, Single Setting
 (Pre-Set) Interchangeable Head 66
 Torque, Interchangeable Heads
 Adaptors..... 71
 Box End..... 70-72
 Fixed Square Drive..... 68
 Flare Nut 72-73
 Open End..... 68-69
 Ratcheting Square Drive..... 68
 Ratcheting Flare Nut..... 71
 Ratchet Wrench 71

U

Universal Joints, Hand
 1/4" Drive Chrome 205-206
 3/8" Drive Chrome 234-235
 1/2" Drive Chrome 274-275
 3/4" Drive Chrome 305
 Universal Joints, Impact
 3/8" Drive 253
 1/2" Drive 293
 3/4" Drive 309
 1" Drive 319-320
 1-1/2" Drive 325
 Utility Knives and Blades 499-500
 Utility Tool Sets
 Mini Pick and Hook Set 493
 Scraper and Pick Set 493

W

Wedges
 Set-up..... 494
 Wire Brush 481
 Wire Strippers 356-357
 Wood Chisels 483
 Work Gloves 504
 Worklight 502
 Wrenches and Sets
 30° Service Wrench 168
 Adjustable —
 see Adjustable Wrenches 175-177
 Basin Wrench..... 368
 Box End, Double Head 169-171
 Chain Pipe Wrench 369
 Combination, Black
 Industrial Finish..... 146-147
 Combination, Flex-Head,
 12-pt..... 153
 Combination, High Polish
 Finish..... 142-143, 148-149
 Combination, HI-VIS Red, 12-pt..... 150
 Combination, HI-VIS Yellow, 12-pt..... 151
 Combination, Miniature..... 152
 Combination, Offset, 12-pt 145-146
 Combination, Ratcheting,
 12-pt..... 154-160
 Combination, Ratcheting,
 Flex-Head, 12-pt..... 161
 Combination, Ratcheting,
 Stubby, 12-pt, 155, 160
 Combination, Short 152
 Combination, Stubby, 12-pt..... 153
 Combination, Supercombo®,
 Black Finish, 12-pt, 146-147
 Combination, Supercombo®,
 Chrome Finish, 6-pt..... 144
 Combination, Supercombo®,
 Chrome Finish, 12-pt..... 142-143, 148-149
 Construction, Adjustable 178
 Construction, Single Head ... 178-179
 Flare Nut, Double Head, Chrome.... 174-175
 Flare Nut, Ratcheting..... 174
 Flex Head, Double Box 153
 Hammer Wrenches 6-Point..... 184
 Hex Keys 186-187
 Hex Key Sets..... 188
 Hex Key Sets, T-Handle 187
 Hex Key Sets, Folding..... 187
 Insulated 517
 Open End, Double Angle Head,

Chrome 166
 Open End, Double Head,
 Chrome 162
 Open End, Double Head,
 Miniature..... 164-165
 Open End, Double Head,
 Short 163
 Pipe, Aluminum..... 366
 Pipe, Cast Iron 367
 Ratcheting Box End,
 Double Head, Offset..... 173
 Ratcheting Box End,
 Double Head, Straight 172-173
 Ratcheting Box End,
 Single Head, Straight..... 171-172
 Ratcheting Flare Nut,
 Single Head 174
 Service, 30° Angle Head..... 168
 Spanner, Adjustable Face 185
 Spanner, Adjustable Hook 185
 Spanner, Adjustable Pin..... 185
 Strap 368
 Striking Face, Offset..... 183
 Striking Face, Straight 182
 Striking Wrench Retainers..... 184
 Structural, Single Head..... 179
 Structural, Single Head Offset 179
 T-Handle Hex Wrenches 186
 Tools@Height Wrenches..... 98-107
 Tubular Handle, Offset Box..... 181
 Tubular Handle, Open End..... 180
 Tubular Handle, Straight Box 181
 Tubular Handles 180
 Wrenches, Micrometer Adjustable Torque
 Comfort Grip 64
 Interchangeable Head 66
 Metal Handle Dual Scale..... 65
 Tools@Height Tethered..... 108
 Wrecking Bars 497
 Wristbands, Tools@Height 93

WARRANTIES

Safety

Hand tools are generally designed to perform one function — do not use them improperly. Screwdrivers are not chisels, adjustable wrenches are not hammers and pliers are not intended to replace wrenches. Each of our product groups contains specific safety tips for proper tool usage. Additionally, wear appropriate clothing for the job, and always wear safety glasses. A special note on safety... use of hand sockets (chrome finish) with power drive (impact) equipment is a misuse of the tool and can result in serious injury.

Trademarks

The following are trademarks of Snap-on Incorporated in the United States, and some are registered in other countries. All other Snap-on trademarks, service marks, domain names, logos, and company names referred to in this catalog are either trademarks, registered trademarks, service marks, domain names, logos, company names of or are otherwise the property of Snap-on Incorporated or its affiliates. In countries where any of the Snap-on trademarks, service marks, domain names, logos and company names are not registered. Snap-on Incorporated claims other rights associated with unregistered trademarks, service marks, domain names, logos, and company names. Other product or company names referred to in this catalog may be trademarks of their respective owners.

Williams®

Wms.™

Bahco®

ERGO™

ENDUROGRIP™

SUPERECTOR™

SUPERBLACK™

SUPERCOMBO®

SUPER SOCKET™

SUPERRENCH®

SUPERTORQUE™

PHILLIPS®

TORX®

POZIDRIV®

ROBERTSON®

Limited Warranty:

Williams warrants that its products shall be free from defects in workmanship and materials (i) the duration described in each product's warranty statement; or (ii) as specifically provided in this Warranties Statement. In the case of any conflict between an individual product's warranty statement and this Warranties Statement, the individual product's warranty provided with the product shall apply. This warranty is limited to products purchased from authorized Williams distributors. The warranty duration depends upon the nature of the product. If the product information for purchased product does not include a warranty statement with the applicable duration or prior to a product purchase, a customer can obtain the product warranty statement and warranty duration from a selling Williams distributor or by writing Williams at the address provided at the end of this warranty statement. Williams, at its sole option, will repair, replace or grant a credit for product that does not comply with this warranty. The product must be returned to the Williams distributor from whom the product was purchased for warranty service. If the distributor is unavailable, the product should be returned to Williams, 6969 Jamesson Rd, Midland, GA 31820, freight prepaid. Include a contact name, phone number and a return address; please do not supply a post office box. If you choose not to (1) use a carrier that offers tracking or (2) insure or declare the full value of the product, you will be responsible for any loss or damage to the product during shipping. Williams does not provide any warranty for: 1) consumable products, 2) products subjected to abnormal use, or 3) normal wear and tear of products. Consumable products are goods reasonably expected to be used up or damaged during use. Abnormal use includes misuse, modification, accident, neglect or lack of maintenance. If the warranty claims is found to be invalid, the original product will be returned to the customer. By repairing or replacing a product, or providing a refund, Williams does not waive a claim that a Product nevertheless has been subject to abnormal use. Any products or parts replaced or for which Williams has provided a refund are the property of Williams and will not be returned.

Torque Products Warranty:

Williams warrants to the original purchaser of Williams Torque Products that the company's torque products are free from defects in workmanship and materials for the duration provided below. Williams will repair or replace Williams Torque Products which fail to give satisfactory service due to defective workmanship or materials (excluding calibration) for 12 months from the date of original purchase. Williams warrants "initial, out of box calibration" of each new, unused Williams Torque Product. Repair, replacement or recalibration, as applicable, shall be at the election and expense of Williams, and is your exclusive remedy in place of all other rights and remedies. Products must be returned with proof of purchase, freight prepaid, to a Williams Torque Products repair center for warranty service. Williams will repair or replace Williams Torque Multipliers which fail to give satisfactory service due to defective workmanship or material for 90 days from the date of original purchase. Williams does not provide any warranty for products subjected to abnormal use. Abnormal use includes misuse, accident, modification, unreasonable use, neglect, lack of maintenance, or use after the tool is significantly worn.

Toolbox Warranties:

All toolboxes sold under the Williams brand will be warranted for a period of one (1) year from the date of purchase against defects in materials and workmanship. Any part(s) which are determined by Williams to be defective in material or workmanship, will be, at Williams discretion, repaired, replaced, or granted a credit. Any toolboxes that are to be returned, must be done through Williams current Return Goods Policy, be sent back freight prepaid, and accompanied with a dated copy of the purchase order. Williams does NOT provide any warranty for products subjected to "abnormal use". Products that are not labeled Williams or Bahco are subject to the warranty provided by the manufacturers of those products and Williams will pass along any such warranties. "Abnormal use" includes misuse, accident, modification, unreasonable use, abuse, neglect, lack of maintenance, use in product-related service, or use after the product is significantly worn. Abnormal use of tool storage units also includes, without limitation, situations when a unit is pulled using a mechanical vehicle, rolled over large drops, used in a highly corrosive environment, used as a step stool, modified with non-Snap-on parts, overloaded or modified in any way.

TO THE EXTENT ALLOWED BY APPLICABLE LAW, THIS WARRANTY IS IN LIEU OF ALL OTHER WARRANTIES, EXPRESSED OR IMPLIED, INCLUDING THE IMPLIED WARRANTIES OF MERCHANTABILITY AND FITNESS FOR A PARTICULAR PURPOSE. WILLIAMS AND ITS AFFILIATED COMPANIES SHALL NOT BE LIABLE FOR ANY INCIDENTAL, SPECIAL OR CONSEQUENTIAL COSTS OR DAMAGES INCURRED BY THE PURCHASER OR OTHERS.

This warranty gives you specific legal rights, and you may also have other rights which vary from state to state or country.

Williams
Warranty Information Center
6969 Jamesson Road
Midland, GA 31820



Snap-on Industrial is a division of IDSC Holdings, LLC



WILLIAMS®

USA CUSTOMER SERVICE

TOLL FREE: USA 800-446-7404

FAX: 800-877-5687

Email: williams@snapon.com

SALES HEADQUARTERS

Williams

2801 80th Street
Kenosha, WI 53143

CANADA CUSTOMER SERVICE

TOLL FREE: 800-296-4787

FAX: 888-447-8665

Email: canadawilliams@snapon.com

DISTRIBUTION CENTER

Williams

6969 Jamesson Road
Midland, GA 31820

WILLIAMS-INDUSTRIAL.COM